



# THE DATASHEET OF IRC530PBF



# IRC530PbF

## HEXFET® Power MOSFET

- Dynamic dv/dt Rating
- Repetitive Avalanche Rated
- Current Sense
- 175°C Operating Temperature
- Fast Switching
- Ease of Paralleling
- Simple Drive Requirements
- Lead-Free

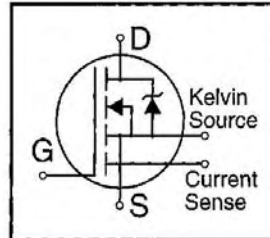

$V_{DSS} = 100V$
$R_{DS(on)} = 0.16\Omega$
$I_D = 14A$

### Description

Third Generation HEXFETs from International Rectifier provide the designer with the best combination of fast switching, ruggedized device design, low on-resistance and cost-effectiveness.

The HEXSense device provides an accurate fraction of the drain current through the additional two leads to be used for control or protection of the device. These devices exhibit similar electrical and thermal characteristics as their IRF-series equivalent part numbers. The provision of a kelvin source connection effectively eliminates problems of common source inductance when the HEXSense is used as a fast, high-current switch in non current-sensing applications.

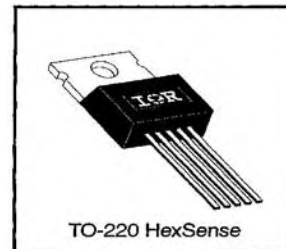

### Absolute Maximum Ratings

	Parameter	Max.	Units
$I_D @ T_C = 25^\circ C$	Continuous Drain Current, $V_{GS} @ 10 V$	14	A
$I_D @ T_C = 100^\circ C$	Continuous Drain Current, $V_{GS} @ 10 V$	10	
$I_{DM}$	Pulsed Drain Current ①	56	
$P_D @ T_C = 25^\circ C$	Power Dissipation	88	W
	Linear Derating Factor	0.59	W/°C
$V_{GS}$	Gate-to-Source Voltage	$\pm 20$	V
$E_{AS}$	Single Pulse Avalanche Energy ②	69	mJ
$I_{AR}$	Avalanche Current ①	14	A
$E_{AR}$	Repetitive Avalanche Energy ①	8.8	mJ
dv/dt	Peak Diode Recovery dv/dt ③	5.5	V/ns
$T_J$ $T_{STG}$	Operating Junction and Storage Temperature Range	-55 to +175	°C
	Soldering Temperature, for 10 seconds	300 (1.6mm from case)	
	Mounting Torque, 6-32 or M3 screw	10 lbf•in (1.1 N•m)	

### Thermal Resistance

	Parameter	Min.	Typ.	Max.	Units
$R_{\theta JC}$	Junction-to-Case	—	—	1.7	°C/W
$R_{\theta CS}$	Case-to-Sink, Flat, Greased Surface	—	0.50	—	
$R_{\theta JA}$	Junction-to-Ambient	—	—	62	

### Electrical Characteristics @ T<sub>J</sub> = 25°C (unless otherwise specified)

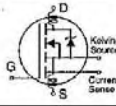
	Parameter	Min.	Typ.	Max.	Units	Test Conditions
V <sub>(BR)DSS</sub>	Drain-to-Source Breakdown Voltage	100	—	—	V	V <sub>GS</sub> =0V, I <sub>D</sub> = 250μA
ΔV <sub>(BR)DSS</sub> /ΔT <sub>J</sub>	Breakdown Voltage Temp. Coefficient	—	0.12	—	V/°C	Reference to 25°C, I <sub>D</sub> = 1mA
R <sub>DS(on)</sub>	Static Drain-to-Source On-Resistance	—	—	0.16	Ω	V <sub>GS</sub> =10V, I <sub>D</sub> =8.4A ④
V <sub>GS(th)</sub>	Gate Threshold Voltage	2.0	—	4.0	V	V <sub>DS</sub> =V <sub>GS</sub> , I <sub>D</sub> = 250μA
g <sub>fs</sub>	Forward Transconductance	4.7	—	—	S	V <sub>DS</sub> =50V, I <sub>D</sub> =8.4A ④
I <sub>DSS</sub>	Drain-to-Source Leakage Current	—	—	25	μA	V <sub>DS</sub> =100V, V <sub>GS</sub> =0V
		—	—	250		V <sub>DS</sub> =80V, V <sub>GS</sub> =0V, T <sub>J</sub> =150°C
I <sub>GSS</sub>	Gate-to-Source Forward Leakage	—	—	100	nA	V <sub>GS</sub> =20V
	Gate-to-Source Reverse Leakage	—	—	-100		V <sub>GS</sub> =-20V
Q <sub>g</sub>	Total Gate Charge	—	—	26	nC	I <sub>D</sub> =14A
Q <sub>gs</sub>	Gate-to-Source Charge	—	—	5.5		V <sub>DS</sub> =80V
Q <sub>gd</sub>	Gate-to-Drain ("Miller") Charge	—	—	11		V <sub>GS</sub> =10V See Fig. 6 and 13 ④
t <sub>d(on)</sub>	Turn-On Delay Time	—	9.5	—	ns	V <sub>DD</sub> =50V
t <sub>r</sub>	Rise Time	—	42	—		I <sub>D</sub> =14A
t <sub>d(off)</sub>	Turn-Off Delay Time	—	22	—		R <sub>G</sub> =12Ω
t <sub>f</sub>	Fall Time	—	25	—		R <sub>D</sub> =3.5Ω See Figure 10 ④
L <sub>D</sub>	Internal Drain Inductance	—	4.5	—	nH	Between lead, 6 mm (0.25in.) from package and center of die contact
L <sub>S</sub>	Internal Source Inductance	—	7.5	—		
C <sub>iss</sub>	Input Capacitance	—	700	—	pF	V <sub>GS</sub> =0V
C <sub>oss</sub>	Output Capacitance	—	320	—		V <sub>DS</sub> =25V
C <sub>rss</sub>	Reverse Transfer Capacitance	—	83	—		f=1.0MHz See Figure 5
r	Current Sensing Ratio	1390	—	1540	—	I <sub>D</sub> =14A, V <sub>GS</sub> =10V
C <sub>oss</sub>	Output Capacitance of Sensing Cells	—	9.0	—	pF	V <sub>GS</sub> =0V, V <sub>DS</sub> = 25V, f=1.0MHz

### Source-Drain Ratings and Characteristics

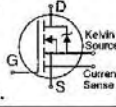
	Parameter	Min.	Typ.	Max.	Units	Test Conditions
I <sub>S</sub>	Continuous Source Current (Body Diode)	—	—	14	A	MOSFET symbol showing the integral reverse p-n junction diode. 
I <sub>SM</sub>	Pulsed Source Current (Body Diode) ①	—	—	56		
V <sub>SD</sub>	Diode Forward Voltage	—	—	2.5	V	T <sub>J</sub> =25°C, I <sub>S</sub> =14A, V <sub>GS</sub> =0V ④
t <sub>rr</sub>	Reverse Recovery Time	—	150	310	ns	T <sub>J</sub> =25°C, I <sub>F</sub> =14A
Q <sub>rr</sub>	Reverse Recovery Charge	—	0.85	1.2	μC	di/dt=100A/μs ④
t <sub>on</sub>	Forward Turn-On Time	Intrinsic turn-on time is negligible (turn-on is dominated by L <sub>S</sub> +L <sub>D</sub> )				

#### Notes:

- ① Repetitive rating; pulse width limited by max. junction temperature (See Figure 11)
- ② V<sub>DD</sub>=25V, starting T<sub>J</sub>=25°C, L=528μH R<sub>G</sub>=25Ω, I<sub>AS</sub>=14A (See Figure 12)
- ③ I<sub>SD</sub>≤14A, di/dt≤140A/μs, V<sub>DD</sub>≤V<sub>(BR)DSS</sub>, T<sub>J</sub>≤175°C
- ④ Pulse width ≤ 300 μs; duty cycle ≤2%.

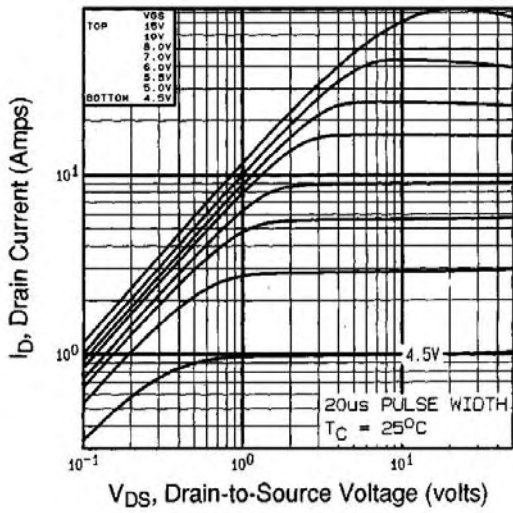

**Fig 1.** Typical Output Characteristics,  
 $T_C=25^\circ\text{C}$

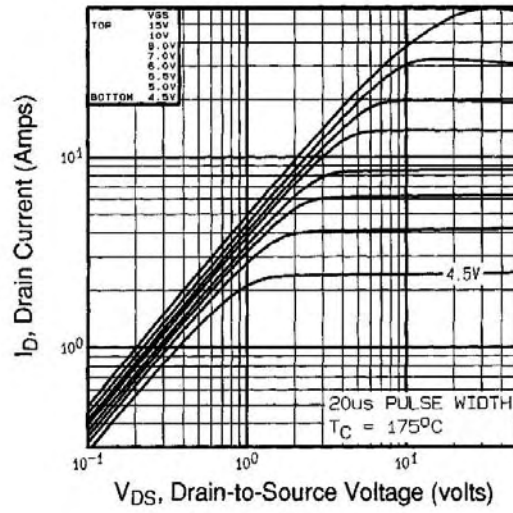

**Fig 2.** Typical Output Characteristics,  
 $T_C=175^\circ\text{C}$

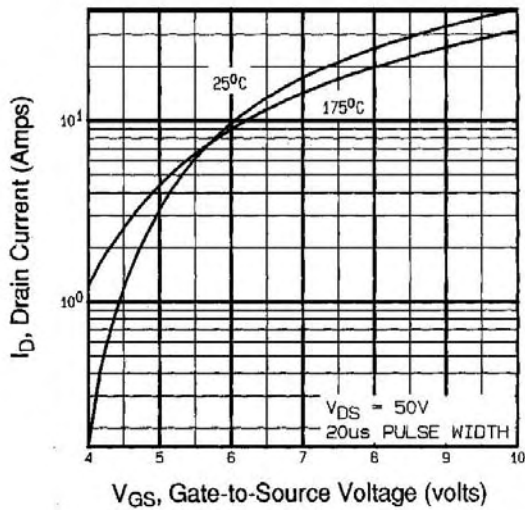

**Fig 3.** Typical Transfer Characteristics

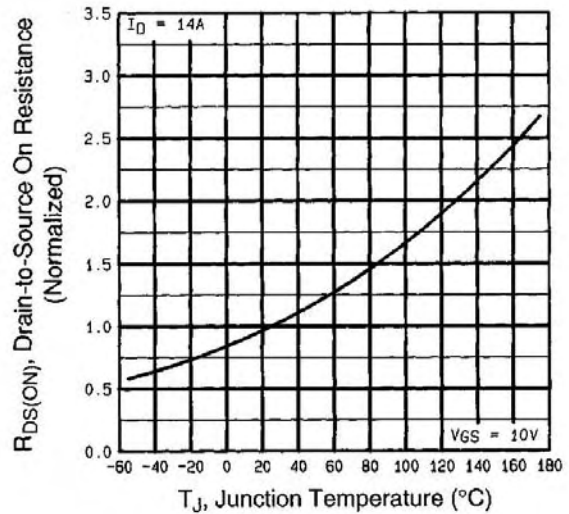

**Fig 4.** Normalized On-Resistance  
Vs. Temperature

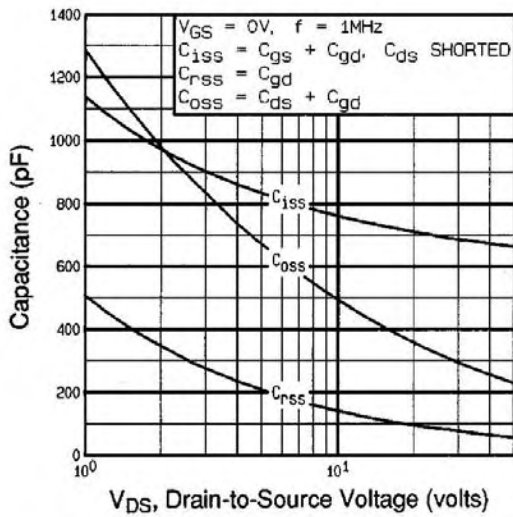

**Fig 5.** Typical Capacitance Vs. Drain-to-Source Voltage

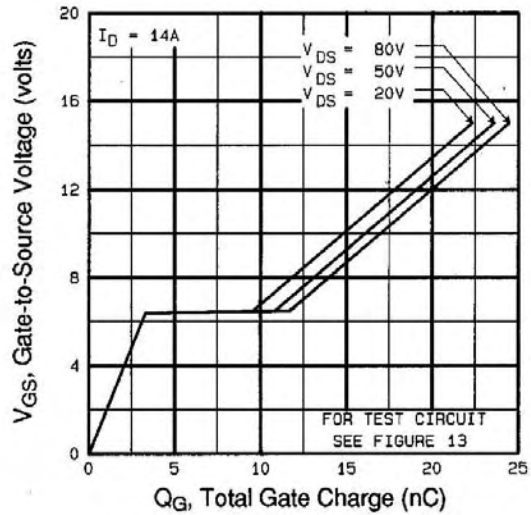

**Fig 6.** Typical Gate Charge Vs. Gate-to-Source Voltage

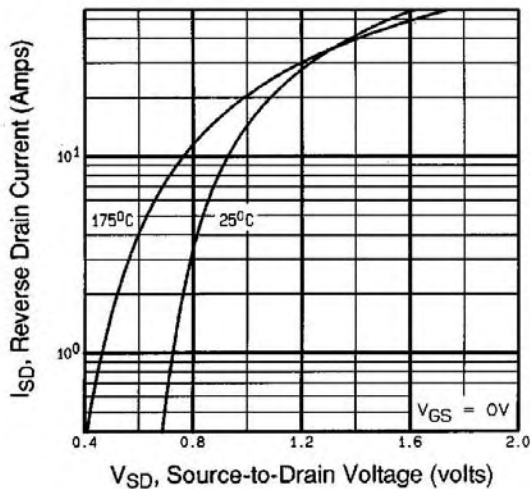

**Fig 7.** Typical Source-Drain Diode Forward Voltage

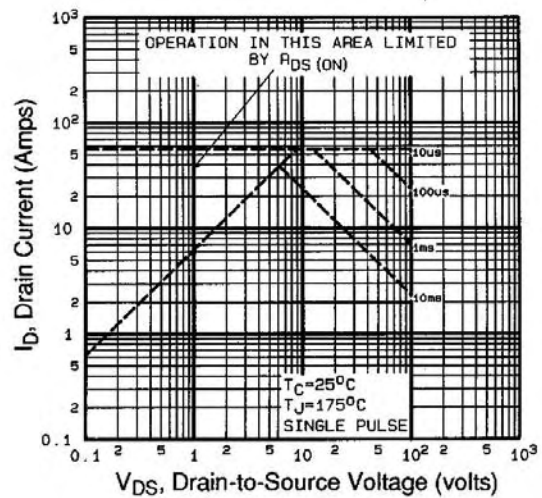

**Fig 8.** Maximum Safe Operating Area

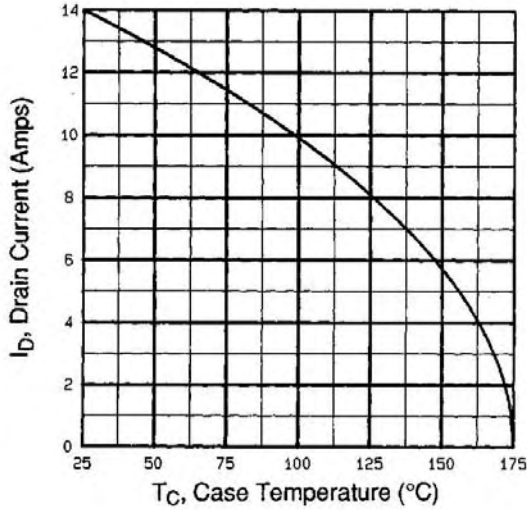

**Fig 9.** Maximum Drain Current Vs. Case Temperature

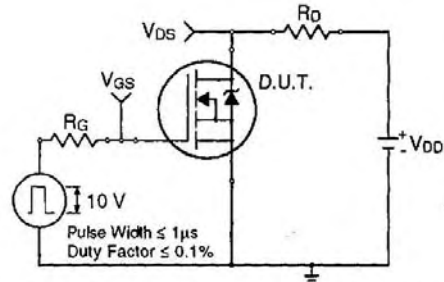

**Fig 10a.** Switching Time Test Circuit

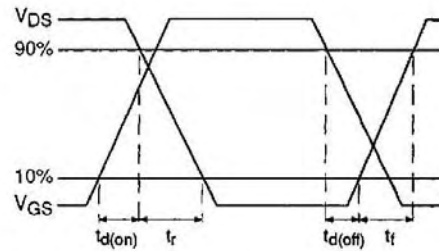

**Fig 10b.** Switching Time Waveforms

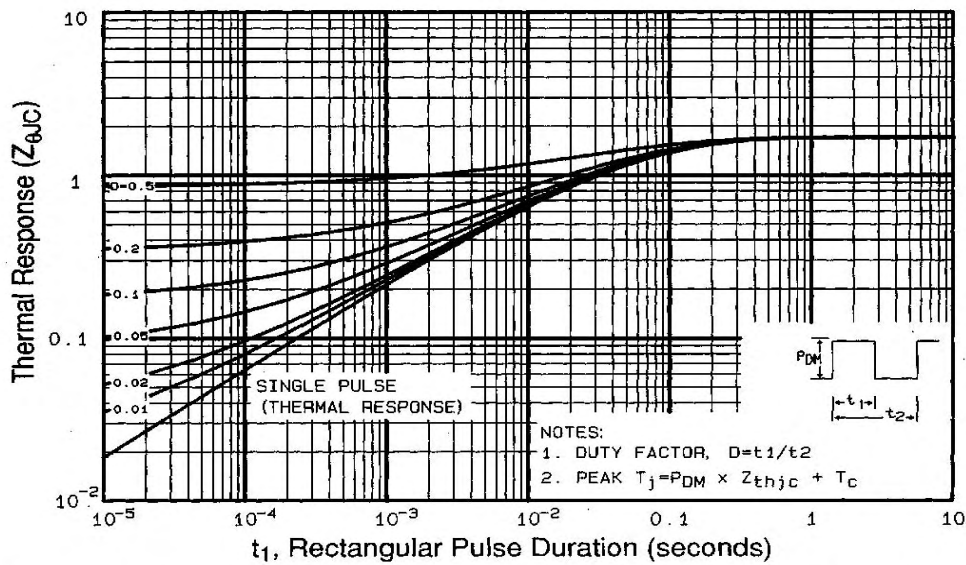

**Fig 11.** Maximum Effective Transient Thermal Impedance, Junction-to-Case  
www.irf.com

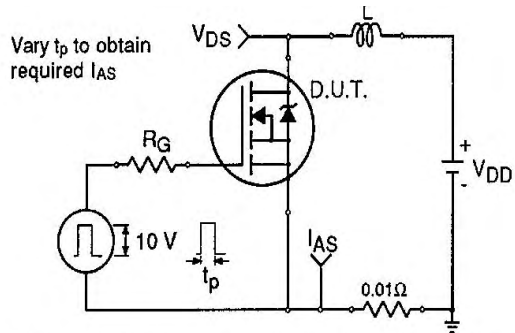

**Fig 12a.** Unclamped Inductive Test Circuit

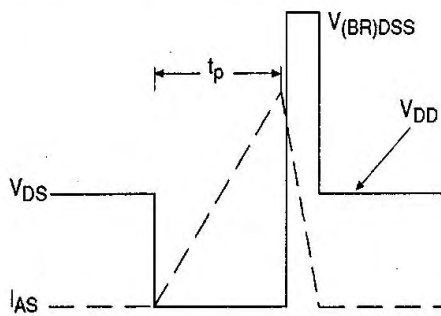

**Fig 12b.** Unclamped Inductive Waveforms

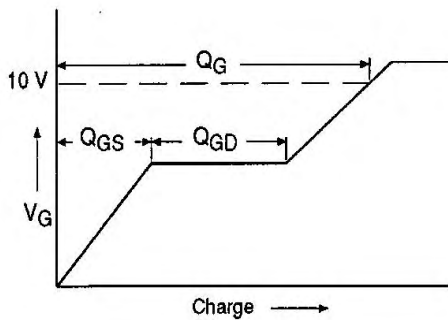

**Fig 13a.** Basic Gate Charge Waveform

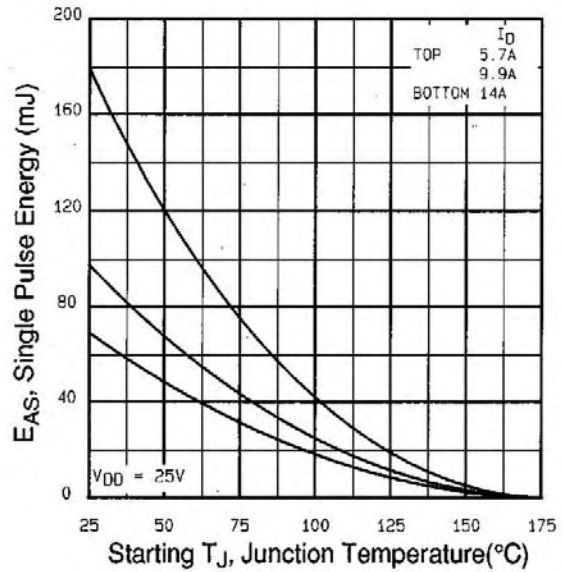

**Fig 12c.** Maximum Avalanche Energy Vs. Drain Current

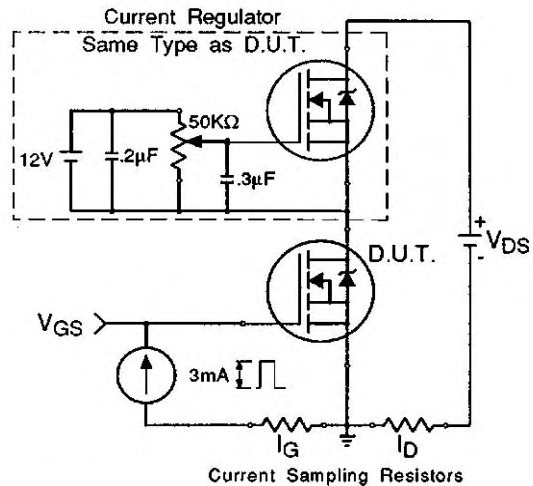

**Fig 13b.** Gate Charge Test Circuit

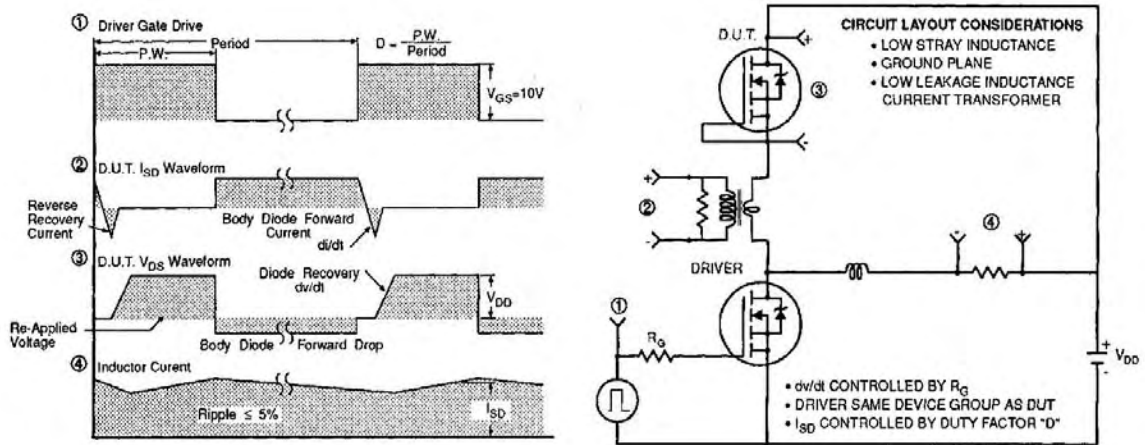

Fig 14. Peak Diode Recovery  $dv/dt$  Test Circuit

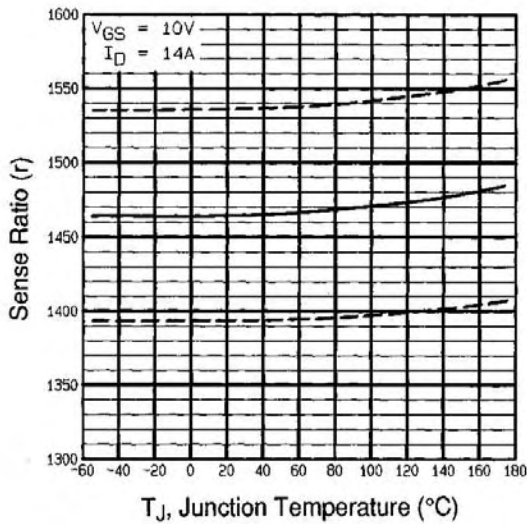

Fig 15. Typical HEXSense Ratio Vs. Junction Temperature

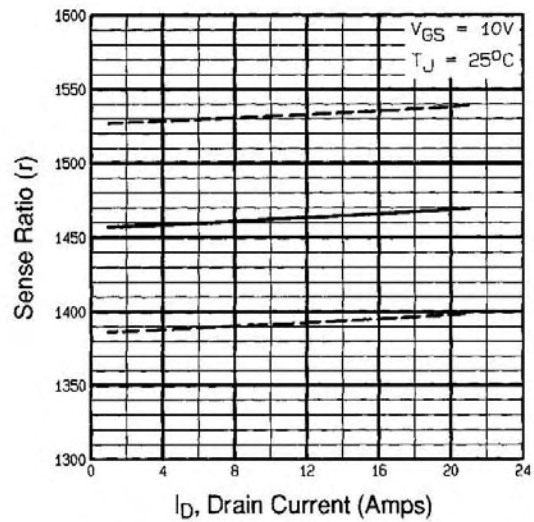

Fig 16. Typical HEXSense Ratio Vs. Drain Current

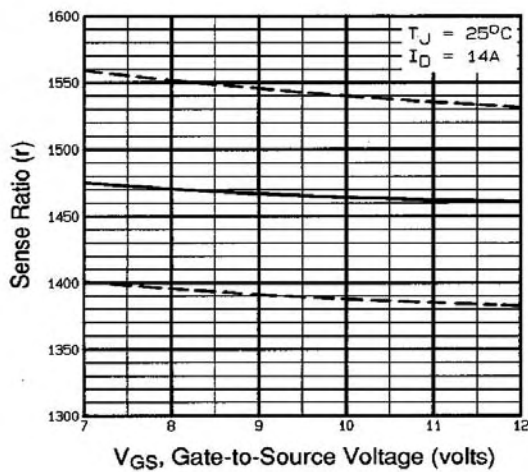
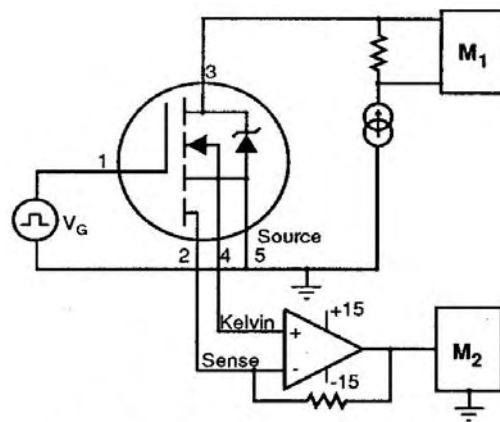

Fig 17. Typical HEXSense Ratio Vs. Gate Voltage



M1, M2 = HIGH SPEED DIGITAL VOLTMETERS

Fig 18. HEXSense Ratio Test Circuit

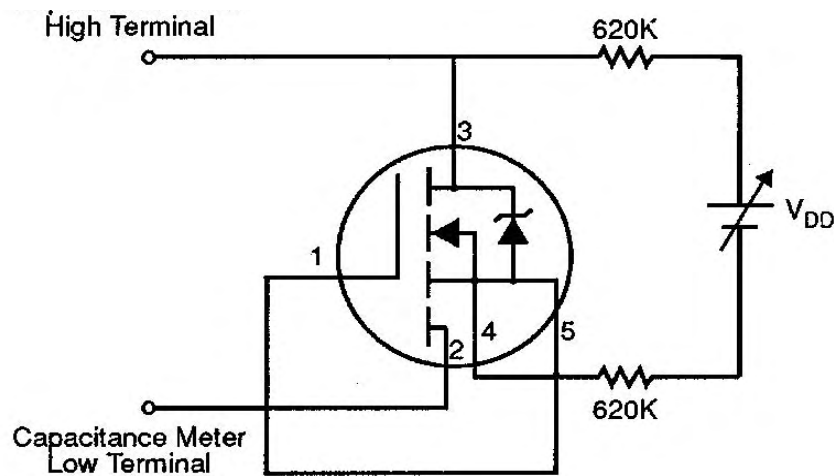
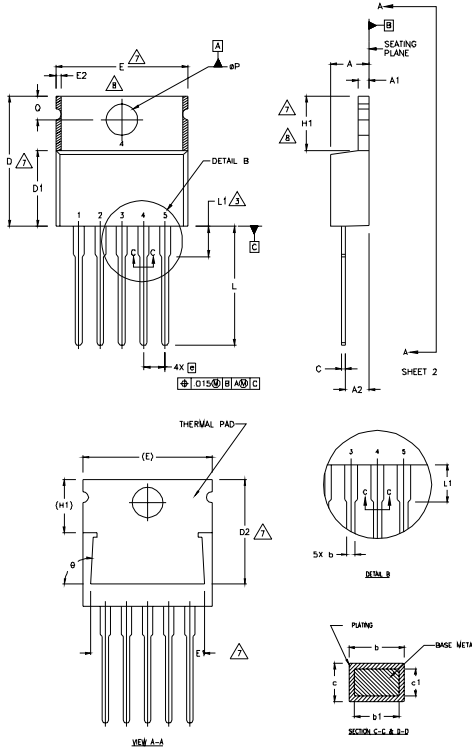

Fig 19. HEXSense Sensing Cell Output Capacitance Test Circuit

## HexsenseTO-220 5L Package Outline

( Dimensions are shown in millimeters (inches) )



**NOTES:**

- 1 DIMENSIONING AND TOLERANCING PER ASME Y14.5 M- 1994.
- 2 DIMENSIONS ARE SHOWN IN INCHES [MILLIMETERS].
- 3 LEAD DIMENSION AND FINISH UNCONTROLLED IN L1.
- 4 DIMENSION D & E DO NOT INCLUDE MOLD FLASH. MOLD FLASH SHALL NOT EXCEED .005" (0.127) PER SIDE. THESE DIMENSIONS ARE MEASURED AT THE OUTERMOST EXTREMES OF THE PLASTIC BODY.
- 5 DIMENSION b1 & c1 APPLY TO BASE METAL ONLY.
- 6 CONTROLLING DIMENSION : INCHES.
- 7 THERMAL PAD CONTOUR OPTIONAL WITHIN DIMENSIONS E,H1,D2 & E1
- 8 DIMENSION E2 X H1 DEFINE A ZONE WHERE STAMPING AND SINGULATION IRREGULARITIES ARE ALLOWED.

SYMBOL	DIMENSIONS				NOTES
	MILLIMETERS		INCHES		
	MIN.	MAX.	MIN.	MAX.	
A	3.56	4.82	.140	.190	
A1	0.51	1.40	.020	.055	
A2	2.04	2.92	.080	.115	
b	0.64	0.88	.025	.035	
b1	0.64	0.84	.025	.033	5
c	0.36	0.61	.014	.024	
c1	0.36	0.56	.014	.022	5
D	14.22	16.51	.560	.650	4
D1	8.38	9.02	.330	.355	
D2	12.19	12.88	.480	.507	7
E	9.66	10.66	.380	.420	4,7
E1	8.38	8.89	.330	.350	7
e	1.70 BSC		.067 BSC		
H1	5.85	6.55	.230	.270	7,8
L	13.47	14.09	.530	.555	
L1	-	6.35	-	.250	3
øP	3.54	4.08	.139	.161	
Q	2.54	3.42	.100	.135	
ø	90°-93°		90°-93°		

## Hexsense TO-220 5L Part Marking Information

EXAMPLE: THIS IS AN IRC640  
 WITH ASSEMBLY  
 LOT CODE 1789  
 ASSEMBLED ON WW 19, 1997  
 IN THE ASSEMBLY LINE "C"

Note: "P" in assembly line position  
 indicates "Lead-Free"

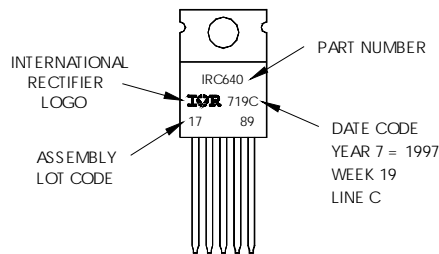

Data and specifications subject to change without notice.

## Looking for pricing, stock, or lifecycle information?

Click below to explore more details on WIN SOURCE:

 [View IRC530PBF on WIN SOURCE](#)

 [Vishay Information](#)

## Optimize Your Supply Chain with WIN SOURCE Solutions

-  Global Sourcing Solution
-  Obsolete Management
-  Cost Control Management
-  Shortage Management
-  Alternative Solution
-  Excess Inventory Management