



**THE DATASHEET OF
APT53N60BC6**





Super Junction MOSFET

- Ultra Low $R_{DS(ON)}$
- Low Miller Capacitance
- Ultra Low Gate Charge, Q_g
- Avalanche Energy Rated
- Extreme dv/dt Rated
- Popular TO-247 or Surface Mount D³ package.

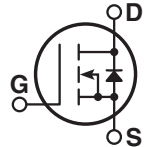
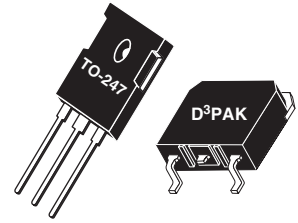

MAXIMUM RATINGS

All Ratings per die: $T_C = 25^\circ\text{C}$ unless otherwise specified.

| Symbol | Parameter | APT53N60B_SC6 | UNIT |
|----------------|---|---------------|------------------|
| V_{DSS} | Drain-Source Voltage | 600 | Volts |
| I_D | Continuous Drain Current @ $T_C = 25^\circ\text{C}$ | 53 | Amps |
| | Continuous Drain Current @ $T_C = 100^\circ\text{C}$ | 34 | |
| I_{DM} | Pulsed Drain Current ¹ | 159 | |
| V_{GS} | Gate-Source Voltage Continuous | ± 20 | Volts |
| P_D | Total Power Dissipation @ $T_C = 25^\circ\text{C}$ | 417 | Watts |
| T_J, T_{STG} | Operating and Storage Junction Temperature Range | - 55 to 150 | $^\circ\text{C}$ |
| T_L | Lead Temperature: 0.063" from Case for 10 Sec. | 260 | |
| I_{AR} | Avalanche Current ² | 9.3 | Amps |
| E_{AR} | Repetitive Avalanche Energy ² ($I_D = 9.3\text{A}, V_{DD} = 50\text{V}$) | 1.72 | mJ |
| E_{AS} | Single Pulse Avalanche Energy ($I_D = 9.3\text{A}, V_{DD} = 50\text{V}$) | 1135 | |

STATIC ELECTRICAL CHARACTERISTICS

| Symbol | Characteristic / Test Conditions | MIN | TYP | MAX | UNIT |
|--------------|---|-----|-----|-----------|---------------|
| $BV_{(DSS)}$ | Drain-Source Breakdown Voltage ($V_{GS} = 0\text{V}, I_D = 250\mu\text{A}$) | 600 | | | Volts |
| $R_{DS(on)}$ | Drain-Source On-State Resistance ³ ($V_{GS} = 10\text{V}, I_D = 25.8\text{A}$) | | | 0.070 | Ohms |
| I_{DSS} | Zero Gate Voltage Drain Current ($V_{DS} = 600\text{V}, V_{GS} = 0\text{V}$) | | | 25 | μA |
| | Zero Gate Voltage Drain Current ($V_{DS} = 600\text{V}, V_{GS} = 0\text{V}, T_C = 150^\circ\text{C}$) | | | 250 | |
| I_{GSS} | Gate-Source Leakage Current ($V_{GS} = \pm 20\text{V}, V_{DS} = 0\text{V}$) | | | ± 100 | nA |
| $V_{GS(th)}$ | Gate Threshold Voltage ($V_{DS} = V_{GS}, I_D = 1.72\text{mA}$) | 2.5 | 3 | 3.5 | Volts |

 CAUTION: These Devices are Sensitive to Electrostatic Discharge. Proper Handling Procedures Should Be Followed.

"COOLMOS™ comprise a new family of transistors developed by Infineon Technologies AG. "COOLMOS" is a trademark of Infineon Technologies AG."

Microsemi Website - <http://www.microsemi.com>

| Symbol | Characteristic | Test Conditions | MIN | TYP | MAX | UNIT |
|---------------------|---------------------------------------|--|-----|------|-----|------|
| C _{iss} | Input Capacitance | V _{GS} = 0V V _{DS} = 25V f = 1 MHz | | 4020 | | pF |
| C _{oss} | Output Capacitance | | | 3545 | | |
| C _{rss} | Reverse Transfer Capacitance | | | 330 | | |
| Q _g | Total Gate Charge ⁴ | V _{GS} = 10V V _{DD} = 300V I _D = 53A @ 25°C | | 154 | | nC |
| Q _{gs} | Gate-Source Charge | | | 26 | | |
| Q _{gd} | Gate-Drain ("Miller") Charge | | | 82 | | |
| t _{d(on)} | Turn-on Delay Time | INDUCTIVE SWITCHING V _{GS} = 15V V _{DD} = 400V I _D = 53A @ 125°C R _G = 4.3Ω | | 14 | | ns |
| t _r | Rise Time | | | 36 | | |
| t _{d(off)} | Turn-off Delay Time | | | 151 | | |
| t _f | Fall Time | | | 74 | | |
| E _{on} | Turn-on Switching Energy ⁵ | INDUCTIVE SWITCHING @ 25°C V _{DD} = 400V, V _{GS} = 15V I _D = 53A, R _G = 4.3Ω | | 960 | | μJ |
| E _{off} | Turn-off Switching Energy | | | 873 | | |
| E _{on} | Turn-on Switching Energy ⁵ | INDUCTIVE SWITCHING @ 125°C V _{DD} = 400V, V _{GS} = 15V I _D = 53A, R _G = 4.3Ω | | 1478 | | |
| E _{off} | Turn-off Switching Energy | | | 995 | | |

SOURCE-DRAIN DIODE RATINGS AND CHARACTERISTICS

| Symbol | Characteristic / Test Conditions | MIN | TYP | MAX | UNIT |
|------------------|--|-----------------------|-----|-----|-------|
| I _S | Continuous Source Current (Body Diode) | | | 46 | Amps |
| I _{SM} | Pulsed Source Current ¹ (Body Diode) | | | 159 | |
| V _{SD} | Diode Forward Voltage ³ (V _{GS} = 0V, I _S = -53A) | | 0.9 | 1.2 | Volts |
| dv/dt | Peak Diode Recovery ⁶ | | | 15 | V/ns |
| t _{rr} | Reverse Recovery Time (I _S = -53A, di/dt = 100A/μs) | T _J = 25°C | | 795 | ns |
| Q _{rr} | Reverse Recovery Charge (I _S = -53A, di/dt = 100A/μs) | T _J = 25°C | | 25 | μC |
| I _{RRM} | Peak Recovery Current (I _S = -53A, di/dt = 100A/μs) | T _J = 25°C | | 58 | Amps |

THERMAL CHARACTERISTICS

| Symbol | Characteristic | MIN | TYP | MAX | UNIT |
|------------------|---------------------|-----|-----|------|------|
| R _{θJC} | Junction to Case | | | 0.30 | °C/W |
| R _{θJA} | Junction to Ambient | | | 40 | |

- 1 Repetitive Rating: Pulse width limited by maximum junction temperature
- 2 Repetitive avalanche causes additional power losses that can be calculated as $P_{AV} = E_{AR} \cdot f$. Pulse width tp limited by Tj max.
- 3 Pulse Test: Pulse width < 380 μs, Duty Cycle < 2%
- 4 See MIL-STD-750 Method 3471
- 5 Eon includes diode reverse recovery.
- 6 Maximum 125°C diode commutation speed = di/dt 600A/μs

Microsemi reserves the right to change, without notice, the specifications and information contained herein.

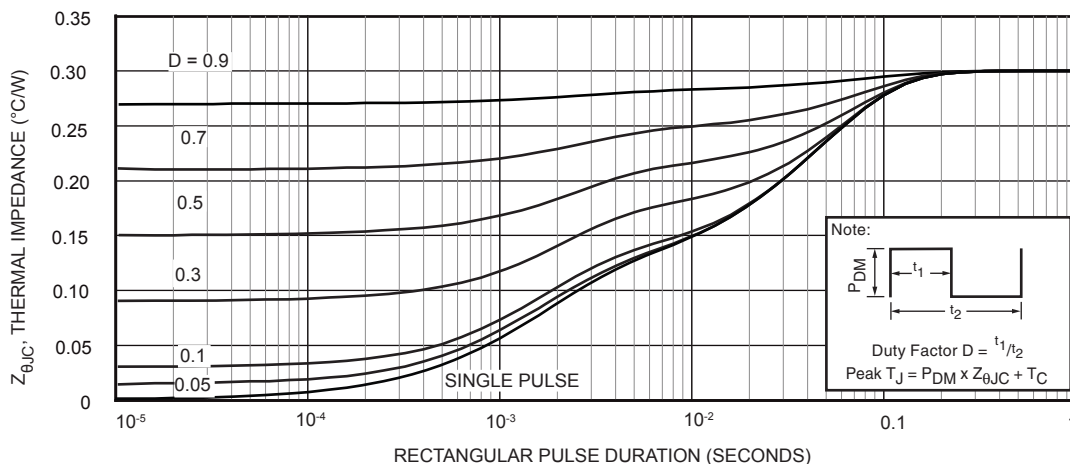

Figure 1, Maximum Effective Transient Thermal Impedance, Junction-To-Case vs Pulse Duration

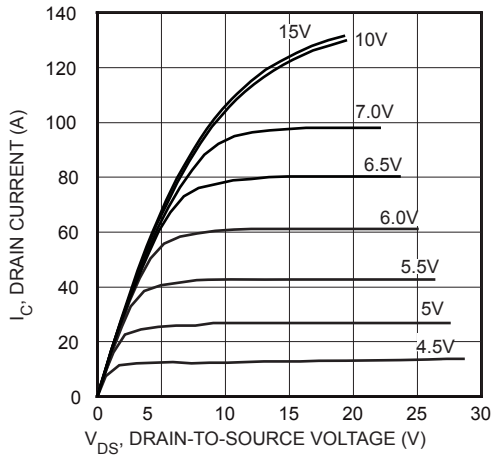

FIGURE 2, Low Voltage Output Characteristics

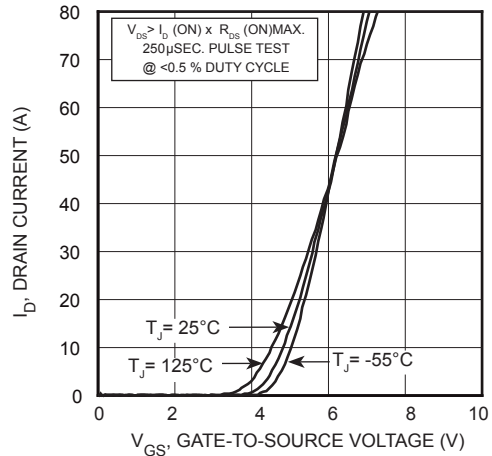

FIGURE 3, Transfer Characteristics

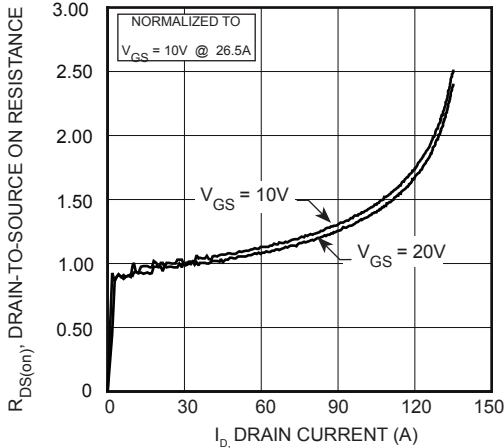

FIGURE 4, $R_{DS(ON)}$ vs Drain Current

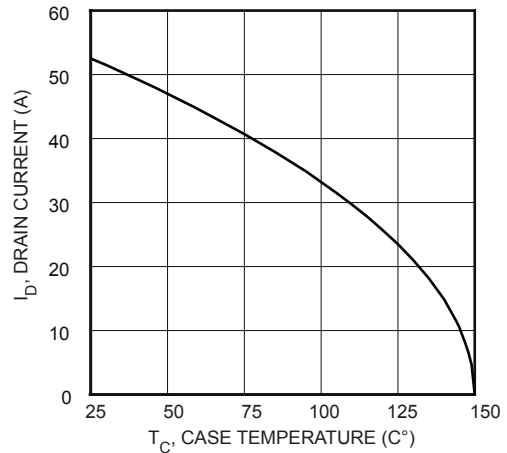

FIGURE 5, Maximum Drain Current vs Case Temperature

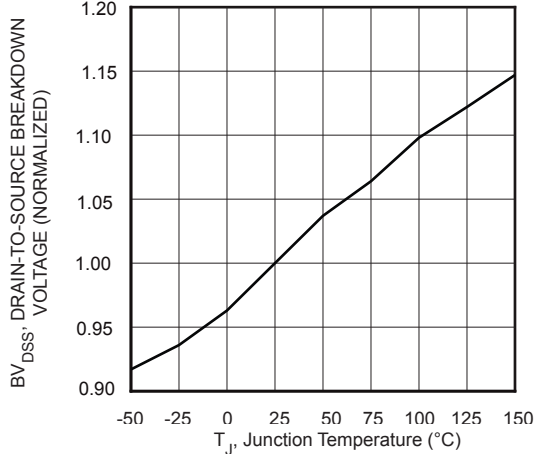

FIGURE 6, Breakdown Voltage vs Temperature

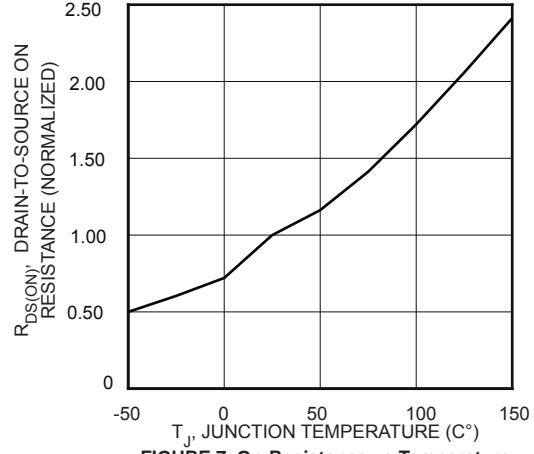

FIGURE 7, On-Resistance vs Temperature

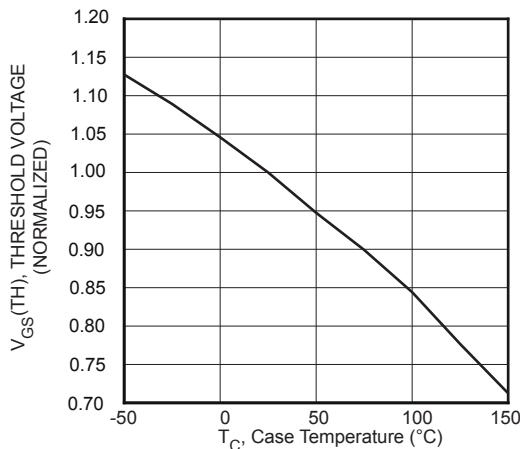

FIGURE 8, Threshold Voltage vs Temperature

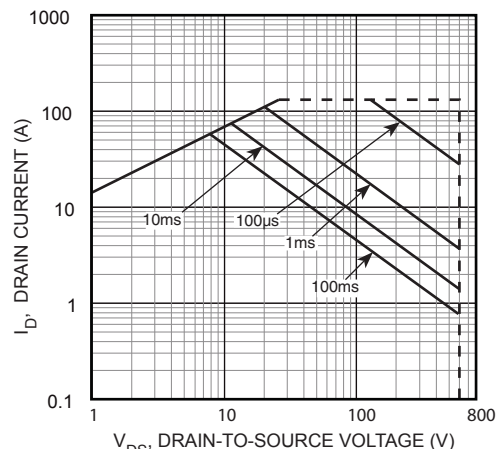

FIGURE 9, Maximum Safe Operating Area

Typical Performance Curves

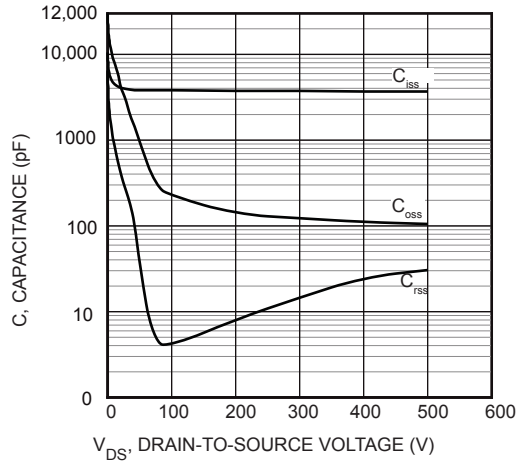

FIGURE 10, Capacitance vs Drain-To-Source Voltage

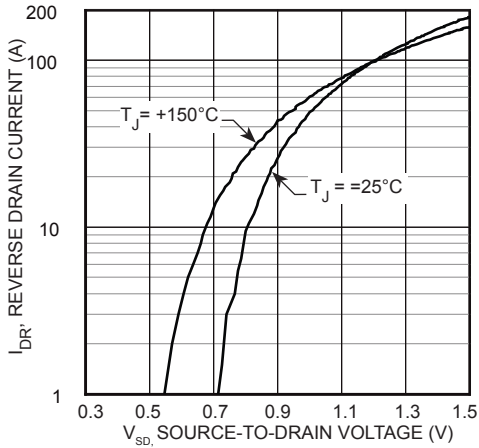

FIGURE 12, Source-Drain Diode Forward Voltage

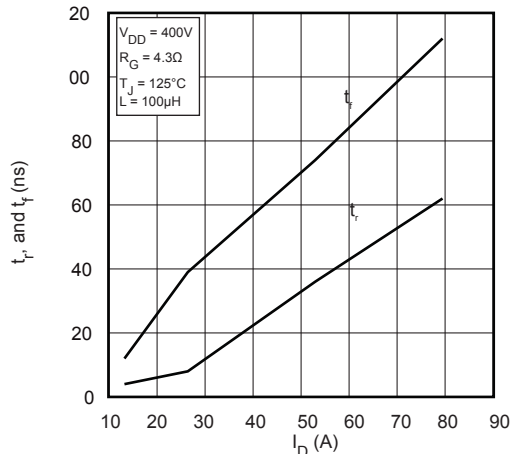

FIGURE 14, Rise and Fall Times vs Current

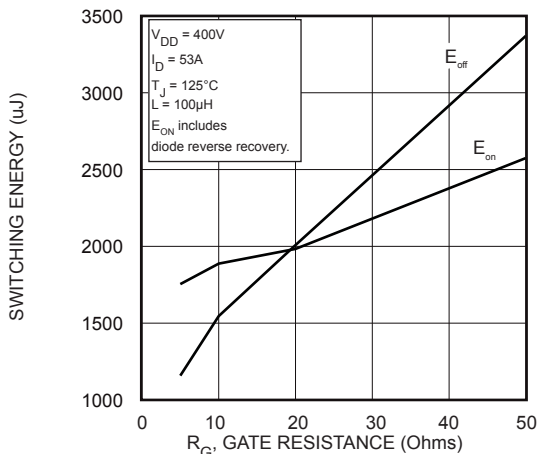

FIGURE 16, Switching Energy vs Gate Resistance

APT53N60B_SC6

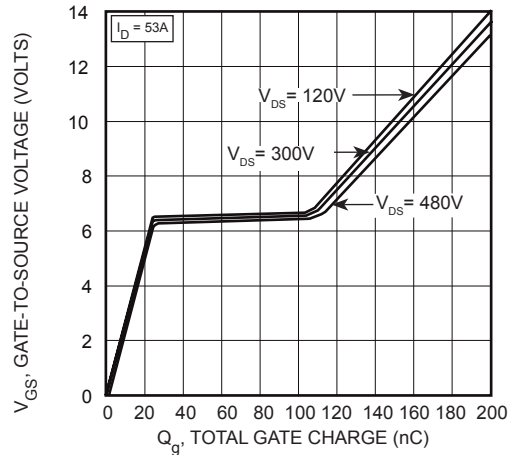

FIGURE 11, Gate Charges vs Gate-To-Source Voltage

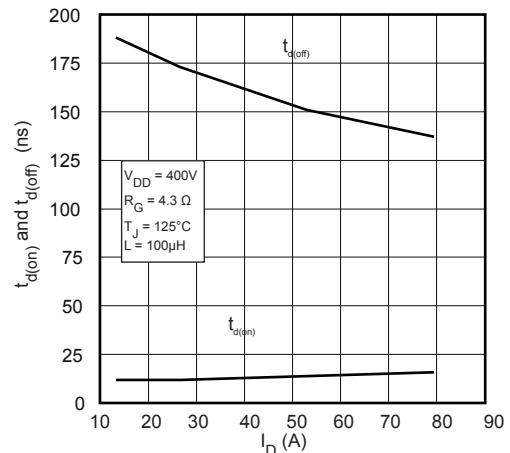

FIGURE 13, Delay Times vs Current

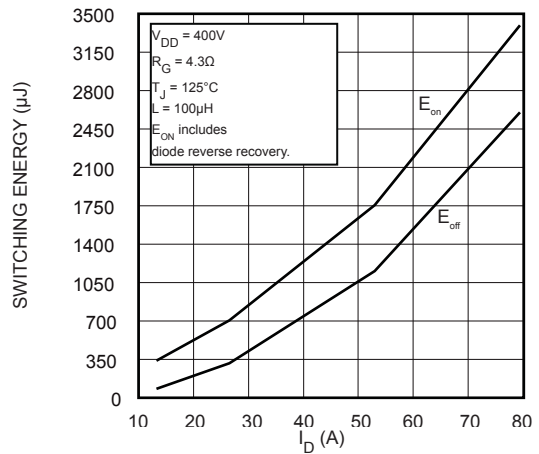

FIGURE 15, Switching Energy vs Current

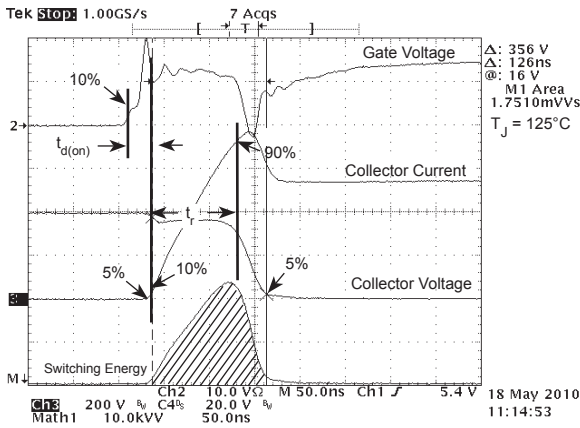

Figure 17, Turn-on Switching Waveforms and Definitions

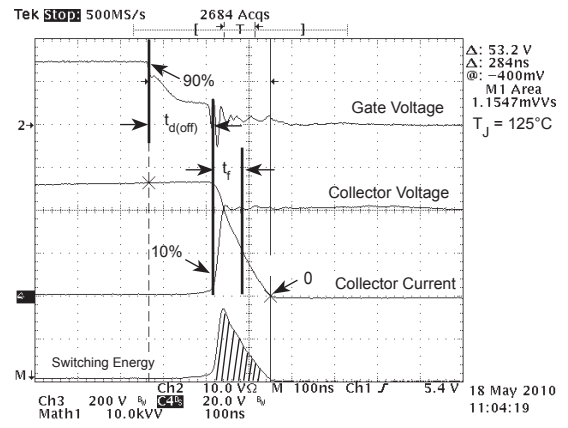

Figure 18, Turn-off Switching Waveforms and Definitions

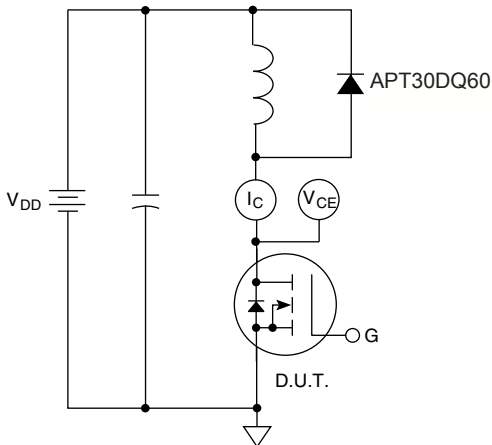
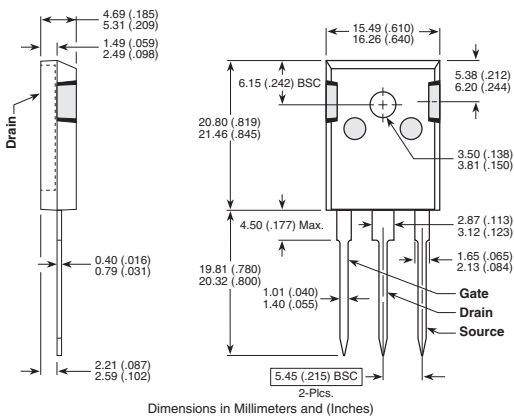
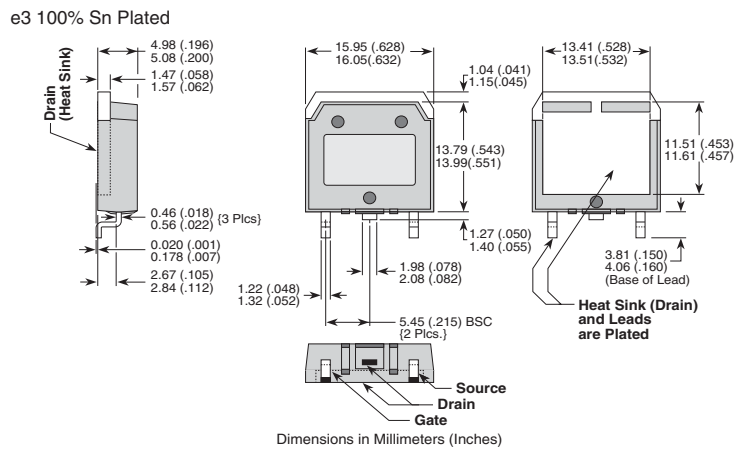

Figure 19, Inductive Switching Test Circuit

TO-247 (B) Package Outline



D³PAK Package Outline



Microsemi's products are covered by one or more of U.S. patents 4,895,810 5,045,903 5,089,434 5,182,234 5,019,522 5,262,336 6,503,786 5,256,583 4,748,103 5,283,202 5,231,474 5,434,095 5,528,058 6,939,743, 7,352,045 5,283,201 5,801,417 5,648,283 7,196,634 6,664,594 7,157,886 6,939,743 7,342,262 and foreign patents. US and Foreign patents pending. All Rights Reserved.

Looking for pricing, stock, or lifecycle information?

Click below to explore more details on WIN SOURCE:

- ⊖ [View APT53N60BC6 on WIN SOURCE](#)
- ⊖ [Microsemi Corporation](#) Information

Optimize Your Supply Chain with WIN SOURCE Solutions

- ✓ Global Sourcing Solution
- ✓ Obsolete Management
- ✓ Cost Control Management
- ✓ Shortage Management
- ✓ Alternative Solution
- ✓ Excess Inventory Management