



Is Now Part of



**ON Semiconductor®**

To learn more about ON Semiconductor, please visit our website at  
[www.onsemi.com](http://www.onsemi.com)

Please note: As part of the Fairchild Semiconductor integration, some of the Fairchild orderable part numbers will need to change in order to meet ON Semiconductor's system requirements. Since the ON Semiconductor product management systems do not have the ability to manage part nomenclature that utilizes an underscore (\_), the underscore (\_) in the Fairchild part numbers will be changed to a dash (-). This document may contain device numbers with an underscore (\_). Please check the ON Semiconductor website to verify the updated device numbers. The most current and up-to-date ordering information can be found at [www.onsemi.com](http://www.onsemi.com). Please email any questions regarding the system integration to [Fairchild\\_questions@onsemi.com](mailto:Fairchild_questions@onsemi.com).

ON Semiconductor and the ON Semiconductor logo are trademarks of Semiconductor Components Industries, LLC dba ON Semiconductor or its subsidiaries in the United States and/or other countries. ON Semiconductor owns the rights to a number of patents, trademarks, copyrights, trade secrets, and other intellectual property. A listing of ON Semiconductor's product/patent coverage may be accessed at [www.onsemi.com/site/pdf/Patent-Marking.pdf](http://www.onsemi.com/site/pdf/Patent-Marking.pdf). ON Semiconductor reserves the right to make changes without further notice to any products herein. ON Semiconductor makes no warranty, representation or guarantee regarding the suitability of its products for any particular purpose, nor does ON Semiconductor assume any liability arising out of the application or use of any product or circuit, and specifically disclaims any and all liability, including without limitation special, consequential or incidental damages. Buyer is responsible for its products and applications using ON Semiconductor products, including compliance with all laws, regulations and safety requirements or standards, regardless of any support or applications information provided by ON Semiconductor. "Typical" parameters which may be provided in ON Semiconductor data sheets and/or specifications can and do vary in different applications and actual performance may vary over time. All operating parameters, including "Typicals" must be validated for each customer application by customer's technical experts. ON Semiconductor does not convey any license under its patent rights nor the rights of others. ON Semiconductor products are not designed, intended, or authorized for use as a critical component in life support systems or any FDA Class 3 medical devices or medical devices with a same or similar classification in a foreign jurisdiction or any devices intended for implantation in the human body. Should Buyer purchase or use ON Semiconductor products for any such unintended or unauthorized application, Buyer shall indemnify and hold ON Semiconductor and its officers, employees, subsidiaries, affiliates, and distributors harmless against all claims, costs, damages, and expenses, and reasonable attorney fees arising out of, directly or indirectly, any claim of personal injury or death associated with such unintended or unauthorized use, even if such claim alleges that ON Semiconductor was negligent regarding the design or manufacture of the part. ON Semiconductor is an Equal Opportunity/Affirmative Action Employer. This literature is subject to all applicable copyright laws and is not for resale in any manner.

# FAN2512, FAN2513

## 150 mA CMOS LDO Regulators with Fast Start Enable

### Features

- Ultra Low Power Consumption
- Enable optimized for CDMA time phases
- 150 mV dropout voltage at 150 mA
- 25  $\mu$ A ground current at 150 mA
- Enable/Shutdown Control
- SOT23-5 package
- Thermal limiting
- 300 mA peak current

### Applications

- Cellular Phones and accessories
- PDAs
- Portable cameras and video recorders
- Laptop, notebook and palmtop computers

### Description

The FAN2512/13 family of micropower low-dropout voltage regulators utilize CMOS technology to offer a new level of cost-effective performance in GSM, TDMA, and CDMA cellular handsets, Laptop and Notebook portable computers, and other portable devices. Features include extremely low power consumption and low shutdown current, low dropout voltage, exceptional loop stability able to accommodate a

wide variety of external capacitors, and the compact SOT23-5 surface-mount package. In addition, the FAN2512/13 family offer the fast power-cycle time required in CDMA handset applications. These products offer significant improvements over older BiCMOS designs and are pin-compatible with many popular devices. The output is thermally protected against overload.

The FAN2512 and FAN2513 devices are distinguished by the assignment of pin 4:

**FAN2512:** pin 4 – ADJ, allowing the user to adjust the output voltage over a wide range using an external voltage divider.

**FAN2512-XX:** pin 4 – BYP, to which a bypass capacitor may be connected for optimal noise performance. Output voltage is fixed, indicated by the suffix XX.

**FAN2513-XX:** pin 4 –  $\overline{\text{ERR}}$ , a flag which indicates that the output voltage has dropped below the specified minimum due to a fault condition.

The standard fixed output voltages available are 2.5V, 2.6V, 2.7V, 2.8V, 2.85V, 3.0V, and 3.3V. Custom output voltage are also available; please contact your local Fairchild Sales Office for information.

### Block Diagrams

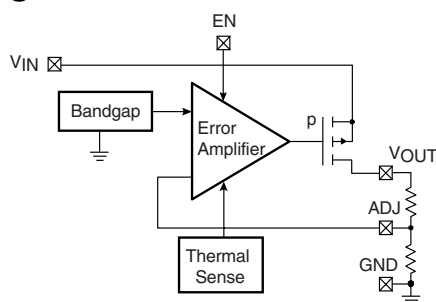

FAN2512

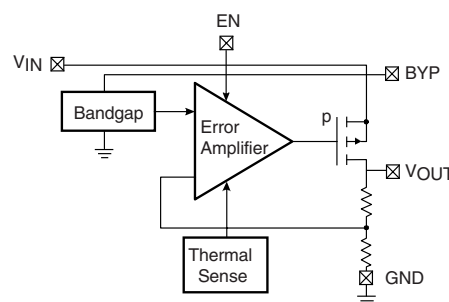

FAN2512-XX

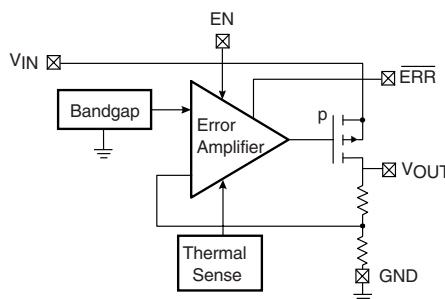

FAN2513-XX

## Pin Assignments

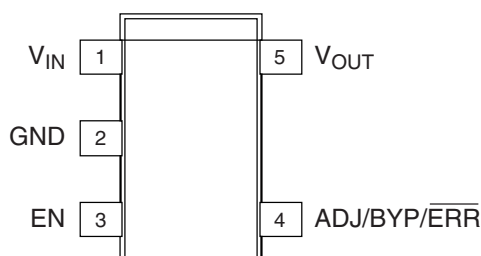

Pin No.	FAN2512	FAN2512-XX	FAN2513-XX
1.	V <sub>IN</sub>	V <sub>IN</sub>	V <sub>IN</sub>
2.	GND	GND	GND
3.	EN	EN	EN
4.	ADJ	BYP	$\overline{\text{ERR}}$
5.	V <sub>OUT</sub>	V <sub>OUT</sub>	V <sub>OUT</sub>

## Pin Descriptions

Pin Name	Pin No.	Type	Pin Function Description
ADJ	4	Input	<b>FAN2512 Adjust.</b> Ratio of potential divider from V <sub>OUT</sub> to ADJ determines output voltage.
BYP	4	Passive	<b>FAN2512-XX Bypass.</b> Connect 470 pF capacitor for noise reduction.
$\overline{\text{ERR}}$	4	Open drain	<b>FAN2513-XX Error.</b> Error flag output. 0: Output voltage < 95% of nominal. 1: Output voltage > 95% of nominal.
EN	3	Digital Input	<b>Enable.</b> 0: Shutdown V <sub>OUT</sub> . 1: Enable V <sub>OUT</sub> .
V <sub>IN</sub>	1	Power in	<b>Voltage Input.</b> Supply voltage input.
V <sub>OUT</sub>	5	Power out	<b>Voltage Output.</b> Regulated output voltage.
GND	2	Power	<b>Ground.</b>

## Functional Description

Designed utilizing CMOS process technology, the FAN2512/13 family of products are carefully optimized for use in compact battery-powered devices, offering a unique combination of low power consumption, extremely low dropout voltages, high tolerance for a variety of output capacitors, and the ability to disable the output to less than 1µA under user control. In the circuit, a difference amplifier controls the current through a series-pass P-Channel MOSFET, comparing the load voltage at the output with an onboard low-drift bandgap reference. The series resistance of the pass P-Channel MOSFET is approximately 1Ω, resulting in an unusually low dropout voltage under load when compared to older bipolar pass-transistor designs.

Protection circuitry is provided onboard for overload conditions. In conditions where the device reaches temperatures exceeding the specified maximums, an onboard circuit shuts down the output, where it remains suspended until it has cooled before re-enabling. The user is also free to shut down the device using the Enable control pin at any time.

Careful design of the output regulator amplifier assures loop stability over a wide range of ESR values in the external output capacitor. A wide range of values and types can be accommodated, allowing the user to select a capacitor meeting his space, cost, and performance requirements, and enjoy reliable operation over temperature, load, and tolerance variations.

An Enable pin, available on all devices, allows the user to shut down the regulator output to conserve power, reducing supply current to less than 1 $\mu$ A. The output can then be re-Enabled within 500 $\mu$ Sec, fulfilling the fast power-cycling needs of CDMA applications. Depending on the model selected, other control and status functions are available at pin 4 to enhance the operation of the device. The adjustable-voltage versions utilize pin 4 to connect to an external voltage divider which feeds back to the regulator error amplifier, thereby setting the voltage as desired. Two other functions are available in the fixed-voltage versions: in noise-sensitive applications, an external Bypass capacitor connection is provided that allows the user to achieve optimal noise performance at the output, while the Error output functions as a diagnostic flag to indicate that the output voltage has dropped more than 5% below the nominal fixed voltage.

## Applications Information

### External Capacitors – Selection

The FAN2512/13 allows the user to utilize a wide variety of capacitors compared to other LDO products. An innovative design approach offers significantly reduced sensitivity to ESR (Effective Series Resistance), which degrades regulator loop stability in older designs. While the improvements featured in the FAN2512/13 family greatly simplify the design task, capacitor quality still must be considered if the designer is to achieve optimal circuit performance. In general, ceramic capacitors offer superior ESR performance, at a lower cost and a smaller case size than tantalums. Those with X7R or Y5V dielectric offer the best temperature coefficient characteristics. The combination of tolerance and variation over temperature in some capacitor types can result in significant variations, resulting in unstable performance over rated conditions.

### Input Capacitor

An input capacitor of 2.2 $\mu$ F (nominal value) or greater, connected between the Input pin and Ground, located in close proximity to the device, will improve transient response and noise rejection. Higher values will offer superior input ripple rejection and transient response. An input capacitor is recommended when the input source, either a battery or a regulated AC voltage, is located far from the device. Any good quality ceramic, tantalum, or metal film capacitor will give acceptable performance, however tantalum capacitors with a surge current rating appropriate to the application must be selected to avoid catastrophic failure.

### Output Capacitor

An output capacitor is required to maintain regulator loop stability. Unlike many other LDO regulators, the FAN2512/13 family of products are nearly insensitive to output capacitor ESR. Stable operation will be achieved with a wide variety of capacitors with ESR values ranging from 10m $\Omega$  to 10 $\Omega$  or

more. Tantalum or aluminum electrolytic, or multilayer ceramic types can all be used. A nominal value of at least 1 $\mu$ F is recommended.

### Bypass Capacitor (FAN2512 Only)

In the fixed-voltage configuration, connecting a capacitor between the bypass pin and ground can significantly reduce noise on the output. Values ranging from 470pF to 10nF can be used, depending on the sensitivity to output noise in the application.

At the high-impedance Bypass pin, care must be taken in the circuit layout to minimize noise pickup, and capacitors must be selected to minimize current loading (leakage). Noise pickup from external sources can be considerable. Leakage currents into the Bypass pin will directly affect regulator accuracy and should be kept as low as possible; thus, high-quality ceramic and film types are recommended for their low leakage characteristics. Cost-sensitive applications not concerned with noise can omit this capacitor.

## Control Functions

### Enable Pin

Applying a voltage of 0.4V or less at the Enable pin will disable the output, reducing the quiescent output current to less than 1 $\mu$ A, while a voltage of 2.0V or greater will enable the device. If this shutdown function is not needed, the pin can simply be connected to the  $V_{IN}$  pin. Allowing this pin to float will cause erratic operation.

### Error Flag (FAN2513 Only)

To indicate conditions such as input voltage dropout (low  $V_{IN}$ ), overheating, or overloading (excessive output current), the  $\overline{ERR}$  pin indicates a fault condition. It is an open-drain output which is HIGH when the voltage at  $V_{OUT}$  is greater than 95% of the nominal rated output voltage and LOW when  $V_{OUT}$  is less than 95% of the rated output voltage, as specified in the error trip level characteristics.

A logic pullup resistor of 100K $\Omega$  is recommended at this output. The pin can be left disconnected if unused.

### Thermal Protection

The FAN2512/13 is designed to supply high peak output currents of up to 1A for brief periods, however this output load will cause the device temperature to increase and exceed maximum ratings due to power dissipation. During output overload conditions, when the die temperature exceeds the shutdown limit temperature of 150 $^{\circ}$ C, onboard thermal protection will disable the output until the temperature drops below this limit, at which point the output is then re-enabled. During a thermal shutdown situation the user may assert the power-down function at the Enable pin, reducing power consumption to the minimum level  $I_{GND}$ .

## Thermal Characteristics

The FAN2512/13 is designed to supply 150mA at the specified output voltage with an operating die (junction) temperature of up to 125°C. Once the power dissipation and thermal resistance is known, the maximum junction temperature of the device can be calculated. While the power dissipation is calculated from known electrical parameters, the thermal resistance is a result of the thermal characteristics of the compact SOT23-5 surface-mount package and the surrounding PC Board copper to which it is mounted.

The power dissipation is equal to the product of the input-to-output voltage differential and the output current plus the ground current multiplied by the input voltage, or:

$$P_D = (V_{IN} - V_{OUT})I_{OUT} + V_{IN}I_{GND}$$

The ground pin current  $I_{GND}$  can be found in the charts provided in the Electrical Characteristics section.

The relationship describing the thermal behavior of the package is:

$$P_{D(max)} = \left\{ \frac{T_{J(max)} - T_A}{\theta_{JA}} \right\}$$

where  $T_{J(max)}$  is the maximum allowable junction temperature of the die, which is 125°C, and  $T_A$  is the ambient operating temperature.  $\theta_{JA}$  is dependent on the surrounding PC board layout and can be empirically obtained. While the  $\theta_{JC}$  (junction-to-case) of the SOT23-5 package is specified at 130°C/W, the  $\theta_{JA}$  of the minimum PWB footprint will be at least 235°C/W. This can be improved upon by providing a heat sink of surrounding copper ground on the PWB.

Depending on the size of the copper area, the resulting  $\theta_{JA}$  can range from approximately 180°C/W for one square inch to nearly 130°C/W for 4 square inches. The addition of backside copper with through-holes, stiffeners, and other enhancements can also aid in reducing this value. The heat contributed by the dissipation of other devices located nearby must be included in design considerations.

Once the limiting parameters in these two relationships have been determined, the design can be modified to ensure that the device remains within specified operating conditions. If overload conditions are not considered, it is possible for the

device to enter a thermal cycling loop, in which the circuit enters a shutdown condition, cools, re-enables, and then again overheats and shuts down repeatedly due to an unmanaged fault condition.

## Operation of Adjustable Version

The adjustable version of the FAN2512/13 includes an input pin ADJ which allows the user to select an output voltage ranging from 1.32V to near  $V_{IN}$ , using an external resistor divider. The voltage  $V_{ADJ}$  presented to the ADJ pin is fed to the onboard error amplifier which adjusts the output voltage until  $V_{ADJ}$  is equal to the onboard bandgap reference voltage of 1.32V(typ). The equation is:

$$V_{OUT} = 1.32V \times \left[ 1 + \frac{R_{upper}}{R_{lower}} \right]$$

The total value of the resistor chain should not exceed 250K $\Omega$  total to keep the error amplifier biased during no-load conditions. Programming output voltages very near  $V_{IN}$  need to allow for the magnitude and variation of the dropout voltage  $V_{DO}$  over load, supply, and temperature variations. Note that the low-leakage FET input to the CMOS Error Amplifier induces no bias current error to the calculation.

## General PWB Layout Considerations

To achieve the full performance of the device, careful circuit layout and grounding technique must be observed. Establishing a small local ground, to which the GND pin, the output and bypass capacitors are connected, is recommended, while the input capacitor should be grounded to the main ground plane. The quiet local ground is then routed back to the main ground plane using feedthrough vias. In general, the high-frequency compensation components (input, bypass, and output capacitors) should be located as close to the device as possible. The proximity of the output capacitor is especially important to achieve optimal noise compensation from the onboard error amplifier, especially during high load conditions. A large copper area in the local ground will provide the heat sinking discussed above when high power dissipation significantly increases the temperature of the device.

Component-side copper provides significantly better thermal performance for this surface-mount device, compared to that obtained when using only copper planes on the underside.

## Absolute Maximum Ratings (beyond which the device may be damaged)<sup>1</sup>

Parameter	Min	Typ	Max	Unit
<b>Power Supply Voltages</b>				
V <sub>IN</sub> (Measured to GND)	0		7	V
<b>Enable Input (EN)</b>				
Applied voltage (Measured to GND) <sup>2</sup>	0		7	V
<b>ERR Output</b>				
Applied voltage (Measured to GND) <sup>2</sup>	0		7	V
<b>Power</b>				
Dissipation <sup>3</sup>	Internally limited			
<b>Temperature</b>				
Junction	-65		150	°C
Lead Soldering (5 seconds)			260	°C
Storage	-65		150	°C
Electrostatic Discharge <sup>4</sup>	4			kV

### Notes:

- Functional operation under any of these conditions is NOT implied. Performance and reliability are guaranteed only if Operating Conditions are not exceeded.
- Applied voltage must be current limited to specified range.
- Based upon thermally limited junction temperature:

$$P_D = \frac{T_{J(max)} - T_A}{\theta_{JA}}$$

- Human Body Model is 4kV minimum using Mil Std. 883E, method 3015.7. Machine Model is 400V minimum using JEDEC method A115-A.

## Recommended Operating Conditions

Parameter	Min	Nom	Max	Units
V <sub>IN</sub>   Input Voltage Range	2.7		6.5	V
V <sub>EN</sub>   Enable Input Voltage	0		V <sub>IN</sub>	V
V <sub>ERR</sub>   ERR Flag Voltage			V <sub>IN</sub>	V
T <sub>J</sub>   Junction Temperature	-40		+125	°C
θ <sub>JA</sub>   Thermal resistance		220		°C/W
θ <sub>JC</sub>   Thermal resistance		130		°C/W

**Electrical Characteristics** (Notes 1, 2)

Symbol	Parameter	Conditions	Min.	Typ.	Max.	Units
<b>Regulator</b>						
V <sub>DO</sub>	Drop Out Voltage	I <sub>OUT</sub> = 100 μA		2.5	4	mV
		I <sub>OUT</sub> = 50 mA		50	75	mV
		I <sub>OUT</sub> = 100 mA		100	140	mV
		I <sub>OUT</sub> = 150 mA		150	180	mV
ΔV <sub>O</sub>	Output Voltage Accuracy		<b>-2</b>		<b>2</b>	%
V <sub>REF</sub>	Reference Voltage Accuracy, Adjustable Mode		<b>1.24</b>	1.32	<b>1.40</b>	V
ΔV <sub>O</sub> <sup>3</sup>	Output Voltage Accuracy, Adjustable Mode		-6		6	%
I <sub>GND</sub>	Ground Pin Current	I <sub>OUT</sub> = 150 mA			50	μA
<b>Protection</b>						
	Current Limit	Thermally Protected				
I <sub>GSD</sub>	Shut-Down Current	EN = 0V			1	μA
T <sub>SH</sub>	Thermal Protection Shutdown Temperature		150			°C
E <sub>TL</sub>	ERR Trip Level	FAN2513 only	90	95	99	%
<b>Enable Input</b>						
V <sub>IL</sub>	Logic Low Voltage			1.2	<b>0.4</b>	V
V <sub>IH</sub>	Logic High Voltage		<b>2.0</b>	1.4		V
I <sub>IH</sub>	Input Current High				1	μA
I <sub>I</sub>	Input Current Low				1	μA

**Switching Characteristics** (Notes 1, 2)

Parameter	Conditions	Min.	Typ.	Max.	Unit
<b>Enable Input<sup>4</sup></b>					
Response time				500	μsec
<b>Error Flag (FAN2513-XX)</b>					
Response time				3	msec

**Performance Characteristics** (Notes 1, 2)

Symbol	Parameter	Conditions	Min.	Typ.	Max.	Units
ΔV <sub>OUT</sub> /ΔV <sub>IN</sub>	Line regulation	V <sub>IN</sub> = (V <sub>OUT</sub> + 1) to 6.5V		0.3		%/V
ΔV <sub>OUT</sub> /V <sub>OUT</sub>	Load regulation	I <sub>OUT</sub> = 0.1 to 150mA		1.0	2.0	%
e <sub>N</sub>	Output noise	10Hz–1KHz, C <sub>OUT</sub> = 10μF, C <sub>BYP</sub> = 0.01μF  >10KHz, C <sub>OUT</sub> = 10μF, C <sub>BYP</sub> = 0.01μF		<7  <0.01		μV/√Hz
PSRR	Power Supply Rejection	120 Hz, C <sub>OUT</sub> = 10μF, C <sub>BYP</sub> = 0.01μF		43		dB

**Notes:**

1. Unless otherwise stated, T<sub>A</sub> = 25°C, V<sub>IN</sub> = V<sub>OUT</sub> + 1V, I<sub>OUT</sub> = 100μA, V<sub>IH</sub> > 2.0 V.
2. Bold values indicate -40 ≤ T<sub>J</sub> ≤ 125°C.
3. The adjustable version, has a bandgap voltage range of 1.24V to 1.40V with a nominal value of 1.32V.
4. When using repeated cycling.

# Typical Performance Characteristics

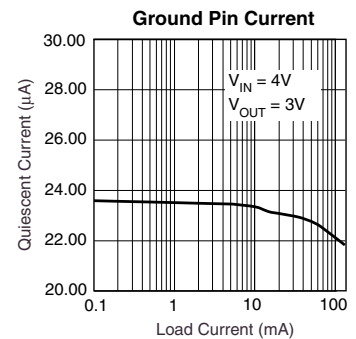
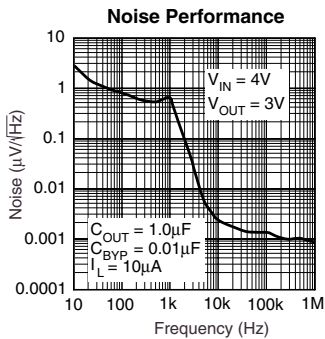
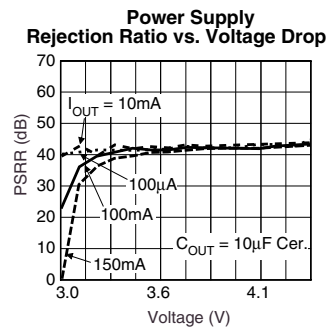
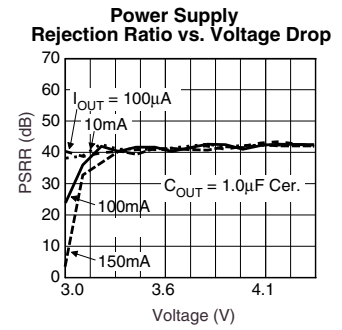
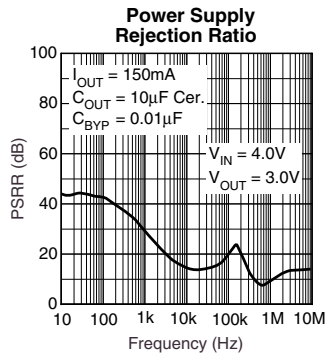
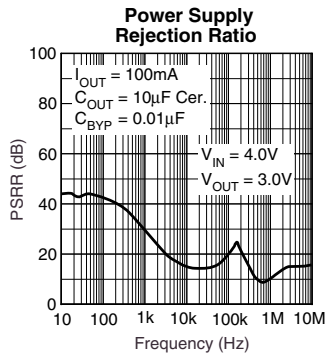
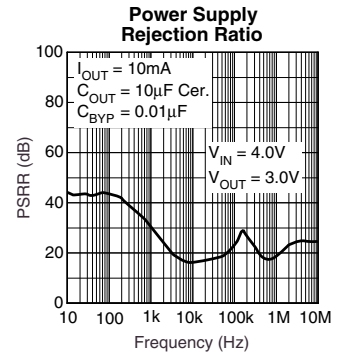
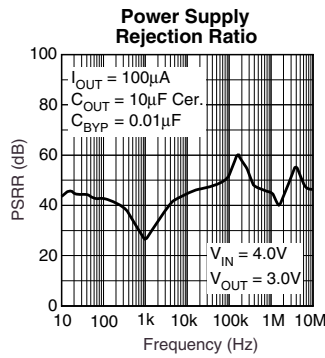
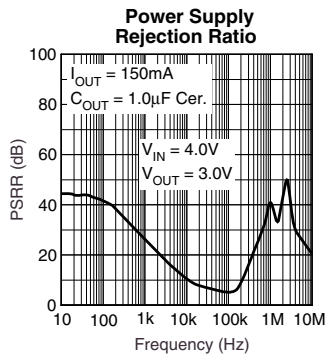
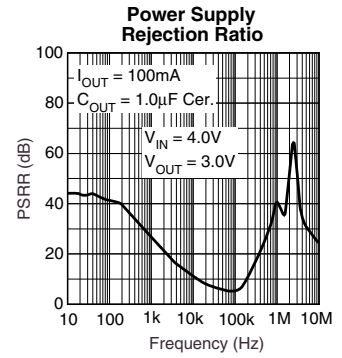
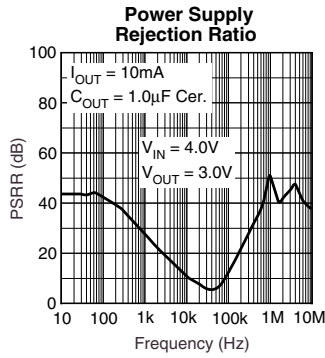
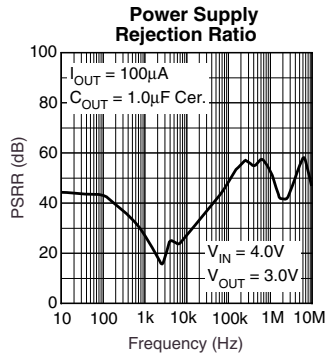

### Typical Performance Characteristics (continued)

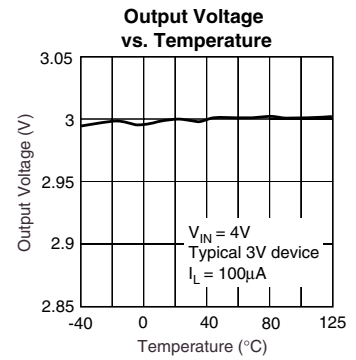
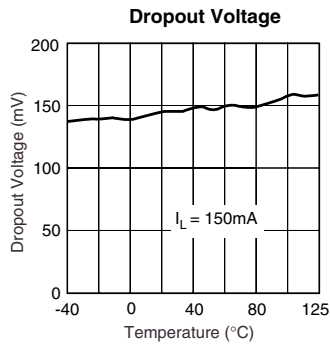
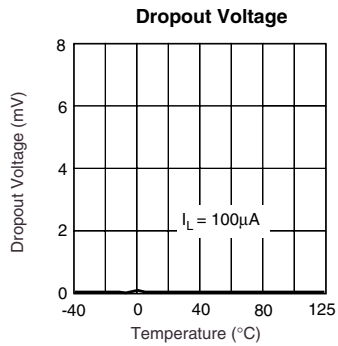
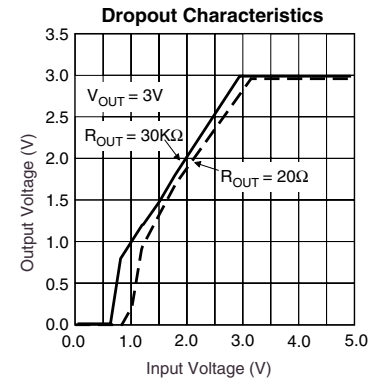
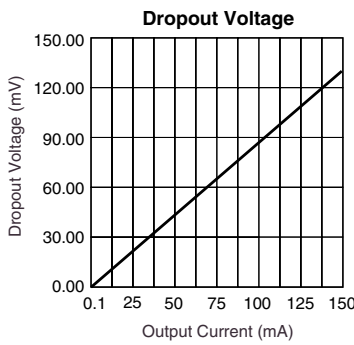
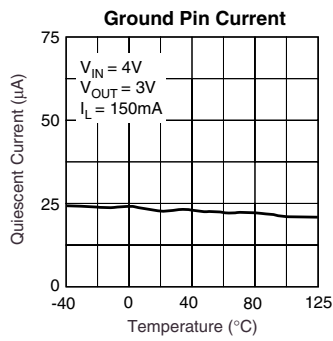
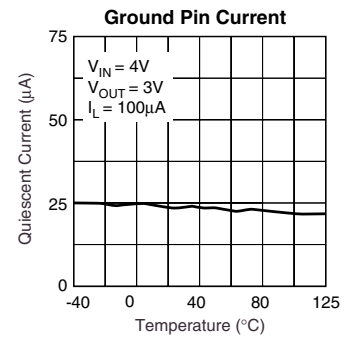
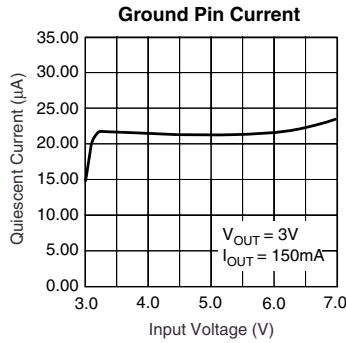
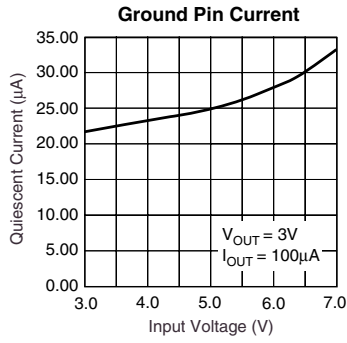

### Functional Characteristics

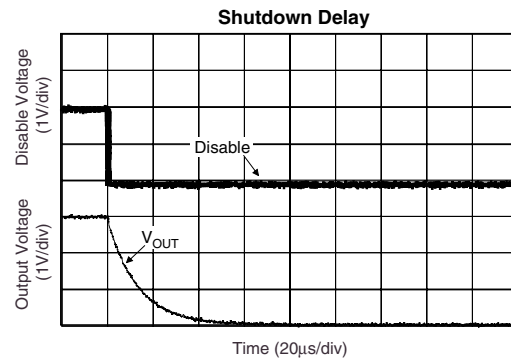
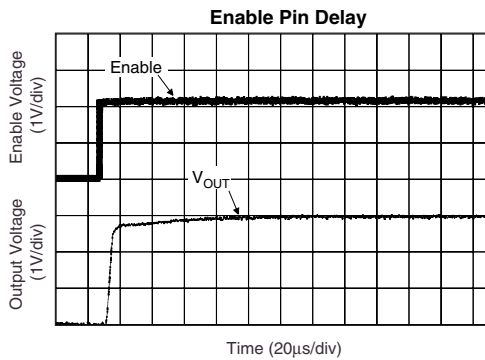

# Mechanical Dimensions

## 5-Lead SOT-23-5 (S) Package

Symbol	Inches		Millimeters		Notes
	Min.	Max.	Min.	Max.	
A	.035	.057	.90	1.45	
A1	.000	.006	.00	.15	
B	.008	.020	.20	.50	
c	.003	.010	.08	.25	
D	.106	.122	2.70	3.10	
E	.059	.071	1.50	1.80	
e	.037 BSC		.95 BSC		
e1	.075 BSC		1.90 BSC		
H	.087	.126	2.20	3.20	
L	.004	.024	.10	.60	
$\alpha$	0°	10°	0°	10°	

**Notes:**

1. Package outline exclusive of mold flash & metal burr.
2. Package outline exclusive of solder plating.
3. EIAJ Ref Number SC-74A.

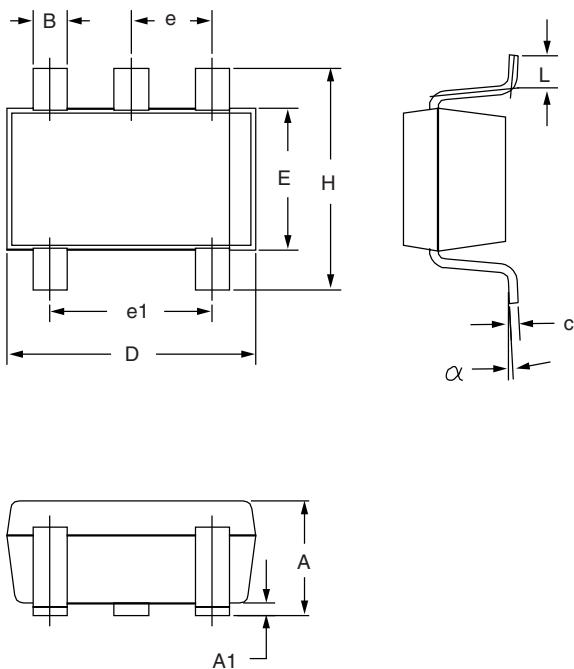



ON Semiconductor and  are trademarks of Semiconductor Components Industries, LLC dba ON Semiconductor or its subsidiaries in the United States and/or other countries. ON Semiconductor owns the rights to a number of patents, trademarks, copyrights, trade secrets, and other intellectual property. A listing of ON Semiconductor's product/patent coverage may be accessed at [www.onsemi.com/site/pdf/Patent-Marking.pdf](http://www.onsemi.com/site/pdf/Patent-Marking.pdf). ON Semiconductor reserves the right to make changes without further notice to any products herein. ON Semiconductor makes no warranty, representation or guarantee regarding the suitability of its products for any particular purpose, nor does ON Semiconductor assume any liability arising out of the application or use of any product or circuit, and specifically disclaims any and all liability, including without limitation special, consequential or incidental damages. Buyer is responsible for its products and applications using ON Semiconductor products, including compliance with all laws, regulations and safety requirements or standards, regardless of any support or applications information provided by ON Semiconductor. "Typical" parameters which may be provided in ON Semiconductor data sheets and/or specifications can and do vary in different applications and actual performance may vary over time. All operating parameters, including "Typicals" must be validated for each customer application by customer's technical experts. ON Semiconductor does not convey any license under its patent rights nor the rights of others. ON Semiconductor products are not designed, intended, or authorized for use as a critical component in life support systems or any FDA Class 3 medical devices or medical devices with a same or similar classification in a foreign jurisdiction or any devices intended for implantation in the human body. Should Buyer purchase or use ON Semiconductor products for any such unintended or unauthorized application, Buyer shall indemnify and hold ON Semiconductor and its officers, employees, subsidiaries, affiliates, and distributors harmless against all claims, costs, damages, and expenses, and reasonable attorney fees arising out of, directly or indirectly, any claim of personal injury or death associated with such unintended or unauthorized use, even if such claim alleges that ON Semiconductor was negligent regarding the design or manufacture of the part. ON Semiconductor is an Equal Opportunity/Affirmative Action Employer. This literature is subject to all applicable copyright laws and is not for resale in any manner.

## PUBLICATION ORDERING INFORMATION

### LITERATURE FULFILLMENT:

Literature Distribution Center for ON Semiconductor  
19521 E. 32nd Pkwy, Aurora, Colorado 80011 USA  
**Phone:** 303-675-2175 or 800-344-3860 Toll Free USA/Canada  
**Fax:** 303-675-2176 or 800-344-3867 Toll Free USA/Canada  
**Email:** [orderlit@onsemi.com](mailto:orderlit@onsemi.com)

**N. American Technical Support:** 800-282-9855 Toll Free  
USA/Canada  
**Europe, Middle East and Africa Technical Support:**  
Phone: 421 33 790 2910  
**Japan Customer Focus Center**  
Phone: 81-3-5817-1050

**ON Semiconductor Website:** [www.onsemi.com](http://www.onsemi.com)  
**Order Literature:** <http://www.onsemi.com/orderlit>  
For additional information, please contact your local  
Sales Representative

## Looking for pricing, stock, or lifecycle information?

Click below to explore more details on WIN SOURCE:

-  [View FAN2513S285X on WIN SOURCE](#)
-  [Fairchild/ON Semiconductor Information](#)

## Optimize Your Supply Chain with WIN SOURCE Solutions

-  Global Sourcing Solution
-  Obsolete Management
-  Cost Control Management
-  Shortage Management
-  Alternative Solution
-  Excess Inventory Management