

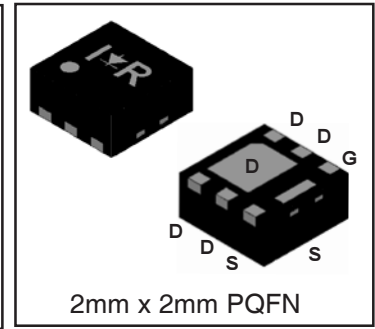

**THE DATASHEET OF  
IRFHS9301TR2PBF**

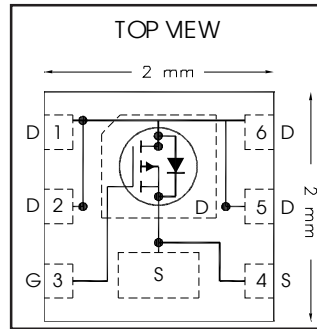

$V_{DS}$	<b>-30</b>	<b>V</b>
$V_{GS\ max}$	<b>±20</b>	<b>V</b>
$R_{DS(on)\ max}$ (@ $V_{GS} = -10V$ )	<b>37</b>	<b>mΩ</b>
$Q_g$ (typical)	<b>13</b>	<b>nC</b>
$I_D$ (@ $T_C = 25^\circ C$ )	<b>-8.5</b> ②	<b>A</b>



### Applications

- Charge and Discharge Switch for Battery Application
- System/load switch

### Features and Benefits

#### Features

Low $R_{DS(on)}$ ( $\leq 37m\Omega$ )
Low Thermal Resistance to PCB ( $\leq 13^\circ C/W$ )
Low Profile ( $\leq 1.0\ mm$ )
Compatible with Existing Surface Mount Techniques
RoHS Compliant Containing no Lead, no Bromide and no Halogen
MSL1, Industrial Qualification

results in

#### Benefits

Lower Conduction Losses
Enable better thermal dissipation
Increased Power Density
Easier Manufacturing
Environmentally Friendlier
Increased Reliability

Orderable part number	Package Type	Standard Pack		Note
		Form	Quantity	
IRFHS9301TRPBF	PQFN 2mm x 2mm	Tape and Reel	4000	
IRFHS9301TR2PBF	PQFN 2mm x 2mm	Tape and Reel	400	EOL notice # 259

### Absolute Maximum Ratings

	Parameter	Max.	Units
$V_{DS}$	Drain-to-Source Voltage	-30	V
$V_{GS}$	Gate-to-Source Voltage	± 20	
$I_D @ T_A = 25^\circ C$	Continuous Drain Current, $V_{GS} @ -10V$	-6.0	A
$I_D @ T_A = 70^\circ C$	Continuous Drain Current, $V_{GS} @ -10V$	-4.8	
$I_D @ T_C = 25^\circ C$	Continuous Drain Current, $V_{GS} @ -10V$	-13②	
$I_D @ T_C = 70^\circ C$	Continuous Drain Current, $V_{GS} @ -10V$	-10②	
$I_D @ T_C = 25^\circ C$	Continuous Drain Current, $V_{GS} @ 10V$ (Package Limited)	-8.5②	
$I_{DM}$	Pulsed Drain Current ①	-52	
$P_D @ T_A = 25^\circ C$	Power Dissipation ④	2.1	W
$P_D @ T_A = 70^\circ C$	Power Dissipation ④	1.3	
	Linear Derating Factor	0.02	W/°C
$T_J$	Operating Junction and	-55 to + 150	°C
$T_{STG}$	Storage Temperature Range		

Notes ① through ⑤ are on page 2

**Static @ T<sub>J</sub> = 25°C (unless otherwise specified)**

	Parameter	Min.	Typ.	Max.	Units	Conditions
BV <sub>DSS</sub>	Drain-to-Source Breakdown Voltage	-30	—	—	V	V <sub>GS</sub> = 0V, I <sub>D</sub> = -250μA
ΔBV <sub>DSS</sub> /ΔT <sub>J</sub>	Breakdown Voltage Temp. Coefficient	—	0.02	—	V/°C	Reference to 25°C, I <sub>D</sub> = -1mA
R <sub>DS(on)</sub>	Static Drain-to-Source On-Resistance	—	30	37	mΩ	V <sub>GS</sub> = -10V, I <sub>D</sub> = -7.8A ③
		—	52	65		V <sub>GS</sub> = -4.5V, I <sub>D</sub> = -6.2A ③
V <sub>GS(th)</sub>	Gate Threshold Voltage	-1.3	-1.8	-2.4	V	V <sub>DS</sub> = V <sub>GS</sub> , I <sub>D</sub> = -25μA
ΔV <sub>GS(th)</sub>	Gate Threshold Voltage Coefficient	—	-4.8	—	mV/°C	
I <sub>DSS</sub>	Drain-to-Source Leakage Current	—	—	-1.0	μA	V <sub>DS</sub> = -24V, V <sub>GS</sub> = 0V
		—	—	-150		V <sub>DS</sub> = -24V, V <sub>GS</sub> = 0V, T <sub>J</sub> = 125°C
I <sub>GSS</sub>	Gate-to-Source Forward Leakage	—	—	-100	nA	V <sub>GS</sub> = -20V
	Gate-to-Source Reverse Leakage	—	—	100		V <sub>GS</sub> = 20V
g <sub>fs</sub>	Forward Transconductance	9.3	—	—	S	V <sub>DS</sub> = -10V, I <sub>D</sub> = -7.8A
Q <sub>g</sub>	Total Gate Charge	—	6.9	—	nC	V <sub>DS</sub> = -15V, V <sub>GS</sub> = -4.5V, I <sub>D</sub> = -7.8A
Q <sub>g</sub>	Total Gate Charge	—	13	—	nC	V <sub>GS</sub> = -10V
Q <sub>gs</sub>	Gate-to-Source Charge	—	2.1	—		V <sub>DS</sub> = -15V
Q <sub>gd</sub>	Gate-to-Drain Charge	—	3.9	—		I <sub>D</sub> = -7.8A
R <sub>G</sub>	Gate Resistance	—	17	—	Ω	
t <sub>d(on)</sub>	Turn-On Delay Time	—	12	—	ns	V <sub>DD</sub> = -15V, V <sub>GS</sub> = -4.5V ③
t <sub>r</sub>	Rise Time	—	80	—		I <sub>D</sub> = -7.8A
t <sub>d(off)</sub>	Turn-Off Delay Time	—	13	—		R <sub>G</sub> = 2.0Ω
t <sub>f</sub>	Fall Time	—	25	—		See Figs. 19a & 19b
C <sub>iss</sub>	Input Capacitance	—	580	—	pF	V <sub>GS</sub> = 0V
C <sub>oss</sub>	Output Capacitance	—	125	—		V <sub>DS</sub> = -25V
C <sub>rss</sub>	Reverse Transfer Capacitance	—	79	—		f = 1.0KHz

**Diode Characteristics**

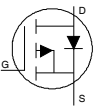
	Parameter	Min.	Typ.	Max.	Units	Conditions
I <sub>S</sub>	Continuous Source Current (Body Diode)	—	—	-8.5②	A	MOSFET symbol showing the integral reverse p-n junction diode. 
I <sub>SM</sub>	Pulsed Source Current (Body Diode) ①	—	—	-52		
V <sub>SD</sub>	Diode Forward Voltage	—	—	-1.2	V	T <sub>J</sub> = 25°C, I <sub>S</sub> = -7.8A, V <sub>GS</sub> = 0V ③
t <sub>rr</sub>	Reverse Recovery Time	—	30	45	ns	T <sub>J</sub> = 25°C, I <sub>F</sub> = -7.8A, V <sub>DD</sub> = -15V
Q <sub>rr</sub>	Reverse Recovery Charge	—	110	170	nC	di/dt = 280/μs ③

**Thermal Resistance**

	Parameter	Typ.	Max.	Units
R <sub>θJC</sub> (Bottom)	Junction-to-Case ⑤	—	13	°C/W
R <sub>θJC</sub> (Top)	Junction-to-Case ⑤	—	90	
R <sub>θJA</sub>	Junction-to-Ambient ④	—	60	
R <sub>θJA</sub>	Junction-to-Ambient (t<10s) ④	—	42	

**Notes:**

- ① Repetitive rating; pulse width limited by max. junction temperature.
- ② Current limited by package.
- ③ Pulse width ≤ 400μs; duty cycle ≤ 2%.
- ④ When mounted on 1 inch square copper board.
- ⑤ R<sub>θ</sub> is measured at T<sub>J</sub> of approximately 90°C.

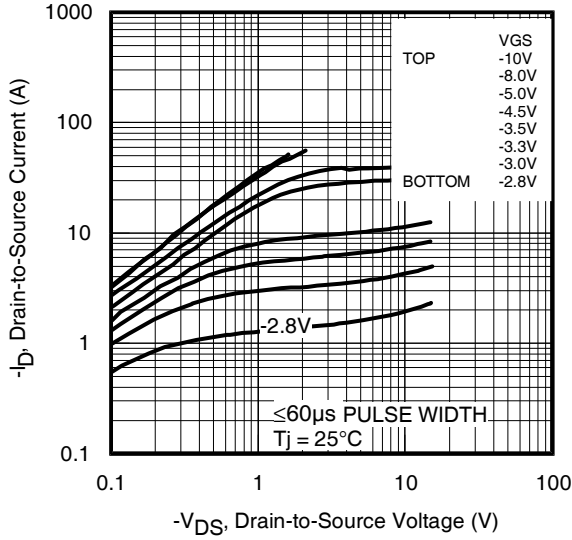
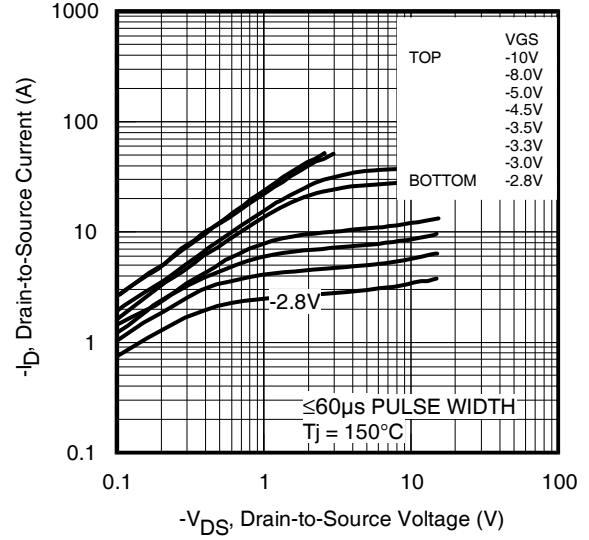
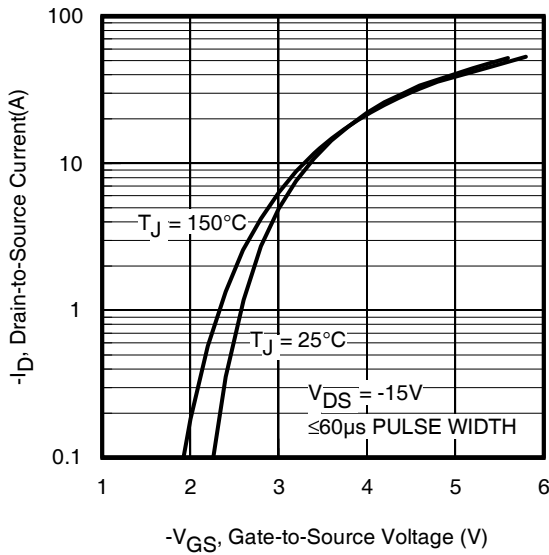
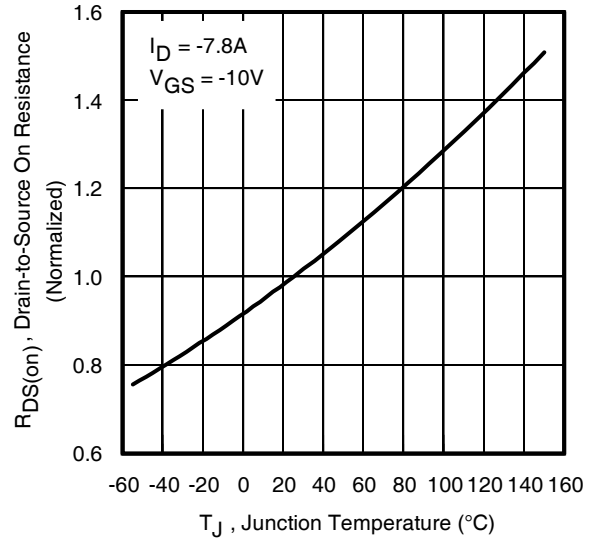
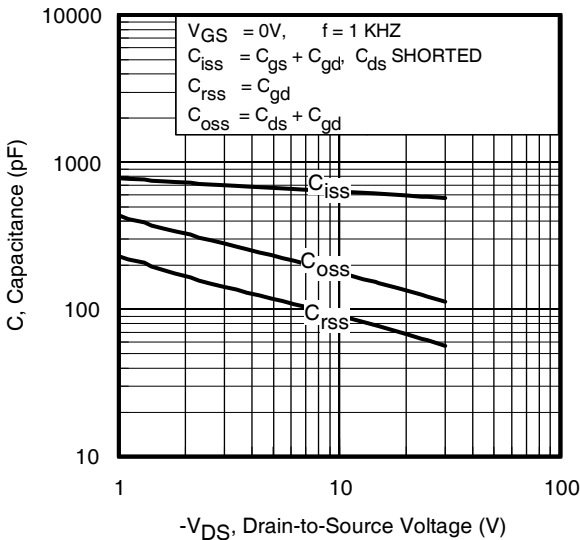
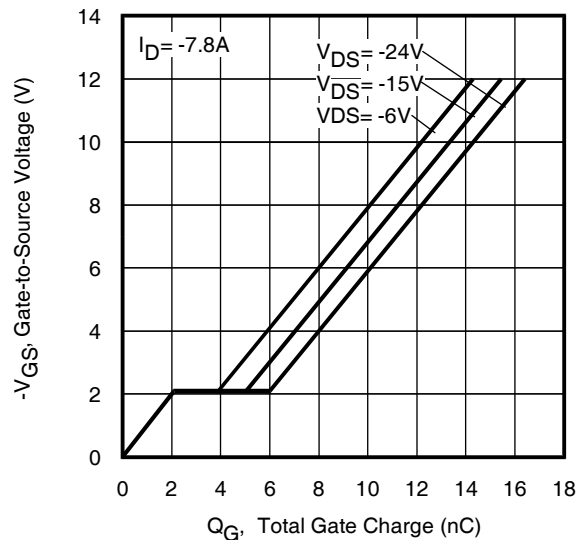
**Fig 1. Typical Output Characteristics**

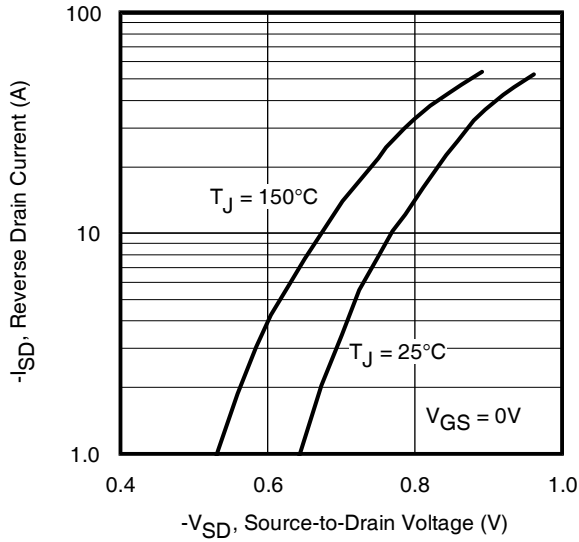
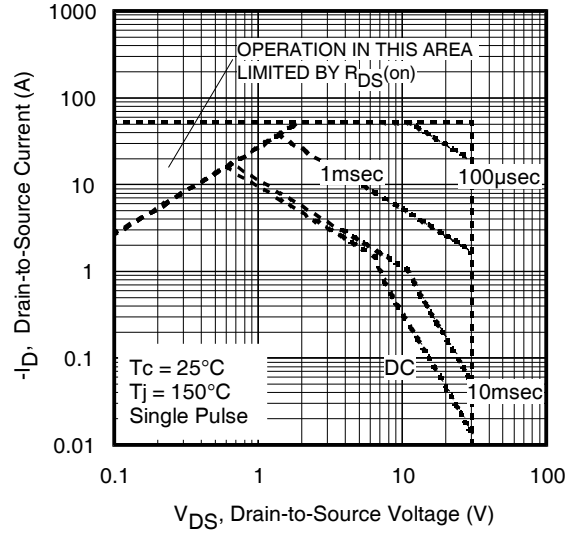
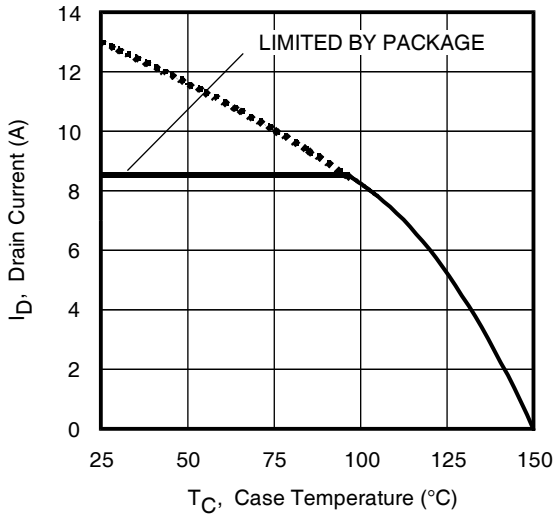
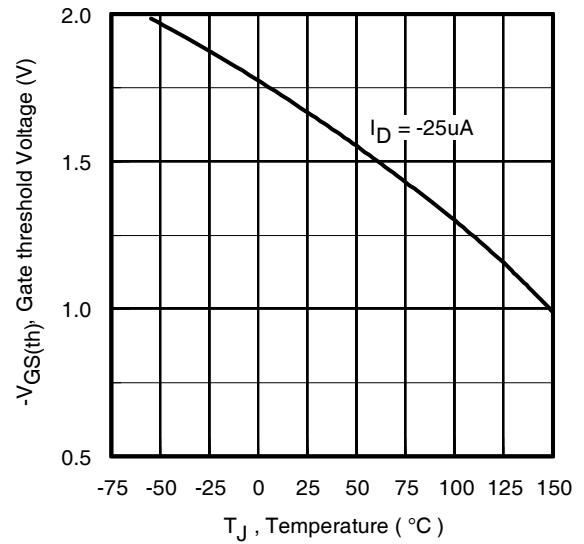
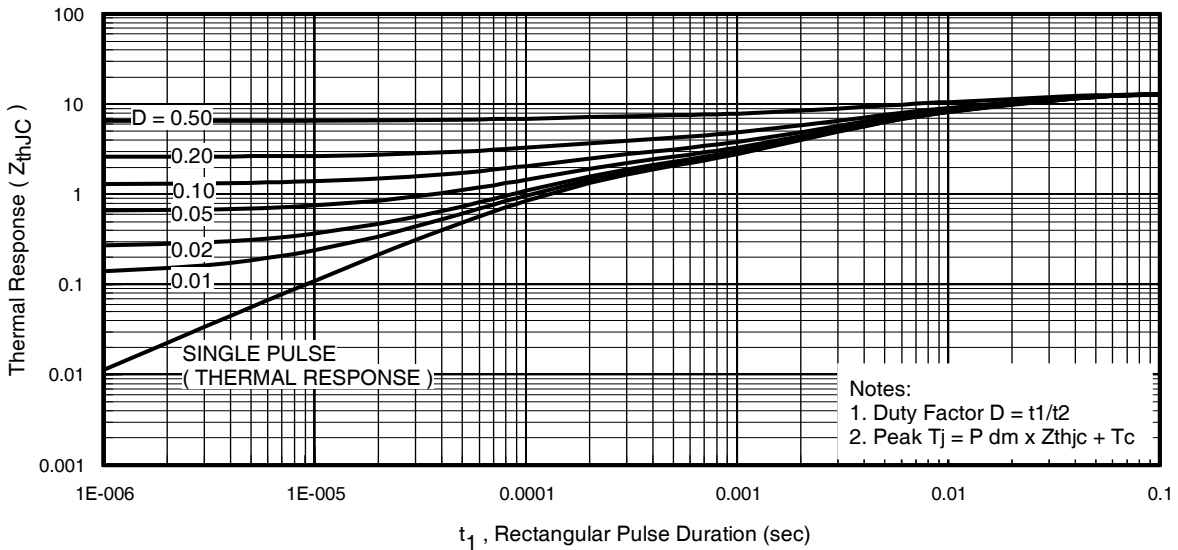
**Fig 2. Typical Output Characteristics**

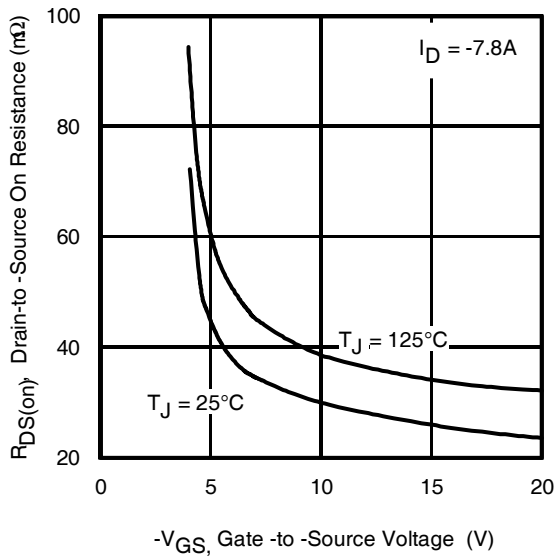
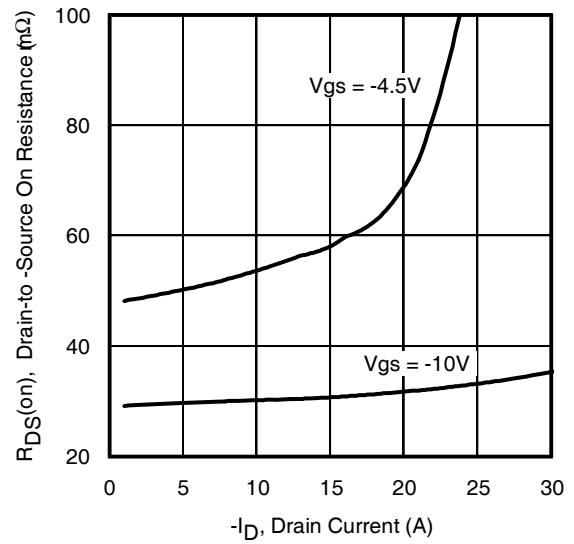
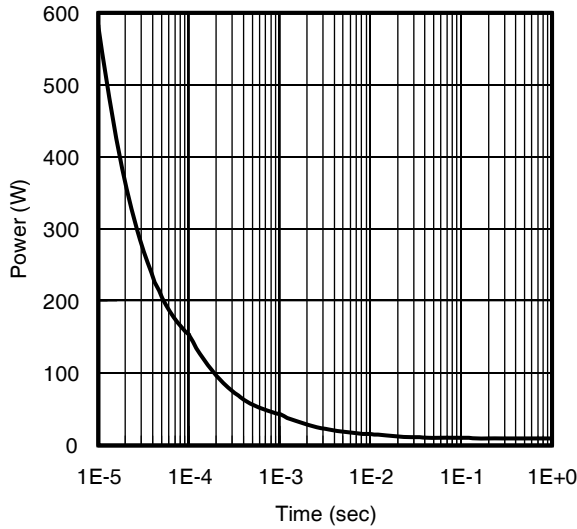
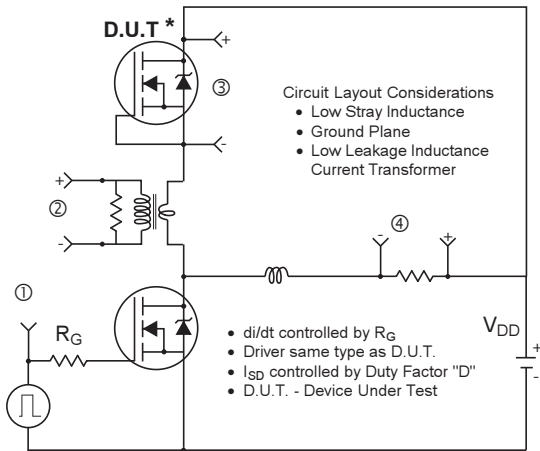
**Fig 3. Typical Transfer Characteristics**

**Fig 4. Normalized On-Resistance vs. Temperature**

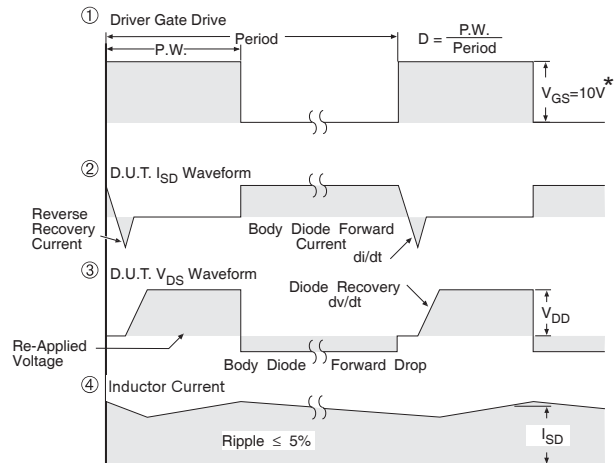
**Fig 5. Typical Capacitance vs. Drain-to-Source Voltage**

**Fig 6. Typical Gate Charge vs. Gate-to-Source Voltage**

**Fig 7.** Typical Source-Drain Diode Forward Voltage

**Fig 8.** Maximum Safe Operating Area

**Fig 9.** Maximum Drain Current vs. Case Temperature

**Fig 10.** Threshold Voltage vs. Temperature

**Fig 11.** Maximum Effective Transient Thermal Impedance, Junction-to-Case

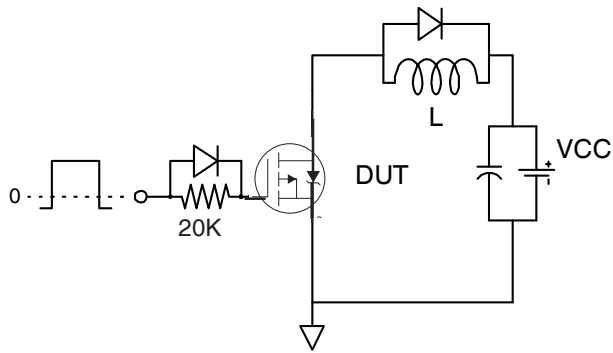
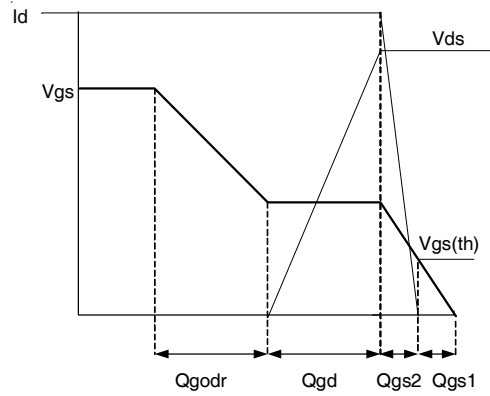
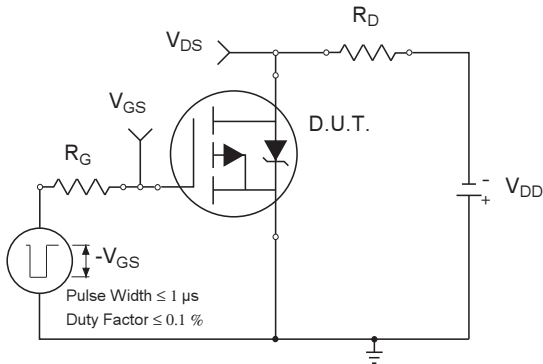
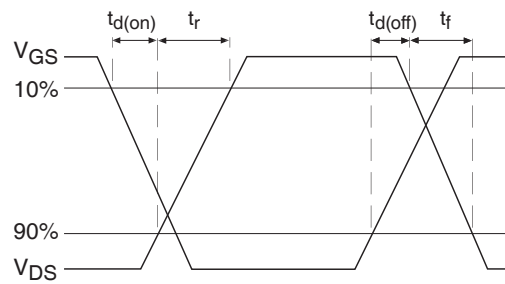

**Fig 12. On-Resistance vs. Gate Voltage**

**Fig 13. Typical On-Resistance vs. Drain Current**

**Fig 14. Typical Power vs. Time**

\* Reverse Polarity of D.U.T for P-Channel



\*  $V_{GS} = 5V$  for Logic Level Devices

**Fig 15. Diode Reverse Recovery Test Circuit for P-Channel HEXFET® Power MOSFETs**

**Fig 16a. Gate Charge Test Circuit**

**Fig 16b. Gate Charge Waveform**

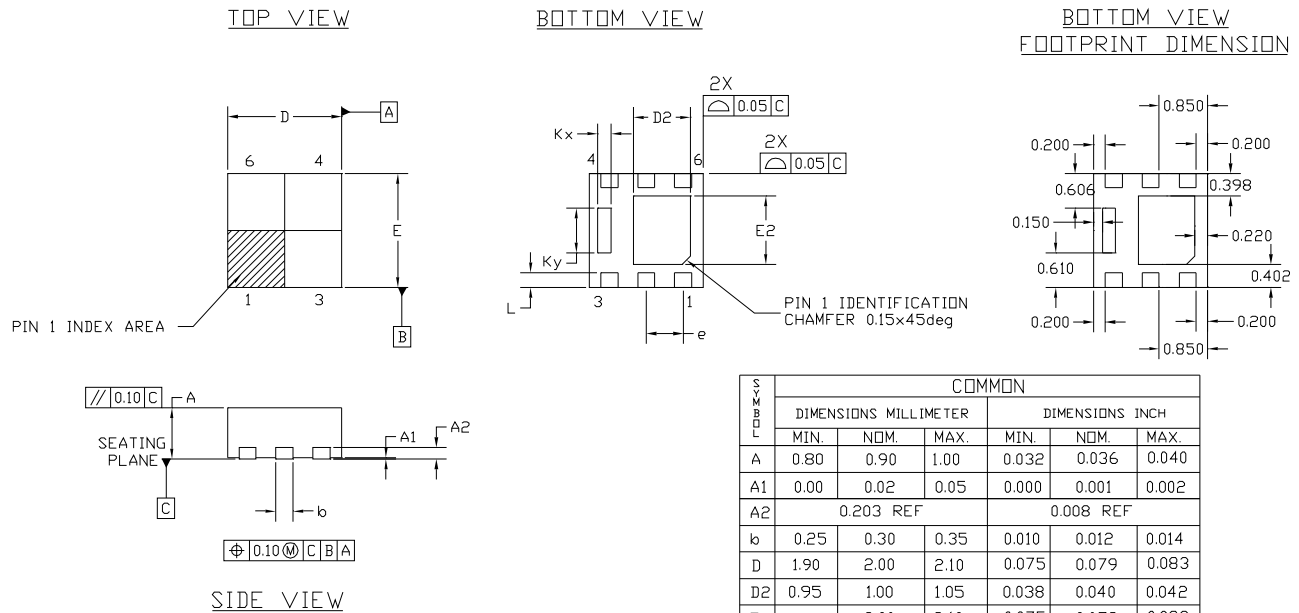
**Fig 17a. Switching Time Test Circuit**

**Fig 17b. Switching Time Waveforms**

## PQFN Package Details



NOTES :

1. DIMENSION AND TOLERANCING CONFORM TO ASME Y14.5M-1994.
2. CONTROLLING DIMENSIONS : MILLIMETER
3. DIMENSION *b* APPLIES TO METALLIZED TERMINAL AND IS MEASURED BETWEEN 0.15 AND 0.30 mm. FROM TERMINAL TIP.

## PQFN Part Marking

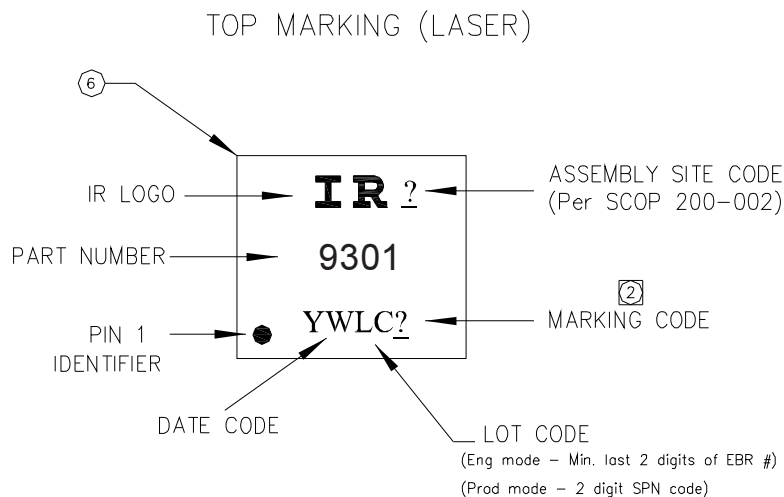

Note: For the most current drawing please refer to IR website at: <http://www.irf.com/package/>

# PQFN Tape and Reel

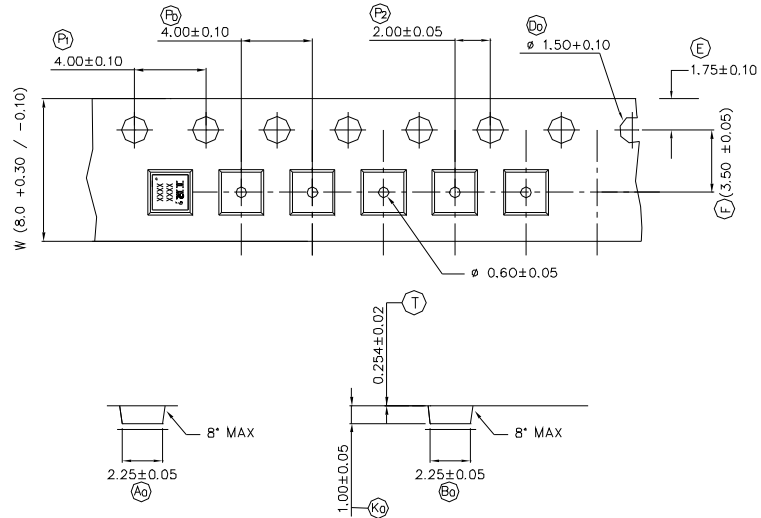

NOTE: The Surface Resistivity is  $10^4 - 10^8$  OHM/SQ

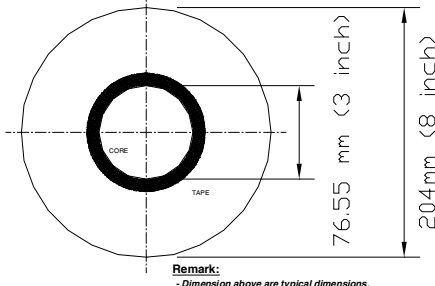
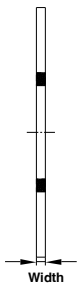

**Remark:**  
 - Dimension above are typical dimensions.  
 - Cover tape thickness is 0.048mm +/- 0.005mm.  
 - Surface resistivity  $10E5 < R_s < 10E9$ .

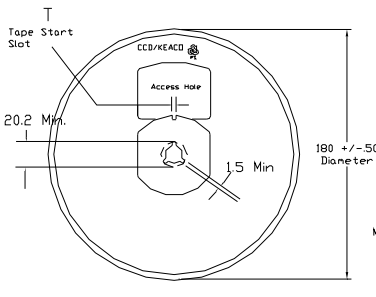

FRONT VIEW

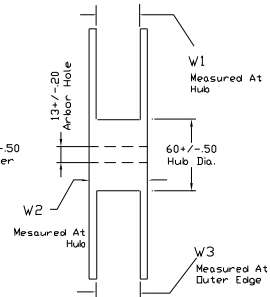

SIDE VIEW

COVER TAPE (WIDTH)	TOLERANCE
5.4 mm	+/- 0.1 mm
9.5 mm	+/- 0.1 mm

TAPE WIDTH	T	W1	W2	W3	PART NO
8 MM	3 ± 0.50	84 <sup>+1.5</sup> <sub>-3.0</sub>	14.4 Max	7.50 Min 10.9 Max	91586-1
12 MM	5 ± 0.50	12.4 <sup>+2.0</sup> <sub>-0.0</sub>	18.4 Max	11.9 Min 15.4 Max	91586-2

Note: Surface resistivity is  $\geq 1 \times 10^5$  but  $< 1 \times 10^{12}$  ohm/sq.

Note: For the most current drawing please refer to IR website at: <http://www.irf.com/package/>

**Qualification information<sup>†</sup>**

Qualification level	Industrial <sup>††</sup> (per JEDEC JESD47F <sup>†††</sup> guidelines )	
Moisture Sensitivity Level	PQFN 2mm x 2mm	MSL1 (per IPC/JEDEC J-STD-020D <sup>†††</sup> )
RoHS compliant	Yes	

† Qualification standards can be found at International Rectifier's web site

<http://www.irf.com/product-info/reliability>

†† Higher qualification ratings may be available should the user have such requirements. Please contact your International Rectifier sales representative for further information:

<http://www.irf.com/whoto-call/salesrep/>

††† Applicable version of JEDEC standard at the time of product release.

**Revision History**

Date	Comment
5/12/2014	<ul style="list-style-type: none"> <li>• Updated ordering information to reflect the End-Of-life (EOL) of the mini-reel option (EOL notice #259)</li> <li>• Updated data sheet based on corporate template.</li> </ul>
5/21/2014	<ul style="list-style-type: none"> <li>• Updated qual level from "Consumer" to "Industrial" on page 1 &amp; 9.</li> </ul>

## Looking for pricing, stock, or lifecycle information?

Click below to explore more details on WIN SOURCE:

 [View IRFHS9301TR2PBF on WIN SOURCE](#)

 [Infineon Technologies](#) Information

## Optimize Your Supply Chain with WIN SOURCE Solutions

-  Global Sourcing Solution
-  Obsolete Management
-  Cost Control Management
-  Shortage Management
-  Alternative Solution
-  Excess Inventory Management