



**THE DATASHEET OF
IRFR3303TRLPBF**



IRFR3303PbF IRFU3303PbF

HEXFET® Power MOSFET

- Ultra Low On-Resistance
- Surface Mount (IRFR3303)
- Straight Lead (IRFU3303)
- Advanced Process Technology
- Fast Switching
- Fully Avalanche Rated
- Lead-Free

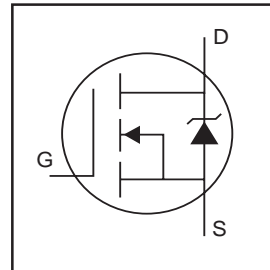

$V_{DSS} = 30V$
$R_{DS(on)} = 0.031\Omega$

Description

Fifth Generation HEXFETs from International Rectifier utilize advanced processing techniques to achieve extremely low on-resistance per silicon area. This benefit, combined with the fast switching speed and ruggedized device design that HEXFET Power MOSFETs are well known for, provides the designer with an extremely efficient and reliable device for use in a wide variety of applications.

The D-Pak is designed for surface mounting using vapor phase, infrared, or wave soldering techniques. The straight lead version (IRFU series) is for through-hole mounting applications. Power dissipation levels up to 1.5 watts are possible in typical surface mount applications.

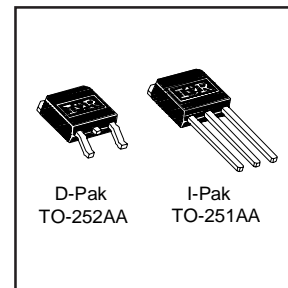

Absolute Maximum Ratings

	Parameter	Max.	Units
$I_D @ T_C = 25^\circ C$	Continuous Drain Current, $V_{GS} @ 10V$	33 [Ⓞ]	A
$I_D @ T_C = 100^\circ C$	Continuous Drain Current, $V_{GS} @ 10V$	21 [Ⓞ]	
I_{DM}	Pulsed Drain Current [Ⓛ]	120	
$P_D @ T_C = 25^\circ C$	Power Dissipation	57	W
	Linear Derating Factor	0.45	W/°C
V_{GS}	Gate-to-Source Voltage	± 20	V
E_{AS}	Single Pulse Avalanche Energy [Ⓞ]	95	mJ
I_{AR}	Avalanche Current [Ⓛ]	18	A
E_{AR}	Repetitive Avalanche Energy [Ⓛ]	5.7	mJ
dv/dt	Peak Diode Recovery dv/dt [Ⓞ]	5.0	V/ns
T_J	Operating Junction and	-55 to + 150	°C
T_{STG}	Storage Temperature Range		
	Soldering Temperature, for 10 seconds	300 (1.6mm from case)	

Thermal Resistance

	Parameter	Typ.	Max.	Units
$R_{\theta JC}$	Junction-to-Case	---	2.2	°C/W
$R_{\theta JA}$	Junction-to-Ambient (PCB mount)**	---	50	
$R_{\theta JA}$	Junction-to-Ambient	---	110	

IRFR/U3303PbF

International
 Rectifier

Electrical Characteristics @ T_J = 25°C (unless otherwise specified)

	Parameter	Min.	Typ.	Max.	Units	Conditions
V _{(BR)DSS}	Drain-to-Source Breakdown Voltage	30	—	—	V	V _{GS} = 0V, I _D = 250μA
ΔV _{(BR)DSS} /ΔT _J	Breakdown Voltage Temp. Coefficient	—	0.032	—	V/°C	Reference to 25°C, I _D = 1mA
R _{DS(on)}	Static Drain-to-Source On-Resistance	—	—	0.031	Ω	V _{GS} = 10V, I _D = 18A ④
V _{GS(th)}	Gate Threshold Voltage	2.0	—	4.0	V	V _{DS} = V _{GS} , I _D = 250μA
g _{fs}	Forward Transconductance	9.3	—	—	S	V _{DS} = 25V, I _D = 18A
I _{DSS}	Drain-to-Source Leakage Current	—	—	25	μA	V _{DS} = 30V, V _{GS} = 0V
		—	—	250		V _{DS} = 24V, V _{GS} = 0V, T _J = 150°C
I _{GSS}	Gate-to-Source Forward Leakage	—	—	100	nA	V _{GS} = 20V
	Gate-to-Source Reverse Leakage	—	—	-100		V _{GS} = -20V
Q _g	Total Gate Charge	—	—	29	nC	I _D = 18A
Q _{gs}	Gate-to-Source Charge	—	—	7.3		V _{DS} = 24V
Q _{gd}	Gate-to-Drain ("Miller") Charge	—	—	13		V _{GS} = 10V, See Fig. 6 and 13 ④
t _{d(on)}	Turn-On Delay Time	—	11	—	ns	V _{DD} = 15V
t _r	Rise Time	—	99	—		I _D = 18A
t _{d(off)}	Turn-Off Delay Time	—	16	—		R _G = 13Ω
t _f	Fall Time	—	28	—		R _D = 0.8Ω, See Fig. 10 ④
L _D	Internal Drain Inductance	—	4.5	—	nH	Between lead, 6mm (0.25in.) from package and center of die contact⑥
L _S	Internal Source Inductance	—	7.5	—		
C _{iss}	Input Capacitance	—	750	—	pF	V _{GS} = 0V
C _{oss}	Output Capacitance	—	400	—		V _{DS} = 25V
C _{rss}	Reverse Transfer Capacitance	—	140	—		f = 1.0MHz, See Fig. 5

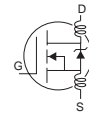

Source-Drain Ratings and Characteristics

	Parameter	Min.	Typ.	Max.	Units	Conditions
I _S	Continuous Source Current (Body Diode)	—	—	33⑤	A	MOSFET symbol showing the integral reverse p-n junction diode.
I _{SM}	Pulsed Source Current (Body Diode) ①	—	—	120		
V _{SD}	Diode Forward Voltage	—	—	1.3	V	T _J = 25°C, I _S = 18A, V _{GS} = 0V ④
t _{rr}	Reverse Recovery Time	—	53	80	ns	T _J = 25°C, I _F = 18A
Q _{rr}	Reverse Recovery Charge	—	94	140	nC	di/dt = 100A/μs ④
t _{on}	Forward Turn-On Time	Intrinsic turn-on time is negligible (turn-on is dominated by L _S +L _D)				

Notes:

- ① Repetitive rating; pulse width limited by max. junction temperature. (See fig. 11)
- ② Starting T_J = 25°C, L = 590μH
R_G = 25Ω, I_{AS} = 18A. (See Figure 12)
- ③ I_{SD} ≤ 18A, di/dt ≤ 140A/μs, V_{DD} ≤ V_{(BR)DSS}, T_J ≤ 150°C
- ④ Pulse width ≤ 300μs; duty cycle ≤ 2%.
- ⑤ Calculated continuous current based on maximum allowable junction temperature; Package limitation current = 20A.
- ⑥ This is applied for I-PAK, L_S of D-PAK is measured between lead and center of die contact

** When mounted on 1" square PCB (FR-4 or G-10 Material) .
 For recommended footprint and soldering techniques refer to application note #AN-994

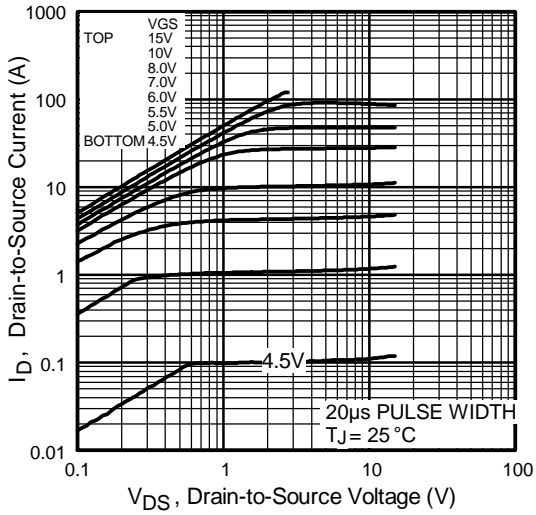

Fig 1. Typical Output Characteristics

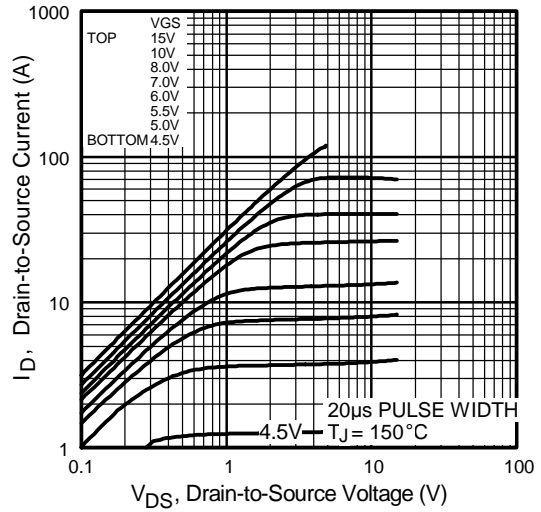

Fig 2. Typical Output Characteristics

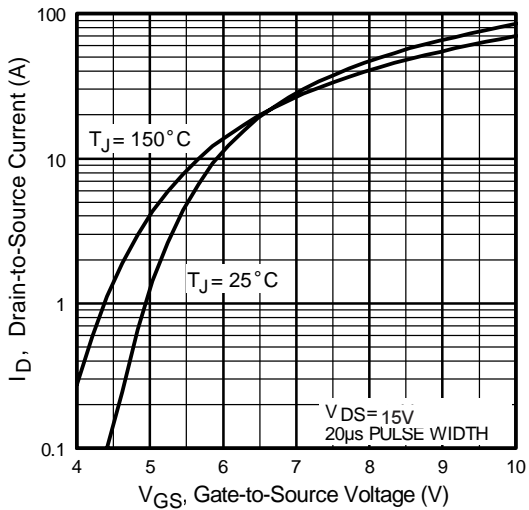

Fig 3. Typical Transfer Characteristics

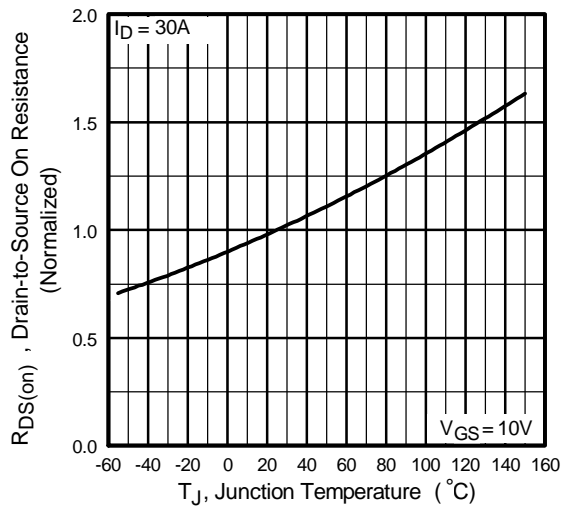

Fig 4. Normalized On-Resistance Vs. Temperature

IRFR/U3303PbF

International
IR Rectifier

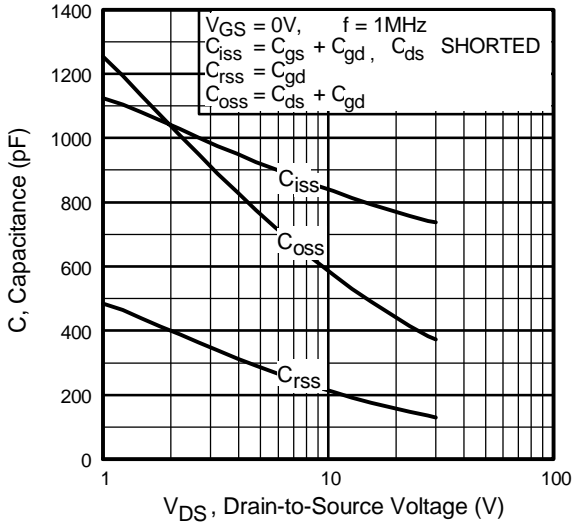

Fig 5. Typical Capacitance Vs. Drain-to-Source Voltage

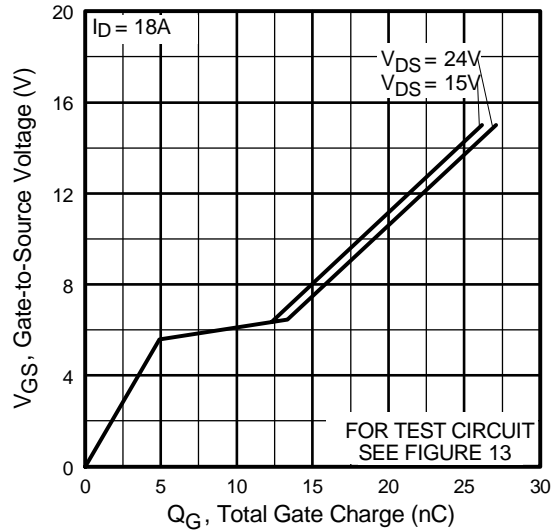

Fig 6. Typical Gate Charge Vs. Gate-to-Source Voltage

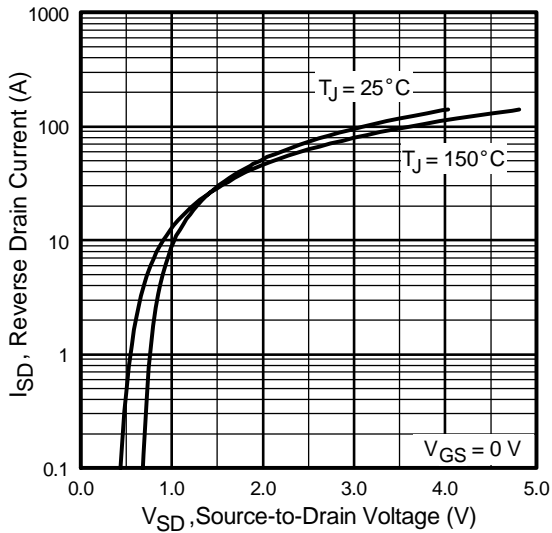

Fig 7. Typical Source-Drain Diode Forward Voltage

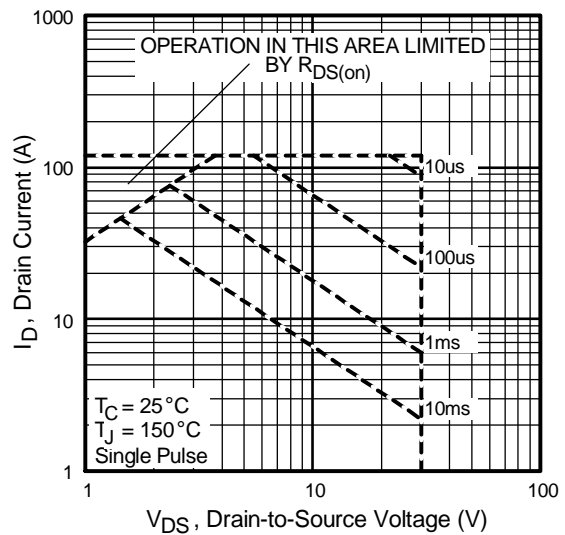

Fig 8. Maximum Safe Operating Area

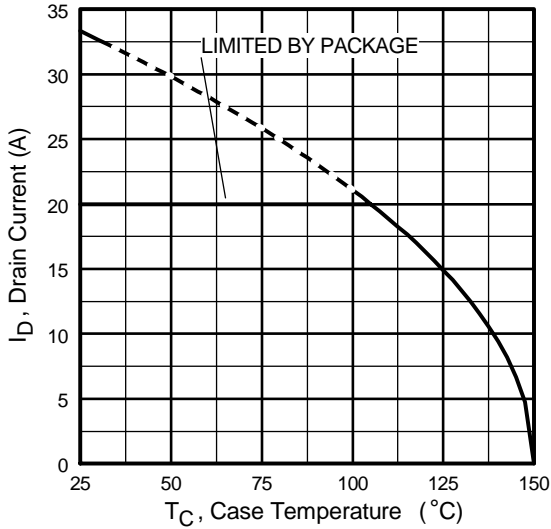

Fig 9. Maximum Drain Current Vs. Case Temperature

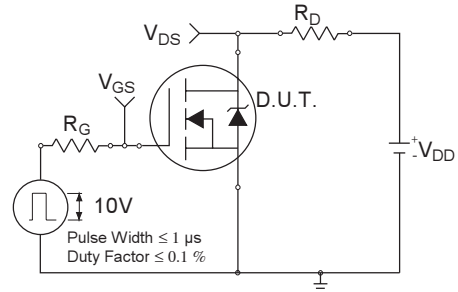

Fig 10a. Switching Time Test Circuit

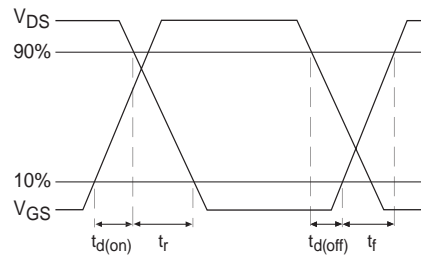

Fig 10b. Switching Time Waveforms

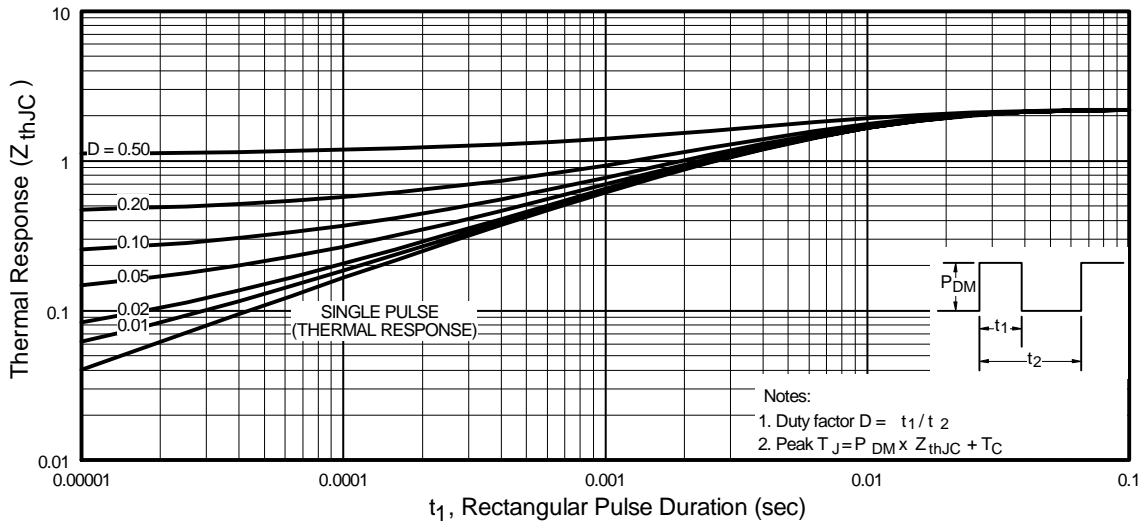

Fig 11. Maximum Effective Transient Thermal Impedance, Junction-to-Case

IRFR/U3303PbF

International
IOR Rectifier

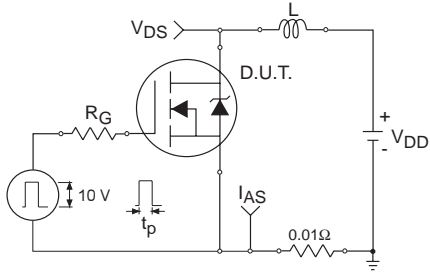

Fig 12a. Unclamped Inductive Test Circuit

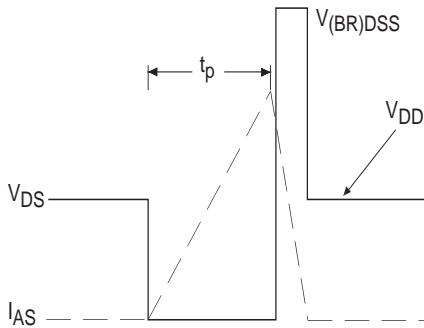

Fig 12b. Unclamped Inductive Waveforms

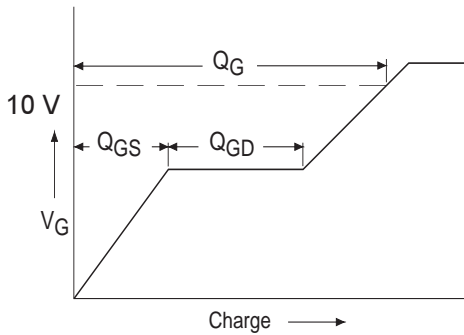

Fig 13a. Basic Gate Charge Waveform

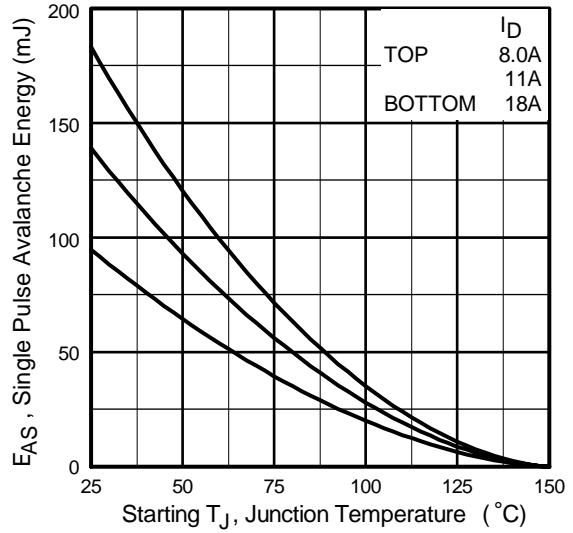

Fig 12c. Maximum Avalanche Energy Vs. Drain Current

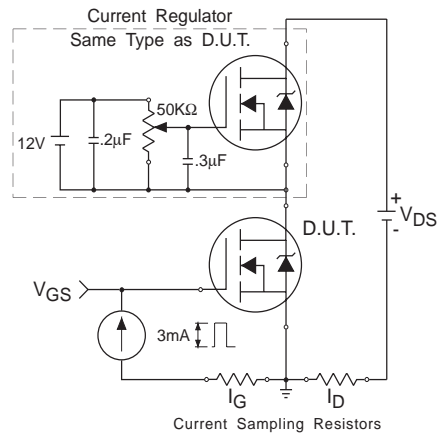
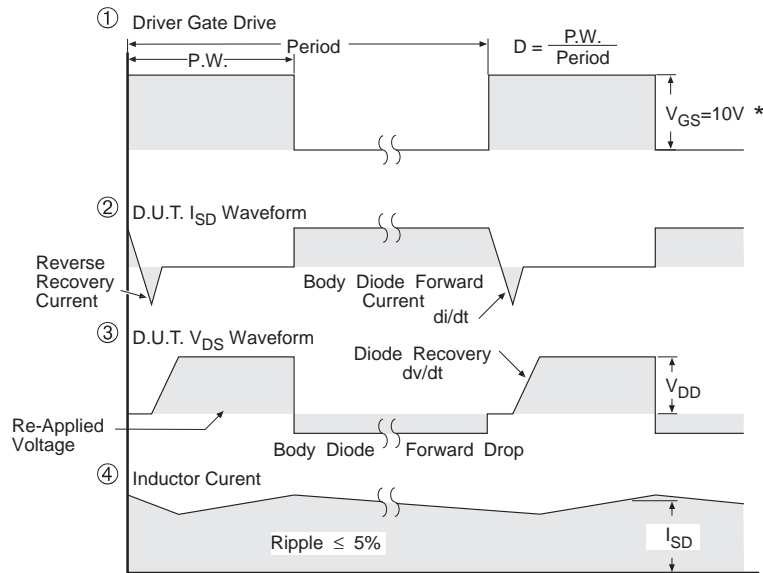
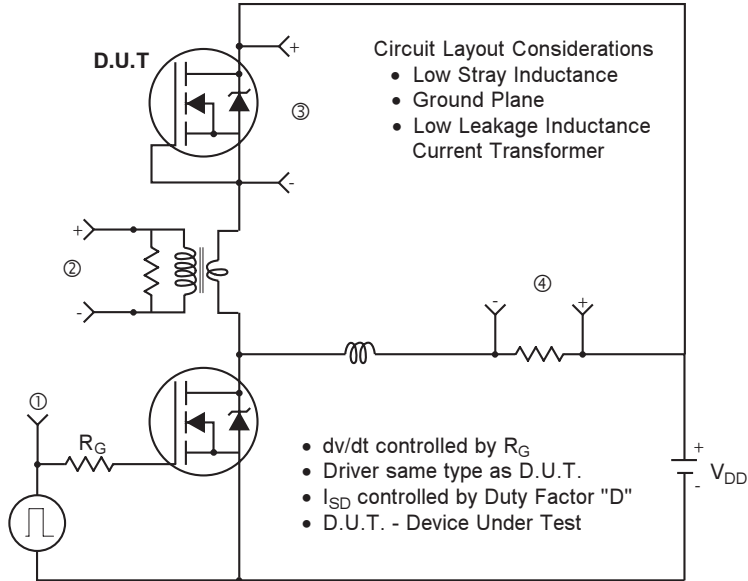

Fig 13b. Gate Charge Test Circuit

Peak Diode Recovery dv/dt Test Circuit



* $V_{GS} = 5V$ for Logic Level Devices

Fig 14. For N-Channel HEXFETS

IRFR/U3303PbF

International
IR Rectifier

D-Pak (TO-252AA) Package Outline

Dimensions are shown in millimeters (inches)

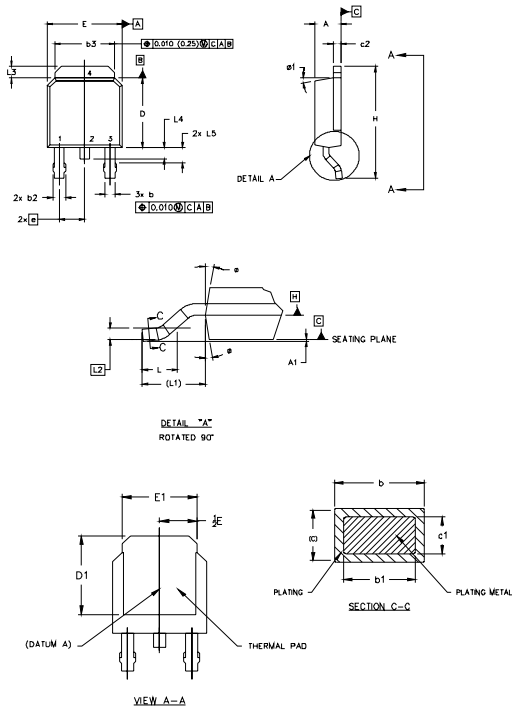

- NOTES:
- 1.0 DIMENSIONING AND TOLERANCING PER ASME Y14.5 M- 1994.
 - 2.0 DIMENSIONS ARE SHOWN IN INCHES [MILLIMETERS]
 - 3.0 LEAD DIMENSION UNCONTROLLED IN L5
 - 4.0 DIMENSION D1 AND E1 ESTABLISH A MINIMUM MOUNTING SURFACE FOR THERMAL PAD.
 - 5.0 SECTION C-C DIMENSIONS APPLY TO THE FLAT SECTION OF THE LEAD BETWEEN .005 [0.127] AND .010 [0.2540] FROM THE LEAD TIP.
 - 6.0 DIMENSION D & E DO NOT INCLUDE MOLD FLASH. MOLD FLASH SHALL NOT EXCEED .005" (0.127) PER SIDE. THESE DIMENSIONS ARE MEASURED AT THE OUTERMOST EXTREMES OF THE PLASTIC BODY.
 - 7.0 OUTLINE CONFORMS TO JEDEC OUTLINE TO-252AA.

SYMBOL	MILLIMETERS		INCHES		NOTES
	MIN.	MAX.	MIN.	MAX.	
A	2.18	2.39	.086	.094	
A1		0.13		.005	
b	0.64	0.89	.025	.035	5
b1	0.64	0.79	.025	0.031	5
b2	0.76	1.14	.030	.045	
b3	4.95	5.46	.195	.215	
c	0.46	0.61	.018	.024	5
c1	0.41	0.56	.016	.022	5
c2	0.46	0.89	.018	.035	5
D	5.97	6.22	.235	.245	6
D1	5.21	-	.205	-	4
E	6.35	6.73	.250	.265	6
E1	4.32	-	.170	-	4
e	2.29		.090	BSC	
H	9.40	10.41	.370	.410	
L	1.40	1.78	.055	.070	
L1	2.74	REF.	.108	REF.	
L2	0.051	BSC	.020	BSC	
L3	0.89	1.27	.035	.050	
L4		1.02		.040	
L5	1.14	1.52	.045	.060	3
ø	0"	10"	0"	10"	
ø1	0"	15"	0"	15"	

LEAD ASSIGNMENTS

HEXFET

- 1.- GATE
- 2.- DRAIN
- 3.- SOURCE
- 4.- DRAIN

IGBTs, CoPACK

- 1.- GATE
- 2.- COLLECTOR
- 3.- EMITTER
- 4.- COLLECTOR

D-Pak (TO-252AA) Part Marking Information

EXAMPLE: THIS IS AN IRFU120
WITH ASSEMBLY
LOT CODE 1234
ASSEMBLED ON WW 16, 1999
IN THE ASSEMBLY LINE "A"

Note: "P" in assembly line position
indicates "Lead-Free"

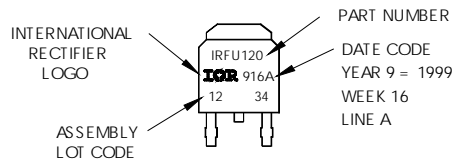

OR

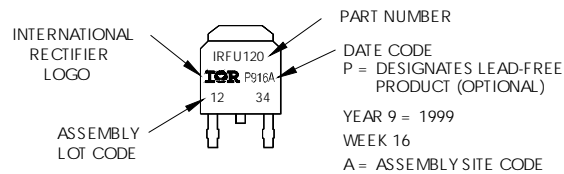

I-Pak (TO-251AA) Package Outline

Dimensions are shown in millimeters (inches)

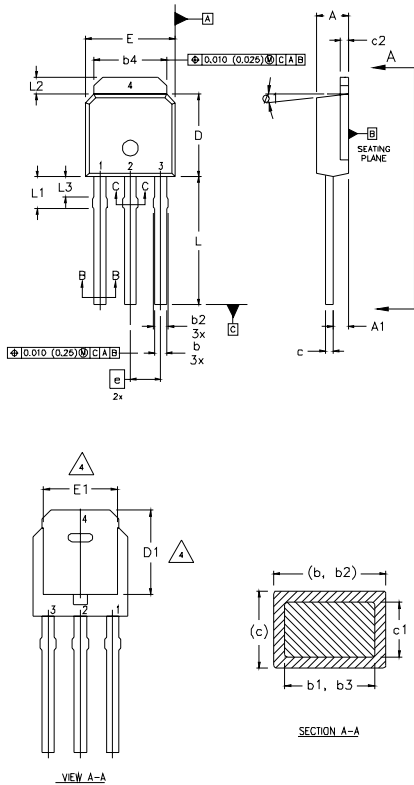

NOTES:

- 1 DIMENSIONING AND TOLERANCING PER ASME Y14.5 M- 1994.
- 2 DIMENSIONS ARE SHOWN IN MILLIMETERS [INCHES].
- 3 DIMENSION D & E DO NOT INCLUDE MOLD FLASH. MOLD FLASH SHALL NOT EXCEED 0.005" (0.127) PER SIDE. THESE DIMENSIONS ARE MEASURED AT THE OUTERMOST EXTREMES OF THE PLASTIC BODY.
- 4 THERMAL PAD CONTOUR OPTION WITHIN DIMENSION b4, L2, E1 & D1.
- 5 LEAD DIMENSION UNCONTROLLED IN L3.
- 6 DIMENSION b1, b3 APPLY TO BASE METAL ONLY.
- 7 OUTLINE CONFORMS TO JEDEC OUTLINE TO-251AA.
- 8 CONTROLLING DIMENSION : INCHES.

LEAD ASSIGNMENTS

HEXFEEET

- 1.- GATE
- 2.- DRAIN
- 3.- SOURCE
- 4.- DRAIN

SYMBOL	DIMENSIONS				NOTES
	MILLIMETERS		INCHES		
	MIN.	MAX.	MIN.	MAX.	
A	2.18	2.39	0.086	.094	
A1	0.89	1.14	0.035	0.045	
b	0.64	0.89	0.025	0.035	
b1	0.64	0.79	0.025	0.031	4
b2	0.76	1.14	0.030	0.045	
b3	0.76	1.04	0.030	0.041	
b4	5.00	5.46	0.195	0.215	4
c	0.46	0.61	0.018	0.024	
c1	0.41	0.56	0.016	0.022	
c2	.046	0.86	0.018	0.035	
D	5.97	6.22	0.235	0.245	3, 4
D1	5.21	-	0.205	-	4
E	6.35	6.73	0.250	0.265	3, 4
E1	4.32	-	0.170	-	4
e	2.29		0.090 BSC		
L	8.89	9.60	0.350	0.380	
L1	1.91	2.29	0.075	0.090	
L2	0.89	1.27	0.035	0.050	4
L3	1.14	1.52	0.045	0.060	5
ø1	0	15	0	15	

I-Pak (TO-251AA) Part Marking Information

EXAMPLE: THIS IS AN IRFU120 WITH ASSEMBLY LOT CODE 5678 ASSEMBLED ON WW19, 1999 IN THE ASSEMBLY LINE "A"
Note: "P" in assembly line position indicates "Lead-Free"

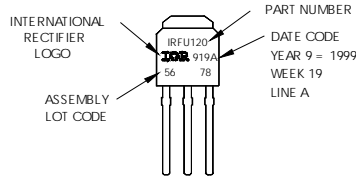

OR

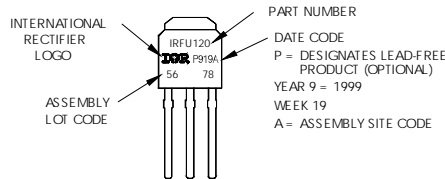

IRFR/U3303PbF

International
IOR Rectifier

D-Pak (TO-252AA) Tape & Reel Information

Dimensions are shown in millimeters (inches)

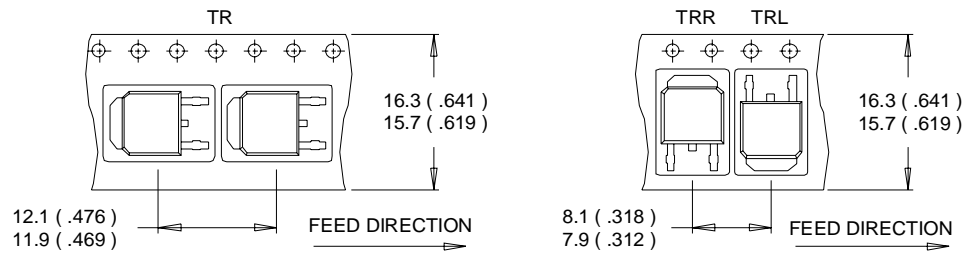

NOTES :

1. CONTROLLING DIMENSION : MILLIMETER.
2. ALL DIMENSIONS ARE SHOWN IN MILLIMETERS (INCHES).
3. OUTLINE CONFORMS TO EIA-481 & EIA-541.

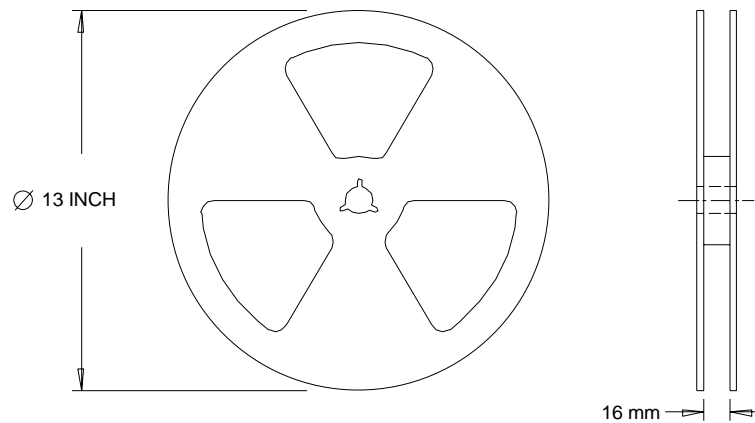

NOTES :

1. OUTLINE CONFORMS TO EIA-481.

Data and specifications subject to change without notice.

International
IOR Rectifier

IR WORLD HEADQUARTERS: 233 Kansas St., El Segundo, California 90245, USA Tel: (310) 252-7105
TAC Fax: (310) 252-7903

Visit us at www.irf.com for sales contact information.12/04

Note: For the most current drawings please refer to the IR website at:
<http://www.irf.com/package/>

Looking for pricing, stock, or lifecycle information?

Click below to explore more details on WIN SOURCE:

 [View IRFR3303TRLPBF on WIN SOURCE](#)

 [Infineon Technologies](#) Information

Optimize Your Supply Chain with WIN SOURCE Solutions

-  Global Sourcing Solution
-  Obsolete Management
-  Cost Control Management
-  Shortage Management
-  Alternative Solution
-  Excess Inventory Management