



**THE DATASHEET OF  
IRFS4020PBF**



**DIGITAL AUDIO MOSFET**

**IRFS4020PbF**  
**IRFSL4020PbF**

**Features**

- Key parameters optimized for Class-D audio amplifier applications
- Low  $R_{DS(ON)}$  for improved efficiency
- Low  $Q_G$  and  $Q_{SW}$  for better THD and improved efficiency
- Low  $Q_{RR}$  for better THD and lower EMI
- 175°C operating junction temperature for ruggedness
- Can deliver up to 300W per channel into 8Ω load in half-bridge configuration amplifier

Key Parameters		
$V_{DS}$	200	V
$R_{DS(ON)}$ typ. @ 10V	85	mΩ
$Q_g$ typ.	18	nC
$Q_{sw}$ typ.	6.7	nC
$R_{G(int)}$ typ.	3.2	Ω
$T_J$ max	175	°C

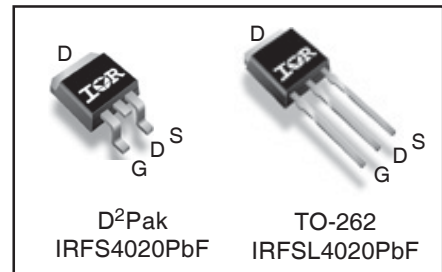
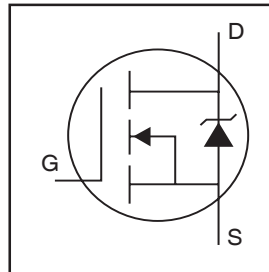

G	D	S
Gate	Drain	Source

**Description**

This Digital Audio MOSFET is specifically designed for Class-D audio amplifier applications. This MOSFET utilizes the latest processing techniques to achieve low on-resistance per silicon area. Furthermore, Gate charge, body-diode reverse recovery and internal Gate resistance are optimized to improve key Class-D audio amplifier performance factors such as efficiency, THD and EMI. Additional features of this MOSFET are 175°C operating junction temperature and repetitive avalanche capability. These features combine to make this MOSFET a highly efficient, robust and reliable device for ClassD audio amplifier applications.

**Absolute Maximum Ratings**

	Parameter	Max.	Units
$V_{DS}$	Drain-to-Source Voltage	200	V
$V_{GS}$	Gate-to-Source Voltage	±20	
$I_D @ T_C = 25^\circ C$	Continuous Drain Current, $V_{GS} @ 10V$	18	A
$I_D @ T_C = 100^\circ C$	Continuous Drain Current, $V_{GS} @ 10V$	13	
$I_{DM}$	Pulsed Drain Current ①	52	
$P_D @ T_C = 25^\circ C$	Power Dissipation ④	100	W
$P_D @ T_C = 100^\circ C$	Power Dissipation ④	52	
	Linear Derating Factor	0.70	W/°C
$T_J$	Operating Junction and Storage Temperature Range	-55 to + 175	°C
$T_{STG}$			
	Soldering Temperature, for 10 seconds (1.6mm from case)	300	

**Thermal Resistance**

	Parameter	Typ.	Max.	Units
$R_{\theta JC}$	Junction-to-Case ④	—	1.43	°C/W
$R_{\theta JA}$	Junction-to-Ambient (PCB Mount) ④	—	40	

Notes ① through ⑤ are on page 2

www.irf.com

## Electrical Characteristics @ $T_J = 25^\circ\text{C}$ (unless otherwise specified)

	Parameter	Min.	Typ.	Max.	Units	Conditions
$BV_{DSS}$	Drain-to-Source Breakdown Voltage	200	—	—	V	$V_{GS} = 0V, I_D = 250\mu A$
$\Delta BV_{DSS}/\Delta T_J$	Breakdown Voltage Temp. Coefficient	—	0.23	—	V/ $^\circ\text{C}$	Reference to $25^\circ\text{C}, I_D = 1\text{mA}$
$R_{DS(on)}$	Static Drain-to-Source On-Resistance	—	85	105	m $\Omega$	$V_{GS} = 10V, I_D = 11A$ ③
$V_{GS(th)}$	Gate Threshold Voltage	3.0	—	4.9	V	$V_{DS} = V_{GS}, I_D = 100\mu A$
$\Delta V_{GS(th)}/\Delta T_J$	Gate Threshold Voltage Coefficient	—	-13	—	mV/ $^\circ\text{C}$	
$I_{DSS}$	Drain-to-Source Leakage Current	—	—	20	$\mu A$	$V_{DS} = 200V, V_{GS} = 0V$
		—	—	250		$V_{DS} = 200V, V_{GS} = 0V, T_J = 125^\circ\text{C}$
$I_{GSS}$	Gate-to-Source Forward Leakage	—	—	100	nA	$V_{GS} = 20V$
	Gate-to-Source Reverse Leakage	—	—	-100		$V_{GS} = -20V$
$g_{fs}$	Forward Transconductance	24	—	—	S	$V_{DS} = 50V, I_D = 11A$
$Q_g$	Total Gate Charge	—	18	29	nC	$V_{DS} = 100V$ $V_{GS} = 10V$ $I_D = 11A$ See Fig. 6 and 18
$Q_{gs1}$	Pre-V <sub>th</sub> Gate-to-Source Charge	—	4.5	—		
$Q_{gs2}$	Post-V <sub>th</sub> Gate-to-Source Charge	—	1.4	—		
$Q_{gd}$	Gate-to-Drain Charge	—	5.3	—		
$Q_{godr}$	Gate Charge Overdrive	—	6.8	—		
$Q_{sw}$	Switch Charge ( $Q_{gs2} + Q_{gd}$ )	—	6.7	—		
$R_{G(int)}$	Internal Gate Resistance	—	3.2	—	$\Omega$	
$t_{d(on)}$	Turn-On Delay Time	—	7.8	—	ns	$V_{DD} = 100V, V_{GS} = 10V$ ③ $I_D = 11A$ $R_G = 2.4\Omega$
$t_r$	Rise Time	—	12	—		
$t_{d(off)}$	Turn-Off Delay Time	—	16	—		
$t_f$	Fall Time	—	6.3	—		
$C_{iss}$	Input Capacitance	—	1200	—	pF	$V_{GS} = 0V$ $V_{DS} = 50V$ $f = 1.0\text{MHz}$ , See Fig.5 $V_{GS} = 0V, V_{DS} = 0V$ to $160V$
$C_{oss}$	Output Capacitance	—	91	—		
$C_{rss}$	Reverse Transfer Capacitance	—	20	—		
$C_{oss\ eff.}$	Effective Output Capacitance	—	110	—		
$L_D$	Internal Drain Inductance	—	4.5	—	nH	Between lead, 6mm (0.25in.) from package and center of die contact
$L_S$	Internal Source Inductance	—	7.5	—		

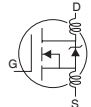

## Avalanche Characteristics

	Parameter	Typ.	Max.	Units
$E_{AS}$	Single Pulse Avalanche Energy ②	—	94	mJ
$I_{AR}$	Avalanche Current ⑤	See Fig. 14, 15, 16a, 16b		A
$E_{AR}$	Repetitive Avalanche Energy ⑤			mJ

## Diode Characteristics

	Parameter	Min.	Typ.	Max.	Units	Conditions
$I_S @ T_C = 25^\circ\text{C}$	Continuous Source Current (Body Diode)	—	—	18	A	MOSFET symbol showing the integral reverse p-n junction diode.
$I_{SM}$	Pulsed Source Current (Body Diode) ①	—	—	52		
$V_{SD}$	Diode Forward Voltage	—	—	1.3	V	$T_J = 25^\circ\text{C}, I_S = 11A, V_{GS} = 0V$ ③
$t_{rr}$	Reverse Recovery Time	—	82	120	ns	$T_J = 25^\circ\text{C}, I_F = 11A$
$Q_{rr}$	Reverse Recovery Charge	—	280	420	nC	$di/dt = 100A/\mu s$ ③

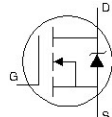

### Notes:

- ① Repetitive rating; pulse width limited by max. junction temperature.
- ② Starting  $T_J = 25^\circ\text{C}$ ,  $L = 1.62\text{mH}$ ,  $R_G = 25\Omega$ ,  $I_{AS} = 11A$ .
- ③ Pulse width  $\leq 400\mu s$ ; duty cycle  $\leq 2\%$ .
- ④  $R_{\theta}$  is measured at  $T_J$  of approximately  $90^\circ\text{C}$ .
- ⑤ Limited by  $T_{jmax}$ . See Figs. 14, 15, 17a, 17b for repetitive avalanche information.

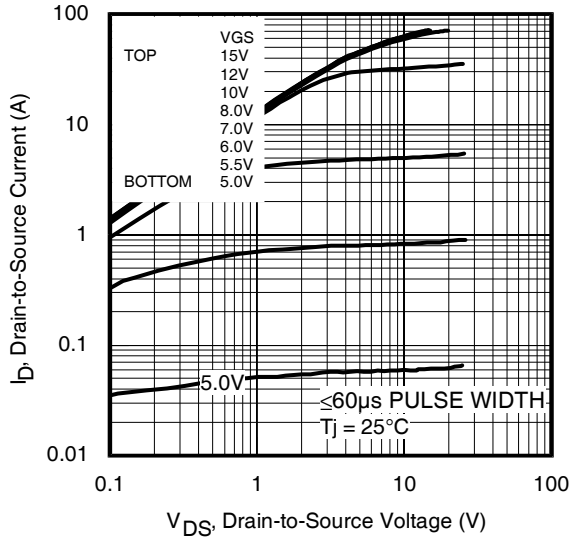

**Fig 1.** Typical Output Characteristics

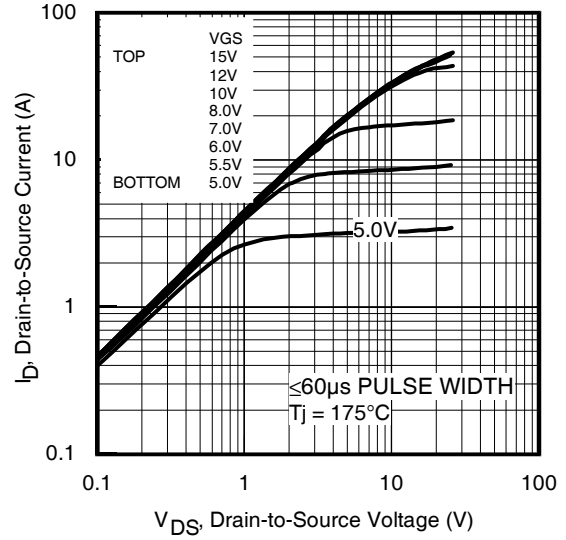

**Fig 2.** Typical Output Characteristics

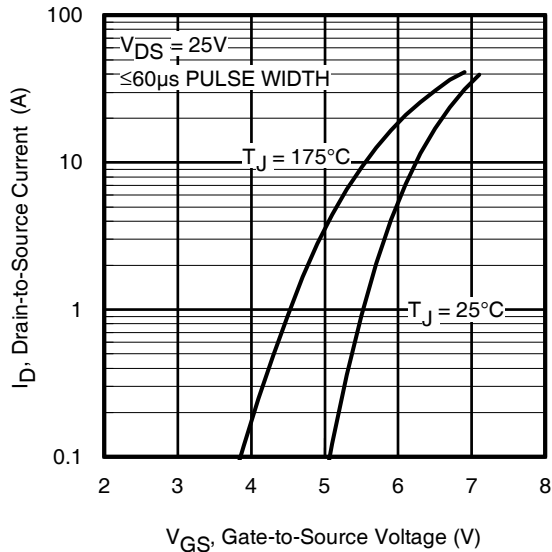

**Fig 3.** Typical Transfer Characteristics

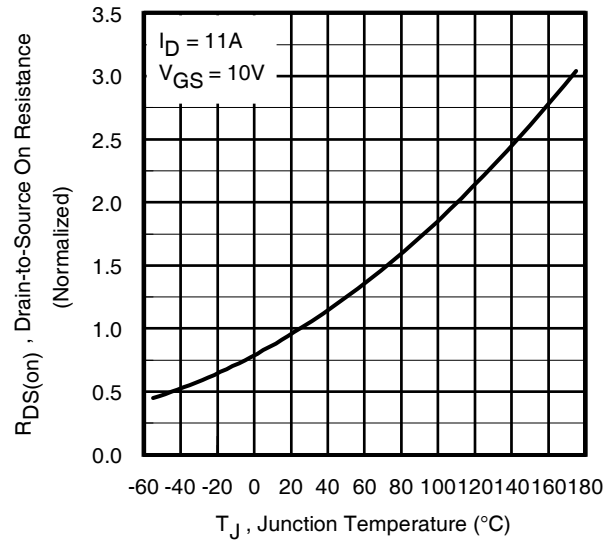

**Fig 4.** Normalized On-Resistance vs. Temperature

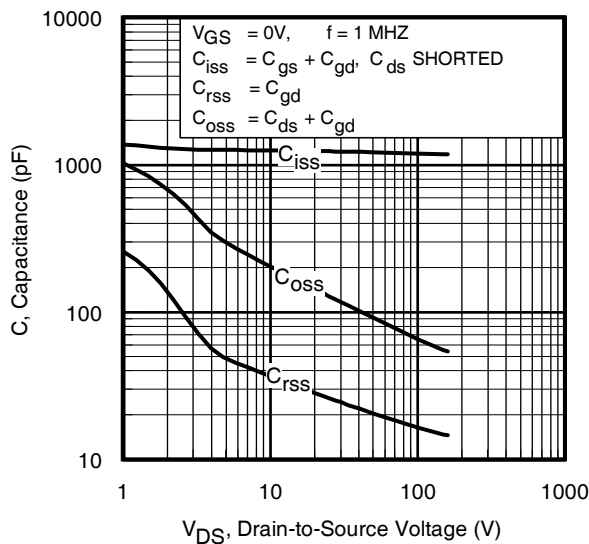

**Fig 5.** Typical Capacitance vs. Drain-to-Source Voltage  
www.irf.com

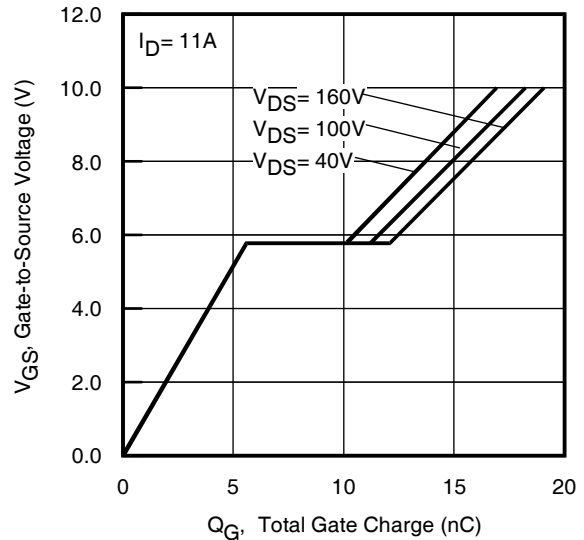

**Fig 6.** Typical Gate Charge vs. Gate-to-Source Voltage

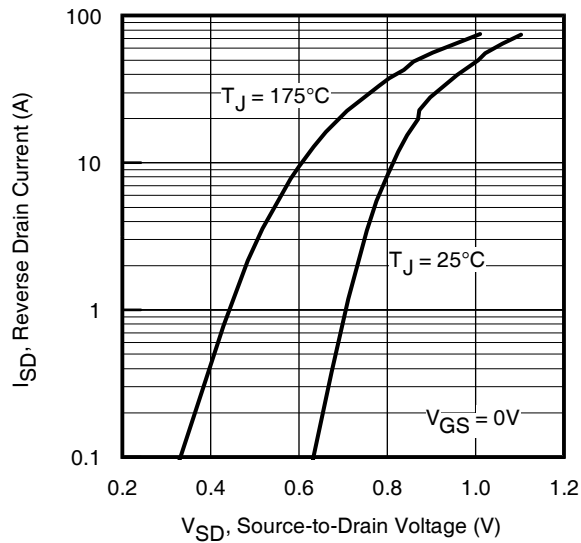

**Fig 7.** Typical Source-Drain Diode Forward Voltage

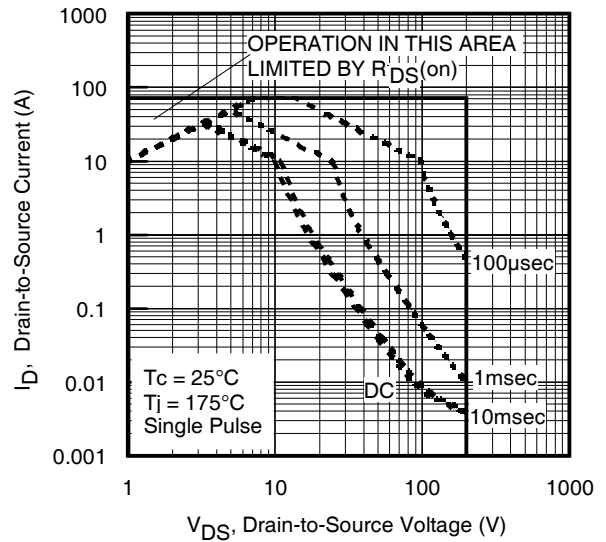

**Fig 8.** Maximum Safe Operating Area

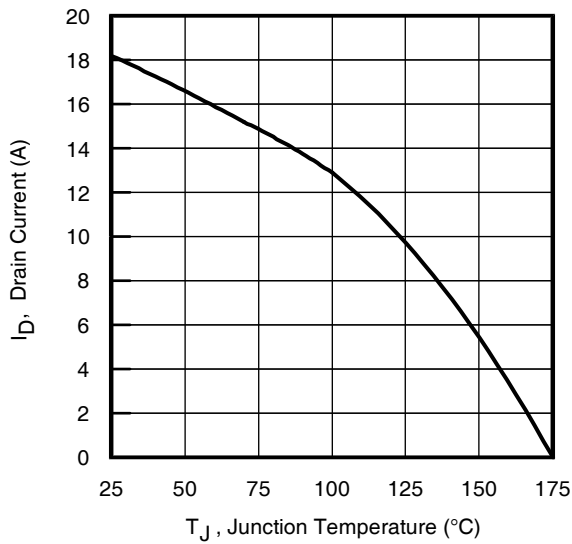

**Fig 9.** Maximum Drain Current vs. Junction Temperature

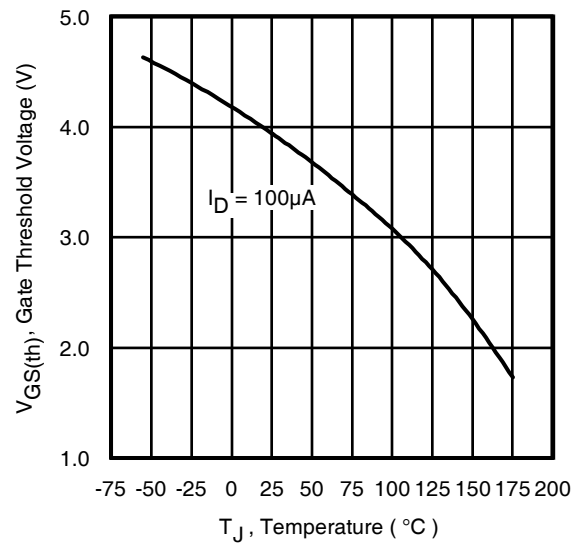

**Fig 10.** Threshold Voltage vs. Temperature

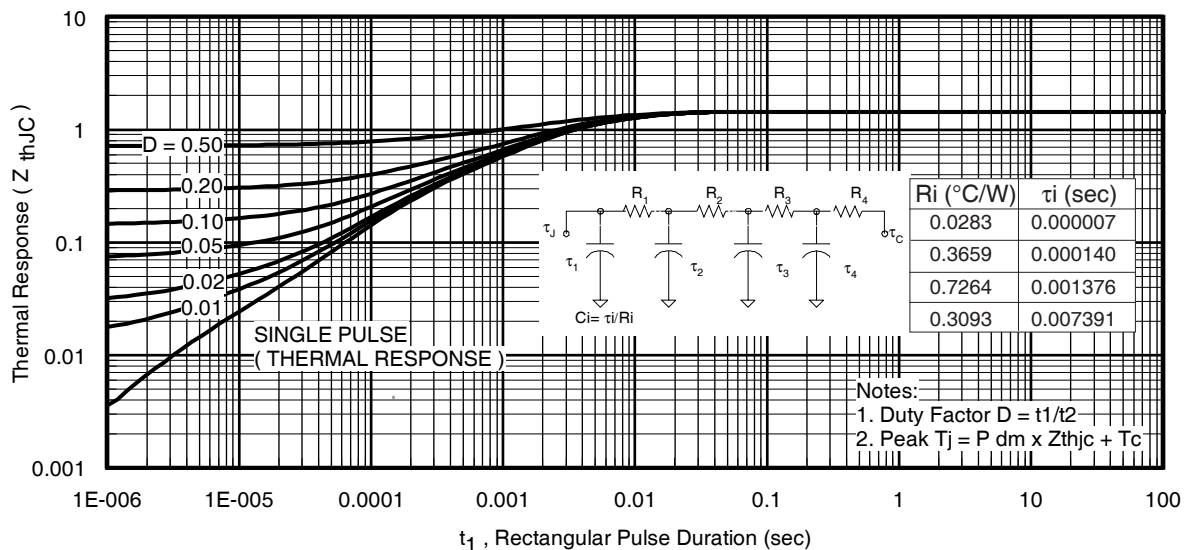

**Fig 11.** Maximum Effective Transient Thermal Impedance, Junction-to-Case

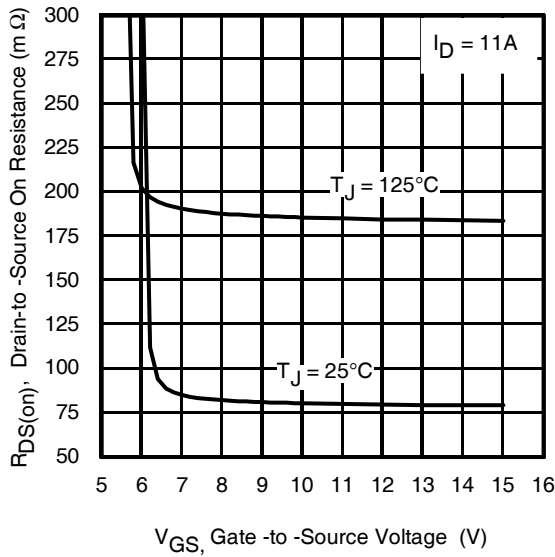

Fig 12. On-Resistance vs. Gate Voltage

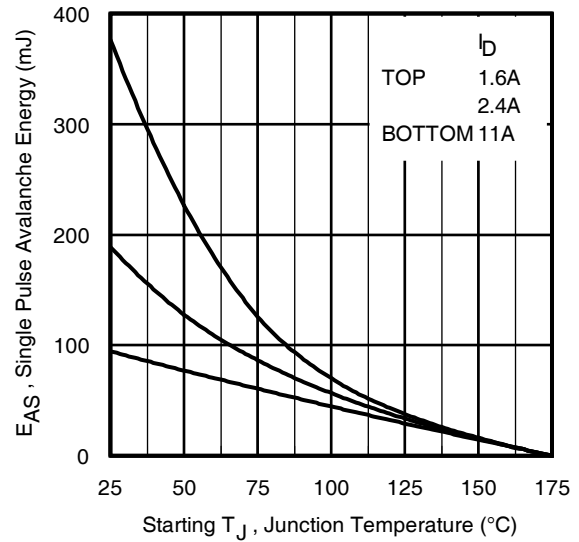

Fig 13. Maximum Avalanche Energy vs. Drain Current

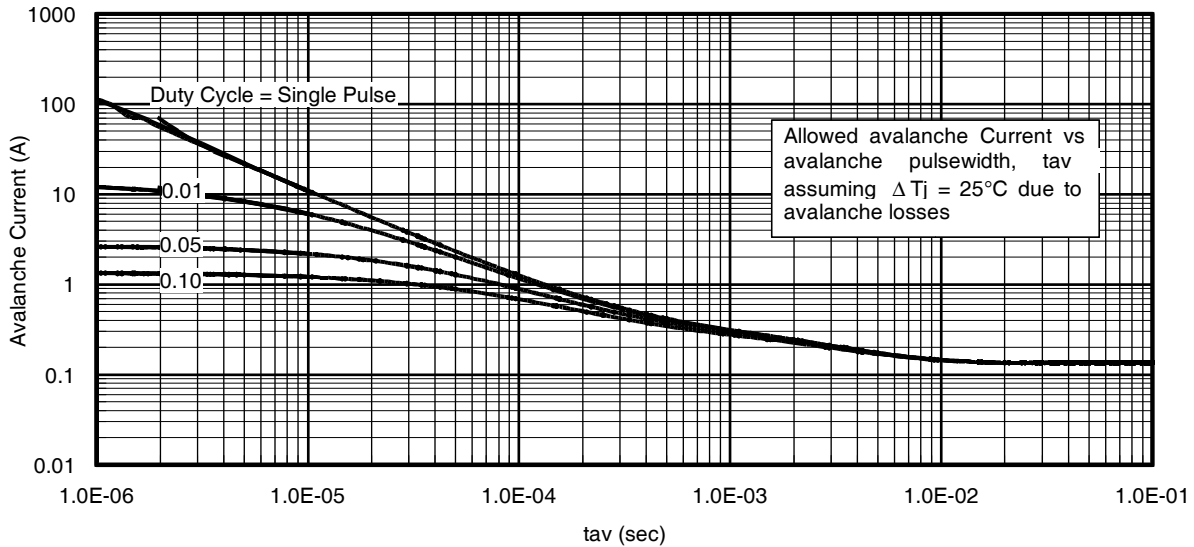

Fig 14. Typical Avalanche Current Vs. Pulsewidth

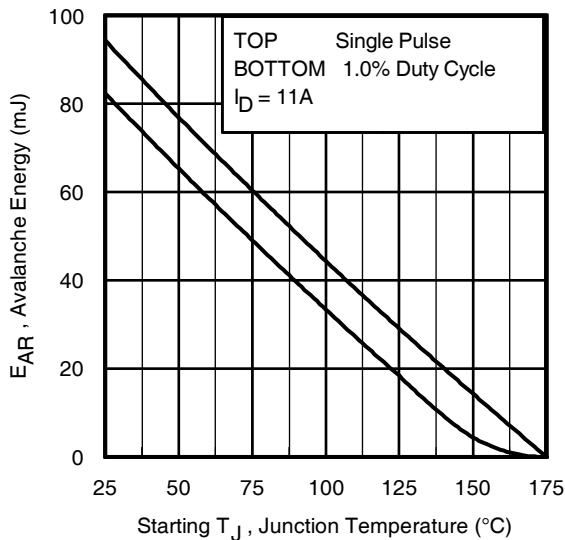

Fig 15. Maximum Avalanche Energy vs. Temperature

**Notes on Repetitive Avalanche Curves , Figures 14, 15:**  
(For further info, see AN-1005 at [www.irf.com](http://www.irf.com))

1. Avalanche failures assumption:  
Purely a thermal phenomenon and failure occurs at a temperature far in excess of  $T_{jmax}$ . This is validated for every part type.
2. Safe operation in Avalanche is allowed as long as  $T_{jmax}$  is not exceeded.
3. Equation below based on circuit and waveforms shown in Figures 17a, 17b.
4.  $P_D(ave)$  = Average power dissipation per single avalanche pulse.
5.  $BV$  = Rated breakdown voltage (1.3 factor accounts for voltage increase during avalanche).
6.  $I_{av}$  = Allowable avalanche current.
7.  $\Delta T$  = Allowable rise in junction temperature, not to exceed  $T_{jmax}$  (assumed as 25°C in Figure 14, 15).  
 $t_{av}$  = Average time in avalanche.  
 $D$  = Duty cycle in avalanche =  $t_{av} \cdot f$   
 $Z_{thJC}(D, t_{av})$  = Transient thermal resistance, see figure 11)

$$P_D(ave) = 1/2 ( 1.3 \cdot BV \cdot I_{av} ) = \Delta T / Z_{thJC}$$

$$I_{av} = 2\Delta T / [ 1.3 \cdot BV \cdot Z_{thJC} ]$$

$$E_{AS}(AR) = P_D(ave) \cdot t_{av}$$

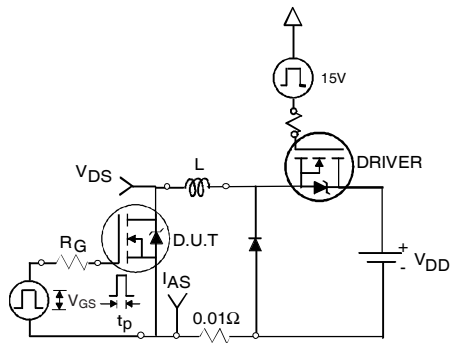

**Fig 16a.** Unclamped Inductive Test Circuit

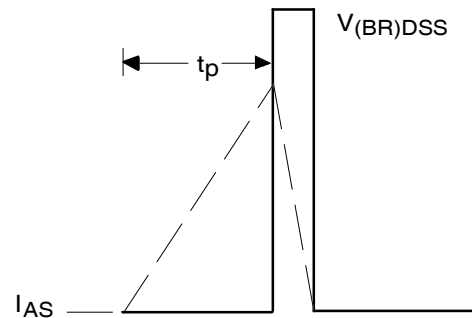

**Fig 16b.** Unclamped Inductive Waveforms

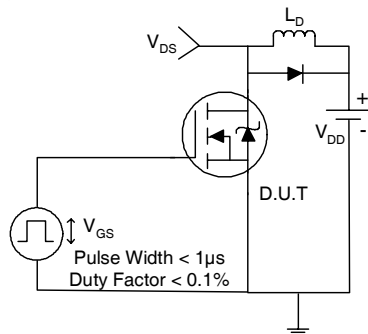

**Fig 17a.** Switching Time Test Circuit

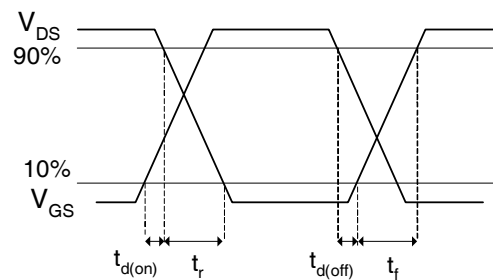

**Fig 17b.** Switching Time Waveforms

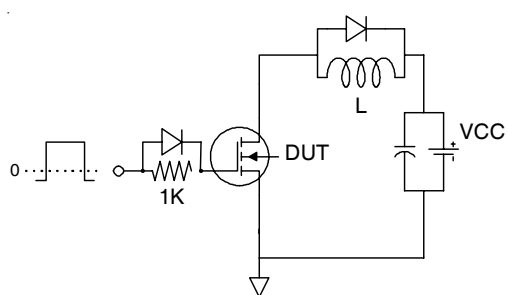

**Fig 18a.** Gate Charge Test Circuit

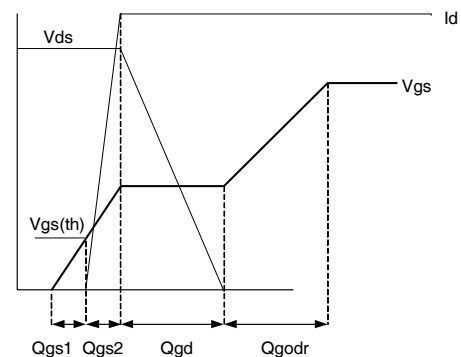

**Fig 18b** Gate Charge Waveform

## D<sup>2</sup>Pak (TO-263AB) Package Outline

Dimensions are shown in millimeters (inches)

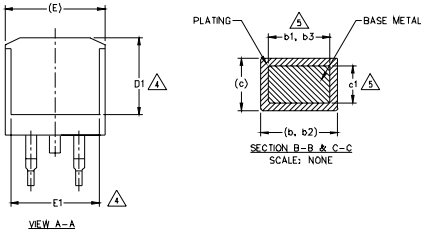
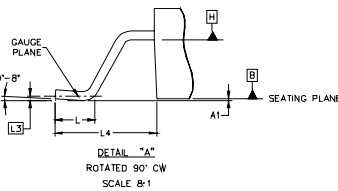
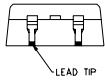
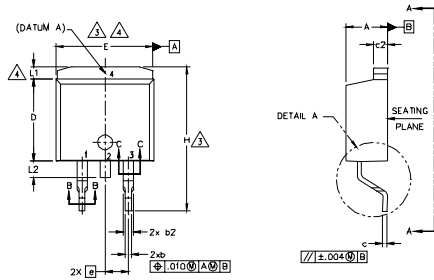

**LEAD ASSIGNMENTS**

**DIODES**

- 1.- ANODE (TWO DIE) / OPEN (ONE DIE)
  - 2, 4.- CATHODE
  - 3.- ANODE
- HEXFET**
- 1.- GATE
  - 2, 4.- DRAIN
  - 3.- SOURCE

**IGBTs, CoPACK**

- 1.- GATE
- 2, 4.- COLLECTOR
- 3.- EMITTER

SYMBOL	DIMENSIONS				NOTES
	MILLIMETERS		INCHES		
	MIN.	MAX.	MIN.	MAX.	
A	4.06	4.83	.160	.190	5
A1	0.00	0.254	.000	.010	
b	0.51	0.99	.020	.039	5
b1	0.51	0.89	.020	.035	
b2	1.14	1.78	.045	.070	5
b3	1.14	1.73	.045	.068	
c	0.38	0.74	.015	.029	5
c1	0.38	0.58	.015	.023	
c2	1.14	1.65	.045	.065	3
D	8.38	9.65	.330	.380	
D1	6.86	-	.270	-	4
E	9.65	10.67	.380	.420	3,4
E1	6.22	-	.245	-	4
e	2.54 BSC		.100 BSC		4
H	14.61	15.88	.575	.625	
L	1.78	2.79	.070	.110	4
L1	-	1.65	-	.066	
L2	-	1.78	-	.070	4
L3	0.25 BSC		.010 BSC		
L4	4.78	5.28	.188	.208	

**NOTES:**

1. DIMENSIONING AND TOLERANCING PER ASME Y14.5M-1994
2. DIMENSIONS ARE SHOWN IN MILLIMETERS [INCHES].
3. DIMENSION D & E DO NOT INCLUDE MOLD FLASH. MOLD FLASH SHALL NOT EXCEED 0.127 [0.005"] PER SIDE. THESE DIMENSIONS ARE MEASURED AT THE OUTMOST EXTREMES OF THE PLASTIC BODY AT DATUM H.
4. THERMAL PAD CONTOUR OPTIONAL WITHIN DIMENSION E, L1, D1 & E1.
5. DIMENSION b1 AND c1 APPLY TO BASE METAL ONLY.
6. DATUM A & B TO BE DETERMINED AT DATUM PLANE H.
7. CONTROLLING DIMENSION: INCH.
8. OUTLINE CONFORMS TO JEDEC OUTLINE TO-263AB.

## D<sup>2</sup>Pak (TO-263AB) Part Marking Information

EXAMPLE: THIS IS AN IRF530S WITH  
LOT CODE 8024  
ASSEMBLED ON WW 02, 2000  
IN THE ASSEMBLY LINE "L"

Note: "P" in assembly line position  
indicates "Lead - Free"

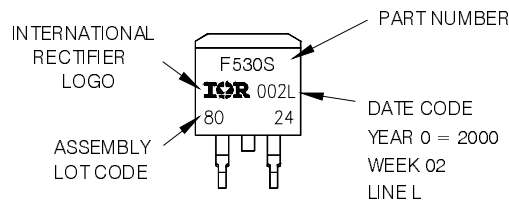

OR

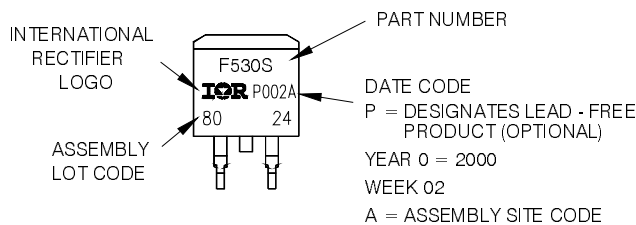

Note: For the most current drawing please refer to IR website at <http://www.irf.com/package/>

# IRFS/SL4020PbF

## TO-262 Package Outline

Dimensions are shown in millimeters (inches)

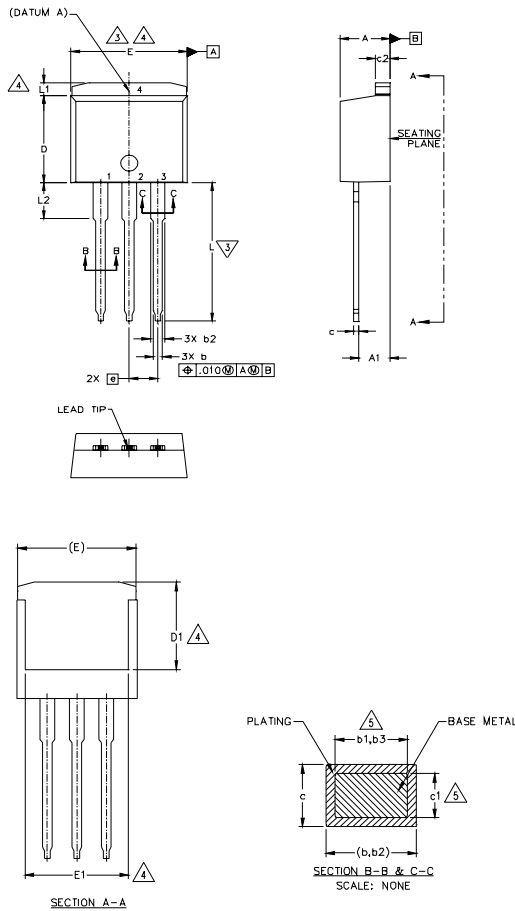

SYMBOL	DIMENSIONS				NOTES
	MILLIMETERS		INCHES		
	MIN.	MAX.	MIN.	MAX.	
A	4.06	4.83	.160	.190	5
A1	2.03	3.02	.080	.119	
b	0.51	0.99	.020	.039	
b1	0.51	0.89	.020	.035	
b2	1.14	1.78	.045	.070	
b3	1.14	1.73	.045	.068	5
c	0.38	0.74	.015	.029	
c1	0.38	0.58	.015	.023	5
c2	1.14	1.65	.045	.065	
D	8.38	9.65	.330	.380	3
D1	6.86	—	.270	—	4
E	9.65	10.67	.380	.420	3,4
E1	6.22	—	.245	—	
e	2.54 BSC		.100 BSC		4
L	13.46	14.10	.530	.555	
L1	—	1.65	—	.065	4
L2	3.56	3.71	.140	.146	

- NOTES:
1. DIMENSIONING AND TOLERANCING PER ASME Y14.5M-1994
  2. DIMENSIONS ARE SHOWN IN MILLIMETERS (INCHES).
  3. DIMENSION D & E DO NOT INCLUDE MOLD FLASH. MOLD FLASH SHALL NOT EXCEED 0.127 (0.005) PER SIDE. THESE DIMENSIONS ARE MEASURED AT THE OUTMOST EXTREMES OF THE PLASTIC BODY.
  4. THERMAL PAD CONTOUR OPTIONAL WITHIN DIMENSION E, L1, D1 & E1.
  5. DIMENSION b1 AND c1 APPLY TO BASE METAL ONLY.
  6. CONTROLLING DIMENSION: INCH.
  7. OUTLINE CONFORM TO JEDEC TO-262 EXCEPT A1(max.), b(min.), b(max.), AND D1(min.) WHERE DIMENSIONS DERIVED THE ACTUAL PACKAGE OUTLINE.

LEAD ASSIGNMENTS

- IRBTA Co-PACK
- 1.- GATE
  - 2.- COLLECTOR
  - 3.- EMITTER
  - 4.- COLLECTOR

HEXLET DIODES

- 1.- GATE
- 2.- DRAIN
- 3.- SOURCE
- 4.- DRAIN
- 1.- ANODE (NO DE) / OPEN (NO DE)
- 2.- CATHODE
- 3.- ANODE

## TO-262 Part Marking Information

EXAMPLE: THIS IS AN IRL3103L  
LOT CODE 1789  
ASSEMBLED ON WW 19, 1997  
IN THE ASSEMBLY LINE 'C'

Note: "P" in assembly line position indicates "Lead - Free"

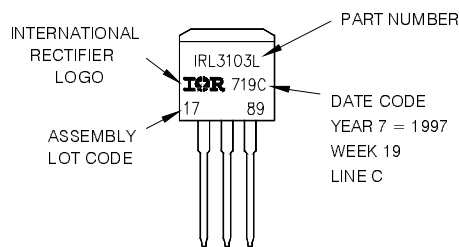

OR

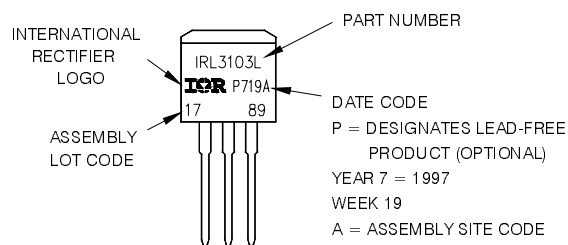

Note: For the most current drawing please refer to IR website at <http://www.irf.com/package/>

## D<sup>2</sup>Pak (TO-263AB) Tape & Reel Information

Dimensions are shown in millimeters (inches)

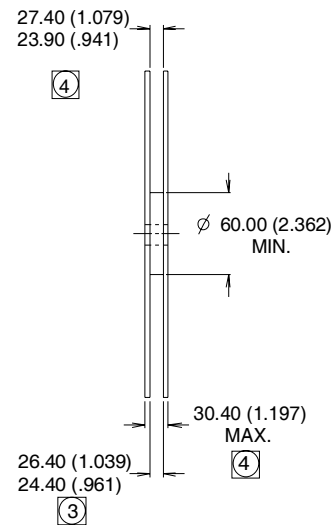
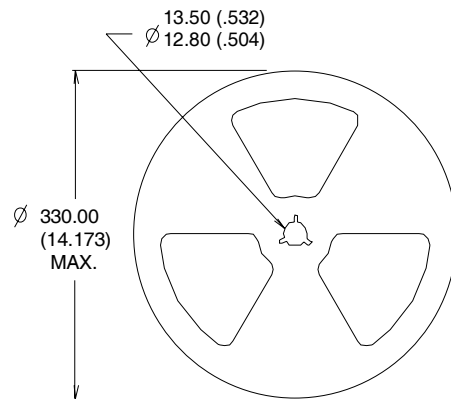
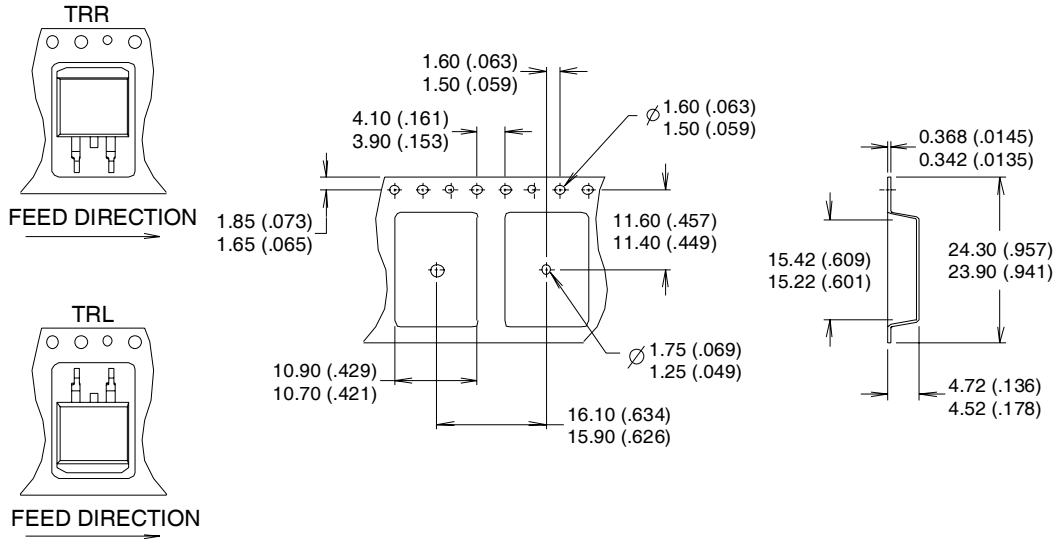

**NOTES :**

1. COMFORMS TO EIA-418.
2. CONTROLLING DIMENSION: MILLIMETER.
- ③ DIMENSION MEASURED @ HUB.
- ④ INCLUDES FLANGE DISTORTION @ OUTER EDGE.

**Note:** For the most current drawing please refer to IR website at <http://www.irf.com/package/>

Data and specifications subject to change without notice.  
 This product has been designed and qualified for the Industrial market.  
 Qualification Standards can be found on IR's Web site.

## Looking for pricing, stock, or lifecycle information?

Click below to explore more details on WIN SOURCE:

-  [View IRFS4020PBF on WIN SOURCE](#)
-  [Infineon Technologies](#) Information

## Optimize Your Supply Chain with WIN SOURCE Solutions

-  Global Sourcing Solution
-  Obsolete Management
-  Cost Control Management
-  Shortage Management
-  Alternative Solution
-  Excess Inventory Management