



**THE DATASHEET OF
IRFU3704PBF**



SMPS MOSFET

IRFR3704PbF
IRFU3704PbF

HEXFET® Power MOSFET

Applications

- High Frequency DC-DC Isolated Converters with Synchronous Rectification for Telecom and Industrial use
- High Frequency Buck Converters for Computer Processor Power
- 100% R_G Tested
- Lead-Free

V_{DSS}	R_{DS(on)} max	I_D
20V	9.5mΩ	75A

Benefits

- Ultra-Low R_{DS(on)}
- Very Low Gate Impedance
- Fully Characterized Avalanche Voltage and Current

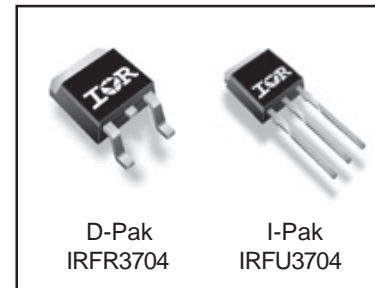

Absolute Maximum Ratings

Symbol	Parameter	Max	Units
V _{DS}	Drain-Source Voltage	20	V
V _{GS}	Gate-Source Voltage	± 20	
I _D @ T _C = 25°C	Continuous Drain Current, V _{GS} @ 10V	75 ④	A
I _D @ T _C = 70°C	Continuous Drain Current, V _{GS} @ 10V	63 ④	
I _{DM}	Pulsed Drain Current ①	300	
P _D @ T _C = 25°C	Maximum Power Dissipation ③	90	W
P _D @ T _A = 70°C	Maximum Power Dissipation ③	62	
	Linear Derating Factor	0.58	W/°C
T _J , T _{STG}	Junction and Storage Temperature Range	-55 to +175	°C

Thermal Resistance

Symbol	Parameter	Typ	Max	Units
R _{θJC}	Junction-to-Case ②	—	1.7	°C/W
R _{θJA}	Junction-to-Ambient (PCB Mount) *⑤	—	50	
R _{θJA}	Junction-to-Ambient ⑤	—	110	

* When mounted on 1" square PCB (FR-4 or G-10 Material) .
 For recommended footprint and soldering techniques refer to application note #AN-994

Notes ① through ⑤ are on page 9

Static @ T_J = 25°C (unless otherwise specified)

Symbol	Parameter	Min	Typ	Max	Units	Conditions
V _{(BR)DSS}	Drain-to-Source Breakdown Voltage	20	—	—	V	V _{GS} = 0V, I _D = 250μA
ΔV _{(BR)DSS} /ΔT _J	Breakdown Voltage Temp. Coefficient	—	0.021	—	V/°C	Reference to 25°C, I _D = 1mA
R _{DS(on)}	Static Drain-to-Source On-Resistance	—	7.3	9.5	mΩ	V _{GS} = 10V, I _D = 15A ③ V _{GS} = 4.5V, I _D = 12A ③
V _{GS(th)}	Gate Threshold Voltage	1.0	—	3.0	V	V _{DS} = V _{GS} , I _D = 250μA
I _{DSS}	Drain-to-Source Leakage Current	—	—	10	μA	V _{DS} = 20V, V _{GS} = 0V V _{DS} = 16V, V _{GS} = 0V, T _J = 125°C
I _{GSS}	Gate-to-Source Forward Leakage	—	—	200	nA	V _{GS} = 16V
	Gate-to-Source Reverse Leakage	—	—	-200	nA	V _{GS} = -16V

Dynamic @ T_J = 25°C (unless otherwise specified)

Symbol	Parameter	Min	Typ	Max	Units	Conditions
g _{fs}	Forward Transconductance	42	—	—	S	V _{DS} = 25V, I _D = 57A
Q _g	Total Gate Charge	—	19	—	nC	I _D = 28.4A V _{DS} = 10V V _{GS} = 4.5V ③ V _{GS} = 0V, V _{DS} = 10V
Q _{gs}	Gate-to-Source Charge	—	8.1	—		
Q _{gd}	Gate-to-Drain ("Miller") Charge	—	6.4	—		
Q _{OSS}	Output Gate Charge	—	16	24		
R _G	Gate Resistance	0.3	—	3.2	Ω	
t _{d(on)}	Turn-On Delay Time	—	8.4	—	ns	V _{DD} = 10V I _D = 28.4A R _G = 1.8Ω V _{GS} = 4.5V ③
t _r	Rise Time	—	98	—		
t _{d(off)}	Turn-Off Delay Time	—	12	—		
t _f	Fall Time	—	5.0	—		
C _{iss}	Input Capacitance	—	1996	—	pF	V _{GS} = 0V V _{DS} = 10V f = 1.0MHz
C _{OSS}	Output Capacitance	—	1085	—		
C _{rss}	Reverse Transfer Capacitance	—	155	—		

Avalanche Characteristics

Symbol	Parameter	Typ	Max	Units
E _{AS}	Single Pulse Avalanche Energy ②	—	216	mJ
I _{AR}	Avalanche Current ①	—	71	A

Diode Characteristics

Symbol	Parameter	Min	Typ	Max	Units	Conditions
I _S	Continuous Source Current (Body Diode)	—	—	75 ④	A	MOSFET symbol showing the integral reverse p-n junction diode.
I _{SM}	Pulsed Source Current (Body Diode) ①	—	—	300		
V _{SD}	Diode Forward Voltage	—	0.88	1.3	V	T _J = 25°C, I _S = 35.5A, V _{GS} = 0V ③ T _J = 125°C, I _S = 35.5A, V _{GS} = 0V ③
t _{rr}	Reverse Recovery Time	—	38	57	ns	T _J = 25°C, I _F = 35.5A, V _R = 20V
Q _{rr}	Reverse Recovery Charge	—	45	68	nC	di/dt = 100A/μs ③
t _{rr}	Reverse Recovery Time	—	41	62	ns	T _J = 125°C, I _F = 35.5A, V _R = 20V
Q _{rr}	Reverse Recovery Charge	—	50	75	nC	di/dt = 100A/μs ③

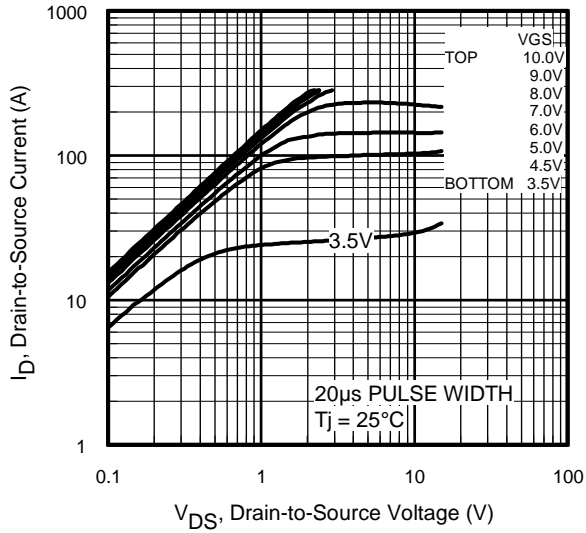

Fig 1. Typical Output Characteristics

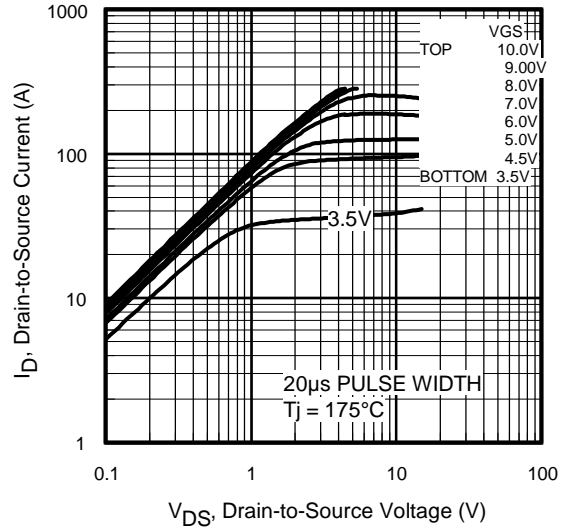

Fig 2. Typical Output Characteristics

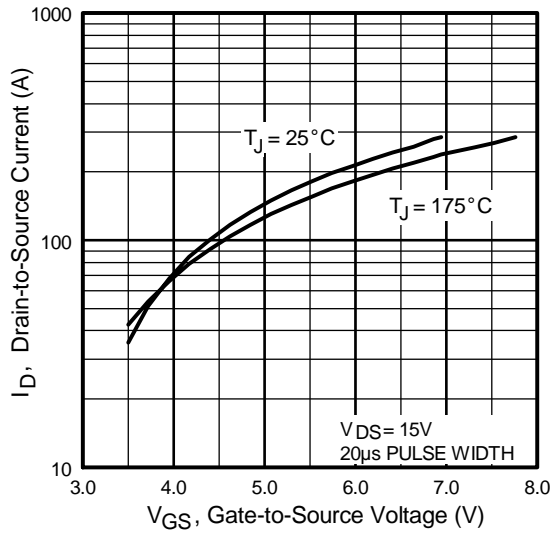

Fig 3. Typical Transfer Characteristics

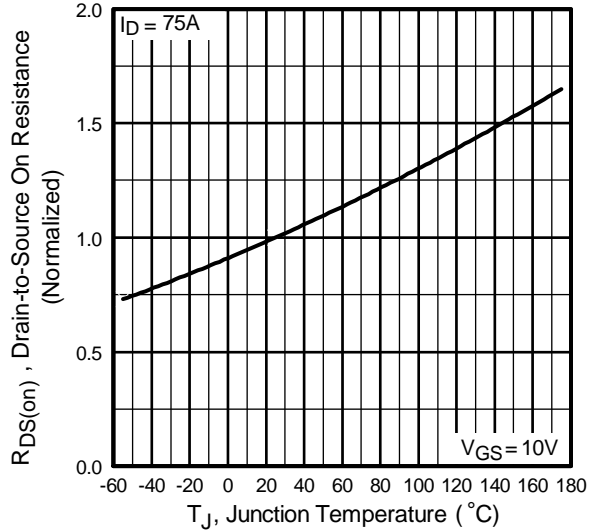

Fig 4. Normalized On-Resistance Vs. Temperature

IRFR/U3704PbF

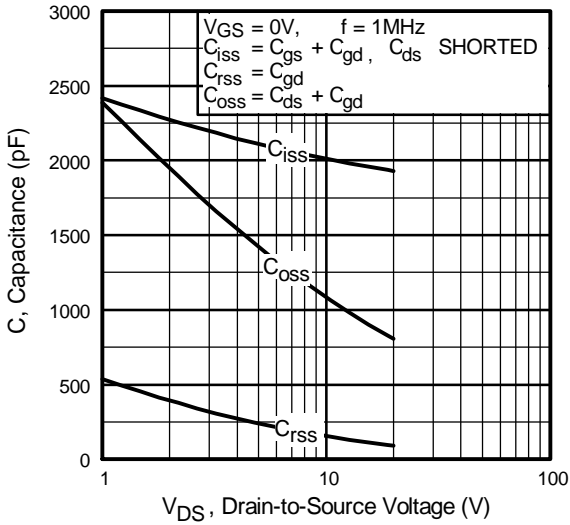

Fig 5. Typical Capacitance Vs. Drain-to-Source Voltage

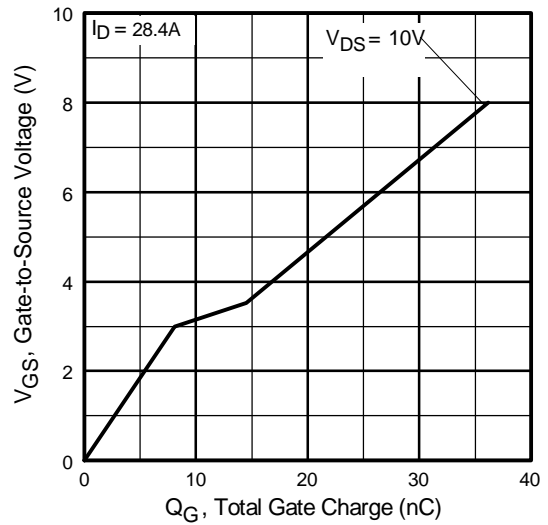

Fig 6. Typical Gate Charge Vs. Gate-to-Source Voltage

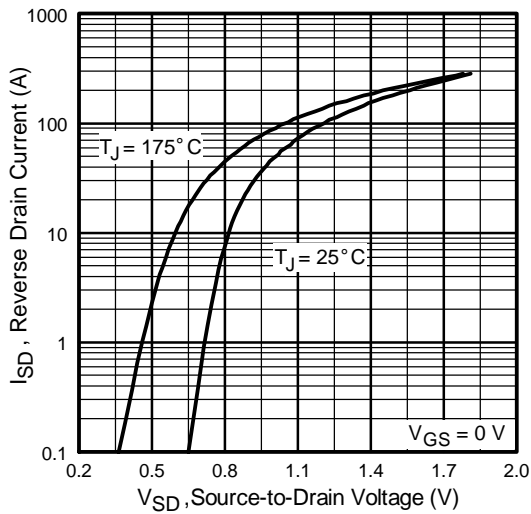

Fig 7. Typical Source-Drain Diode Forward Voltage

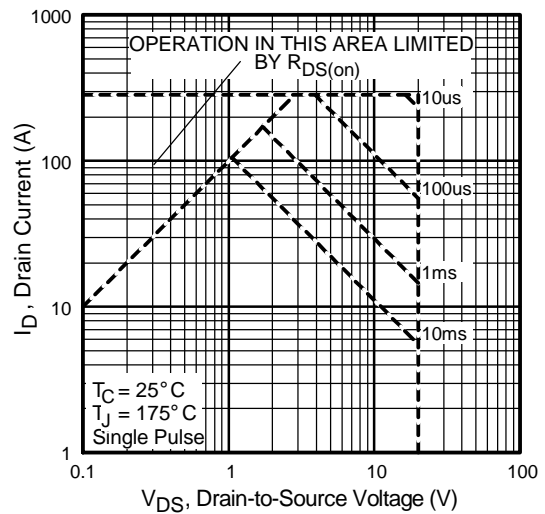

Fig 8. Maximum Safe Operating Area

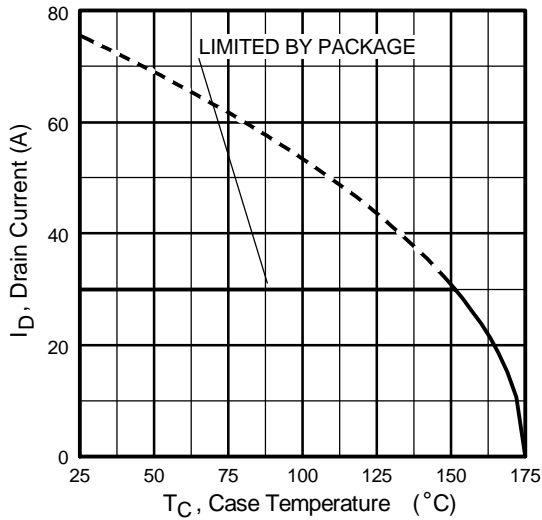

Fig 9. Maximum Drain Current Vs. Case Temperature

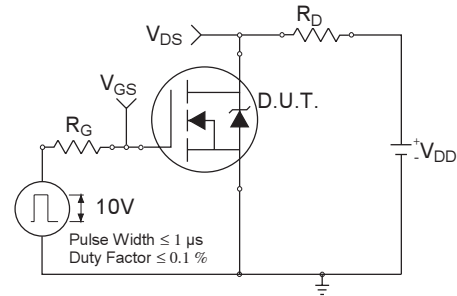

Fig 10a. Switching Time Test Circuit

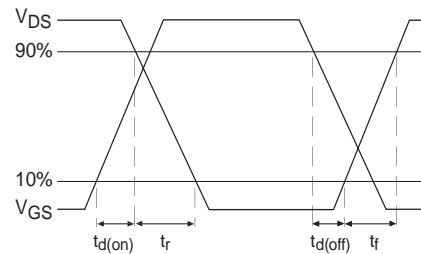

Fig 10b. Switching Time Waveforms

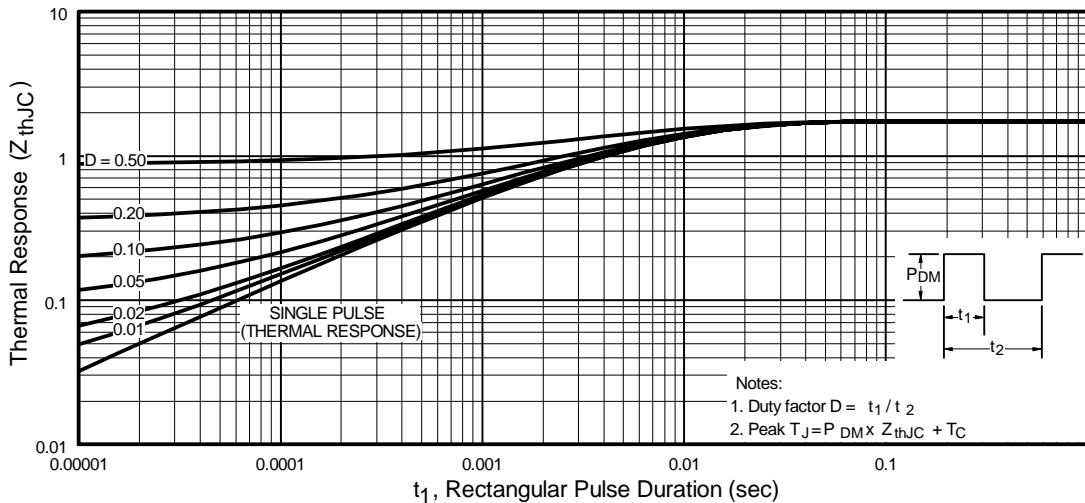

Fig 11. Maximum Effective Transient Thermal Impedance, Junction-to-Ambient

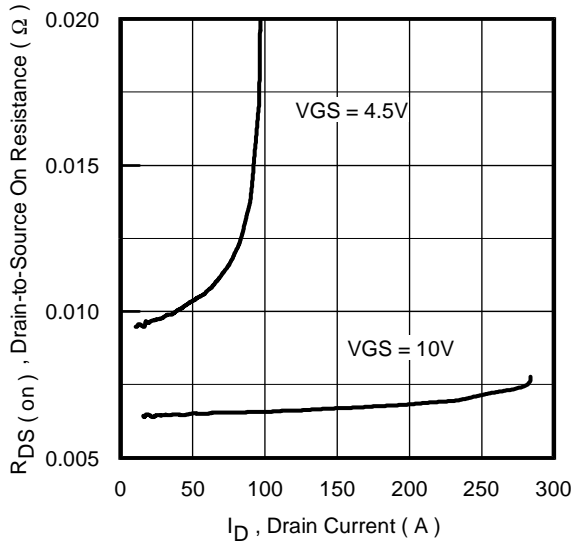

Fig 12. On-Resistance Vs. Drain Current

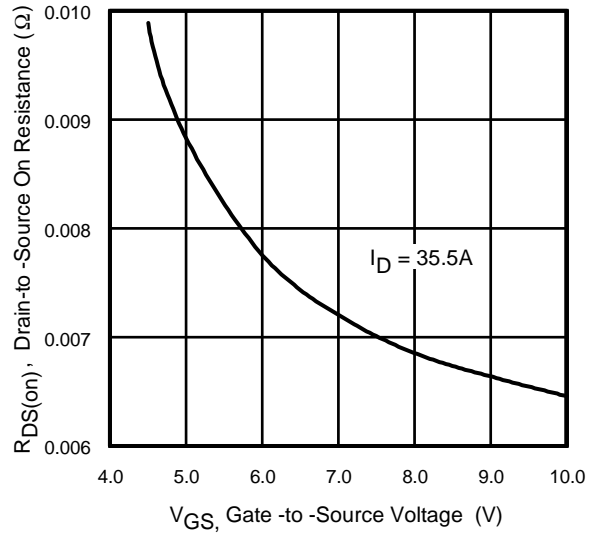

Fig 13. On-Resistance Vs. Gate Voltage

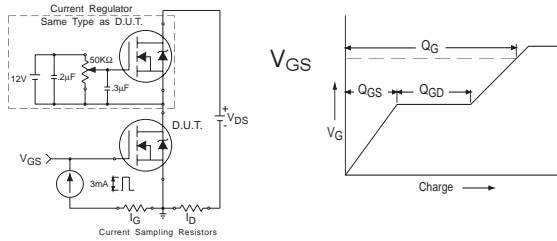

Fig 14a&b. Basic Gate Charge Test Circuit and Waveforms

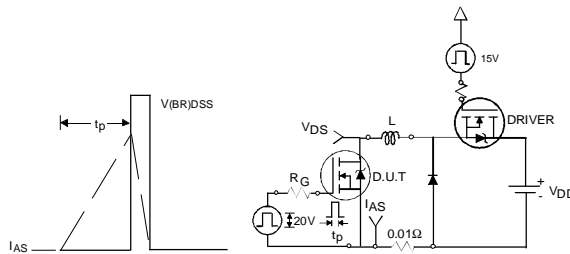

Fig 15a&b. Unclamped Inductive Test Circuit and Waveforms

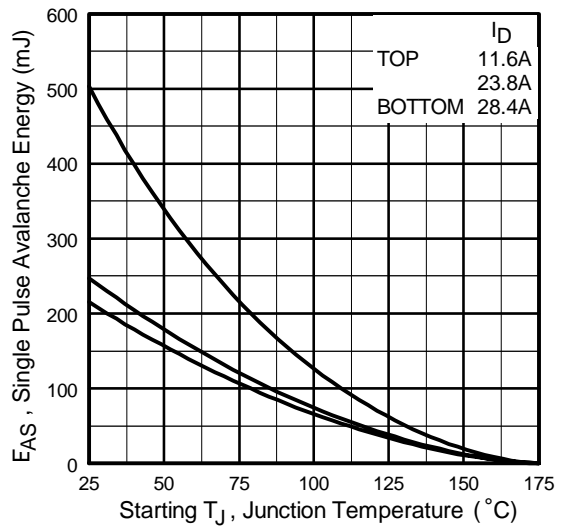
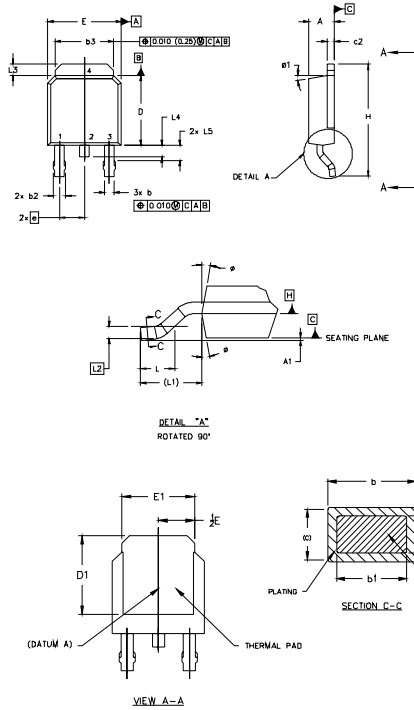

Fig 15c. Maximum Avalanche Energy Vs. Drain Current

D-Pak (TO-252AA) Package Outline

Dimensions are shown in millimeters (inches)



NOTES:

- 1.0 DIMENSIONING AND TOLERANCING PER ASME Y14.5 M- 1994.
- 2.0 DIMENSIONS ARE SHOWN IN INCHES (MILLIMETERS).
- 3.0 LEAD DIMENSION UNCONTROLLED IN L5
- 4.0 DIMENSION D1 AND E1 ESTABLISH A MINIMUM MOUNTING SURFACE FOR THERMAL PAD.
- 5.0 SECTION C-C DIMENSIONS APPLY TO THE FLAT SECTION OF THE LEAD BETWEEN .005 [0.127] AND .010 [0.2540] FROM THE LEAD TIP.
- 6.0 DIMENSION D & E DO NOT INCLUDE MOLD FLASH. MOLD FLASH SHALL NOT EXCEED .005" (0.127) PER SIDE. THESE DIMENSIONS ARE MEASURED AT THE OUTERMOST EXTREMES OF THE PLASTIC BODY.
- 7.0 OUTLINE CONFORMS TO JEDEC OUTLINE: TO-252AA.

SYMBOL	MILLIMETERS		INCHES		NOTES
	MIN.	MAX.	MIN.	MAX.	
A	2.18	2.39	.086	.094	
A1		0.13		.005	
b	0.64	0.89	.025	.035	5
b1	0.64	0.79	.025	0.031	5
b2	0.76	1.14	.030	.045	
b3	4.95	5.46	.195	.215	
c	0.46	0.61	.018	.024	5
c1	0.41	0.56	.016	.022	5
c2	.046	0.89	.018	.035	5
D	5.97	6.22	.235	.245	6
D1	5.21	-	.205	-	4
E	6.35	6.75	.250	.265	6
E1	4.32	-	.170	-	4
e	2.29	-	.090	BSC	
H	9.40	10.41	.370	.410	
L	1.40	1.78	.055	.070	
L1	2.74	REF.	.108	REF.	
L2	0.051	BSC	.020	BSC	
L3	0.89	1.27	.035	.050	
L4		1.02		.040	
L5	1.14	1.52	.045	.060	
#	0"	10"	0"	10"	5
#1	0"	15"	0"	15"	

LEAD ASSIGNMENTS

HEXFET

- 1.- GATE
- 2.- DRAIN
- 3.- SOURCE
- 4.- DRAIN

IGBTs, CoPACK

- 1.- GATE
- 2.- COLLECTOR
- 3.- EMITTER
- 4.- COLLECTOR

D-Pak (TO-252AA) Part Marking Information

EXAMPLE: THIS IS AN IRFR120
WITH ASSEMBLY
LOT CODE 1234
ASSEMBLED ON WW 16, 1999
IN THE ASSEMBLY LINE "A"

Note: "P" in assembly line position
indicates "Lead-Free"

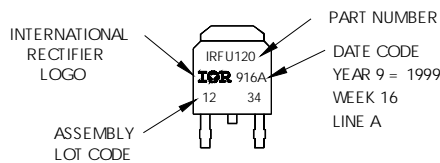

OR

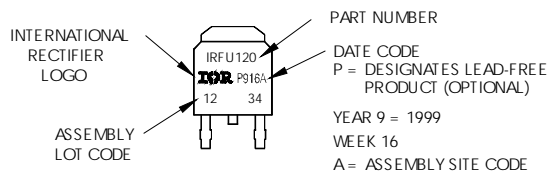

IRFR/U3704PbF

International
IR Rectifier

I-Pak (TO-251AA) Package Outline

Dimensions are shown in millimeters (inches)

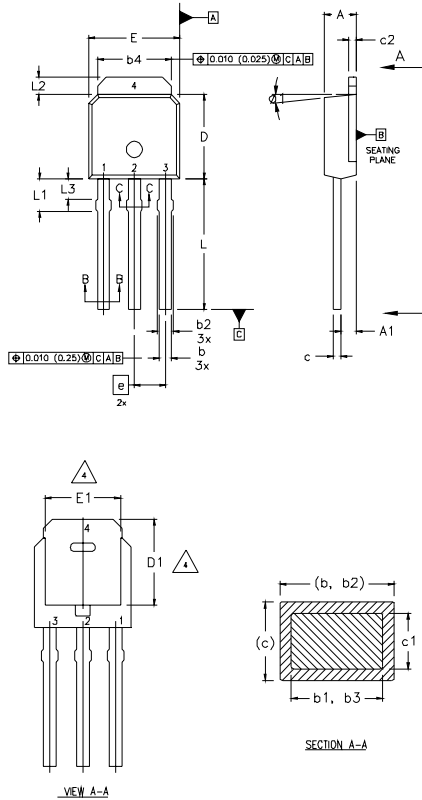

NOTES:

- 1 DIMENSIONING AND TOLERANCING PER ASME Y14.5 M- 1994.
- 2 DIMENSIONS ARE SHOWN IN MILLIMETERS (INCHES).
- 3 DIMENSION D & E DO NOT INCLUDE MOLD FLASH. MOLD FLASH SHALL NOT EXCEED 0.005" (0.127) PER SIDE. THESE DIMENSIONS ARE MEASURED AT THE OUTERMOST EXTREMES OF THE PLASTIC BODY.
- 4 THERMAL PAD CONTOUR OPTION WITHIN DIMENSION b4, L2, E1 & D1.
- 5 LEAD DIMENSION UNCONTROLLED IN L3.
- 6 DIMENSION b1, b3 APPLY TO BASE METAL ONLY.
- 7 OUTLINE CONFORMS TO JEDEC OUTLINE TO-251AA.
- 8 CONTROLLING DIMENSION : INCHES.

LEAD ASSIGNMENTS

HEXFEEET

- 1.- GATE
- 2.- DRAIN
- 3.- SOURCE
- 4.- DRAIN

SYMBOL	DIMENSIONS				NOTES
	MILLIMETERS		INCHES		
	MIN.	MAX.	MIN.	MAX.	
A	2.18	2.39	0.086	.094	
A1	0.89	1.14	0.035	0.045	
b	0.64	0.89	0.025	0.035	
b1	0.64	0.79	0.025	0.031	4
b2	0.76	1.14	0.030	0.045	
b3	0.76	1.04	0.030	0.041	
b4	5.00	5.46	0.195	0.215	4
c	0.46	0.61	0.018	0.024	
c1	0.41	0.56	0.016	0.022	
c2	.046	0.86	0.018	0.035	
D	5.97	6.22	0.235	0.245	3, 4
D1	5.21	-	0.205	-	4
E	6.35	6.73	0.250	0.265	3, 4
E1	4.32	-	0.170	-	4
e	2.29		0.090 BSC		
L	8.89	9.60	0.350	0.380	
L1	1.91	2.29	0.075	0.090	
L2	0.89	1.27	0.035	0.050	4
L3	1.14	1.52	0.045	0.060	5
ø1	Ø	15°	Ø	15°	

I-Pak (TO-251AA) Part Marking Information

EXAMPLE: THIS IS AN IRFU120 WITH ASSEMBLY LOT CODE 5678 ASSEMBLED ON WW 19, 1999 IN THE ASSEMBLY LINE "A"
Note: "P" in assembly line position indicates "Lead-Free"

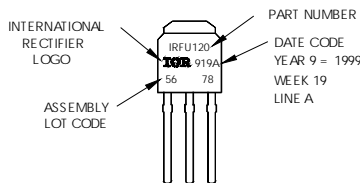

OR

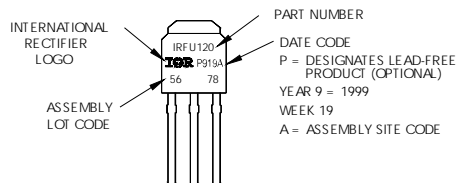

D-Pak (TO-252AA) Tape & Reel Information

Dimensions are shown in millimeters (inches)

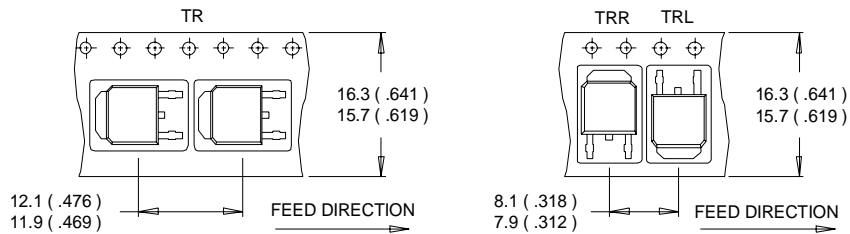

- NOTES :
1. CONTROLLING DIMENSION : MILLIMETER.
 2. ALL DIMENSIONS ARE SHOWN IN MILLIMETERS (INCHES).
 3. OUTLINE CONFORMS TO EIA-481 & EIA-541.

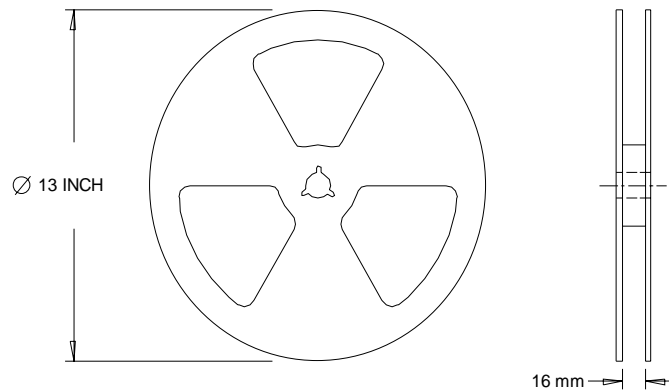

- NOTES :
1. OUTLINE CONFORMS TO EIA-481.

Notes:

- ① Repetitive rating; pulse width limited by max. junction temperature.
- ② Starting $T_J = 25^\circ\text{C}$, $L = 0.5 \text{ mH}$
 $R_G = 25\Omega$, $I_{AS} = 28.4 \text{ A}$.
- ③ Pulse width $\leq 300\mu\text{s}$; duty cycle $\leq 2\%$.
- ④ Calculated continuous current based on maximum allowable junction temperature. Package limitation current is 30A
- ⑤ R_θ is measured at T_J approximately 90°C

Data and specifications subject to change without notice.
 This product has been designed and qualified for the Industrial market.
 Qualification Standards can be found on IR's Web site.

Note: For the most current drawings please refer to the IR website at:
<http://www.irf.com/package/>

Looking for pricing, stock, or lifecycle information?

Click below to explore more details on WIN SOURCE:

-  [View IRFU3704PBF on WIN SOURCE](#)
-  [Infineon Technologies](#) Information

Optimize Your Supply Chain with WIN SOURCE Solutions

-  Global Sourcing Solution
-  Obsolete Management
-  Cost Control Management
-  Shortage Management
-  Alternative Solution
-  Excess Inventory Management