



**THE DATASHEET OF
LQP02TN9N1H02D**



Customer Part Number	MURATA Part Number	Inductance		Q (min)	DC Resistance (Ω max)	Self Resonant Frequency (MHz min)		Rated Current (mA)
		(nH)	Tolerance			Min.	*Typ.	
	LQP02TN1N1B02D	1.1	B: ± 0.1 nH C: ± 0.2 nH	8	0.60	12500	15300	220
	LQP02TN1N1B02L							
	LQP02TN1N1C02D							
	LQP02TN1N1C02L							
	LQP02TN1N2B02D							
	LQP02TN1N2B02L							
	LQP02TN1N2C02D							
	LQP02TN1N2C02L							
	LQP02TN1N3B02D							
	LQP02TN1N3B02L							
	LQP02TN1N3C02D							
	LQP02TN1N3C02L							
	LQP02TN1N4B02D							
	LQP02TN1N4B02L							
	LQP02TN1N4C02D							
	LQP02TN1N4C02L							
	LQP02TN1N5B02D							
	LQP02TN1N5B02L							
	LQP02TN1N5C02D							
	LQP02TN1N5C02L							
	LQP02TN1N6B02D							
	LQP02TN1N6B02L							
	LQP02TN1N6C02D							
	LQP02TN1N6C02L							
	LQP02TN1N7B02D							
	LQP02TN1N7B02L							
	LQP02TN1N7C02D							
	LQP02TN1N7C02L							
	LQP02TN1N8B02D							
	LQP02TN1N8B02L							
	LQP02TN1N8C02D							
	LQP02TN1N8C02L							
	LQP02TN1N9B02D							
	LQP02TN1N9B02L							
	LQP02TN1N9C02D							
	LQP02TN1N9C02L							
	LQP02TN2N0B02D							
	LQP02TN2N0B02L							
	LQP02TN2N0C02D							
	LQP02TN2N0C02L							
	LQP02TN2N1B02D							
	LQP02TN2N1B02L							
	LQP02TN2N1C02D							
	LQP02TN2N1C02L							
	LQP02TN2N2B02D							
	LQP02TN2N2B02L							
	LQP02TN2N2C02D							
	LQP02TN2N2C02L							
	LQP02TN2N3B02D							
	LQP02TN2N3B02L							
	LQP02TN2N3C02D							
	LQP02TN2N3C02L							

Customer Part Number	MURATA Part Number	Inductance		Q (min)	DC Resistance (Ω max)	Self Resonant Frequency (MHz)		Rated Current (mA)
		(nH)	Tolerance			Min.	*Typ.	
	LQP02TN2N4B02D	2.4	B: ± 0.1 nH C: ± 0.2 nH	8	0.75	7500	9500	200
	LQP02TN2N4B02L							
	LQP02TN2N4C02D							
	LQP02TN2N4C02L							
	LQP02TN2N5B02D							
	LQP02TN2N5B02L							
	LQP02TN2N5C02D	2.5						
	LQP02TN2N5C02L							
	LQP02TN2N6B02D	2.6						
	LQP02TN2N6B02L							
	LQP02TN2N6C02D							
	LQP02TN2N6C02L	2.7						
	LQP02TN2N7B02D							
	LQP02TN2N7B02L							
	LQP02TN2N7C02D	2.8						
	LQP02TN2N7C02L							
	LQP02TN2N8B02D							
	LQP02TN2N8B02L	2.9						
	LQP02TN2N8C02D							
	LQP02TN2N8C02L							
	LQP02TN2N9B02D	3.0						
	LQP02TN2N9B02L							
	LQP02TN2N9C02D							
	LQP02TN2N9C02L	3.1						
	LQP02TN3N0B02D							
	LQP02TN3N0B02L							
	LQP02TN3N0C02D	3.2						
	LQP02TN3N0C02L							
	LQP02TN3N1B02D							
	LQP02TN3N1B02L	3.3						
	LQP02TN3N1C02D							
	LQP02TN3N1C02L							
	LQP02TN3N2B02D	3.4						
	LQP02TN3N2B02L							
	LQP02TN3N2C02D							
	LQP02TN3N2C02L	3.5						
	LQP02TN3N3B02D							
	LQP02TN3N3B02L							
	LQP02TN3N3C02D	3.6						
	LQP02TN3N3C02L							
	LQP02TN3N4B02D							
	LQP02TN3N4B02L	10200						
	LQP02TN3N4C02D							
	LQP02TN3N4C02L							
	LQP02TN3N5B02D	10100						
	LQP02TN3N5B02L							
	LQP02TN3N5C02D							
	LQP02TN3N5C02L	180						
	LQP02TN3N6B02D							
	LQP02TN3N6B02L							
	LQP02TN3N6C02D	180						
	LQP02TN3N6C02L							

Customer Part Number	MURATA Part Number	Inductance		Q (min)	DC Resistance (Ω max)	Self Resonant Frequency (MHz)		Rated Current (mA)
		(nH)	Tolerance			Min.	*Typ.	
	LQP02TN3N7B02D	3.7	B: ± 0.1 nH C: ± 0.2 nH	8	1.30	7500	10300	180
	LQP02TN3N7B02L							
	LQP02TN3N7C02D							
	LQP02TN3N7C02L							
	LQP02TN3N8B02D	3.8						
	LQP02TN3N8B02L							
	LQP02TN3N8C02D							
	LQP02TN3N8C02L							
	LQP02TN3N9B02D	3.9						
	LQP02TN3N9B02L							
	LQP02TN3N9C02D							
	LQP02TN3N9C02L							
	LQP02TN4N0B02D	4.0						
	LQP02TN4N0B02L							
	LQP02TN4N0C02D							
	LQP02TN4N0C02L							
	LQP02TN4N1B02D	4.1						
	LQP02TN4N1B02L							
	LQP02TN4N1C02D							
	LQP02TN4N1C02L							
	LQP02TN4N2B02D	4.2						
	LQP02TN4N2B02L							
	LQP02TN4N2C02D							
	LQP02TN4N2C02L							
	LQP02TN4N3H02D	4.3						
	LQP02TN4N3H02L							
	LQP02TN4N3J02D							
	LQP02TN4N3J02L							
	LQP02TN4N7H02D	4.7						
	LQP02TN4N7H02L							
	LQP02TN4N7J02D							
	LQP02TN4N7J02L							
	LQP02TN5N1H02D	5.1						
	LQP02TN5N1H02L							
	LQP02TN5N1J02D							
	LQP02TN5N1J02L							
	LQP02TN5N6H02D	5.6						
	LQP02TN5N6H02L							
	LQP02TN5N6J02D							
	LQP02TN5N6J02L							
	LQP02TN6N2H02D	6.2						
	LQP02TN6N2H02L							
	LQP02TN6N2J02D							
	LQP02TN6N2J02L							
	LQP02TN6N8H02D	6.8						
	LQP02TN6N8H02L							
	LQP02TN6N8J02D							
	LQP02TN6N8J02L							
	LQP02TN7N5H02D	7.5						
	LQP02TN7N5H02L							
	LQP02TN7N5J02D							
	LQP02TN7N5J02L							

Customer Part Number	MURATA Part Number	Inductance		Q (min)	DC Resistance (Ω max)	Self Resonant Frequency (MHz)		Rated Current (mA)
		(nH)	Tolerance			Min.	*Typ.	
	LQP02TN8N2H02D	8.2		8	2.10	4500	6200	140
	LQP02TN8N2H02L							
	LQP02TN8N2J02D							
	LQP02TN8N2J02L							
	LQP02TN9N1H02D	9.1		8	2.10	4000	5600	140
	LQP02TN9N1H02L							
	LQP02TN9N1J02D							
	LQP02TN9N1J02L							
	LQP02TN10NH02D	10		7	2.50	3000	5300	140
	LQP02TN10NH02L							
	LQP02TN10NJ02D							
	LQP02TN10NJ02L							
	LQP02TN11NH02D	11		7	2.80	3500	4400	140
	LQP02TN11NH02L							
	LQP02TN11NJ02D							
	LQP02TN11NJ02L							
	LQP02TN12NH02D	12		7	3.20	3000	4200	140
	LQP02TN12NH02L							
	LQP02TN12NJ02D							
	LQP02TN12NJ02L							
	LQP02TN13NH02D	13		7	3.50	2500	3600	140
	LQP02TN13NH02L							
	LQP02TN13NJ02D							
	LQP02TN13NJ02L							
	LQP02TN15NH02D	15	H: $\pm 3\%$ J: $\pm 5\%$	6	5.00	2300	3100	120
	LQP02TN15NH02L							
	LQP02TN15NJ02D							
	LQP02TN15NJ02L							
	LQP02TN16NH02D	16		6	5.50	2000	2800	120
	LQP02TN16NH02L							
	LQP02TN16NJ02D							
	LQP02TN16NJ02L							
	LQP02TN18NH02D	18		6	5.50	2000	2500	120
	LQP02TN18NH02L							
	LQP02TN18NJ02D							
	LQP02TN18NJ02L							
	LQP02TN20NH02D	20		6	5.00	2300	3100	120
	LQP02TN20NH02L							
	LQP02TN20NJ02D							
	LQP02TN20NJ02L							
	LQP02TN22NH02D	22		6	5.00	2300	3000	120
	LQP02TN22NH02L							
	LQP02TN22NJ02D							
	LQP02TN22NJ02L							
	LQP02TN24NH02D	24		6	5.50	2000	2800	120
	LQP02TN24NH02L							
	LQP02TN24NJ02D							
	LQP02TN24NJ02L							
	LQP02TN27NH02D	27		6	5.50	2000	2500	120
	LQP02TN27NH02L							
	LQP02TN27NJ02D							
	LQP02TN27NJ02L							

Customer Part Number	MURATA Part Number	Inductance		Q (min)	DC Resistance (Ω max)	Self Resonant Frequency (MHz)		Rated Current (mA)
		(nH)	Tolerance			Min.	*Typ	
	LQP02TN30NH02D	30	H: $\pm 3\%$ J: $\pm 5\%$	6	6.50	1800	2600	90
	LQP02TN30NH02L							
	LQP02TN30NJ02D							
	LQP02TN30NJ02L							
	LQP02TN33NH02D	33		4	7.00	1600	2300	
	LQP02TN33NH02L							
	LQP02TN33NJ02D							
	LQP02TN33NJ02L							
	LQP02TN36NH02D	36	4	7.00	1600	2100		
	LQP02TN36NH02L							
	LQP02TN36NJ02D							
	LQP02TN36NJ02L							
	LQP02TN39NH02D	39	4	7.00	1600	2100		
	LQP02TN39NH02L							
	LQP02TN39NJ02D							
	LQP02TN39NJ02L							

* Typical value is actual performance.

4. Testing Conditions

《Unless otherwise specified》

Temperature : Ordinary Temperature / 15°C to 35°C

Humidity : Ordinary Humidity / 25%(RH) to 85 %(RH)

《In case of doubt》

Temperature : 20°C \pm 2°C

Humidity : 60%(RH) to 70 %(RH)

Atmospheric Pressure : 86kPa to 106 kPa

5. Appearance and Dimensions

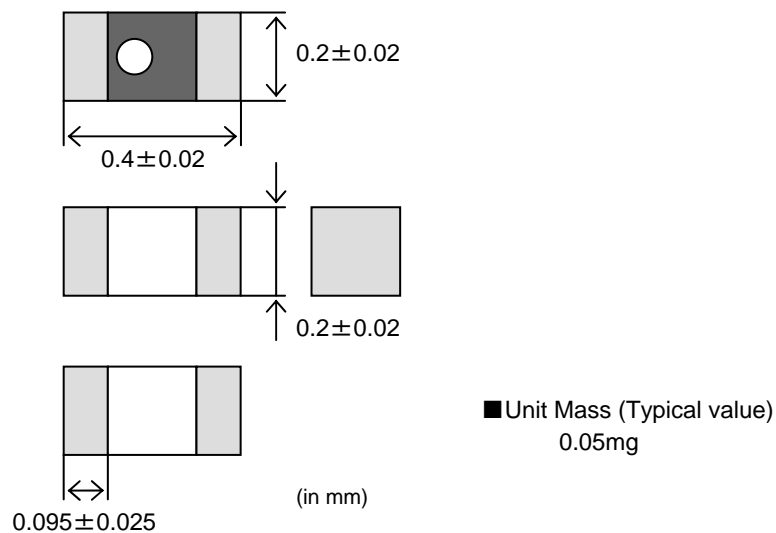

6. Marking

Polarity Marking :white

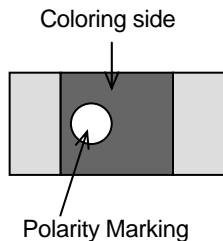

7. Electrical Performance

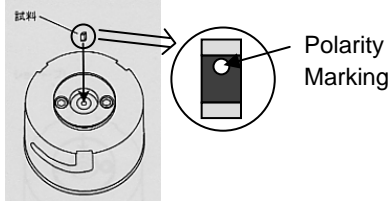
No.	Item	Specification	Test Method
7.1	Inductance	Inductance shall meet item 3.	Measuring Equipment: KEYSIGHT E4991A or equivalent Measuring Frequency: (0.2nH~30nH) 500MHz (33nH~39nH) 300MHz Measuring Condition: Test signal level / about 0dBm Electrical length / 27.3mm Weight / about 3N Measuring Fixture: KEYSIGHT 16196D Insert Chip coil in the hole in order that the polarity marking is at the top of the side surface. Contact coil with each terminal by adding the weigh cover. See diagram below.
7.2	Q	Q shall meet item 3.	 Chip coil placement hole: ϕ 0.3mm Measuring Method: See P.14 <Electrical Performance: Measuring Method of Inductance/Q>
7.3	DC Resistance	DC Resistance shall meet item 3.	Measuring Equipment: Digital multi meter
7.4	Self Resonant Frequency(S.R.F)	S.R.F shall meet item 3.	Measuring Equipment: KEYSIGHT 8753C or equivalent
7.5	Rated Current	Self temperature rise shall be limited to 25°C max.	The rated current is applied.

8. Mechanical Performance

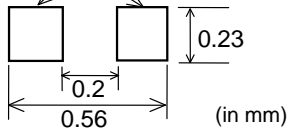
No.	Item	Specification	Test Method
8.1	Shear Test	Chip coil shall not be damaged after tested as test method.	Substrate: Glass-epoxy substrate Land  Force: 1N Hold Duration: 5 s ± 1 s Applied Direction: Parallel to PCB.

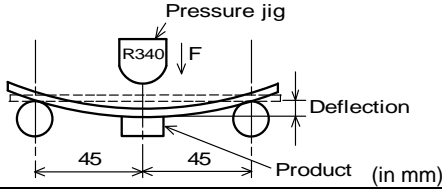
No.	Item	Specification	Test Method
8.2	Bending Test	Chip coil shall not be damaged after tested as test method.	Substrate:Glass-epoxy substrate (100mm × 40mm × 0.8mm) Speed of Applying Force:1mm /s Deflection:1mm Hold Duration:30 s 
8.3	Vibration	Appearance:No damage	Substrate:Glass-epoxy substrate Oscillation Frequency: 10Hz to 2000Hz to 10Hz for 20 min Total amplitude 1.5 mm or Acceleration amplitude 196 m/s ² whichever is smaller. Testing Time:A period of 2h in each of 3 mutually perpendicular directions.
8.4	Solderability	The electrode shall be at least 90% covered with new solder coating.	Flux: Ethanol solution of rosin 25(wt)% (Immersed for 5s to 10s) Solder:Sn-3.0Ag-0.5Cu Pre-Heating:150°C±10°C / 60s to 90s Solder Temperature:240°C±5°C Immersion Time:3s±1s
8.5	Resistance to Soldering Heat	Appearance:No damage Inductance Change: within ±10%	Flux: Ethanol solution of rosin 25(wt)% (Immersed for 5s to 10s) Solder:Sn-3.0Ag-0.5Cu Pre-Heating:150°C±10°C / 60s to 90s Solder Temperature:260°C±5°C Immersion Time:5s±1s Then measured after exposure in the room condition for 24h±2h.

9.Environmental Performance

It shall be soldered on the substrate.

No.	Item	Specification	Test Method
9.1	Heat Resistance	Appearance:No damage Inductance Change: within ±10%	Substrate:Glass-epoxy substrate Temperature:125°C±2°C Time:1000h (+48h,-0h) Then measured after exposure in the room condition for 24h±2h.
9.2	Cold Resistance		Substrate:Glass-epoxy substrate Temperature:-55°C±3°C Time:1000 h (+48h,-0h) Then measured after exposure in the room condition for 24h±2h.
9.3	Humidity		Substrate:Glass-epoxy substrate Temperature:40°C±2°C Humidity:90%(RH) to 95%(RH) Time:1000 h(+48h,-0h) Then measured after exposure in the room condition for 24h±2h.
9.4	Temperature Cycle		Substrate:Glass-epoxy substrate 1 cycle: 1 step:-55°C±2°C / 30min±3 min 2 step:Ordinary temp. / 10~15 min 3 step:125°C±2°C / 30±3 min 4 step: Ordinary temp. / 10~15 min Total of 10 cycles Then measured after exposure in the room condition for 24h±2h.

10. Specification of Packaging

10.1 Appearance and Dimensions of paper tape

【8mm-wide / paper tape】

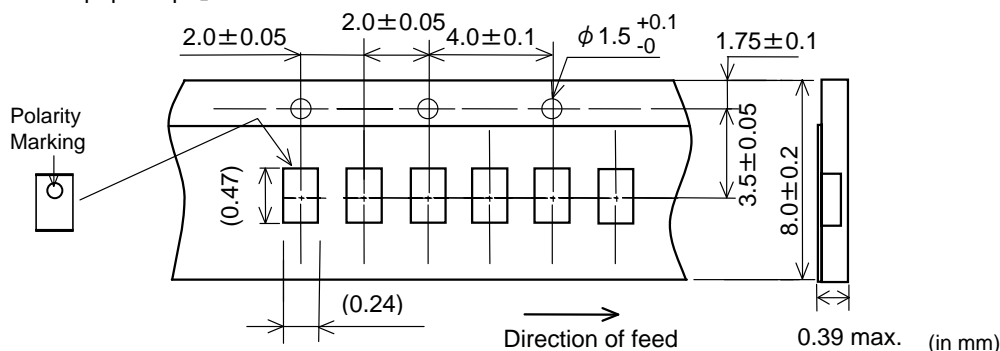

【4mm-wide / plastic tape】

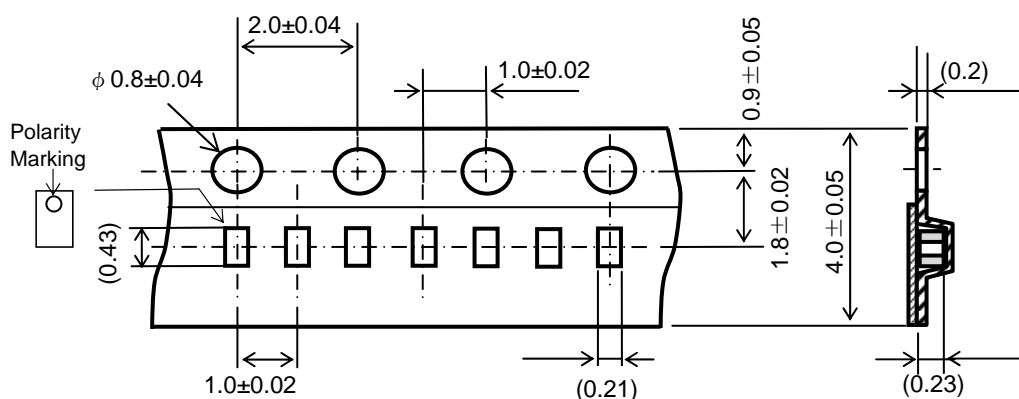

Dimension of the Cavity is measured at the bottom side.

10.2 Specification of Taping

【8mm-wide / paper tape】

- (1) Packing quantity (standard quantity)
20,000 pcs. / reel
- (2) Packing Method
Products shall be packed in the cavity of the base tape and sealed by cover tape.
- (3) Sprocket hole
The sprocket holes are to the right as the tape is pulled toward the user.
- (4) Spliced point
Base tape and Cover tape has no spliced point.
- (5) Missing components number
Missing components number within 0.1 % of the number per reel or 1 pc. , whichever is greater, and are not continuous. The Specified quantity per reel is kept.

【4mm-wide / plastic tape】

- (1) Packing quantity (standard quantity)
40,000 pcs. / reel
- (2) Packing Method
Products shall be packed in the each embossed cavity of plastic tape and sealed by cover tape.
- (3) Sprocket hole
Sprocket hole shall be located on the left-hand side toward the direction of feed.
- (4) Spliced point
Plastic tape and Cover tape has no spliced point.
- (5) Missing components number
Missing components number within 0.1 % of the number per reel or 1 pc. , whichever is greater, and are not continuous. The Specified quantity per reel is kept.

10.3 Pull Strength

Cover tape	5N min
------------	--------

10.4 Peeling off force of cover tape

Speed of Peeling off	300mm/min
Peeling off force	0.1N to 0.6N (minimum value is typical)

【8mm-wide / paper tape】

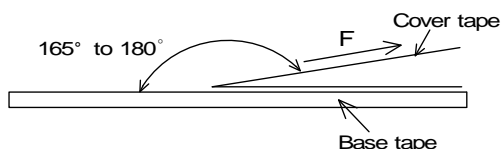

【4mm-wide / plastic tape】

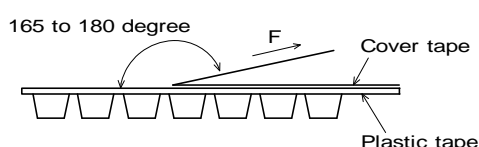

10.5 Dimensions of Leader-tape, Trailer and Reel

There shall be leader-tape (top tape and empty tape) and trailer-tape (empty tape) as follows.

【8mm-wide / paper tape】

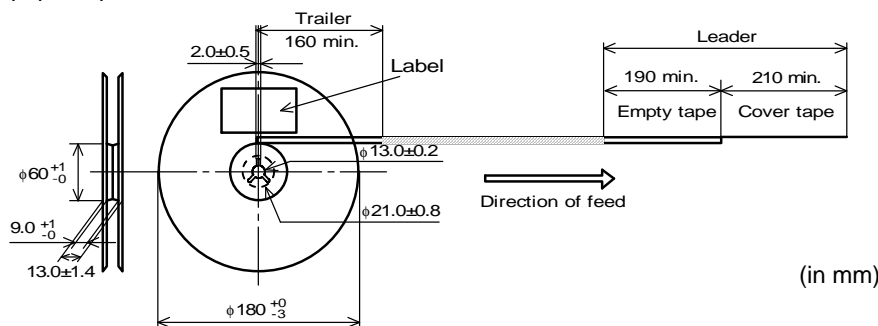

【4mm-wide / plastic tape】

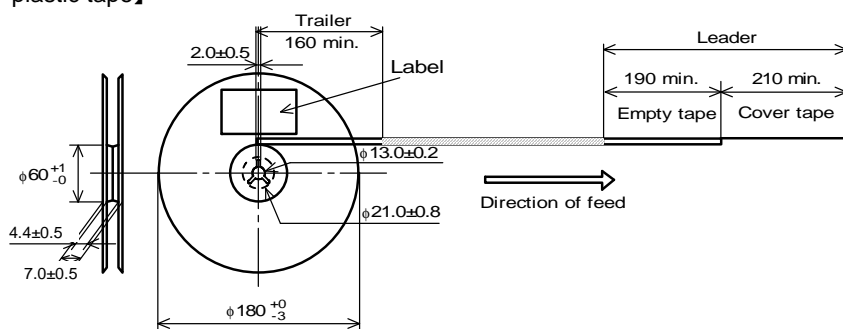

10.6 Marking for reel

Customer part number, MURATA part number, Inspection number(*1), RoHS Marking(*2), Quantity etc ...

*1) <Expression of Inspection No.>

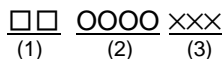

(1) Factory Code

(2) Date

First digit : Year / Last digit of year

Second digit : Month / Jan. to Sep. → 1 to 9, Oct. to Dec. → O,N,D

Third, Fourth digit : Day

(3) Serial No.

*2) <Expression of RoHS Marking >

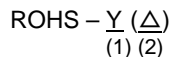

(1) RoHS regulation conformity parts.

(2) MURATA classification number

10.7 Marking for Outside package (corrugated paper box)

Customer name, Purchasing order number, Customer part number, MURATA part number, RoHS Marking (*2), Quantity, etc ...

10.8 Specification of Outer Case

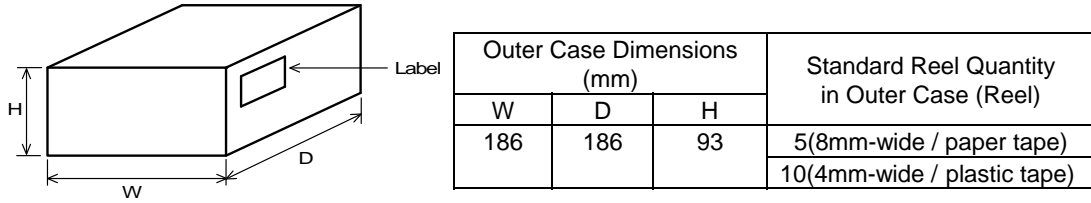

* Above Outer Case size is typical. It depends on a quantity of an order.

11. ⚠ Caution

Limitation of Applications

Please contact us before using our products for the applications listed below which require especially high reliability for the prevention of defects which might directly cause damage to the third party's life, body or property.

- | | |
|-----------------------------------|--|
| (1) Aircraft equipment | (6) Transportation equipment (vehicles, trains, ships, etc.) |
| (2) Aerospace equipment | (7) Traffic signal equipment |
| (3) Undersea equipment | (8) Disaster prevention / crime prevention equipment |
| (4) Power plant control equipment | (9) Data-processing equipment |
| (5) Medical equipment | (10) Applications of similar complexity and /or reliability requirements to the applications listed in the above |

12. Notice

Products can only be soldered with reflow.

This product is designed for solder mounting.

Please consult us in advance for applying other mounting method such as conductive adhesive.

12.1 Land pattern designing

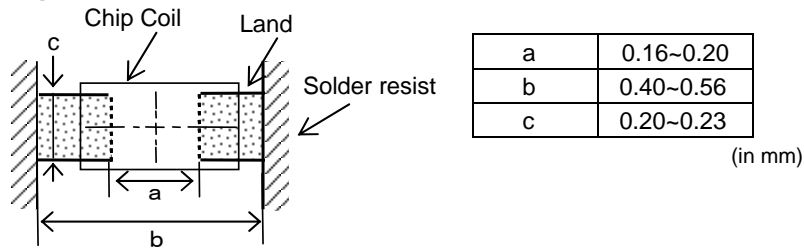

12.2 Flux, Solder

- Use rosin-based flux.
Don't use highly acidic flux with halide content exceeding 0.2(wt)% (chlorine conversion value).
Don't use water-soluble flux.
- Use Sn-3.0Ag-0.5Cu solder.
- Standard thickness of solder paste : 50 μm to 80 μm.

12.3 Reflow soldering conditions

- Pre-heating should be in such a way that the temperature difference between solder and product surface is limited to 150°C max. Cooling into solvent after soldering also should be in such a way that the temperature difference is limited to 100°C max.
Insufficient pre-heating may cause cracks on the product, resulting in the deterioration of products quality.
- Standard soldering profile and the limit soldering profile is as follows.
The excessive limit soldering conditions may cause leaching of the electrode and / or resulting in the deterioration of product quality.

• Reflow soldering profile

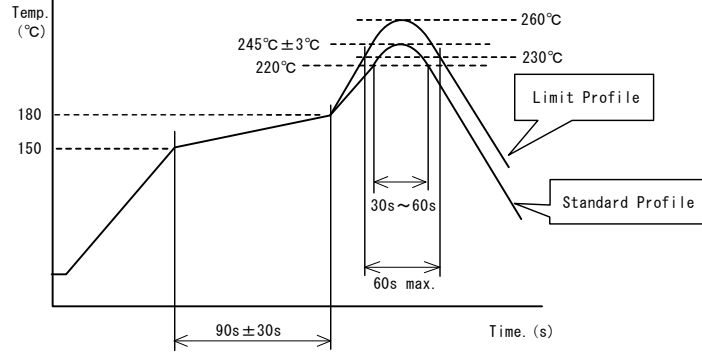

	Standard Profile	Limit Profile
Pre-heating	150°C ~ 180°C , 90s ± 30s	
Heating	above 220°C, 30s ~ 60s	above 230°C, 60s max.
Peak temperature	245°C ± 3°C	260°C, 10s
Cycle of reflow	2 times	2 times

12.4 Solder Volume

• Solder shall be used not to be exceeded the upper limits as shown below.

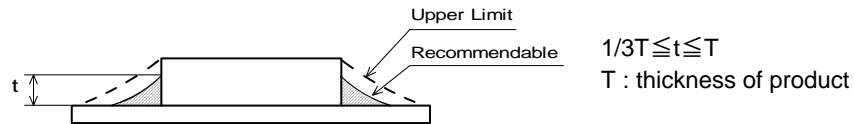

Accordingly increasing the solder volume, the mechanical stress to Chip is also increased. Exceeding solder volume may cause the failure of mechanical or electrical performance.

12.5 Attention regarding P.C.B. bending

The following shall be considered when designing and laying out P.C.B.'s.

(1) P.C.B. shall be designed so that products are not subject to the mechanical stress due to warping the board.

[Products direction]

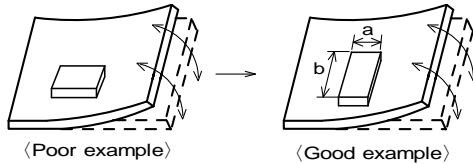

Products shall be located in the sideways direction (Length: $a < b$) to the mechanical stress.

(2) Products location on P.C.B. separation

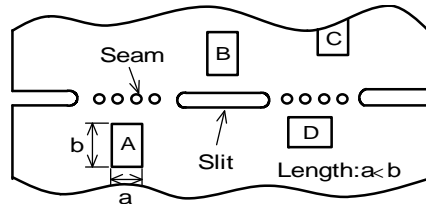

Products (A,B,C,D) shall be located carefully so that products are not subject to the mechanical stress due to warping the board. Because they may be subjected the mechanical stress in order of $A > C > B \cong D$.

12.6 Cleaning Conditions

Products shall be cleaned on the following conditions.

- (1) Cleaning temperature shall be limited to 60°C max.(40°C max for IPA)
- (2) Ultrasonic cleaning shall comply with the following conditions with avoiding the resonance phenomenon at the mounted products and P.C.B.
Power : 20 W / l max. Frequency : 28kHz to 40kHz Time : 5 min max.
- (3) Cleaner
 1. Alcohol type cleaner
Isopropyl alcohol (IPA)
 2. Aqueous agent
PINE ALPHA ST-100S
- (4) There shall be no residual flux and residual cleaner after cleaning.
In the case of using aqueous agent, products shall be dried completely after rinse with de-ionized water in order to remove the cleaner.
- (5) Other cleaning Please contact us.

12.7 Resin coating

When products are coated with resin, please contact us in advance.

12.8 Handling of a substrate

(1) There is a possibility of chip cracking caused by PCB expansion/contraction with heat, because stress on a chip is different depending on PCB material and structure.

When the thermal expansion coefficient greatly differs between the board used for mounting and the chip, it will cause cracking of the chip due to the thermal expansion and contraction.

The chip is assumed to be mounted on the PCB of glass-epoxy material, and we don't test with other PCB material which has different thermal expansion coefficient from Glass-epoxy.

When other PCB materials are considered, please be sure to evaluate by yourself..

(2) After mounting products on a substrate, do not apply any stress to the product caused by bending or twisting to the substrate when cropping the substrate, inserting and removing a connector from the substrate or tightening screw to the substrate.

Excessive mechanical stress may cause cracking in the product.

In case of the mounting on flexible PCB, there is a possibility of chip cracking caused by mechanical stress even from small bending or twisting.

When the flexible PCB is considered, please be sure to evaluate by yourself.

Bending

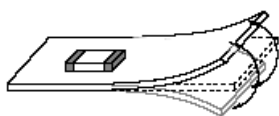

Twisting

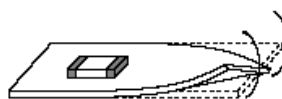
**12.9 Storage and Handling Requirements****(1) Storage period**

Use the products within 12 months after delivered.

Solderability should be checked if this period is exceeded.

(2) Storage conditions

• Products should be stored in the warehouse on the following conditions.

Temperature : -10°C ~ 40°C

Humidity : 15% to 85% relative humidity No rapid change on temperature and humidity.

• Products should not be stored on bulk packaging condition to prevent the chipping of the core and the breaking of winding wire caused by the collision between the products.

• Products should be stored on the palette for the prevention of the influence from humidity, dust and so on.

• Products should be stored in the warehouse without heat shock, vibration, direct sunlight and so on.

(3) Handling Condition

Care should be taken when transporting or handling product to avoid excessive vibration or mechanical shock.

13.▲ Note

- (1) Please make sure that your product has been evaluated in view of your specifications with our product being mounted to your product.
- (2) You are requested not to use our product deviating from the reference specifications.
- (3) The contents of this reference specification are subject to change without advance notice.
Please approve our product specifications or transact the approval sheet for product specifications before ordering.

<Electrical Performance: Measuring Method of Inductance/Q>

(1) Residual elements and stray elements of test fixture can be described by F-parameter shown in following.

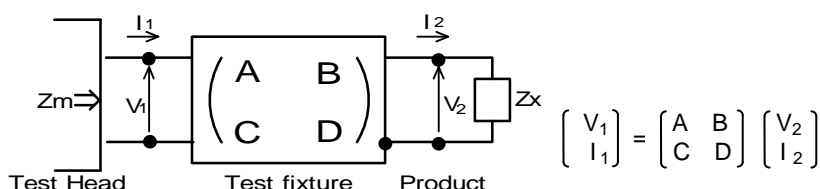

(2) The impedance of chip coil Z_x and measured value Z_m can be described by input/output current/voltage.

$$Z_m = \frac{V_1}{I_1} \quad , \quad Z_x = \frac{V_2}{I_2}$$

(3) Thus, the relation between Z_x and Z_m is following;

$$Z_x = \alpha \frac{Z_m - \beta}{1 - Z_m \Gamma} \quad \text{where, } \alpha = D / A = 1$$

$$\beta = B / D = Z_{sm} - (1 - Y_{om} Z_{sm}) Z_{ss}$$

$$\Gamma = C / A = Y_{om}$$

Z_{sm} : measured impedance of short chip
 Z_{ss} : residual impedance of short chip (0.110nH)
 Y_{om} : measured admittance when opening the fixture



(4) L_x and Q_x shall be calculated with the following equation.

$$L_x = \frac{\text{Im}(Z_x)}{2\pi f} \quad , \quad Q_x = \frac{\text{Im}(Z_x)}{\text{Re}(Z_x)}$$

L_x : Inductance of chip coil
 Q_x : Q of chip coil
 f : Measuring frequency

Looking for pricing, stock, or lifecycle information?

Click below to explore more details on WIN SOURCE:

-  [View LQP02TN9N1H02D on WIN SOURCE](#)
-  [Murata Electronics North America Information](#)

Optimize Your Supply Chain with WIN SOURCE Solutions

-  Global Sourcing Solution
-  Obsolete Management
-  Cost Control Management
-  Shortage Management
-  Alternative Solution
-  Excess Inventory Management