



THE DATASHEET OF MC78L15ACP_{RA}G



MC78L00A Series, NCV78L00A



Figure 2. Standard Application

A common ground is required between the input and the output voltages. The input voltage must remain typically 2.0 V above the output voltage even during the low point on the input ripple voltage.

* C_{in} is required if regulator is located an appreciable distance from power supply filter.

** C_O is not needed for stability; however, it does improve transient response.

ABSOLUTE MAXIMUM RATINGS

Rating	Symbol	Value	Unit
Input Voltage (5.0 V–9.0 V) (12 V–18 V) (24 V)	V_I	30 35 40	Vdc
Storage Temperature Range	T_{stg}	-65 to +150	°C
Maximum Junction Temperature	T_J	150	°C
Moisture Sensitivity Level	MSL	1	–
ESD Capability, Human Body Model (Note 1)	ESD_{HBM}	2000	V
ESD Capability, Machine Model (Note 1)	ESD_{MM}	200	V
ESD Capability, Charged Device Model (Note 1)	ESD_{CDM}	2000	V

Stresses exceeding those listed in the Maximum Ratings table may damage the device. If any of these limits are exceeded, device functionality should not be assumed, damage may occur and reliability may be affected.

1. This device series incorporates ESD protection and is tested by the following methods:

ESD Human Body Model tested per AEC-Q100-002 (EIA/JESD22-A114)

ESD Machine Model tested per AEC-Q100-003 (EIA/JESD22-A115)

ESD Charged Device Model tested per EIA/JES D22/C101, Field Induced Charge Model.

THERMAL CHARACTERISTICS

Rating	Symbol	Value	Unit
Package Dissipation	PD	Internally Limited	W
Thermal Characteristics, TO-92 Thermal Resistance, Junction-to-Ambient	$R_{\theta JA}$	200	°C/W
Thermal Characteristics, SOIC8 Thermal Resistance, Junction-to-Ambient	$R_{\theta JA}$	Refer to Figure 8	°C/W
Thermal Characteristics, SOT-89 Thermal Resistance, Junction-to-Ambient	$R_{\theta JA}$	55	°C/W

2. Thermal Resistance, Junction-to-Ambient depends on P.C.B. Copper area. See details in Figure 8.

Thermal Resistance, Junction-to-Case is not defined. SOIC 8 lead and TO-92 packages that do not have a heat sink like other packages may have. This is the reason that a θ_{JC} is never specified. A little heat transfer will occur through the package but since it is plastic, it is minimal. The majority of the heat that is transferred is through the leads where they connect to the circuit board.

MC78L00A Series, NCV78L00A

ELECTRICAL CHARACTERISTICS ($V_I = 10\text{ V}$, $I_O = 40\text{ mA}$, $C_I = 0.33\text{ }\mu\text{F}$, $C_O = 0.1\text{ }\mu\text{F}$, $-40^\circ\text{C} < T_J < +125^\circ\text{C}$ (for MC78LXXAB, NCV78L05A), $0^\circ\text{C} < T_J < +125^\circ\text{C}$ (for MC78LXXAC), unless otherwise noted.)

Characteristics	Symbol	MC78L05AC, AB, NCV78L05A			Unit
		Min	Typ	Max	
Output Voltage ($T_J = +25^\circ\text{C}$)	V_O	4.8	5.0	5.2	Vdc
Line Regulation ($T_J = +25^\circ\text{C}$, $I_O = 40\text{ mA}$) $7.0\text{ Vdc} \leq V_I \leq 20\text{ Vdc}$ $8.0\text{ Vdc} \leq V_I \leq 20\text{ Vdc}$	Reg_{line}	– –	55 45	150 100	mV
Load Regulation ($T_J = +25^\circ\text{C}$, $1.0\text{ mA} \leq I_O \leq 100\text{ mA}$) ($T_J = +25^\circ\text{C}$, $1.0\text{ mA} \leq I_O \leq 40\text{ mA}$)	Reg_{load}	– –	11 5.0	60 30	mV
Output Voltage ($7.0\text{ Vdc} \leq V_I \leq 20\text{ Vdc}$, $1.0\text{ mA} \leq I_O \leq 40\text{ mA}$) ($V_I = 10\text{ V}$, $1.0\text{ mA} \leq I_O \leq 70\text{ mA}$)	V_O	4.75 4.75	– –	5.25 5.25	Vdc
Input Bias Current ($T_J = +25^\circ\text{C}$) ($T_J = +125^\circ\text{C}$)	I_{IB}	– –	3.8 –	6.0 5.5	mA
Input Bias Current Change ($8.0\text{ Vdc} \leq V_I \leq 20\text{ Vdc}$) ($1.0\text{ mA} \leq I_O \leq 40\text{ mA}$)	ΔI_{IB}	– –	– –	1.5 0.1	mA
Output Noise Voltage ($T_A = +25^\circ\text{C}$, $10\text{ Hz} \leq f \leq 100\text{ kHz}$)	V_n	–	40	–	μV
Ripple Rejection ($I_O = 40\text{ mA}$, $f = 120\text{ Hz}$, $8.0\text{ Vdc} \leq V_I \leq 18\text{ V}$, $T_J = +25^\circ\text{C}$)	RR	41	49	–	dB
Dropout Voltage ($T_J = +25^\circ\text{C}$)	$V_I - V_O$	–	1.7	–	Vdc

NOTE: NCV78L05A: $T_{\text{low}} = -40^\circ\text{C}$, $T_{\text{high}} = +125^\circ\text{C}$. Guaranteed by design. NCV prefix is for automotive and other applications requiring site and change control.

ELECTRICAL CHARACTERISTICS ($V_I = 14\text{ V}$, $I_O = 40\text{ mA}$, $C_I = 0.33\text{ }\mu\text{F}$, $C_O = 0.1\text{ }\mu\text{F}$, $-40^\circ\text{C} < T_J < +125^\circ\text{C}$ (for MC78LXXAB), $0^\circ\text{C} < T_J < +125^\circ\text{C}$ (for MC78LXXAC), unless otherwise noted.)

Characteristics	Symbol	MC78L08AC, AB			Unit
		Min	Typ	Max	
Output Voltage ($T_J = +25^\circ\text{C}$)	V_O	7.7	8.0	8.3	Vdc
Line Regulation ($T_J = +25^\circ\text{C}$, $I_O = 40\text{ mA}$) $10.5\text{ Vdc} \leq V_I \leq 23\text{ Vdc}$ $11\text{ Vdc} \leq V_I \leq 23\text{ Vdc}$	Reg_{line}	– –	20 12	175 125	mV
Load Regulation ($T_J = +25^\circ\text{C}$, $1.0\text{ mA} \leq I_O \leq 100\text{ mA}$) ($T_J = +25^\circ\text{C}$, $1.0\text{ mA} \leq I_O \leq 40\text{ mA}$)	Reg_{load}	– –	15 8.0	80 40	mV
Output Voltage ($10.5\text{ Vdc} \leq V_I \leq 23\text{ Vdc}$, $1.0\text{ mA} \leq I_O \leq 40\text{ mA}$) ($V_I = 14\text{ V}$, $1.0\text{ mA} \leq I_O \leq 70\text{ mA}$)	V_O	7.6 7.6	– –	8.4 8.4	Vdc
Input Bias Current ($T_J = +25^\circ\text{C}$) ($T_J = +125^\circ\text{C}$)	I_{IB}	– –	3.0 –	6.0 5.5	mA
Input Bias Current Change ($11\text{ Vdc} \leq V_I \leq 23\text{ Vdc}$) ($1.0\text{ mA} \leq I_O \leq 40\text{ mA}$)	ΔI_{IB}	– –	– –	1.5 0.1	mA
Output Noise Voltage ($T_A = +25^\circ\text{C}$, $10\text{ Hz} \leq f \leq 100\text{ kHz}$)	V_n	–	60	–	μV
Ripple Rejection ($I_O = 40\text{ mA}$, $f = 120\text{ Hz}$, $12\text{ V} \leq V_I \leq 23\text{ V}$, $T_J = +25^\circ\text{C}$)	RR	37	57	–	dB
Dropout Voltage ($T_J = +25^\circ\text{C}$)	$V_I - V_O$	–	1.7	–	Vdc

MC78L00A Series, NCV78L00A

ELECTRICAL CHARACTERISTICS ($V_I = 15\text{ V}$, $I_O = 40\text{ mA}$, $C_I = 0.33\text{ }\mu\text{F}$, $C_O = 0.1\text{ }\mu\text{F}$, $-40^\circ\text{C} < T_J < +125^\circ\text{C}$ (for MC78LXXAB), $0^\circ\text{C} < T_J < +125^\circ\text{C}$ (for MC78LXXAC), unless otherwise noted.)

Characteristics	Symbol	MC78L09AC, AB			Unit
		Min	Typ	Max	
Output Voltage ($T_J = +25^\circ\text{C}$)	V_O	8.6	9.0	9.4	Vdc
Line Regulation ($T_J = +25^\circ\text{C}$, $I_O = 40\text{ mA}$) $11.5\text{ Vdc} \leq V_I \leq 24\text{ Vdc}$ $12\text{ Vdc} \leq V_I \leq 24\text{ Vdc}$	Reg_{line}	–	20 12	175 125	mV
Load Regulation ($T_J = +25^\circ\text{C}$, $1.0\text{ mA} \leq I_O \leq 100\text{ mA}$) ($T_J = +25^\circ\text{C}$, $1.0\text{ mA} \leq I_O \leq 40\text{ mA}$)	Reg_{load}	–	15 8.0	90 40	mV
Output Voltage ($11.5\text{ Vdc} \leq V_I \leq 24\text{ Vdc}$, $1.0\text{ mA} \leq I_O \leq 40\text{ mA}$) ($V_I = 15\text{ V}$, $1.0\text{ mA} \leq I_O \leq 70\text{ mA}$)	V_O	8.5 8.5	– –	9.5 9.5	Vdc
Input Bias Current ($T_J = +25^\circ\text{C}$) ($T_J = +125^\circ\text{C}$)	I_{IB}	– –	3.0 –	6.0 5.5	mA
Input Bias Current Change ($11\text{ Vdc} \leq V_I \leq 23\text{ Vdc}$) ($1.0\text{ mA} \leq I_O \leq 40\text{ mA}$)	ΔI_{IB}	– –	– –	1.5 0.1	mA
Output Noise Voltage ($T_A = +25^\circ\text{C}$, $10\text{ Hz} \leq f \leq 100\text{ kHz}$)	V_n	–	60	–	μV
Ripple Rejection ($I_O = 40\text{ mA}$, $f = 120\text{ Hz}$, $13\text{ V} \leq V_I \leq 24\text{ V}$, $T_J = +25^\circ\text{C}$)	RR	37	57	–	dB
Dropout Voltage ($T_J = +25^\circ\text{C}$)	$V_I - V_O$	–	1.7	–	Vdc

ELECTRICAL CHARACTERISTICS ($V_I = 19\text{ V}$, $I_O = 40\text{ mA}$, $C_I = 0.33\text{ }\mu\text{F}$, $C_O = 0.1\text{ }\mu\text{F}$, $-40^\circ\text{C} < T_J < +125^\circ\text{C}$ (for MC78LXXAB), $0^\circ\text{C} < T_J < +125^\circ\text{C}$ (for MC78LXXAC), unless otherwise noted.)

Characteristics	Symbol	MC78L12AC, AB			Unit
		Min	Typ	Max	
Output Voltage ($T_J = +25^\circ\text{C}$)	V_O	11.5	12	12.5	Vdc
Line Regulation ($T_J = +25^\circ\text{C}$, $I_O = 40\text{ mA}$) $14.5\text{ Vdc} \leq V_I \leq 27\text{ Vdc}$ $16\text{ Vdc} \leq V_I \leq 27\text{ Vdc}$	Reg_{line}	– –	120 100	250 200	mV
Load Regulation ($T_J = +25^\circ\text{C}$, $1.0\text{ mA} \leq I_O \leq 100\text{ mA}$) ($T_J = +25^\circ\text{C}$, $1.0\text{ mA} \leq I_O \leq 40\text{ mA}$)	Reg_{load}	– –	20 10	100 50	mV
Output Voltage ($14.5\text{ Vdc} \leq V_I \leq 27\text{ Vdc}$, $1.0\text{ mA} \leq I_O \leq 40\text{ mA}$) ($V_I = 19\text{ V}$, $1.0\text{ mA} \leq I_O \leq 70\text{ mA}$)	V_O	11.4 11.4	– –	12.6 12.6	Vdc
Input Bias Current ($T_J = +25^\circ\text{C}$) ($T_J = +125^\circ\text{C}$)	I_{IB}	– –	4.2 –	6.5 6.0	mA
Input Bias Current Change ($16\text{ Vdc} \leq V_I \leq 27\text{ Vdc}$) ($1.0\text{ mA} \leq I_O \leq 40\text{ mA}$)	ΔI_{IB}	– –	– –	1.5 0.1	mA
Output Noise Voltage ($T_A = +25^\circ\text{C}$, $10\text{ Hz} \leq f \leq 100\text{ kHz}$)	V_n	–	80	–	μV
Ripple Rejection ($I_O = 40\text{ mA}$, $f = 120\text{ Hz}$, $15\text{ V} \leq V_I \leq 25\text{ V}$, $T_J = +25^\circ\text{C}$)	RR	37	42	–	dB
Dropout Voltage ($T_J = +25^\circ\text{C}$)	$V_I - V_O$	–	1.7	–	Vdc

MC78L00A Series, NCV78L00A

ELECTRICAL CHARACTERISTICS ($V_I = 23\text{ V}$, $I_O = 40\text{ mA}$, $C_I = 0.33\text{ }\mu\text{F}$, $C_O = 0.1\text{ }\mu\text{F}$, $-40^\circ\text{C} < T_J < +125^\circ\text{C}$ (for MC78LXXAB), $0^\circ\text{C} < T_J < +125^\circ\text{C}$ (for MC78LXXAC), unless otherwise noted.)

Characteristics	Symbol	MC78L15AC, AB / NCV78L15A			Unit
		Min	Typ	Max	
Output Voltage ($T_J = +25^\circ\text{C}$)	V_O	14.4	15	15.6	Vdc
Line Regulation ($T_J = +25^\circ\text{C}$, $I_O = 40\text{ mA}$) $17.5\text{ Vdc} \leq V_I \leq 30\text{ Vdc}$ $20\text{ Vdc} \leq V_I \leq 30\text{ Vdc}$	Reg_{line}	–	130 110	300 250	mV
Load Regulation ($T_J = +25^\circ\text{C}$, $1.0\text{ mA} \leq I_O \leq 100\text{ mA}$) ($T_J = +25^\circ\text{C}$, $1.0\text{ mA} \leq I_O \leq 40\text{ mA}$)	Reg_{load}	–	25 12	150 75	mV
Output Voltage ($17.5\text{ Vdc} \leq V_I \leq 30\text{ Vdc}$, $1.0\text{ mA} \leq I_O \leq 40\text{ mA}$) ($V_I = 23\text{ V}$, $1.0\text{ mA} \leq I_O \leq 70\text{ mA}$)	V_O	14.25 14.25	– –	15.75 15.75	Vdc
Input Bias Current ($T_J = +25^\circ\text{C}$) ($T_J = +125^\circ\text{C}$)	I_{IB}	– –	4.4 –	6.5 6.0	mA
Input Bias Current Change ($20\text{ Vdc} \leq V_I \leq 30\text{ Vdc}$) ($1.0\text{ mA} \leq I_O \leq 40\text{ mA}$)	ΔI_{IB}	– –	– –	1.5 0.1	mA
Output Noise Voltage ($T_A = +25^\circ\text{C}$, $10\text{ Hz} \leq f \leq 100\text{ kHz}$)	V_n	–	90	–	μV
Ripple Rejection ($I_O = 40\text{ mA}$, $f = 120\text{ Hz}$, $18.5\text{ V} \leq V_I \leq 28.5\text{ V}$, $T_J = +25^\circ\text{C}$)	RR	34	39	–	dB
Dropout Voltage ($T_J = +25^\circ\text{C}$)	$V_I - V_O$	–	1.7	–	Vdc

ELECTRICAL CHARACTERISTICS ($V_I = 27\text{ V}$, $I_O = 40\text{ mA}$, $C_I = 0.33\text{ }\mu\text{F}$, $C_O = 0.1\text{ }\mu\text{F}$, $0^\circ\text{C} < T_J < +125^\circ\text{C}$, unless otherwise noted.)

Characteristics	Symbol	MC78L18AC			Unit
		Min	Typ	Max	
Output Voltage ($T_J = +25^\circ\text{C}$)	V_O	17.3	18	18.7	Vdc
Line Regulation ($T_J = +25^\circ\text{C}$, $I_O = 40\text{ mA}$) $21.4\text{ Vdc} \leq V_I \leq 33\text{ Vdc}$ $20.7\text{ Vdc} \leq V_I \leq 33\text{ Vdc}$ $22\text{ Vdc} \leq V_I \leq 33\text{ Vdc}$ $21\text{ Vdc} \leq V_I \leq 33\text{ Vdc}$	Reg_{line}	–	45 35	325 275	mV
Load Regulation ($T_J = +25^\circ\text{C}$, $1.0\text{ mA} \leq I_O \leq 100\text{ mA}$) ($T_J = +25^\circ\text{C}$, $1.0\text{ mA} \leq I_O \leq 40\text{ mA}$)	Reg_{load}	–	30 15	170 85	mV
Output Voltage ($21.4\text{ Vdc} \leq V_I \leq 33\text{ Vdc}$, $1.0\text{ mA} \leq I_O \leq 40\text{ mA}$) ($20.7\text{ Vdc} \leq V_I \leq 33\text{ Vdc}$, $1.0\text{ mA} \leq I_O \leq 40\text{ mA}$) ($V_I = 27\text{ V}$, $1.0\text{ mA} \leq I_O \leq 70\text{ mA}$) ($V_I = 27\text{ V}$, $1.0\text{ mA} \leq I_O \leq 70\text{ mA}$)	V_O	17.1 17.1	– –	18.9 18.9	Vdc
Input Bias Current ($T_J = +25^\circ\text{C}$) ($T_J = +125^\circ\text{C}$)	I_{IB}	– –	3.1 –	6.5 6.0	mA
Input Bias Current Change ($22\text{ Vdc} \leq V_I \leq 33\text{ Vdc}$) ($21\text{ Vdc} \leq V_I \leq 33\text{ Vdc}$) ($1.0\text{ mA} \leq I_O \leq 40\text{ mA}$)	ΔI_{IB}	– –	– –	1.5 0.1	mA
Output Noise Voltage ($T_A = +25^\circ\text{C}$, $10\text{ Hz} \leq f \leq 100\text{ kHz}$)	V_n	–	150	–	μV
Ripple Rejection ($I_O = 40\text{ mA}$, $f = 120\text{ Hz}$, $23\text{ V} \leq V_I \leq 33\text{ V}$, $T_J = +25^\circ\text{C}$)	RR	33	48	–	dB
Dropout Voltage ($T_J = +25^\circ\text{C}$)	$V_I - V_O$	–	1.7	–	Vdc

MC78L00A Series, NCV78L00A

ELECTRICAL CHARACTERISTICS ($V_I = 33\text{ V}$, $I_O = 40\text{ mA}$, $C_I = 0.33\text{ }\mu\text{F}$, $C_O = 0.1\text{ }\mu\text{F}$, $0^\circ\text{C} < T_J < +125^\circ\text{C}$, unless otherwise noted.)

Characteristics	Symbol	MC78L24AC			Unit
		Min	Typ	Max	
Output Voltage ($T_J = +25^\circ\text{C}$)	V_O	23	24	25	Vdc
Line Regulation ($T_J = +25^\circ\text{C}$, $I_O = 40\text{ mA}$) $27.5\text{ Vdc} \leq V_I \leq 38\text{ Vdc}$ $28\text{ Vdc} \leq V_I \leq 80\text{ Vdc}$ $27\text{ Vdc} \leq V_I \leq 38\text{ Vdc}$	Reg_{line}	–	–	–	mV
Load Regulation ($T_J = +25^\circ\text{C}$, $1.0\text{ mA} \leq I_O \leq 100\text{ mA}$) ($T_J = +25^\circ\text{C}$, $1.0\text{ mA} \leq I_O \leq 40\text{ mA}$)	Reg_{load}	–	40	200	mV
Output Voltage ($28\text{ Vdc} \leq V_I \leq 38\text{ Vdc}$, $1.0\text{ mA} \leq I_O \leq 40\text{ mA}$) ($27\text{ Vdc} \leq V_I \leq 38\text{ Vdc}$, $1.0\text{ mA} \leq I_O \leq 40\text{ mA}$) ($28\text{ Vdc} \leq V_I \leq 33\text{ Vdc}$, $1.0\text{ mA} \leq I_O \leq 70\text{ mA}$) ($27\text{ Vdc} \leq V_I \leq 33\text{ Vdc}$, $1.0\text{ mA} \leq I_O \leq 70\text{ mA}$)	V_O	22.8	–	25.2	Vdc
Input Bias Current ($T_J = +25^\circ\text{C}$) ($T_J = +125^\circ\text{C}$)	I_{IB}	–	3.1	6.5	mA
Input Bias Current Change ($28\text{ Vdc} \leq V_I \leq 38\text{ Vdc}$) ($1.0\text{ mA} \leq I_O \leq 40\text{ mA}$)	ΔI_{IB}	–	–	1.5	mA
Output Noise Voltage ($T_A = +25^\circ\text{C}$, $10\text{ Hz} \leq f \leq 100\text{ kHz}$)	V_n	–	200	–	μV
Ripple Rejection ($I_O = 40\text{ mA}$, $f = 120\text{ Hz}$, $29\text{ V} \leq V_I \leq 35\text{ V}$, $T_J = +25^\circ\text{C}$)	RR	31	45	–	dB
Dropout Voltage ($T_J = +25^\circ\text{C}$)	$V_I - V_O$	–	1.7	–	Vdc

Product parametric performance is indicated in the Electrical Characteristics for the listed test conditions, unless otherwise noted. Product performance may not be indicated by the Electrical Characteristics if operated under different conditions.

MC78L00A Series, NCV78L00A



Figure 3. Dropout Characteristics



Figure 4. Dropout Voltage versus Junction Temperature



Figure 5. Input Bias Current versus Ambient Temperature



Figure 6. Input Bias Current versus Input Voltage



Figure 7. Maximum Average Power Dissipation versus Ambient Temperature – TO-92 Type Package

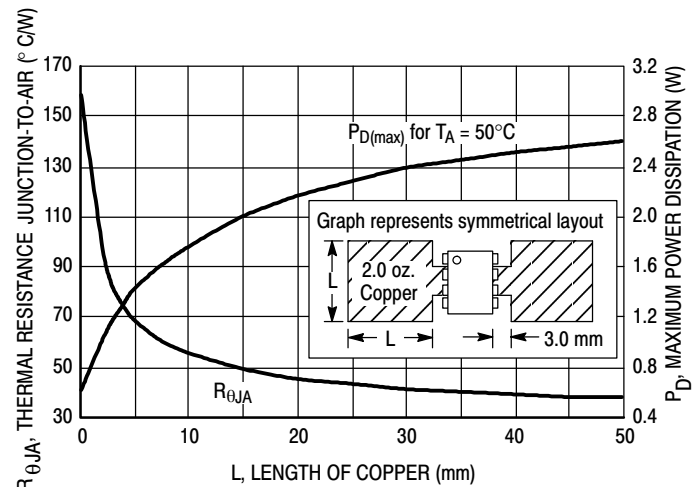

Figure 8. SOIC-8 Thermal Resistance and Maximum Power Dissipation versus P.C.B. Copper Length

MC78L00A Series, NCV78L00A

APPLICATIONS INFORMATION

Design Considerations

The MC78L00A Series of fixed voltage regulators are designed with Thermal Overload Protection that shuts down the circuit when subjected to an excessive power overload condition. Internal Short Circuit Protection limits the maximum current the circuit will pass.

In many low current applications, compensation capacitors are not required. However, it is recommended that the regulator input be bypassed with a capacitor if the regulator is connected to the power supply filter with long wire lengths, or if the output load capacitance is large. The

input bypass capacitor should be selected to provide good high-frequency characteristics to insure stable operation under all load conditions. A 0.33 μF or larger tantalum, mylar, or other capacitor having low internal impedance at high frequencies should be chosen. The bypass capacitor should be mounted with the shortest possible leads directly across the regulators input terminals. Good construction techniques should be used to minimize ground loops and lead resistance drops since the regulator has no external sense lead. Bypassing the output is also recommended.



The MC78L00 regulators can also be used as a current source when connected as above. In order to minimize dissipation the MC78L05C is chosen in this application. Resistor R determines the current as follows:

$$I_O = \frac{5.0 \text{ V}}{R} + I_B$$

$$I_B = 3.8 \text{ mA over line and load changes}$$

For example, a 100 mA current source would require R to be a 50 Ω, 1/2 W resistor and the output voltage compliance would be the input voltage less 7 V.

Figure 9. Current Regulator

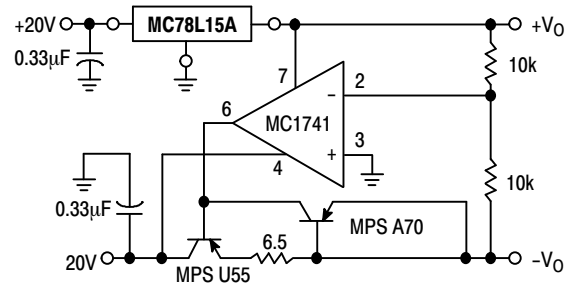

Figure 10. ±15 V Tracking Voltage Regulator

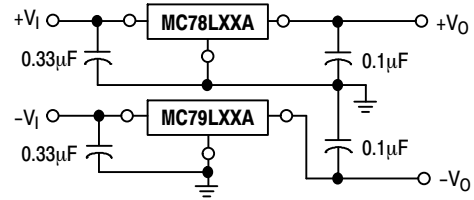

Figure 11. Positive and Negative Regulator

MC78L00A Series, NCV78L00A

ORDERING INFORMATION

Device	Output Voltage	Operating Temperature Range	Package	Shipping [†]
MC78L05ABDG	5.0 V	T _J = -40° to +125°C	SOIC-8 (Pb-Free)	98 Units / Rail
NCV78L05ABDG*	5.0 V	T _J = -40° to +125°C	SOIC-8 (Pb-Free)	98 Units / Rail
MC78L05ABDR2G	5.0 V	T _J = -40° to +125°C	SOIC-8 (Pb-Free)	2500 / Tape & Reel
NCV78L05ABDR2G*	5.0 V	T _J = -40° to +125°C	SOIC-8 (Pb-Free)	2500 / Tape & Reel
MC78L05ABPG	5.0 V	T _J = -40° to +125°C	TO-92 (Pb-Free)	2000 Units / Bag
NCV78L05ABPG*	5.0 V	T _J = -40° to +125°C	TO-92 (Pb-Free)	2000 Units / Bag
MC78L05ABPRAG	5.0 V	T _J = -40° to +125°C	TO-92 (Pb-Free)	2000 / Tape & Reel
NCV78L05ABPRAG*	5.0 V	T _J = -40° to +125°C	TO-92 (Pb-Free)	2000 / Tape & Reel
MC78L05ABPREG	5.0 V	T _J = -40° to +125°C	TO-92 (Pb-Free)	2000 / Tape & Reel
NCV78L05ABPREG*	5.0 V	T _J = -40° to +125°C	TO-92 (Pb-Free)	2000 / Tape & Reel
MC78L05ABPRMG	5.0 V	T _J = -40° to +125°C	TO-92 (Pb-Free)	2000 / Ammo Pack
NCV78L05ABPRMG*	5.0 V	T _J = -40° to +125°C	TO-92 (Pb-Free)	2000 / Ammo Pack
NCV78L05ABPRPG*	5.0 V	T _J = -40° to +125°C	TO-92 (Pb-Free)	2000 / Ammo Pack
MC78L05ACDG	5.0 V	T _J = 0° to +125°C	SOIC-8 (Pb-Free)	98 Units / Rail
MC78L05ACDR2G	5.0 V	T _J = 0° to +125°C	SOIC-8 (Pb-Free)	2500 / Tape & Reel
MC78L05ACPG	5.0 V	T _J = 0° to +125°C	TO-92 (Pb-Free)	2000 Units / Bag
MC78L05ACPRAG	5.0 V	T _J = 0° to +125°C	TO-92 (Pb-Free)	2000 / Tape & Reel
MC78L05ACPREG	5.0 V	T _J = 0° to +125°C	TO-92 (Pb-Free)	2000 / Tape & Reel
MC78L05ACPRMG	5.0 V	T _J = 0° to +125°C	TO-92 (Pb-Free)	2000 / Ammo Pack
MC78L05ACPRPG	5.0 V	T _J = 0° to +125°C	TO-92 (Pb-Free)	2000 / Ammo Pack
MC78L05ACHT1G	5.0 V	T _J = 0° to +125°C	SOT-89 (Pb-Free)	2500 / Tape & Reel
MC78L08ABDG	8.0 V	T _J = -40° to +125°C	SOIC-8 (Pb-Free)	98 Units / Rail

*NCV78L05A, NCV78L12A, NCV78L15A: T_{low} = -40°C, T_{high} = +125°C. Guaranteed by design. NCV Prefix for Automotive and Other Applications Requiring Unique Site and Control Change Requirements; AEC-Q100 Qualified and PPAP Capable.

†For information on tape and reel specifications, including part orientation and tape sizes, please refer to our Tape and Reel Packaging Specifications Brochure, BRD8011/D.

MC78L00A Series, NCV78L00A

ORDERING INFORMATION (continued)

Device	Output Voltage	Operating Temperature Range	Package	Shipping [†]
MC78L08ABDR2G	8.0 V	T _J = -40° to +125°C	SOIC-8 (Pb-Free)	2500 / Tape & Reel
NCV78L08ABDR2G*	8.0 V	T _J = -40° to +125°C	SOIC-8 (Pb-Free)	2500 / Tape & Reel
MC78L08ABPG	8.0 V	T _J = -40° to +125°C	TO-92 (Pb-Free)	2000 Units / Bag
MC78L08ABPRAG	8.0 V	T _J = -40° to +125°C	TO-92 (Pb-Free)	2000 / Tape & Reel
MC78L08ABPRPG	8.0 V	T _J = -40° to +125°C	TO-92 (Pb-Free)	2000 / Ammo Pack
MC78L08ACDG	8.0 V	T _J = 0° to +125°C	SOIC-8 (Pb-Free)	98 Units / Rail
MC78L08ACDR2G	8.0 V	T _J = 0° to +125°C	SOIC-8 (Pb-Free)	2500 / Tape & Reel
MC78L08ACPG	8.0 V	T _J = 0° to +125°C	TO-92 (Pb-Free)	2000 Units / Bag
MC78L08ACPRAG	8.0 V	T _J = 0° to +125°C	TO-92 (Pb-Free)	2000 / Tape & Reel
MC78L08ACPREG	8.0 V	T _J = 0° to +125°C	TO-92 (Pb-Free)	2000 / Tape & Reel
MC78L08ACPRPG	8.0 V	T _J = 0° to +125°C	TO-92 (Pb-Free)	2000 / Ammo Pack
MC78L09ABDG	9.0 V	T _J = -40° to +125°C	SOIC-8 (Pb-Free)	98 Units / Rail
MC78L09ABDR2G	9.0 V	T _J = -40° to +125°C	SOIC-8 (Pb-Free)	2500 / Tape & Reel
MC78L09ABPRAG	9.0 V	T _J = -40° to +125°C	TO-92 (Pb-Free)	2000 / Tape & Reel
MC78L09ABPRPG	9.0 V	T _J = -40° to +125°C	TO-92 (Pb-Free)	2000 / Ammo Pack
MC78L09ACDG	9.0 V	T _J = 0° to +125°C	SOIC-8 (Pb-Free)	98 Units / Rail
MC78L09ACDR2G	9.0 V	T _J = 0° to +125°C	SOIC-8 (Pb-Free)	2500 / Tape & Reel
MC78L09ACPG	9.0 V	T _J = 0° to +125°C	TO-92 (Pb-Free)	2000 Units / Bag
MC78L12ABDG	12 V	T _J = -40° to +125°C	SOIC-8 (Pb-Free)	98 Units / Rail
MC78L12ABDR2G	12 V	T _J = -40° to +125°C	SOIC-8 (Pb-Free)	2500 / Tape & Reel
NCV78L12ABDG*	12 V	T _J = -40° to +125°C	SOIC-8 (Pb-Free)	98 Units / Rail
NCV78L12ABDR2G*	12 V	T _J = -40° to +125°C	SOIC-8 (Pb-Free)	2500 / Tape & Reel
MC78L12ABPG	12 V	T _J = -40° to +125°C	TO-92 (Pb-Free)	2000 Units / Bag

*NCV78L05A, NCV78L12A, NCV78L15A: T_{low} = -40°C, T_{high} = +125°C. Guaranteed by design. NCV Prefix for Automotive and Other Applications Requiring Unique Site and Control Change Requirements; AEC-Q100 Qualified and PPAP Capable.

†For information on tape and reel specifications, including part orientation and tape sizes, please refer to our Tape and Reel Packaging Specifications Brochure, BRD8011/D.

MC78L00A Series, NCV78L00A

ORDERING INFORMATION (continued)

Device	Output Voltage	Operating Temperature Range	Package	Shipping [†]
MC78L12ABPRPG	12 V	T _J = -40° to +125°C	TO-92 (Pb-Free)	2000 / Ammo Pack
NCV78L12ABPG*	12 V	T _J = -40° to +125°C	TO-92 (Pb-Free)	2000 Units / Bag
MC78L12ACDG	12 V	T _J = 0° to +125°C	SOIC-8 (Pb-Free)	98 Units / Rail
MC78L12ACDR2G	12 V	T _J = 0° to +125°C	SOIC-8 (Pb-Free)	2500 / Tape & Reel
MC78L12ACPG	12 V	T _J = 0° to +125°C	TO-92 (Pb-Free)	2000 Units / Bag
MC78L12ACPRAG	12 V	T _J = 0° to +125°C	TO-92 (Pb-Free)	2000 / Tape & Reel
MC78L12ACPREG	12 V	T _J = 0° to +125°C	TO-92 (Pb-Free)	2000 / Tape & Reel
MC78L12ACPRMG	12 V	T _J = 0° to +125°C	TO-92 (Pb-Free)	2000 / Ammo Pack
MC78L12ACPRPG	12 V	T _J = 0° to +125°C	TO-92 (Pb-Free)	2000 / Ammo Pack
MC78L15ABDG	15 V	T _J = -40° to +125°C	SOIC-8 (Pb-Free)	98 Units / Rail
MC78L15ABDR2G	15 V	T _J = -40° to +125°C	SOIC-8 (Pb-Free)	2500 / Tape & Reel
NCV78L15ABDR2G*	15 V	T _J = -40° to +125°C	SOIC-8 (Pb-Free)	2500 / Tape & Reel
MC78L15ABPG	15 V	T _J = -40° to +125°C	TO-92 (Pb-Free)	2000 Units / Bag
MC78L15ABPRAG	15 V	T _J = -40° to +125°C	TO-92 (Pb-Free)	2000 / Tape & Reel
MC78L15ABPRPG	15 V	T _J = -40° to +125°C	TO-92 (Pb-Free)	2000 / Ammo Pack
MC78L15ACDG	15 V	T _J = 0° to +125°C	SOIC-8 (Pb-Free)	98 Units / Rail
MC78L15ACDR2G	15 V	T _J = 0° to +125°C	SOIC-8 (Pb-Free)	2500 / Tape & Reel
MC78L15ACPG	15 V	T _J = 0° to +125°C	TO-92 (Pb-Free)	2000 Units / Bag
MC78L15ACPRAG	15 V	T _J = 0° to +125°C	TO-92 (Pb-Free)	2000 / Tape & Reel
MC78L15ACPRPG	15 V	T _J = 0° to +125°C	TO-92 (Pb-Free)	2000 / Ammo Pack
MC78L18ABPG	18 V	T _J = -40° to +125°C	TO-92 (Pb-Free)	2000 Units / Bag
MC78L18ACPG	18 V	T _J = 0° to +125°C	TO-92 (Pb-Free)	2000 Units / Bag
MC78L18ACPRAG	18 V	T _J = 0° to +125°C	TO-92 (Pb-Free)	2000 / Tape & Reel

*NCV78L05A, NCV78L12A, NCV78L15A: T_{low} = -40°C, T_{high} = +125°C. Guaranteed by design. NCV Prefix for Automotive and Other Applications Requiring Unique Site and Control Change Requirements; AEC-Q100 Qualified and PPAP Capable.

†For information on tape and reel specifications, including part orientation and tape sizes, please refer to our Tape and Reel Packaging Specifications Brochure, BRD8011/D.

MC78L00A Series, NCV78L00A

ORDERING INFORMATION (continued)

Device	Output Voltage	Operating Temperature Range	Package	Shipping [†]
MC78L18ACPRMG	18 V	T _J = 0° to +125°C	TO-92 (Pb-Free)	2000 / Ammo Pack
MC78L18ACPRPG	18 V	T _J = 0° to +125°C	TO-92 (Pb-Free)	2000 / Ammo Pack
MC78L24ABPG	24 V	T _J = -40° to +125°C	TO-92 (Pb-Free)	2000 Units / Bag
NCV78L24ABPRPG*	24 V	T _J = -40° to +125°C	TO-92 (Pb-Free)	2000 Units / Bag
MC78L24ACPG	24 V	T _J = 0° to +125°C	TO-92 (Pb-Free)	2000 Units / Bag
MC78L24ACPRAG	24 V	T _J = 0° to +125°C	TO-92 (Pb-Free)	2000 / Tape & Reel
MC78L24ACPRPG	24 V	T _J = 0° to +125°C	TO-92 (Pb-Free)	2000 / Ammo Pack

*NCV78L05A, NCV78L12A, NCV78L15A: T_{low} = -40°C, T_{high} = +125°C. Guaranteed by design. NCV Prefix for Automotive and Other Applications Requiring Unique Site and Control Change Requirements; AEC-Q100 Qualified and PPAP Capable.

†For information on tape and reel specifications, including part orientation and tape sizes, please refer to our Tape and Reel Packaging Specifications Brochure, BRD8011/D.

MARKING DIAGRAMS

SOIC-8 D SUFFIX CASE 751

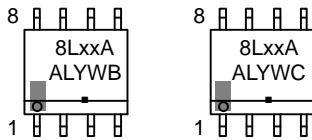

xx = 05, 08, 09, 12, or 15
 A = Assembly Location
 L = Wafer Lot
 Y = Year
 W = Work Week
 B, C = Temperature Range
 ■ = Pb-Free Package

SOT-89 CASE 528AG

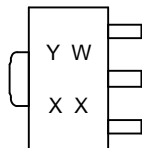

Y = Year
 W = Work Week
 XX = Specific Device Code

TO-92 P SUFFIX CASE 029



zz = 05, 08, 09, 12, 15, 18 or 24
 A = Assembly Location
 L = Wafer Lot
 Y = Year
 W = Work Week
 ■ = Pb-Free Package
 (Note: Microdot may be in either location)

MC78L00A Series, NCV78L00A

PACKAGE DIMENSIONS

SOIC-8 NB
CASE 751-07
ISSUE AK



NOTES:

1. DIMENSIONING AND TOLERANCING PER ANSI Y14.5M, 1982.
2. CONTROLLING DIMENSION: MILLIMETER.
3. DIMENSION A AND B DO NOT INCLUDE MOLD PROTRUSION.
4. MAXIMUM MOLD PROTRUSION 0.15 (0.006) PER SIDE.
5. DIMENSION D DOES NOT INCLUDE DAMBAR PROTRUSION. ALLOWABLE DAMBAR PROTRUSION SHALL BE 0.127 (0.005) TOTAL IN EXCESS OF THE D DIMENSION AT MAXIMUM MATERIAL CONDITION.
6. 751-01 THRU 751-06 ARE OBSOLETE. NEW STANDARD IS 751-07.

DIM	MILLIMETERS		INCHES	
	MIN	MAX	MIN	MAX
A	4.80	5.00	0.189	0.197
B	3.80	4.00	0.150	0.157
C	1.35	1.75	0.053	0.069
D	0.33	0.51	0.013	0.020
G	1.27 BSC		0.050 BSC	
H	0.10	0.25	0.004	0.010
J	0.19	0.25	0.007	0.010
K	0.40	1.27	0.016	0.050
M	0°	8°	0°	8°
N	0.25	0.50	0.010	0.020
S	5.80	6.20	0.228	0.244

SOLDERING FOOTPRINT*

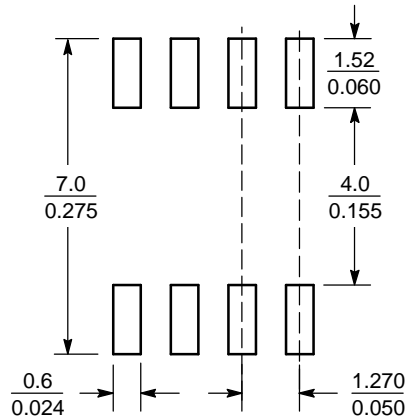

SCALE 6:1 ($\frac{\text{mm}}{\text{inches}}$)

*For additional information on our Pb-Free strategy and soldering details, please download the ON Semiconductor Soldering and Mounting Techniques Reference Manual, SOLDERRM/D.

MC78L00A Series, NCV78L00A

PACKAGE DIMENSIONS

TO-92 (TO-226)
CASE 029-11
ISSUE AM



STRAIGHT LEAD
BULK PACK

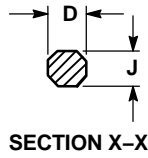

SECTION X-X

NOTES:

1. DIMENSIONING AND TOLERANCING PER ANSI Y14.5M, 1982.
2. CONTROLLING DIMENSION: INCH.
3. CONTOUR OF PACKAGE BEYOND DIMENSION R IS UNCONTROLLED.
4. LEAD DIMENSION IS UNCONTROLLED IN P AND BEYOND DIMENSION K MINIMUM.

DIM	INCHES		MILLIMETERS	
	MIN	MAX	MIN	MAX
A	0.175	0.205	4.45	5.20
B	0.170	0.210	4.32	5.33
C	0.125	0.165	3.18	4.19
D	0.016	0.021	0.407	0.533
G	0.045	0.055	1.15	1.39
H	0.095	0.105	2.42	2.66
J	0.015	0.020	0.39	0.50
K	0.500	---	12.70	---
L	0.250	---	6.35	---
N	0.080	0.105	2.04	2.66
P	---	0.100	---	2.54
R	0.115	---	2.93	---
V	0.135	---	3.43	---



BENT LEAD
TAPE & REEL
AMMO PACK

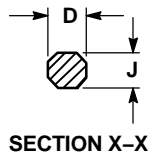

SECTION X-X

NOTES:

1. DIMENSIONING AND TOLERANCING PER ASME Y14.5M, 1994.
2. CONTROLLING DIMENSION: MILLIMETERS.
3. CONTOUR OF PACKAGE BEYOND DIMENSION R IS UNCONTROLLED.
4. LEAD DIMENSION IS UNCONTROLLED IN P AND BEYOND DIMENSION K MINIMUM.

DIM	MILLIMETERS	
	MIN	MAX
A	4.45	5.20
B	4.32	5.33
C	3.18	4.19
D	0.40	0.54
G	2.40	2.80
J	0.39	0.50
K	12.70	---
N	2.04	2.66
P	1.50	4.00
R	2.93	---
V	3.43	---

MC78L00A Series, NCV78L00A

PACKAGE DIMENSIONS

SOT-89, 3 LEAD
CASE 528AG
ISSUE O

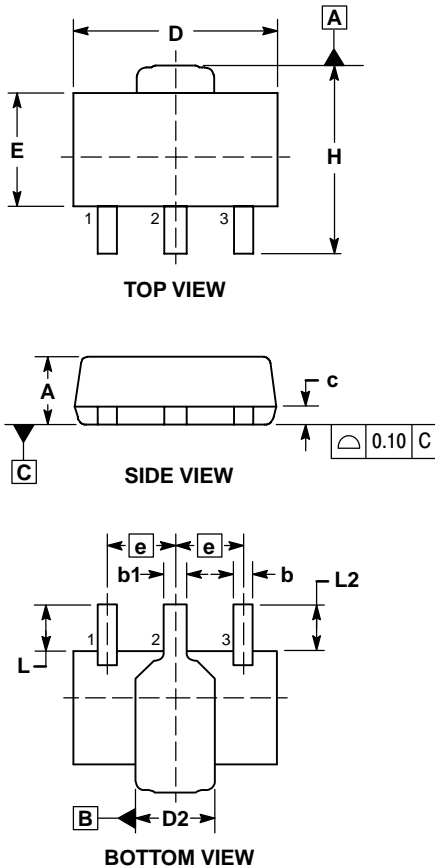

NOTES:

1. DIMENSIONING AND TOLERANCING PER ASME Y14.5M, 1994.
2. CONTROLLING DIMENSION: MILLIMETERS.
3. LEAD THICKNESS INCLUDES LEAD FINISH.
4. DIMENSIONS D AND E DO NOT INCLUDE MOLD FLASH, PROTRUSIONS, OR GATE BURRS.
5. DIMENSIONS L, L2, D2, AND H ARE MEASURED AT DATUM PLANE C.
6. CENTER LEAD CONTOUR MAY VARY WITHIN THE REGION DEFINED BY DIMENSION E.
7. DIMENSION D2 IS DEFINED AT ITS WIDEST POINT.

DIM	MILLIMETERS	
	MIN	MAX
A	1.40	1.60
b	0.38	0.47
b1	0.46	0.55
c	0.40	0.44
D	4.40	4.60
D2	1.60	1.90
E	2.40	2.60
e	1.50 BSC	
H	4.05	4.25
L	0.89	1.20

RECOMMENDED MOUNTING FOOTPRINT*



DIMENSIONS: MILLIMETERS

*For additional information on our Pb-Free strategy and soldering details, please download the ON Semiconductor Soldering and Mounting Techniques Reference Manual, SOLDERRM/D.

ON Semiconductor and are trademarks of Semiconductor Components Industries, LLC dba ON Semiconductor or its subsidiaries in the United States and/or other countries. ON Semiconductor owns the rights to a number of patents, trademarks, copyrights, trade secrets, and other intellectual property. A listing of ON Semiconductor's product/patent coverage may be accessed at www.onsemi.com/Site/pdf/Patent-Marketing.pdf. ON Semiconductor reserves the right to make changes without further notice to any products herein. ON Semiconductor makes no warranty, representation or guarantee regarding the suitability of its products for any particular purpose, nor does ON Semiconductor assume any liability arising out of the application or use of any product or circuit, and specifically disclaims any and all liability, including without limitation special, consequential or incidental damages. Buyer is responsible for its products and applications using ON Semiconductor products, including compliance with all laws, regulations and safety requirements or standards, regardless of any support or applications information provided by ON Semiconductor. "Typical" parameters which may be provided in ON Semiconductor data sheets and/or specifications can and do vary in different applications and actual performance may vary over time. All operating parameters, including "Typicals" must be validated for each customer application by customer's technical experts. ON Semiconductor does not convey any license under its patent rights nor the rights of others. ON Semiconductor products are not designed, intended, or authorized for use as a critical component in life support systems or any FDA Class 3 medical devices or medical devices with a same or similar classification in a foreign jurisdiction or any devices intended for implantation in the human body. Should Buyer purchase or use ON Semiconductor products for any such unintended or unauthorized application, Buyer shall indemnify and hold ON Semiconductor and its officers, employees, subsidiaries, affiliates, and distributors harmless against all claims, costs, damages, and expenses, and reasonable attorney fees arising out of, directly or indirectly, any claim of personal injury or death associated with such unintended or unauthorized use, even if such claim alleges that ON Semiconductor was negligent regarding the design or manufacture of the part. ON Semiconductor is an Equal Opportunity/Affirmative Action Employer. This literature is subject to all applicable copyright laws and is not for resale in any manner.

PUBLICATION ORDERING INFORMATION

LITERATURE FULFILLMENT:
Literature Distribution Center for ON Semiconductor
19521 E. 32nd Pkwy, Aurora, Colorado 80011 USA
Phone: 303-675-2175 or 800-344-3860 Toll Free USA/Canada
Fax: 303-675-2176 or 800-344-3867 Toll Free USA/Canada
Email: orderlit@onsemi.com

N. American Technical Support: 800-282-9855 Toll Free
USA/Canada
Europe, Middle East and Africa Technical Support:
Phone: 421 33 790 2910
Japan Customer Focus Center
Phone: 81-3-5817-1050

ON Semiconductor Website: www.onsemi.com
Order Literature: <http://www.onsemi.com/orderlit>

For additional information, please contact your local Sales Representative

Looking for pricing, stock, or lifecycle information?

Click below to explore more details on WIN SOURCE:

 [View MC78L15ACPBRAG on WIN SOURCE](#)

 [ON Semiconductor](#) Information

Optimize Your Supply Chain with WIN SOURCE Solutions

-  Global Sourcing Solution
-  Obsolete Management
-  Cost Control Management
-  Shortage Management
-  Alternative Solution
-  Excess Inventory Management