



**THE DATASHEET OF  
NTD65N03R-1G**



# NTD65N03R

## Power MOSFET 25 V, 65 A, Single N-Channel, DPAK

### Features

- Low  $R_{DS(on)}$
- Ultra Low Gate Charge
- Low Reverse Recovery Charge
- Pb-Free Packages are Available

### Applications

- Desktop CPU Power
- DC-DC Converters
- High and Low Side Switch

### MAXIMUM RATINGS ( $T_J = 25^\circ\text{C}$ unless otherwise noted)

Parameter	Symbol	Value	Unit	
Drain-to-Source Voltage	$V_{DSS}$	25	V	
Gate-to-Source Voltage	$V_{GS}$	$\pm 20$	V	
Continuous Drain Current ( $R_{\theta JC}$ ) Limited by Die	$I_D$	$T_C = 25^\circ\text{C}$	65	A
		$T_C = 85^\circ\text{C}$	45	A
Continuous Drain Current ( $R_{\theta JC}$ ) Limited by Wire	$I_D$	$T_C = 25^\circ\text{C}$	32	A
		$T_C = 25^\circ\text{C}$	$P_D$	50
Power Dissipation ( $R_{\theta JC}$ )				
Continuous Drain Current (Note 1)	$I_D$	$T_A = 25^\circ\text{C}$	11.4	A
		$T_A = 85^\circ\text{C}$	8.9	A
Power Dissipation (Note 1)	$P_D$	1.88	W	
Continuous Drain Current (Note 2)	$I_D$	$T_A = 25^\circ\text{C}$	9.5	A
		$T_A = 85^\circ\text{C}$	7.4	A
Power Dissipation (Note 2)	$P_D$	1.3	W	
Pulsed Drain Current	$t_p = 10 \mu\text{s}$	$I_{DM}$	130	A
Operating Junction and Storage Temperature	$T_J, T_{stg}$	-55 to 175	$^\circ\text{C}$	
Drain-to-Source (dv/dt)	dv/dt	2.0	V/ns	
Source Current (Body Diode)	$I_S$	2.1	A	
Single Pulse Drain-to-Source Avalanche Energy ( $V_{DD} = 24 \text{ V}, V_{GS} = 10 \text{ V}, I_L = 12 \text{ A}, L = 1.0 \text{ mH}, R_G = 25 \Omega$ )	$E_{AS}$	71.7	mJ	
Lead Temperature for Soldering Purposes (1/8" from case for 10 s)	$T_L$	260	$^\circ\text{C}$	

Stresses exceeding Maximum Ratings may damage the device. Maximum Ratings are stress ratings only. Functional operation above the Recommended Operating Conditions is not implied. Extended exposure to stresses above the Recommended Operating Conditions may affect device reliability.

1. Surface-mounted on FR4 board using 1 in sq pad size (Cu area = 1.127 in sq [1 oz] including traces).
2. Surface-mounted on FR4 board using the minimum recommended pad size (Cu area = 0.15 in sq [1 oz] including traces).



ON Semiconductor®

<http://onsemi.com>

$V_{(BR)DSS}$	$R_{DS(on)}$ TYP	$I_D$ MAX
25 V	6.5 m $\Omega$ @ 10 V	65 A
	9.7 m $\Omega$ @ 4.5 V	

### N-Channel

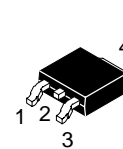
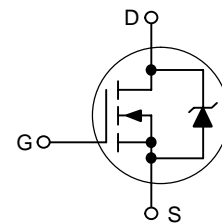

CASE 369AA  
DPAK  
(Bend Lead)  
STYLE 2

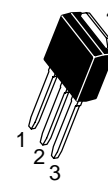

CASE 369D  
DPAK  
(Straight Lead)  
STYLE 2

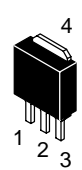

CASE 369AC  
3 IPAK  
(Straight Lead)

### MARKING DIAGRAMS & PIN ASSIGNMENTS

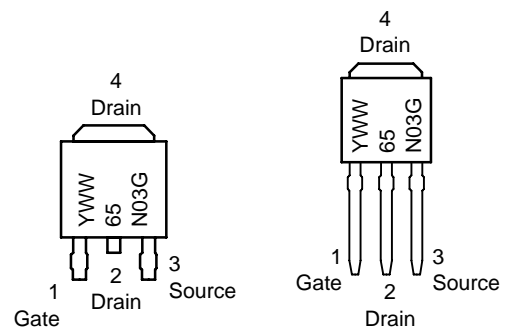

Y = Year  
WW = Work Week  
65N03 = Device Code  
G = Pb-Free Package

### ORDERING INFORMATION

See detailed ordering and shipping information in the package dimensions section on page 5 of this data sheet.

# NTD65N03R

## THERMAL RESISTANCE MAXIMUM RATINGS

Parameter	Symbol	Value	Unit
Junction-to-Case (Drain)	$R_{\theta JC}$	2.5	°C/W
Junction-to-Ambient - Steady State (Note 3)	$R_{\theta JA}$	80	
Junction-to-Ambient - Steady State (Note 4)	$R_{\theta JA}$	115	

## ELECTRICAL CHARACTERISTICS ( $T_J = 25^\circ\text{C}$ unless otherwise noted)

Parameter	Symbol	Test Condition	Min	Typ	Max	Unit
-----------	--------	----------------	-----	-----	-----	------

### OFF CHARACTERISTICS

Drain-to-Source Breakdown Voltage	$V_{(BR)DSS}$	$V_{GS} = 0\text{ V}, I_D = 250\ \mu\text{A}$	25	29.5		V
Drain-to-Source Breakdown Voltage Temperature Coefficient	$V_{(BR)DSS}/T_J$			19.2		mV/°C
Zero Gate Voltage Drain Current	$I_{DSS}$	$V_{GS} = 0\text{ V}, V_{DS} = 20\text{ V}$	$T_J = 25^\circ\text{C}$		1.5	$\mu\text{A}$
			$T_J = 125^\circ\text{C}$		10	
Gate-to-Source Leakage Current	$I_{GSS}$	$V_{DS} = 0\text{ V}, V_{GS} = \pm 20\text{ V}$			$\pm 100$	nA

### ON CHARACTERISTICS (Note 5)

Gate Threshold Voltage	$V_{GS(TH)}$	$V_{GS} = V_{DS}, I_D = 250\ \mu\text{A}$	1.0	1.74	2.0	V
Negative Threshold Temperature Coefficient	$V_{GS(TH)}/T_J$			4.8		mV/°C
Drain-to-Source On Resistance	$R_{DS(on)}$	$V_{GS} = 10\text{ V}, I_D = 30\text{ A}$		6.5	8.4	m $\Omega$
		$V_{GS} = 4.5\text{ V}, I_D = 30\text{ A}$		9.7	14.6	
Forward Transconductance	$g_{FS}$	$V_{DS} = 15\text{ V}, I_D = 15\text{ A}$		27		mHos

### CHARGES, CAPACITANCES AND GATE RESISTANCE

Input Capacitance	$C_{iss}$	$V_{GS} = 0\text{ V}, f = 1.0\text{ MHz}, V_{DS} = 20\text{ V}$		1177	1400	pF
Output Capacitance	$C_{oss}$			555		
Reverse Transfer Capacitance	$C_{rss}$			218		
Total Gate Charge	$Q_{G(TOT)}$	$V_{GS} = 5.0\text{ V}, V_{DS} = 10\text{ V}, I_D = 30\text{ A}$		12.2	16	nC
Threshold Gate Charge	$Q_{G(TH)}$			1.5		
Gate-to-Source Charge	$Q_{GS}$			2.95		
Gate-to-Drain Charge	$Q_{GD}$			6.08		

### SWITCHING CHARACTERISTICS (Note 6)

Turn-On Delay Time	$t_{d(on)}$	$V_{GS} = 10\text{ V}, V_{DS} = 25\text{ V}, I_D = 30\text{ A}, R_G = 3.0\ \Omega$		6.3		ns
Rise Time	$t_r$			18.6		
Turn-Off Delay Time	$t_{d(off)}$			20.3		
Fall Time	$t_f$			8.8		

### DRAIN-SOURCE DIODE CHARACTERISTICS

Forward Diode Voltage	$V_{SD}$	$V_{GS} = 0\text{ V}, I_S = 20\text{ A}$	$T_J = 25^\circ\text{C}$	0.85	1.1	V
			$T_J = 125^\circ\text{C}$	0.72		
Reverse Recovery Time	$t_{RR}$	$V_{GS} = 0\text{ V}, di_S/dt = 100\text{ A}/\mu\text{s}, I_S = 20\text{ A}$		28.8		ns
Charge Time	$t_a$			12.8		
Discharge Time	$t_b$			16		
Reverse Recovery Time	$Q_{RR}$			20		nC

### PACKAGE PARASITIC VALUES

Source Inductance	$L_S$	$T_A = 25^\circ\text{C}$		2.49		nH
Drain Inductance	$L_D$			0.02		
Gate Inductance	$L_G$			3.46		
Gate Resistance	$R_G$			1.75		

- Surface-mounted on FR4 board using 1 in sq pad size (Cu area = 1.127 in sq [1 oz] including traces).
- Surface-mounted on FR4 board using the minimum recommended pad size (Cu area = 0.15 in sq [1 oz] including traces).
- Pulse Test: Pulse Width  $\leq 300\ \mu\text{s}$ , Duty Cycle  $\leq 2\%$ .
- Switching characteristics are independent of operating junction temperatures.

# NTD65N03R

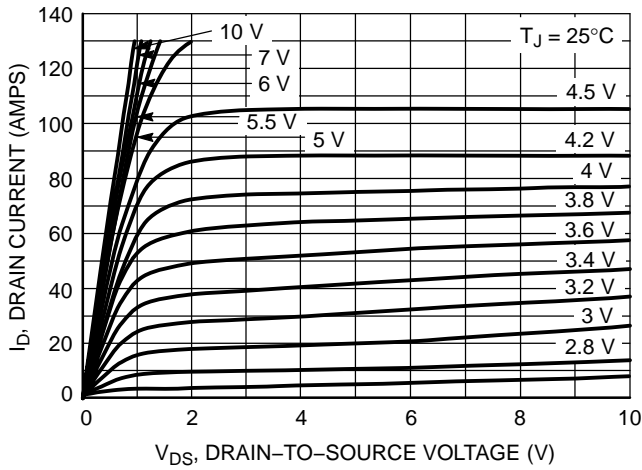

**Figure 1. On-Region Characteristics**

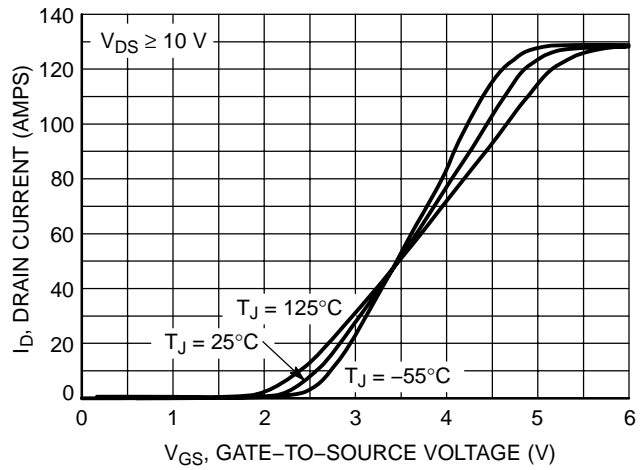

**Figure 2. Transfer Characteristics**

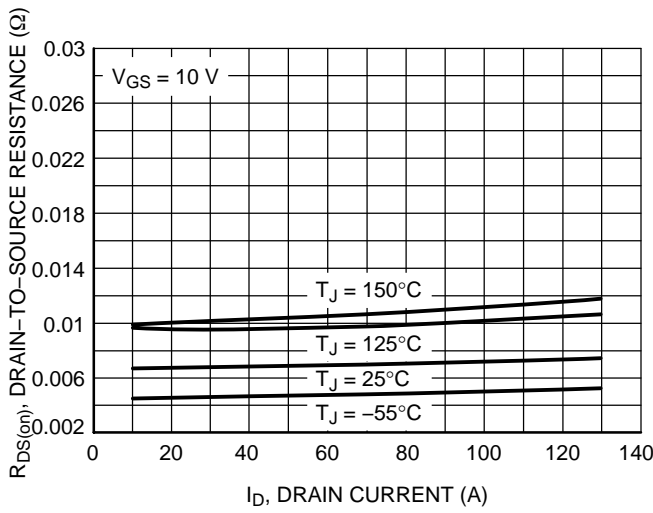

**Figure 3. On-Resistance versus Drain Current and Temperature**

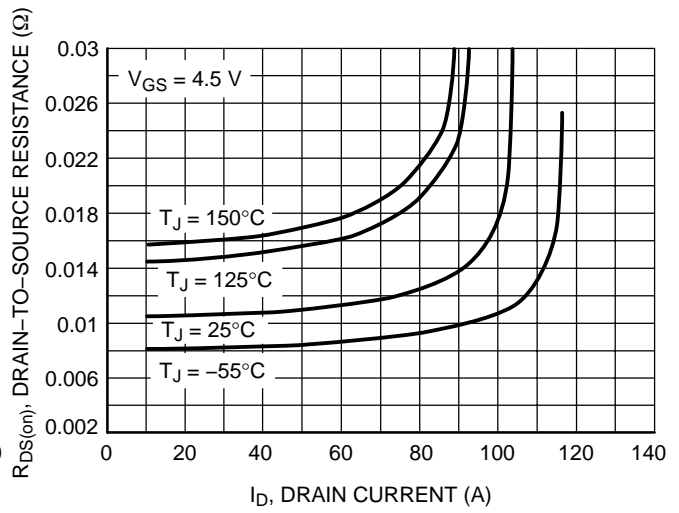

**Figure 4. On-Resistance versus Drain Current and Temperature**

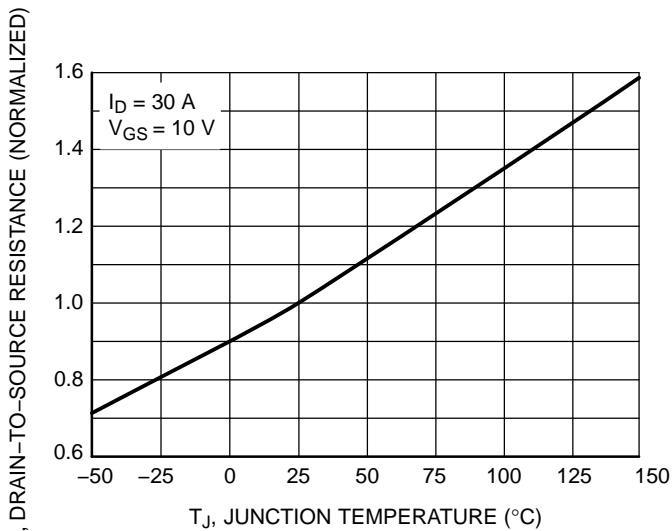

**Figure 5. On-Resistance Variation with Temperature**

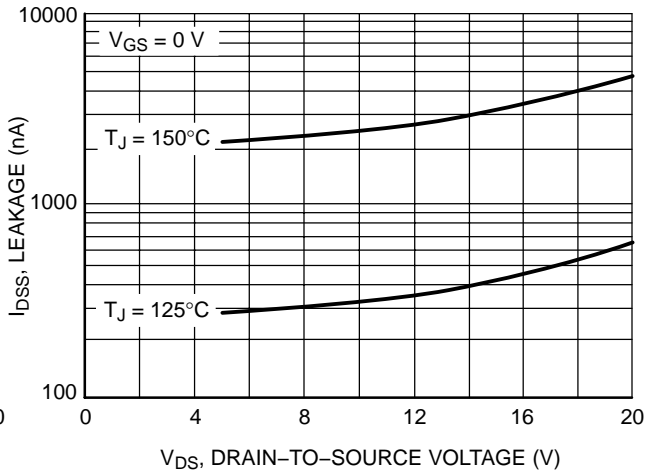

**Figure 6. Drain-to-Source Leakage Current versus Voltage**

# NTD65N03R

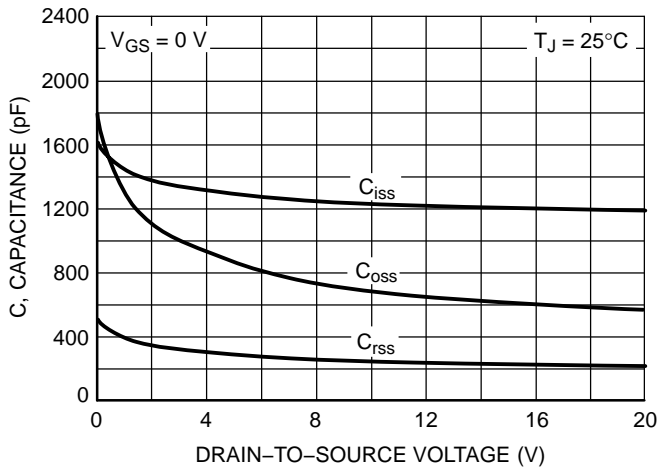

Figure 7. Capacitance Variation

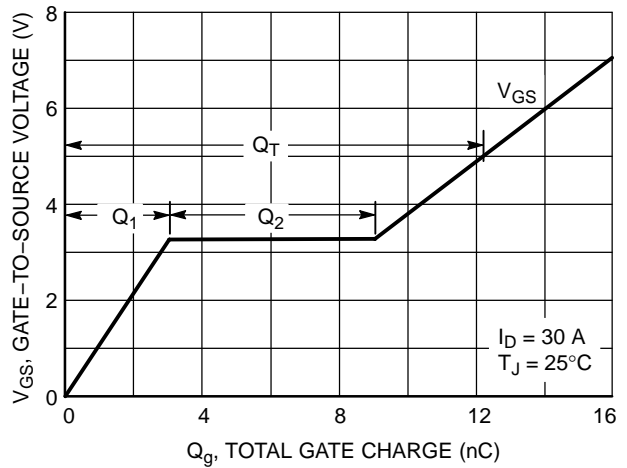

Figure 8. Gate-to-Source and Drain-to-Source Voltage versus Total Charge

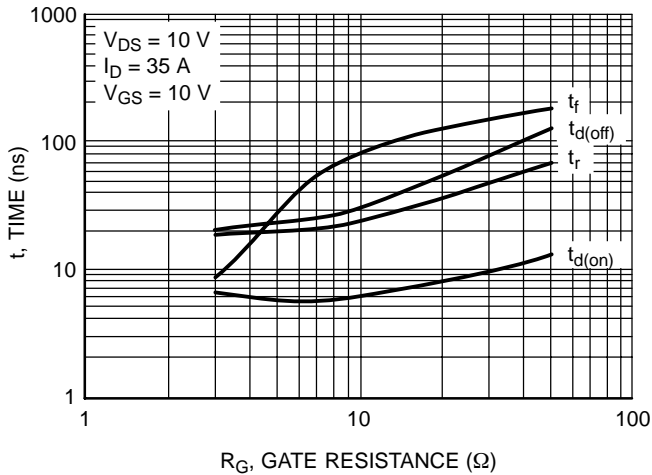

Figure 9. Resistive Switching Time Variation versus Gate Resistance

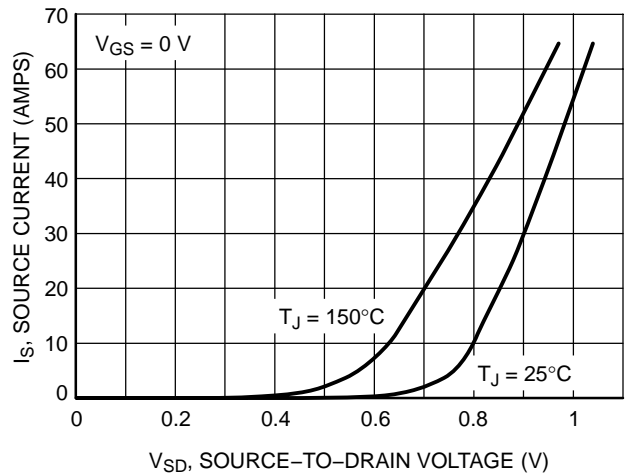

Figure 10. Diode Forward Voltage versus Current

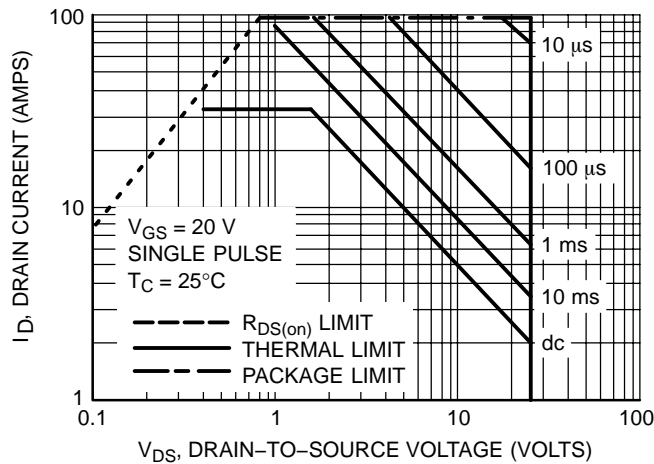

Figure 11. Maximum Rated Forward Biased Safe Operating Area

# NTD65N03R

## ORDERING INFORMATION

Order Number	Package	Shipping†
NTD65N03R	DPAK-3	75 Units / Rail
NTD65N03RG	DPAK-3 (Pb-Free)	75 Units / Rail
NTD65N03RT4	DPAK-3	2500 / Tape & Reel
NTD65N03RT4G	DPAK-3 (Pb-Free)	2500 / Tape & Reel
NTD65N03R-1	DPAK-3 Straight Lead	75 Units / Rail
NTD65N03R-1G	DPAK-3 Straight Lead (Pb-Free)	75 Units / Rail
NTD65N03R-35	DPAK Straight Lead Trimmed (3.5 ± 0.15 mm)	75 Units / Rail
NTD65N03R-35G	DPAK Straight Lead Trimmed (3.5 ± 0.15 mm) (Pb-Free)	75 Units / Rail

†For information on tape and reel specifications, including part orientation and tape sizes, please refer to our Tape and Reel Packaging Specifications Brochure, BRD8011/D.

# NTD65N03R

## PACKAGE DIMENSIONS

DPAK (SINGLE GAUGE)  
CASE 369AA-01  
ISSUE A

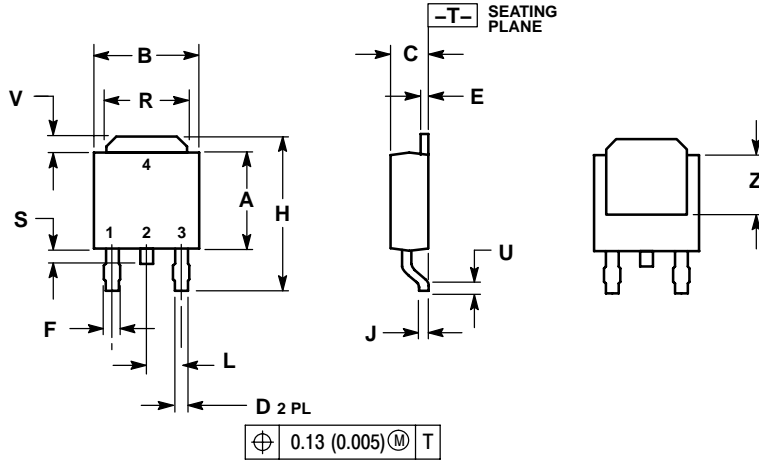

- NOTES:  
1. DIMENSIONING AND TOLERANCING PER ANSI Y14.5M, 1982.  
2. CONTROLLING DIMENSION: INCH.

DIM	INCHES		MILLIMETERS	
	MIN	MAX	MIN	MAX
A	0.235	0.245	5.97	6.22
B	0.250	0.265	6.35	6.73
C	0.086	0.094	2.19	2.38
D	0.025	0.035	0.63	0.89
E	0.018	0.024	0.46	0.61
F	0.030	0.045	0.77	1.14
H	0.386	0.410	9.80	10.40
J	0.018	0.023	0.46	0.58
L	0.090 BSC		2.29 BSC	
R	0.180	0.215	4.57	5.45
S	0.024	0.040	0.60	1.01
U	0.020	---	0.51	---
V	0.035	0.050	0.89	1.27
Z	0.155	---	3.93	---

STYLE 2:  
PIN 1. GATE  
2. DRAIN  
3. SOURCE  
4. DRAIN

### SOLDERING FOOTPRINT\*

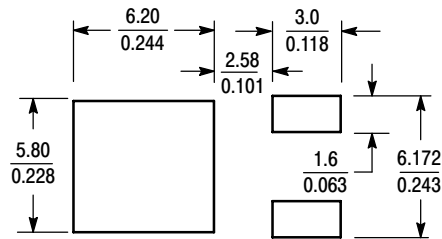

SCALE 3:1  $\left( \frac{\text{mm}}{\text{inches}} \right)$

\*For additional information on our Pb-Free strategy and soldering details, please download the ON Semiconductor Soldering and Mounting Techniques Reference Manual, SOLDERRM/D.

# NTD65N03R

## PACKAGE DIMENSIONS

DPAK  
CASE 369D-01  
ISSUE B

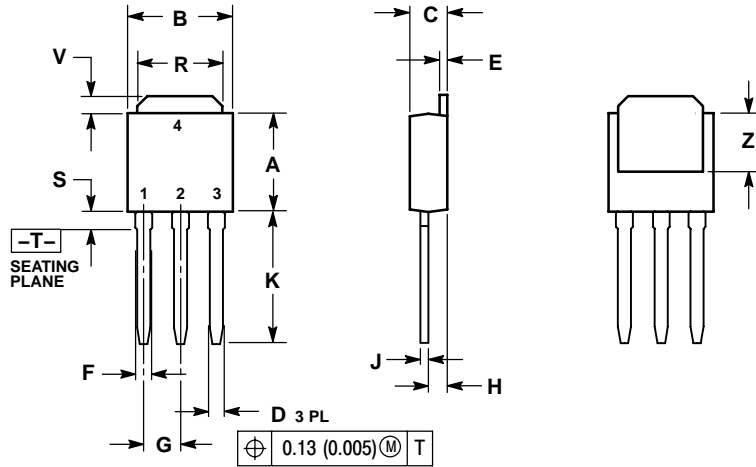

NOTES:

1. DIMENSIONING AND TOLERANCING PER ANSI Y14.5M, 1982.
2. CONTROLLING DIMENSION: INCH.

DIM	INCHES		MILLIMETERS	
	MIN	MAX	MIN	MAX
A	0.235	0.245	5.97	6.35
B	0.250	0.265	6.35	6.73
C	0.086	0.094	2.19	2.38
D	0.027	0.035	0.69	0.88
E	0.018	0.023	0.46	0.58
F	0.037	0.045	0.94	1.14
G	0.090 BSC		2.29 BSC	
H	0.034	0.040	0.87	1.01
J	0.018	0.023	0.46	0.58
K	0.350	0.380	8.89	9.65
R	0.180	0.215	4.45	5.45
S	0.025	0.040	0.63	1.01
V	0.035	0.050	0.89	1.27
Z	0.155	---	3.93	---

STYLE 2:

- PIN 1. GATE
2. DRAIN
3. SOURCE
4. DRAIN

3 IPAK, STRAIGHT LEAD  
CASE 369AC-01  
ISSUE O

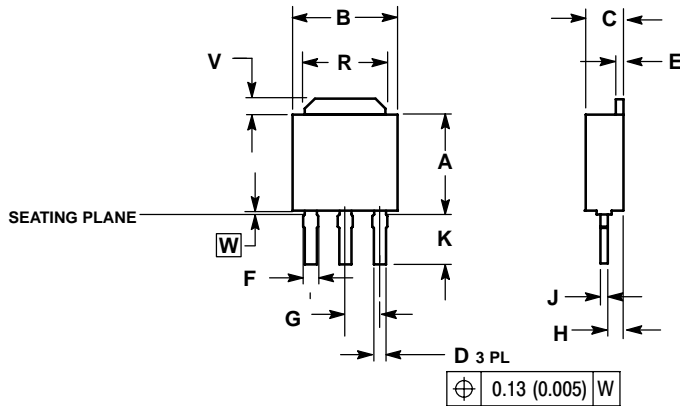

NOTES:

1. DIMENSIONING AND TOLERANCING PER ANSI Y14.5M, 1982.
2. CONTROLLING DIMENSION: INCH.
3. SEATING PLANE IS ON TOP OF DAMBAR POSITION.
4. DIMENSION A DOES NOT INCLUDE DAMBAR POSITION OR MOLD GATE.

DIM	INCHES		MILLIMETERS	
	MIN	MAX	MIN	MAX
A	0.235	0.245	5.97	6.22
B	0.250	0.265	6.35	6.73
C	0.086	0.094	2.19	2.38
D	0.027	0.035	0.69	0.88
E	0.018	0.023	0.46	0.58
F	0.037	0.043	0.94	1.09
G	0.090 BSC		2.29 BSC	
H	0.034	0.040	0.87	1.01
J	0.018	0.023	0.46	0.58
K	0.134	0.142	3.40	3.60
R	0.180	0.215	4.57	5.46
V	0.035	0.050	0.89	1.27
W	0.000	0.010	0.000	0.25

# NTD65N03R

**ON Semiconductor** and **ON** are registered trademarks of Semiconductor Components Industries, LLC (SCILLC). SCILLC reserves the right to make changes without further notice to any products herein. SCILLC makes no warranty, representation or guarantee regarding the suitability of its products for any particular purpose, nor does SCILLC assume any liability arising out of the application or use of any product or circuit, and specifically disclaims any and all liability, including without limitation special, consequential or incidental damages. "Typical" parameters which may be provided in SCILLC data sheets and/or specifications can and do vary in different applications and actual performance may vary over time. All operating parameters, including "Typicals" must be validated for each customer application by customer's technical experts. SCILLC does not convey any license under its patent rights nor the rights of others. SCILLC products are not designed, intended, or authorized for use as components in systems intended for surgical implant into the body, or other applications intended to support or sustain life, or for any other application in which the failure of the SCILLC product could create a situation where personal injury or death may occur. Should Buyer purchase or use SCILLC products for any such unintended or unauthorized application, Buyer shall indemnify and hold SCILLC and its officers, employees, subsidiaries, affiliates, and distributors harmless against all claims, costs, damages, and expenses, and reasonable attorney fees arising out of, directly or indirectly, any claim of personal injury or death associated with such unintended or unauthorized use, even if such claim alleges that SCILLC was negligent regarding the design or manufacture of the part. SCILLC is an Equal Opportunity/Affirmative Action Employer. This literature is subject to all applicable copyright laws and is not for resale in any manner.

## PUBLICATION ORDERING INFORMATION

### LITERATURE FULFILLMENT:

Literature Distribution Center for ON Semiconductor  
P.O. Box 5163, Denver, Colorado 80217 USA  
**Phone:** 303-675-2175 or 800-344-3860 Toll Free USA/Canada  
**Fax:** 303-675-2176 or 800-344-3867 Toll Free USA/Canada  
**Email:** orderlit@onsemi.com

**N. American Technical Support:** 800-282-9855 Toll Free  
USA/Canada  
**Europe, Middle East and Africa Technical Support:**  
Phone: 421 33 790 2910  
**Japan Customer Focus Center**  
Phone: 81-3-5773-3850

**ON Semiconductor Website:** [www.onsemi.com](http://www.onsemi.com)

**Order Literature:** <http://www.onsemi.com/orderlit>

For additional information, please contact your local Sales Representative

## Looking for pricing, stock, or lifecycle information?

Click below to explore more details on WIN SOURCE:

 [View NTD65N03R-1G on WIN SOURCE](#)

 [ON Semiconductor](#) Information

## Optimize Your Supply Chain with WIN SOURCE Solutions

-  Global Sourcing Solution
-  Obsolete Management
-  Cost Control Management
-  Shortage Management
-  Alternative Solution
-  Excess Inventory Management