



**THE DATASHEET OF
NTD78N03-001**



NTD78N03

Power MOSFET

25 V, 78 A, Single N-Channel, DPAK



ON Semiconductor®

<http://onsemi.com>

Features

- Low $R_{DS(on)}$
- Optimized Gate Charge
- Pb-Free Packages are Available

Applications

- Desktop VCORE
- DC-DC Converters
- Low Side Switch

MAXIMUM RATINGS ($T_J = 25^\circ\text{C}$ unless otherwise noted)

Parameter	Symbol	Value	Unit
Drain-to-Source Voltage	V_{DSS}	25	V
Gate-to-Source Voltage	V_{GS}	± 20	V
Continuous Drain Current (Note 1)	I_D	$T_C = 25^\circ\text{C}$	14.8
		$T_C = 85^\circ\text{C}$	11.5
Power Dissipation (Note 1)	P_D	$T_C = 25^\circ\text{C}$	2.3
Continuous Drain Current (Note 2)	I_D	$T_C = 25^\circ\text{C}$	11.4
		$T_C = 85^\circ\text{C}$	8.8
Power Dissipation (Note 2)	P_D	$T_C = 25^\circ\text{C}$	1.4
Continuous Drain Current ($R_{\theta JC}$)	I_D	$T_C = 25^\circ\text{C}$	78
		$T_C = 85^\circ\text{C}$	56
Power Dissipation ($R_{\theta JC}$)	P_D	$T_C = 25^\circ\text{C}$	64
Pulsed Drain Current	$t_p = 10 \mu\text{s}$	I_{DM}	210
Current Limited by Package	$T_A = 25^\circ\text{C}$	$I_{DmaxPkg}$	45
Drain to Source dV/dt	dV/dt	8.0	V/ns
Operating Junction and Storage Temperature	T_J, T_{stg}	-55 to 175	$^\circ\text{C}$
Source Current (Body Diode)	I_S	78	A
Single Pulse Drain-to-Source Avalanche Energy ($V_{DD} = 24 \text{ V}$, $V_{GS} = 10 \text{ V}$, $L = 5.0 \text{ mH}$, $I_L(\text{pk}) = 17 \text{ A}$, $R_G = 25 \Omega$)	E_{AS}	722.5	mJ
Lead Temperature for Soldering Purposes (1/8" from case for 10 seconds)	T_L	260	$^\circ\text{C}$

THERMAL RESISTANCE

Junction-to-Case (Drain)	$R_{\theta JC}$	1.95	$^\circ\text{C/W}$
Junction-to-Ambient - Steady State (Note 1)	$R_{\theta JA}$	65	
Junction-to-Ambient - Steady State (Note 2)	$R_{\theta JA}$	110	

Stresses exceeding Maximum Ratings may damage the device. Maximum Ratings are stress ratings only. Functional operation above the Recommended Operating Conditions is not implied. Extended exposure to stresses above the Recommended Operating Conditions may affect device reliability.

1. Surface-mounted on FR4 board using 1 in sq pad size (Cu area = 1.127 in sq [1 oz] including traces).
2. Surface-mounted on FR4 board using the minimum recommended pad size.

$V_{(BR)DSS}$	$R_{DS(on)}$ TYP	I_D MAX
25 V	4.6 @ 10 V	78 A
	6.5 @ 4.5 V	

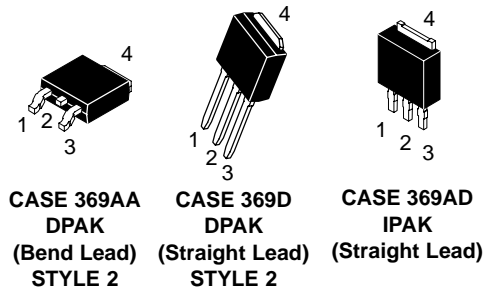
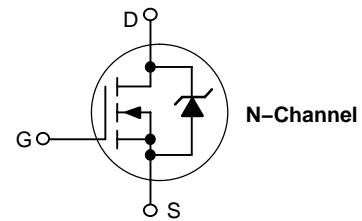

MARKING DIAGRAMS & PIN ASSIGNMENTS

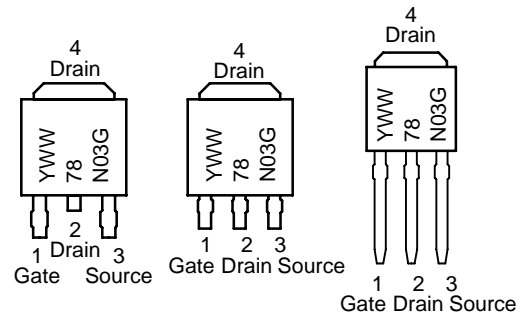

Y = Year
 WW = Work Week
 78N03 = Device Code
 G = Pb-Free Package

ORDERING INFORMATION

See detailed ordering and shipping information in the package dimensions section on page 5 of this data sheet.

NTD78N03

ELECTRICAL CHARACTERISTICS (T_J = 25°C unless otherwise noted)

Parameter	Symbol	Test Condition	Min	Typ	Max	Unit
-----------	--------	----------------	-----	-----	-----	------

OFF CHARACTERISTICS

Drain-to-Source Breakdown Voltage	V _{(BR)DSS}	V _{GS} = 0 V, I _D = 250 μA	25			V
Drain-to-Source Breakdown Voltage Temperature Coefficient	V _{(BR)DSS} /T _J			24		mV/°C
Zero Gate Voltage Drain Current	I _{DSS}	V _{GS} = 0 V, V _{DS} = 20 V	T _J = 25°C		1.5	μA
			T _J = 125°C		10	
Gate-to-Source Leakage Current	I _{GSS}	V _{DS} = 0 V, V _{GS} = ± 20 V			± 100	nA

ON CHARACTERISTICS (Note 3)

Gate Threshold Voltage	V _{GS(TH)}	V _{GS} = V _{DS} , I _D = 250 μA	1.0	1.6	3.0	V
Negative Threshold Temperature Coefficient	V _{GS(TH)} /T _J			-5.0		mV/°C
Drain-to-Source On Resistance	R _{DS(on)}	V _{GS} = 10 V, I _D = 78 A		4.6	6.0	mΩ
		V _{GS} = 4.5 V, I _D = 36 A		6.5	7.8	
Forward Transconductance	g _{FS}	V _{DS} = 10 V, I _D = 15 A		22		S

CHARGES, CAPACITANCES AND GATE RESISTANCE

Input Capacitance	C _{iss}	V _{GS} = 0 V, f = 1.0 MHz, V _{DS} = 12 V		1920	2250	pF
Output Capacitance	C _{oss}			960		
Reverse Transfer Capacitance	C _{rss}			420		
Total Gate Charge	Q _{G(TOT)}	V _{GS} = 4.5 V, V _{DS} = 20 V, I _D = 20 A		25.5	35	nC
Threshold Gate Charge	Q _{G(TH)}			2.4		
Gate-to-Source Charge	Q _{GS}			5.3		
Gate-to-Drain Charge	Q _{GD}			18.2		

SWITCHING CHARACTERISTICS (Note 4)

Turn-On Delay Time	t _{d(on)}	V _{GS} = 4.5 V, V _{DS} = 20 V, I _D = 20 A, R _G = 3.0 Ω		11		ns
Rise Time	t _r			68		
Turn-Off Delay Time	t _{d(off)}			23		
Fall Time	t _f			42		

DRAIN-SOURCE DIODE CHARACTERISTICS

Forward Diode Voltage	V _{SD}	V _{GS} = 0 V, I _S = 20 A	T _J = 25°C		0.83	1.0	V
			T _J = 125°C		0.7		
Reverse Recovery Time	t _{RR}	V _{GS} = 0 V, dI _S /dI _t = 100 A/μs, I _S = 20 A		39		ns	
Charge Time	t _a			17.8			
Discharge Time	t _b			21			
Reverse Recovery Time	Q _{RR}			33		nC	

PACKAGE PARASITIC VALUES

Source Inductance	L _S	T _a = 25C		2.49		nH
Drain Inductance	L _D			0.02		
Gate Inductance	L _G			3.46		
Gate Resistance	R _G			1.0		

3. Pulse Test: Pulse Width ≤ 300 μs, Duty Cycle ≤ 2%.

4. Switching characteristics are independent of operating junction temperatures.

NTD78N03

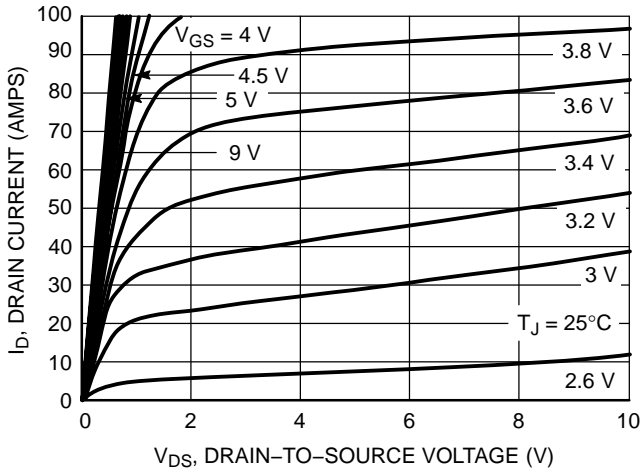

Figure 1. On-Region Characteristics

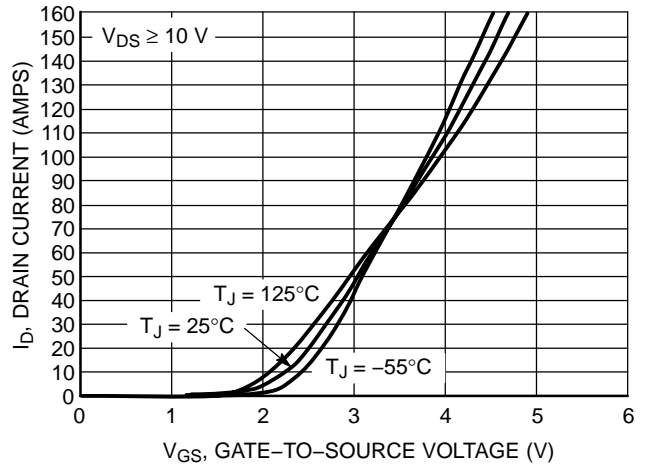

Figure 2. Transfer Characteristics

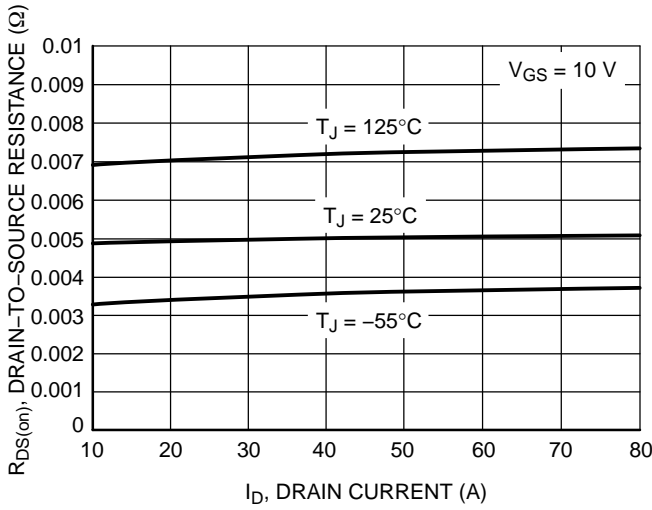

Figure 3. On-Resistance versus Drain Current and Temperature

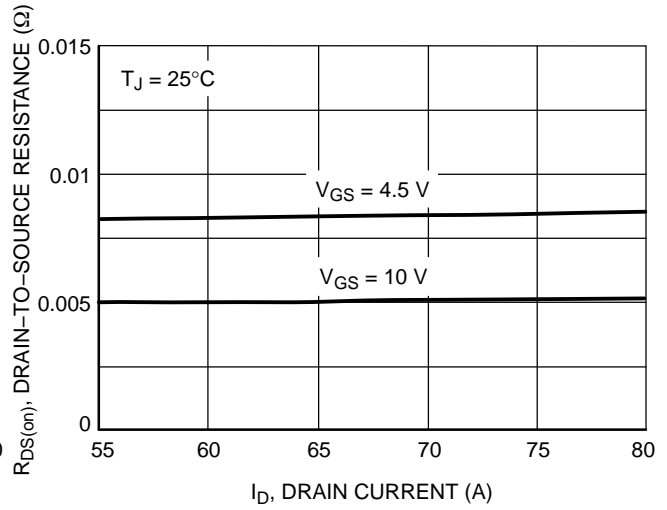

Figure 4. On-Resistance versus Drain Current and Gate Voltage

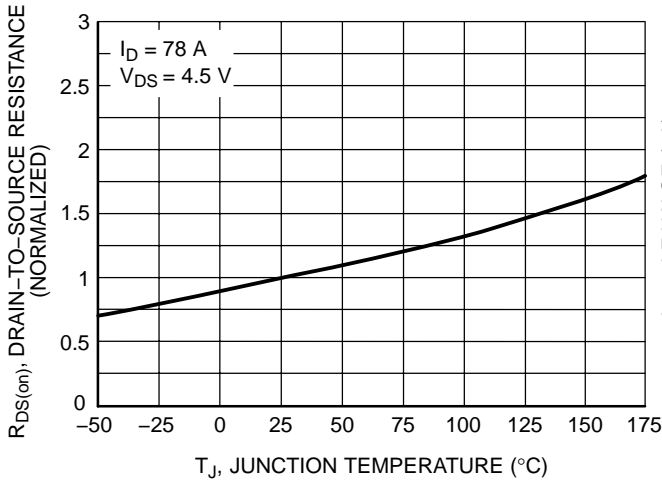

Figure 5. On-Resistance Variation with Temperature

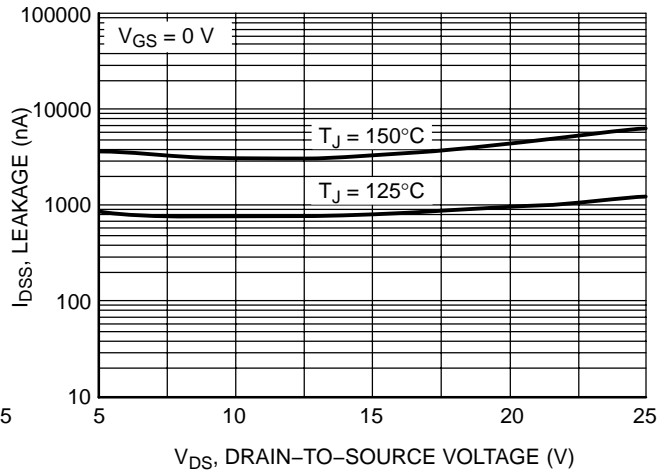
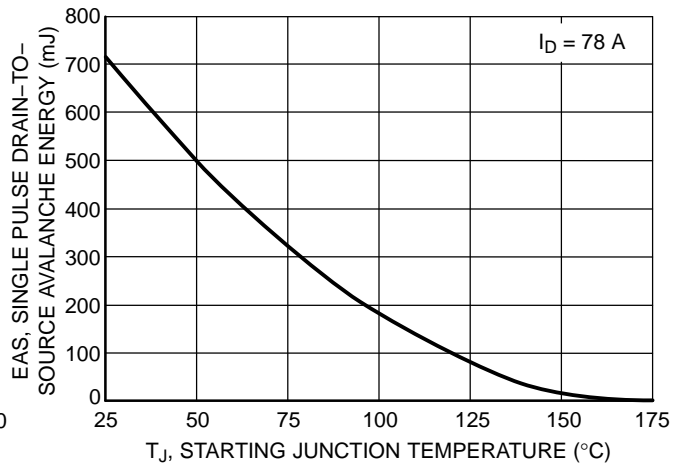
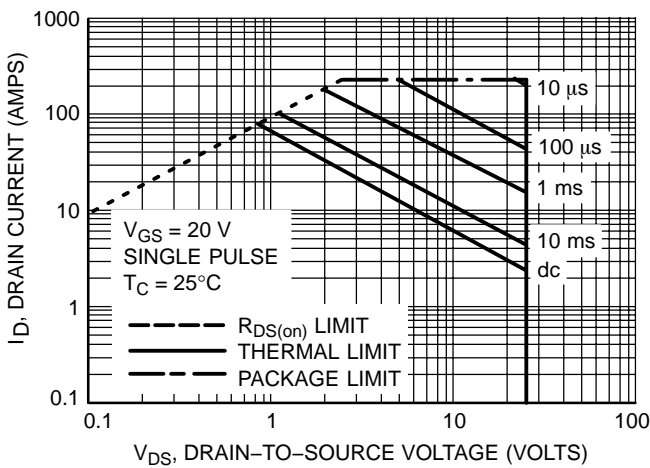
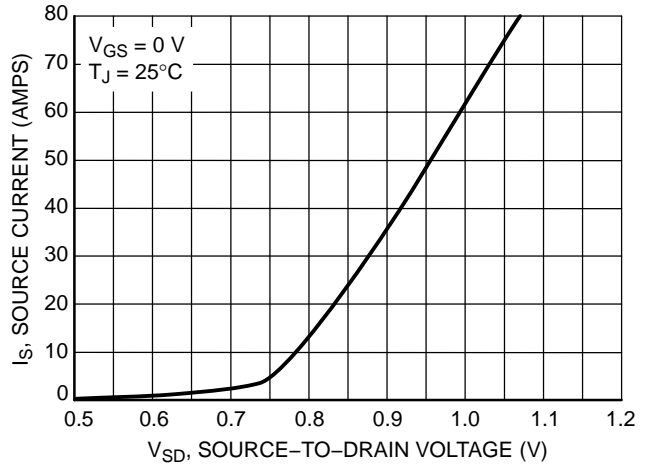
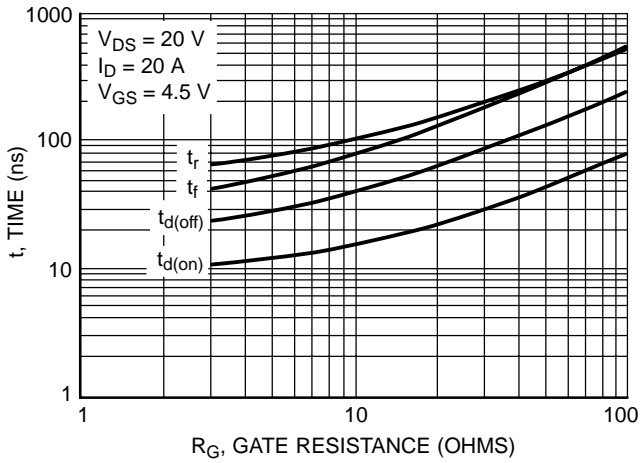
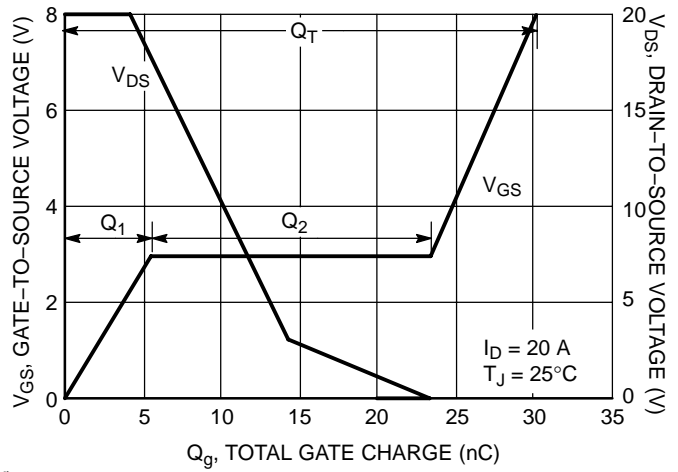
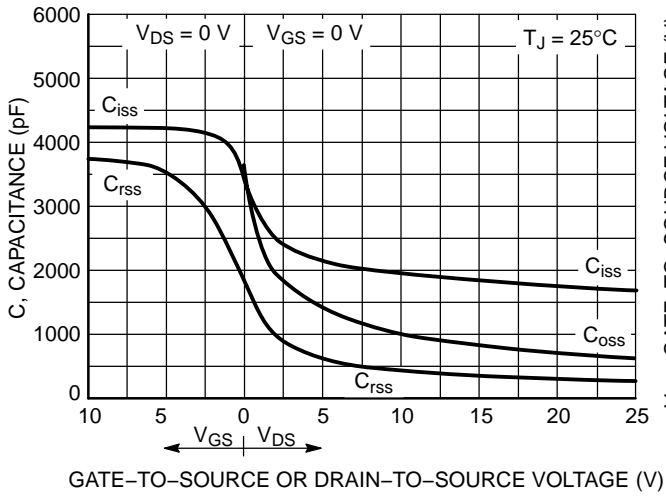

Figure 6. Drain-to-Source Leakage Current versus Voltage

NTD78N03



NTD78N03

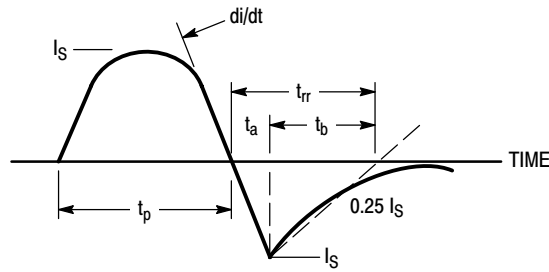

Figure 13. Diode Reverse Recovery Waveform

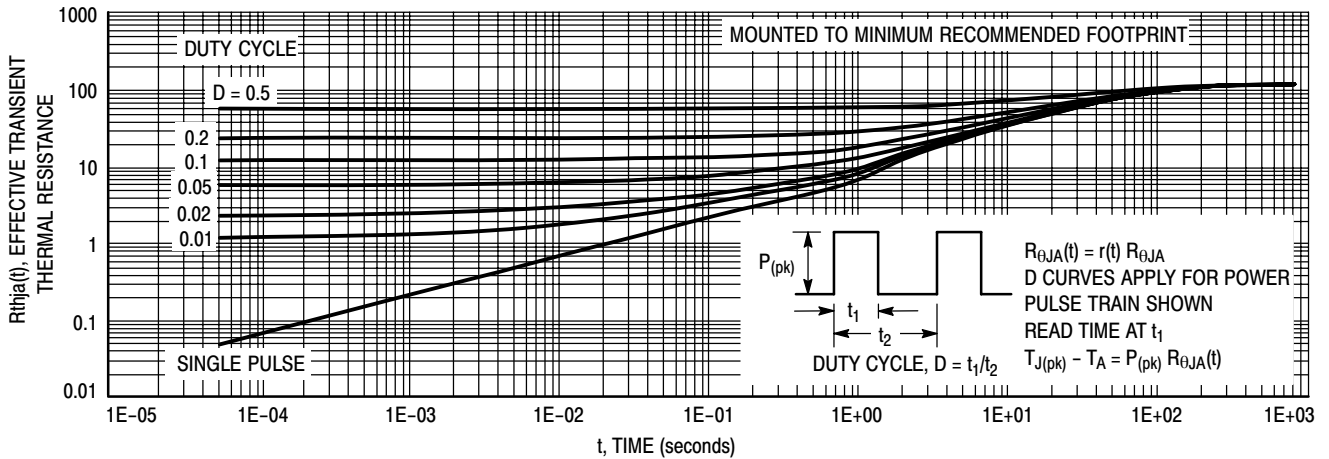

Figure 14. Thermal Response – Various Duty Cycles

ORDERING INFORMATION

Order Number	Package	Shipping†
NTD78N03	DPAK	75 Units/Rail
NTD78N03G	DPAK (Pb-Free)	75 Units/Rail
NTD78N03T4	DPAK	2500 Tape & Reel
NTD78N03T4G	DPAK (Pb-Free)	
NTD78N03-1	DPAK Straight Lead	75 Units/Rail
NTD78N03-1G	DPAK Straight Lead (Pb-Free)	
NTD78N03-35	DPAK-3 Straight Lead (3.5 ± 0.15 mm)	75 Units/Rail
NTD78N03-35G	DPAK-3 Straight Lead (3.5 ± 0.15 mm) (Pb-Free)	

†For information on tape and reel specifications, including part orientation and tape sizes, please refer to our Tape and Reel Packaging Specifications Brochure, BRD8011/D.

NTD78N03

PACKAGE DIMENSIONS

DPAK (SINGLE GAUGE) CASE 369AA-01 ISSUE A

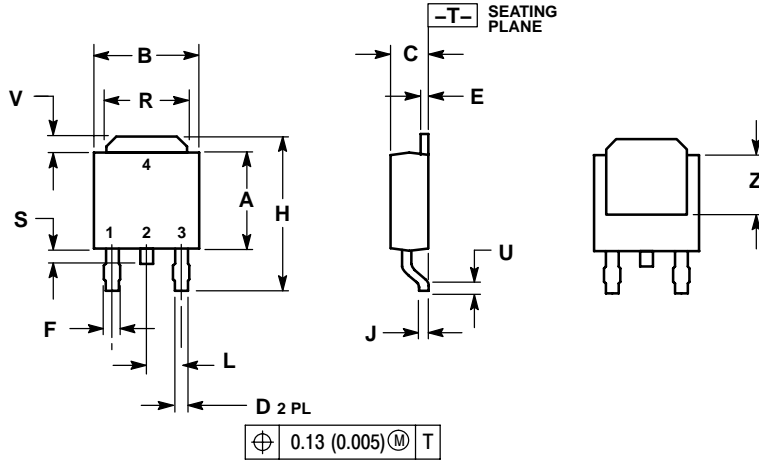

- NOTES:
1. DIMENSIONING AND TOLERANCING PER ANSI Y14.5M, 1982.
2. CONTROLLING DIMENSION: INCH.

DIM	INCHES		MILLIMETERS	
	MIN	MAX	MIN	MAX
A	0.235	0.245	5.97	6.22
B	0.250	0.265	6.35	6.73
C	0.086	0.094	2.19	2.38
D	0.025	0.035	0.63	0.89
E	0.018	0.024	0.46	0.61
F	0.030	0.045	0.77	1.14
H	0.386	0.410	9.80	10.40
J	0.018	0.023	0.46	0.58
L	0.090 BSC		2.29 BSC	
R	0.180	0.215	4.57	5.45
S	0.024	0.040	0.60	1.01
U	0.020	---	0.51	---
V	0.035	0.050	0.89	1.27
Z	0.155	---	3.93	---

- STYLE 2:
PIN 1. GATE
2. DRAIN
3. SOURCE
4. DRAIN

SOLDERING FOOTPRINT*

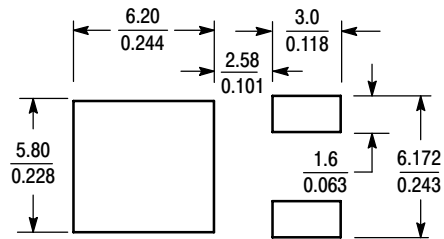

SCALE 3:1 $\left(\frac{\text{mm}}{\text{inches}}\right)$

*For additional information on our Pb-Free strategy and soldering details, please download the ON Semiconductor Soldering and Mounting Techniques Reference Manual, SOLDERRM/D.

NTD78N03

PACKAGE DIMENSIONS

DPAK CASE 369D-01 ISSUE B

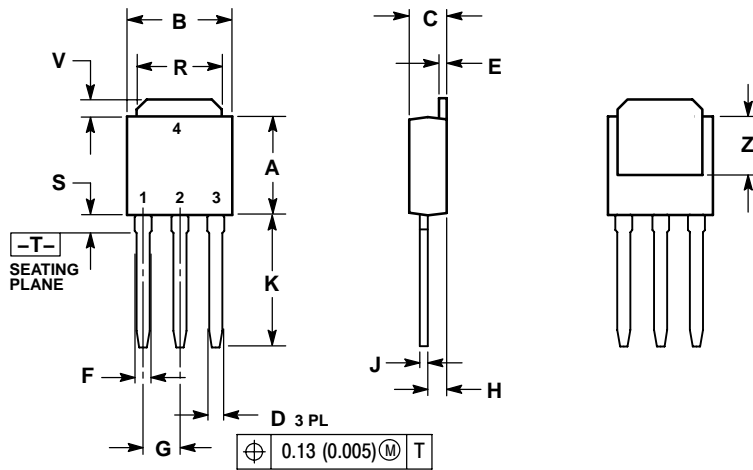

NOTES:

1. DIMENSIONING AND TOLERANCING PER ANSI Y14.5M, 1982.
2. CONTROLLING DIMENSION: INCH.

DIM	INCHES		MILLIMETERS	
	MIN	MAX	MIN	MAX
A	0.235	0.245	5.97	6.35
B	0.250	0.265	6.35	6.73
C	0.086	0.094	2.19	2.38
D	0.027	0.035	0.69	0.88
E	0.018	0.023	0.46	0.58
F	0.037	0.045	0.94	1.14
G	0.090 BSC		2.29 BSC	
H	0.034	0.040	0.87	1.01
J	0.018	0.023	0.46	0.58
K	0.350	0.380	8.89	9.65
R	0.180	0.215	4.45	5.45
S	0.025	0.040	0.63	1.01
V	0.035	0.050	0.89	1.27
Z	0.155	---	3.93	---

STYLE 2:

- PIN 1. GATE
2. DRAIN
3. SOURCE
4. DRAIN

3.5 MM IPAK, STRAIGHT LEAD CASE 369AD-01 ISSUE O

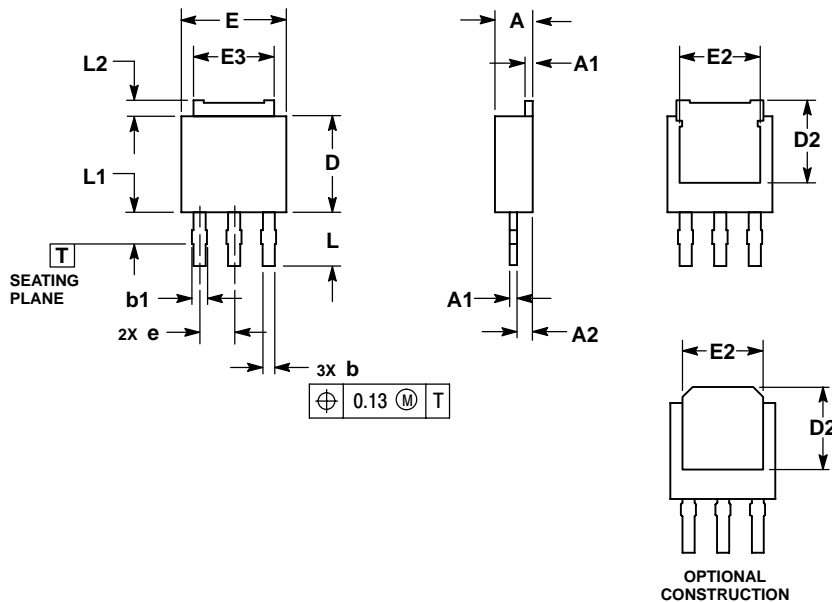

NOTES:

- 1.. DIMENSIONING AND TOLERANCING PER ASME Y14.5M, 1994.
- 2.. CONTROLLING DIMENSION: MILLIMETERS.
3. DIMENSION b APPLIES TO PLATED TERMINAL AND IS MEASURED BETWEEN 0.15 AND 0.30mm FROM TERMINAL TIP.
4. DIMENSIONS D AND E DO NOT INCLUDE MOLD GATE OR MOLD FLASH.

DIM	MILLIMETERS	
	MIN	MAX
A	2.19	2.38
A1	0.46	0.60
A2	0.87	1.10
b	0.69	0.89
b1	0.77	1.10
D	5.97	6.22
D2	4.80	---
E	6.35	6.73
E2	4.70	---
E3	4.45	5.46
e	2.28 BSC	
L	3.40	3.60
L1	---	2.10
L2	0.89	1.27

OPTIONAL CONSTRUCTION

ON Semiconductor and ON are registered trademarks of Semiconductor Components Industries, LLC (SCILLC). SCILLC reserves the right to make changes without further notice to any products herein. SCILLC makes no warranty, representation or guarantee regarding the suitability of its products for any particular purpose, nor does SCILLC assume any liability arising out of the application or use of any product or circuit, and specifically disclaims any and all liability, including without limitation special, consequential or incidental damages. "Typical" parameters which may be provided in SCILLC data sheets and/or specifications can and do vary in different applications and actual performance may vary over time. All operating parameters, including "Typicals" must be validated for each customer application by customer's technical experts. SCILLC does not convey any license under its patent rights nor the rights of others. SCILLC products are not designed, intended, or authorized for use as components in systems intended for surgical implant into the body, or other applications intended to support or sustain life, or for any other application in which the failure of the SCILLC product could create a situation where personal injury or death may occur. Should Buyer purchase or use SCILLC products for any such unintended or unauthorized application, Buyer shall indemnify and hold SCILLC and its officers, employees, subsidiaries, affiliates, and distributors harmless against all claims, costs, damages, and expenses, and reasonable attorney fees arising out of, directly or indirectly, any claim of personal injury or death associated with such unintended or unauthorized use, even if such claim alleges that SCILLC was negligent regarding the design or manufacture of the part. SCILLC is an Equal Opportunity/Affirmative Action Employer. This literature is subject to all applicable copyright laws and is not for resale in any manner.

PUBLICATION ORDERING INFORMATION

LITERATURE FULFILLMENT:

Literature Distribution Center for ON Semiconductor
P.O. Box 5163, Denver, Colorado 80217 USA
Phone: 303-675-2175 or 800-344-3860 Toll Free USA/Canada
Fax: 303-675-2176 or 800-344-3867 Toll Free USA/Canada
Email: orderlit@onsemi.com

N. American Technical Support: 800-282-9855 Toll Free
USA/Canada
Europe, Middle East and Africa Technical Support:
Phone: 421 33 790 2910
Japan Customer Focus Center
Phone: 81-3-5773-3850

ON Semiconductor Website: www.onsemi.com

Order Literature: <http://www.onsemi.com/orderlit>

For additional information, please contact your local Sales Representative

Looking for pricing, stock, or lifecycle information?

Click below to explore more details on WIN SOURCE:

 [View NTD78N03-001](#) on WIN SOURCE

 [ON Semiconductor](#) Information

Optimize Your Supply Chain with WIN SOURCE Solutions

-  Global Sourcing Solution
-  Obsolete Management
-  Cost Control Management
-  Shortage Management
-  Alternative Solution
-  Excess Inventory Management