



BXL4004

N-Channel Power MOSFET 40V, 100A, 3.9mΩ, TO-220-3L

ON Semiconductor®

<http://onsemi.com>

Features

- ON-resistance $R_{DS(on)} = 3.9\text{m}\Omega$ (typ.)
- Input capacitance $C_{iss} = 8200\text{pF}$ (typ.)
- 4.5V drive

Specifications

Absolute Maximum Ratings at $T_a = 25^\circ\text{C}$

Parameter	Symbol	Conditions	Ratings	Unit
Drain-to-Source Voltage	V_{DSS}		40	V
Gate-to-Source Voltage	V_{GSS}		± 20	V
Drain Current (DC)	I_D		100	A
Drain Current (Pulse)	I_{DP}	$PW \leq 10\mu\text{s}$, duty cycle $\leq 1\%$	400	A
Allowable Power Dissipation	P_D		1.75	W
		$T_c = 25^\circ\text{C}$	75	W
Channel Temperature	T_{ch}		150	$^\circ\text{C}$
Storage Temperature	T_{stg}		-55 to +150	$^\circ\text{C}$
Avalanche Energy (Single Pulse) *1	E_{AS}		420	mJ
Avalanche Current *2	I_{AV}		60	A

Note : *1 $V_{DD} = 24\text{V}$, $L = 100\mu\text{H}$, $I_{AV} = 60\text{A}$ (Fig.1)

*2 $L \leq 100\mu\text{H}$, Single pulse

Stresses exceeding Maximum Ratings may damage the device. Maximum Ratings are stress ratings only. Functional operation above the Recommended Operating Conditions is not implied. Extended exposure to stresses above the Recommended Operating Conditions may affect device reliability.

Package Dimensions

unit : mm (typ)

7536-001

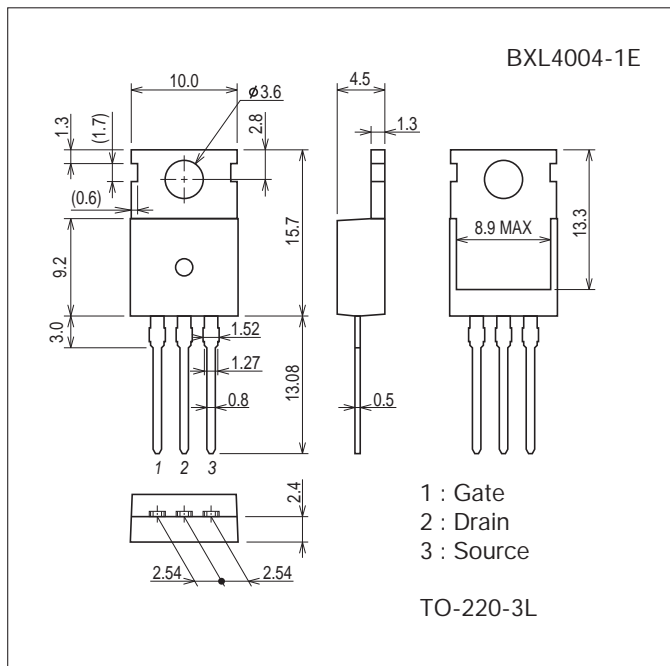

Product & Package Information

- Package : TO-220-3L
- JEITA, JEDEC : SC-46, TO-220AB
- Minimum Packing Quantity : 50 pcs./magazine

Marking

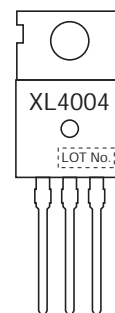

Electrical Connection

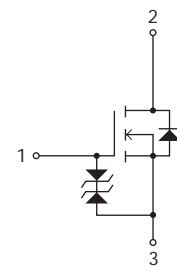

BXL4004

Electrical Characteristics at Ta=25°C

Parameter	Symbol	Conditions	Ratings			Unit
			min	typ	max	
Drain-to-Source Breakdown Voltage	V(BR)DSS	I _D =1mA, V _{GS} =0V	40			V
Zero-Gate Voltage Drain Current	I _{DSS}	V _{DS} =40V, V _{GS} =0V			10	μA
Gate-to-Source Leakage Current	I _{GSS}	V _{GS} =±16V, V _{DS} =0V			±10	μA
Cutoff Voltage	V _{GS(off)}	V _{DS} =10V, I _D =1mA	1.2		2.6	V
Forward Transfer Admittance	y _{fs}	V _{DS} =10V, I _D =50A		120		S
Static Drain-to-Source On-State Resistance	R _{DS(on)1}	I _D =50A, V _{GS} =10V		3	3.9	mΩ
	R _{DS(on)2}	I _D =50A, V _{GS} =4.5V		4.7	6.6	mΩ
Input Capacitance	C _{iss}	V _{DS} =20V, f=1MHz		8200		pF
Output Capacitance	C _{oss}			940		pF
Reverse Transfer Capacitance	C _{rss}			700		pF
Turn-ON Delay Time	t _{d(on)}			65		ns
Rise Time	t _r	See Fig.2		390		ns
Turn-OFF Delay Time	t _{d(off)}			510		ns
Fall Time	t _f			360		ns
Total Gate Charge	Q _g			140		nC
Gate-to-Source Charge	Q _{gs}	V _{DS} =24V, V _{GS} =10V, I _D =100A		43		nC
Gate-to-Drain "Miller" Charge	Q _{gd}			25		nC
Diode Forward Voltage	V _{SD}		I _S =100A, V _{GS} =0V		1.0	1.2
Reverse Recovery Time	t _{rr}	See Fig.3		90		ns
Reverse Recovery Charge	Q _{rr}		I _S =100A, V _{GS} =0V, di/dt=100A/μs		230	

Fig.1 Unclamped Inductive Switching Test Circuit

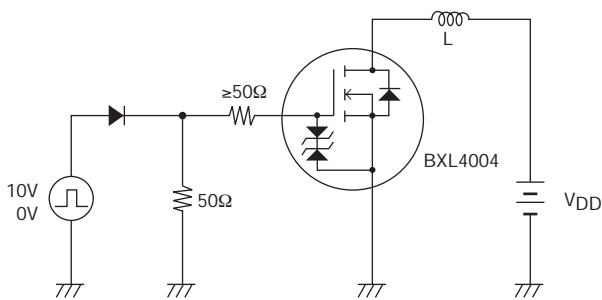

Fig.2 Switching Time Test Circuit

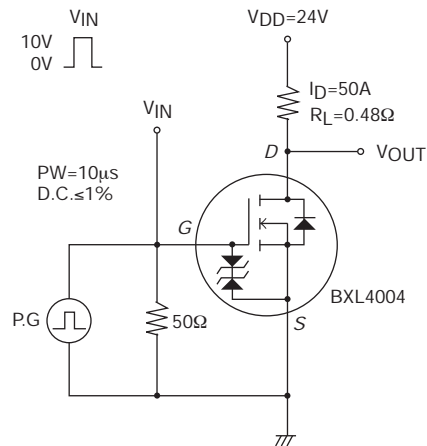
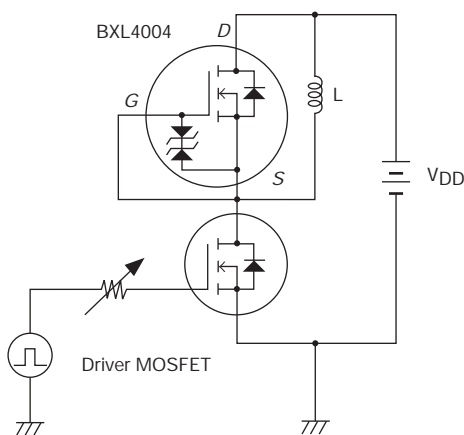
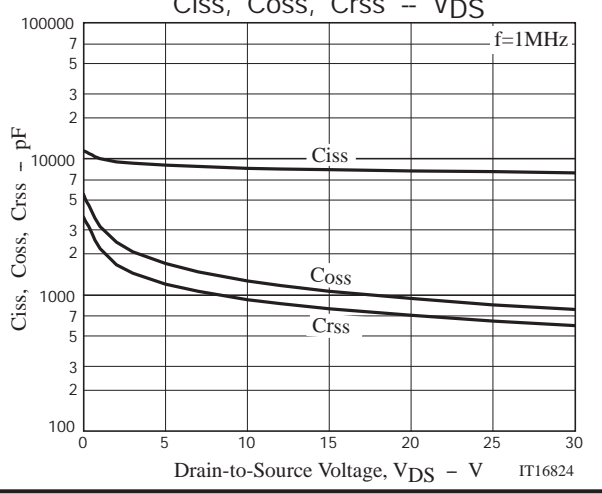
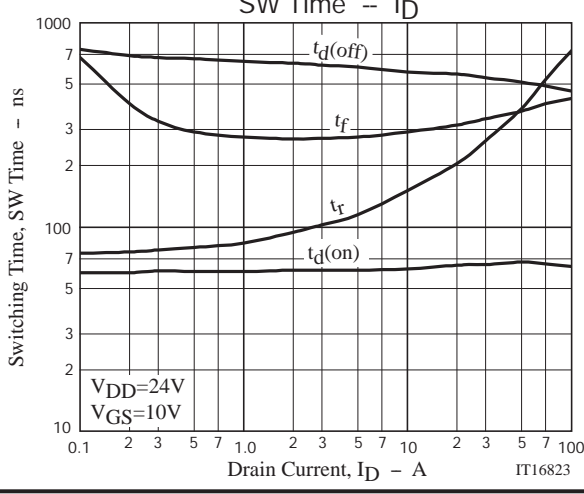
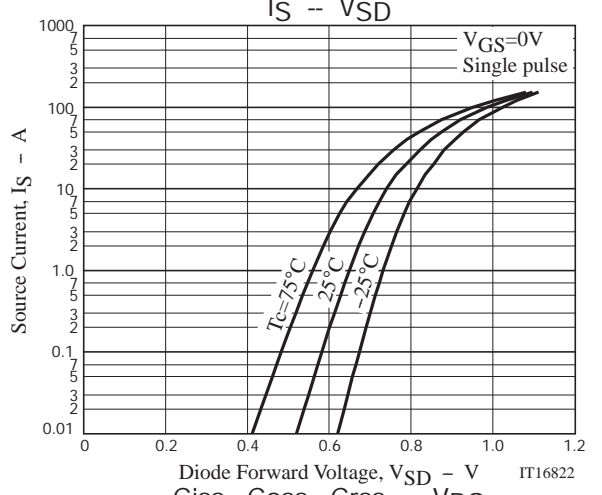
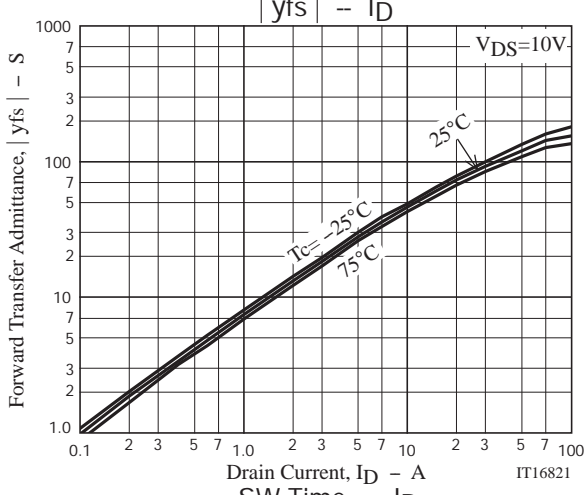
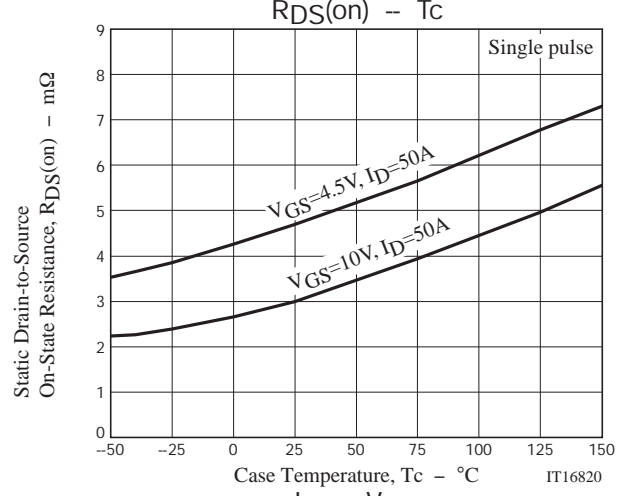
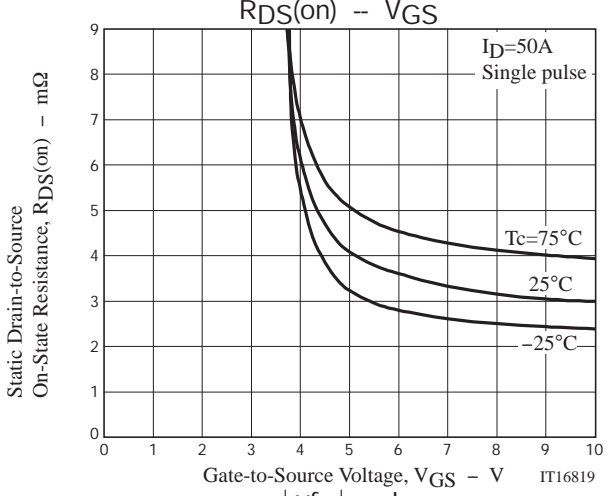
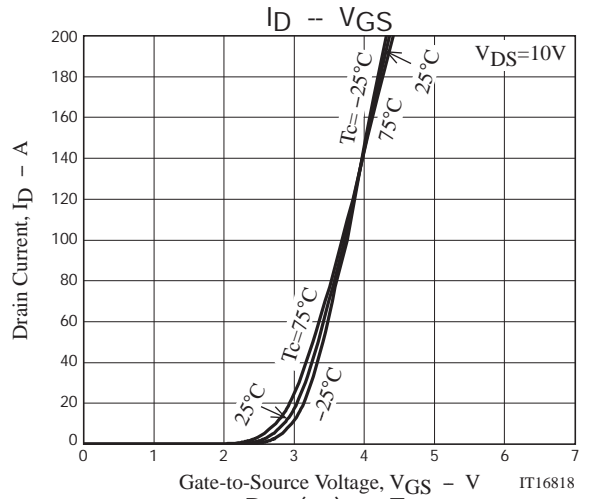
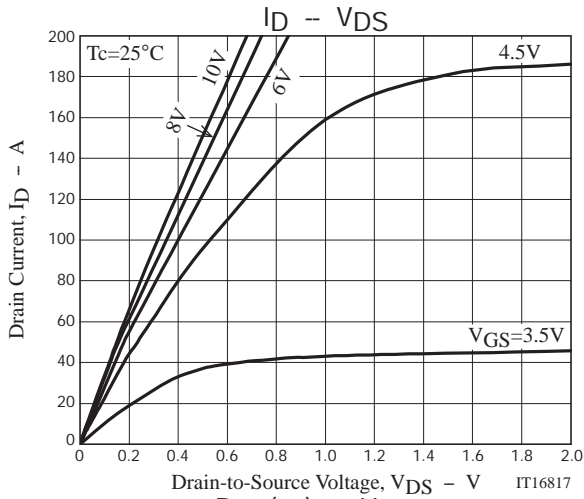

Fig.3 Reverse Recovery Time Test Circuit



Ordering Information

Device	Package	Shipping	memo
BXL4004-1E	TO-220-3L	50pcs./magazine	Pb Free and Halogen Free



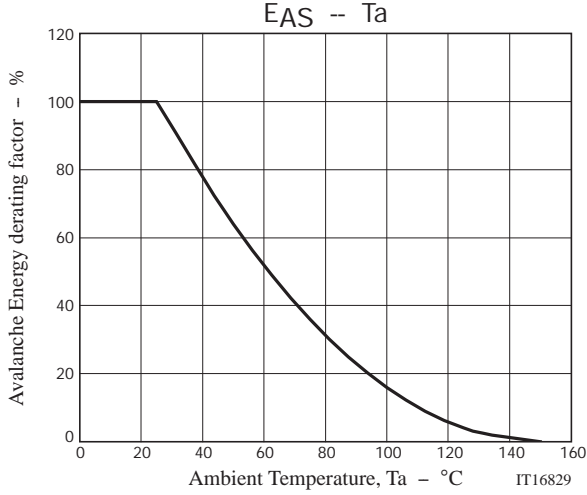
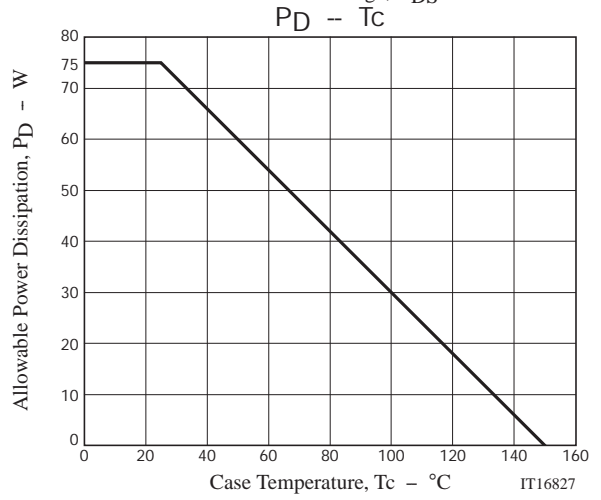
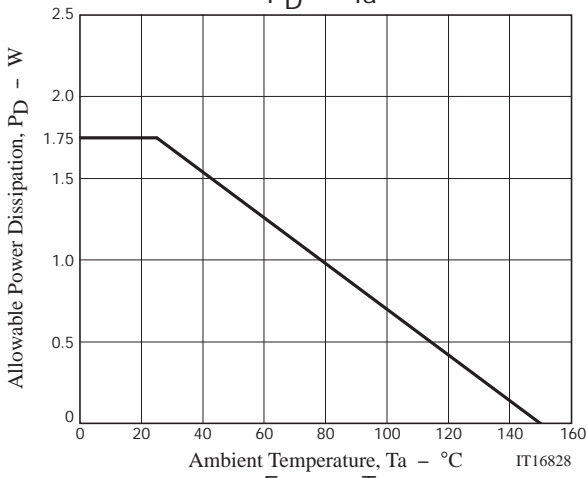
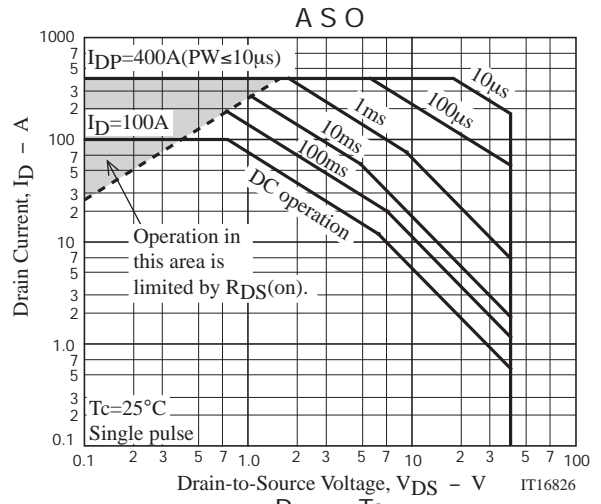
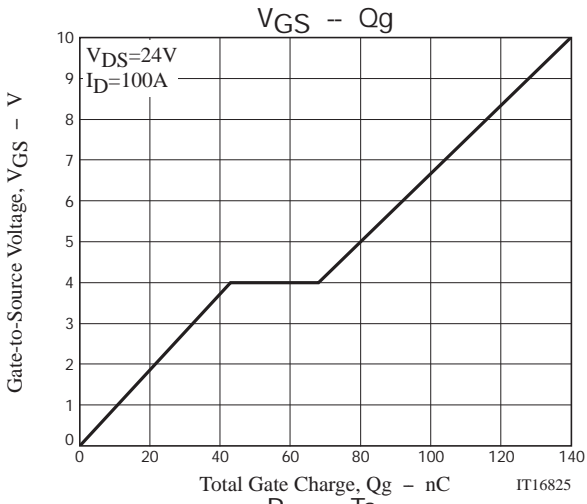

Magazine Specification

BXL4004-1E

1. Packing Format

Package Name	Maximum Number of devices contained (pcs)			Packing format	
	Magazine	Inner box	Outer box	Inner BOX	Outer BOX
TO-220-3L	50	1,000	4000	SPD-0V0001 20 magazines contained Dimensions:mm (external) 568×150×55	SPD-LV0010 4 inner boxes contained Dimensions:mm (external) 590×225×178

2. Magazine dimensions

(unit:mm)

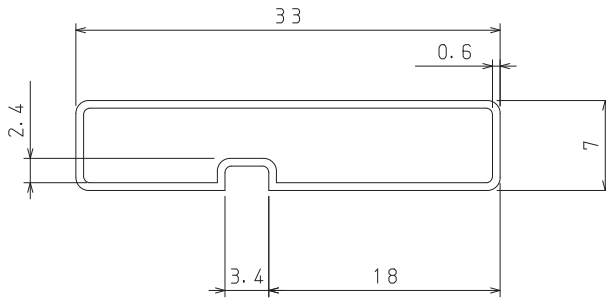

Tolerance=±0.2mm
 Thickness=0.6+0.2/-0mm
 Length =512.6±1mm
 Material =PVC (Antistatic treatment)

3. Storage method to magazine

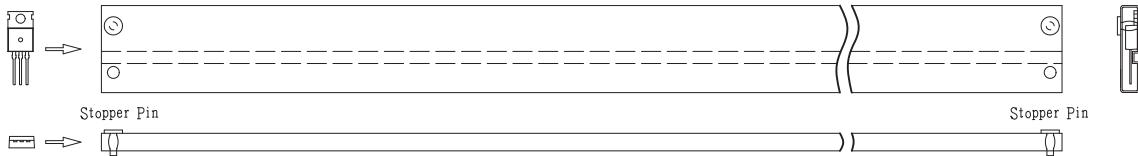

4. Inner box label (unit:mm)

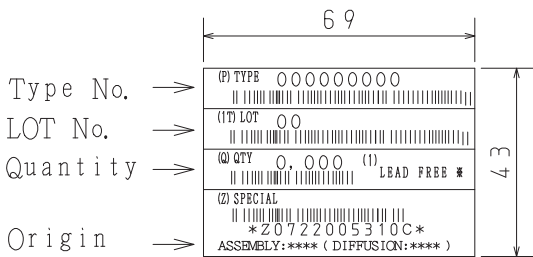

5. Outer box label (unit:mm)

It is a label at the time of factory shipments.
 The form of a label may change in physical distribution process.

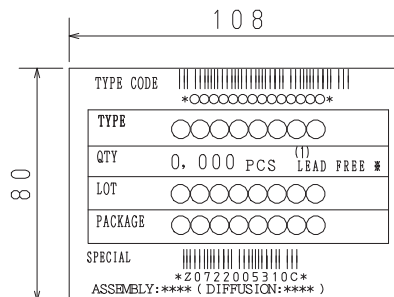

NOTE (1)

The LEAD FREE * description shows that the surface treatment of the terminal is lead free,

Label	JEITA Phase
LEAD FREE 3	JEITA Phase 3A

Outline Drawing

BXL4004-1E

Mass (g)	Unit
2.0	mm
* For reference	

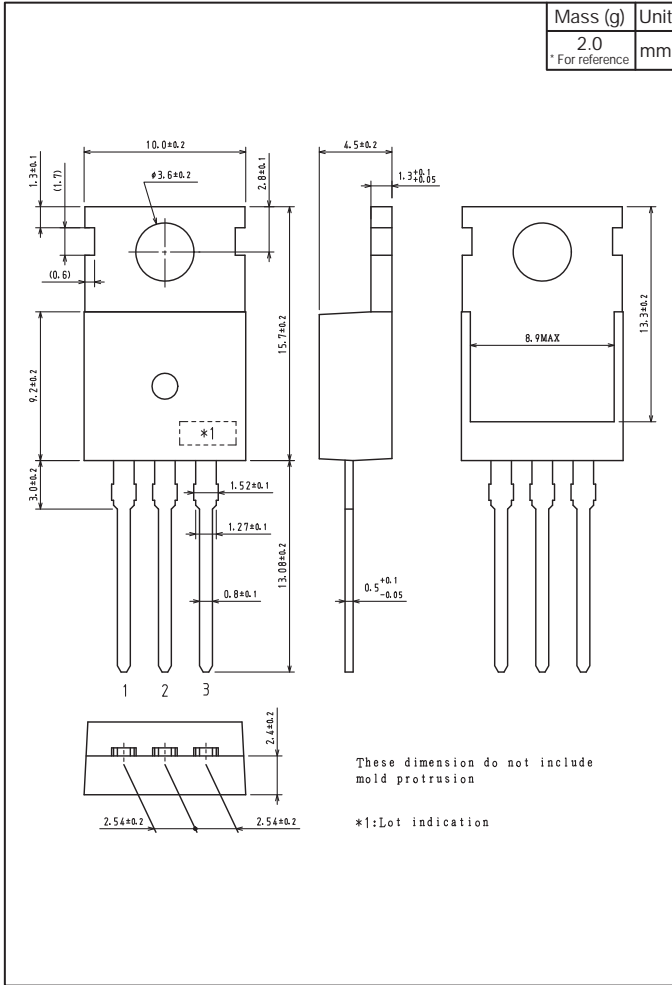



Note on usage : Since the BXL4004 is a MOSFET product, please avoid using this device in the vicinity of highly charged objects.

ON Semiconductor and the ON logo are registered trademarks of Semiconductor Components Industries, LLC (SCILLC). SCILLC owns the rights to a number of patents, trademarks, copyrights, trade secrets, and other intellectual property. A listing of SCILLC's product/patent coverage may be accessed at www.onsemi.com/site/pdf/Patent-Marking.pdf. SCILLC reserves the right to make changes without further notice to any products herein. SCILLC makes no warranty, representation or guarantee regarding the suitability of its products for any particular purpose, nor does SCILLC assume any liability arising out of the application or use of any product or circuit, and specifically disclaims any and all liability, including without limitation special, consequential or incidental damages. "Typical" parameters which may be provided in SCILLC data sheets and/or specifications can and do vary in different applications and actual performance may vary over time. All operating parameters, including "Typicals" must be validated for each customer application by customer's technical experts. SCILLC does not convey any license under its patent rights nor the rights of others. SCILLC products are not designed, intended, or authorized for use as components in systems intended for surgical implant into the body, or other applications intended to support or sustain life, or for any other application in which the failure of the SCILLC product could create a situation where personal injury or death may occur. Should Buyer purchase or use SCILLC products for any such unintended or unauthorized application, Buyer shall indemnify and hold SCILLC and its officers, employees, subsidiaries, affiliates, and distributors harmless against all claims, costs, damages, and expenses, and reasonable attorney fees arising out of, directly or indirectly, any claim of personal injury or death associated with such unintended or unauthorized use, even if such claim alleges that SCILLC was negligent regarding the design or manufacture of the part. SCILLC is an Equal Opportunity/Affirmative Action Employer. This literature is subject to all applicable copyright laws and is not for resale in any manner.

Looking for pricing, stock, or lifecycle information?

Click below to explore more details on WIN SOURCE:

-  [View BXL4004-1E on WIN SOURCE](#)
-  [ON Semiconductor](#) Information

Optimize Your Supply Chain with WIN SOURCE Solutions

-  Global Sourcing Solution
-  Obsolete Management
-  Cost Control Management
-  Shortage Management
-  Alternative Solution
-  Excess Inventory Management