



**THE DATASHEET OF
MC74HCT244ADTR2G**



MC74HCT244A

Octal 3-State Noninverting Buffer/Line Driver/ Line Receiver with LSTTL-Compatible Inputs

High-Performance Silicon-Gate CMOS

The MC74HCT244A is identical in pinout to the LS244. This device may be used as a level converter for interfacing TTL or NMOS outputs to High-Speed CMOS inputs. The HCT244A is an octal noninverting buffer line driver line receiver designed to be used with 3-state memory address drivers, clock drivers, and other bus-oriented systems. The device has non-inverted outputs and two active-low output enables.

The HCT244A is the non-inverting version of the HCT240. See also HCT241.

Features

- Output Drive Capability: 15 LSTTL Loads
- TTL NMOS-Compatible Input Levels
- Outputs Directly Interface to CMOS, NMOS, and TTL
- Operating Voltage Range: 4.5 to 5.5 V
- Low Input Current: 1 μ A
- In Compliance with the Requirements Defined by JEDEC Standard No. 7 A
- Chip Complexity: 112 FETs or 28 Equivalent Gates
- NLV Prefix for Automotive and Other Applications Requiring Unique Site and Control Change Requirements; AEC-Q100 Qualified and PPAP Capable
- These Devices are Pb-Free and are RoHS Compliant

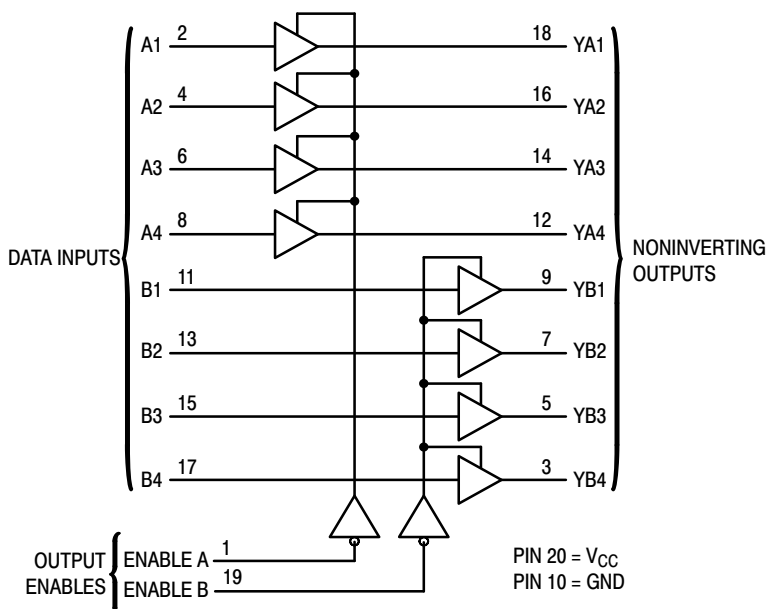

Figure 1. Logic Diagram



ON Semiconductor®

<http://onsemi.com>



SOIC-20W
DW SUFFIX
CASE 751D

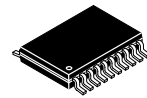

TSSOP-20
DT SUFFIX
CASE 948E

PIN ASSIGNMENT

ENABLE A	1	20	V _{CC}
A1	2	19	ENABLE B
YB4	3	18	YA1
A2	4	17	B4
YB3	5	16	YA2
A3	6	15	B3
YB2	7	14	YA3
A4	8	13	B2
YB1	9	12	YA4
GND	10	11	B1

MARKING DIAGRAMS

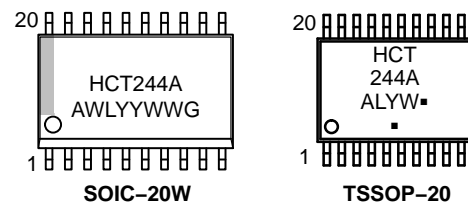

A = Assembly Location
WL, L = Wafer Lot
YY, Y = Year
WW, W = Work Week
G or ■ = Pb-Free Package

(Note: Microdot may be in either location)

FUNCTION TABLE

Inputs		Outputs
Enable A, Enable B	A, B	YA, YB
L	L	L
L	H	H
H	X	Z

Z = high impedance, X = don't care

ORDERING INFORMATION

See detailed ordering and shipping information on page 5 of this data sheet.

MC74HCT244A

MAXIMUM RATINGS

Symbol	Parameter	Value	Unit
V _{CC}	DC Supply Voltage (Referenced to GND)	-0.5 to +7	V
V _{in}	DC Input Voltage (Referenced to GND)	-0.5 to V _{CC} + 0.5	V
V _{out}	DC Output Voltage (Referenced to GND)	-0.5 to V _{CC} + 0.5	V
I _{in}	DC Input Current, per Pin	±20	mA
I _{out}	DC Output Current, per Pin	±35	mA
I _{CC}	DC Supply Current, V _{CC} and GND Pins	±75	mA
P _D	Power Dissipation in Still Air, SOIC Package† TSSOP Package†	500 450	mW
T _{stg}	Storage Temperature	-65 to +150	°C
T _L	Lead Temperature, 1 mm from Case for 10 Seconds (SOIC or TSSOP Package)	260	°C

This device contains protection circuitry to guard against damage due to high static voltages or electric fields. However, precautions must be taken to avoid applications of any voltage higher than maximum rated voltages to this high-impedance circuit. For proper operation, V_{in} and V_{out} should be constrained to the range GND ≤ (V_{in} or V_{out}) ≤ V_{CC}. Unused inputs must always be tied to an appropriate logic voltage level (e.g., either GND or V_{CC}). Unused outputs must be left open.

Stresses exceeding those listed in the Maximum Ratings table may damage the device. If any of these limits are exceeded, device functionality should not be assumed, damage may occur and reliability may be affected.

†Derating: SOIC Package: -7 mW/°C from 65° to 125°C
TSSOP Package: -6.1 mW/°C from 65° to 125°C

RECOMMENDED OPERATING CONDITIONS

Symbol	Parameter	Min	Max	Unit
V _{CC}	DC Supply Voltage (Referenced to GND)	4.5	5.5	V
V _{in} , V _{out}	DC Input Voltage, Output Voltage (Referenced to GND)	0	V _{CC}	V
T _A	Operating Temperature, All Package Types	-55	+125	°C
t _r , t _f	Input Rise and Fall Time (Figure 2)	0	500	ns

Functional operation above the stresses listed in the Recommended Operating Ranges is not implied. Extended exposure to stresses beyond the Recommended Operating Ranges limits may affect device reliability.

DC ELECTRICAL CHARACTERISTICS (Voltages Referenced to GND)

Symbol	Parameter	Test Conditions	V _{CC} V	Guaranteed Limit			Unit
				-55 to 25°C	≤ 85°C	≤ 125°C	
V _{IH}	Minimum High-Level Input Voltage	V _{out} = 0.1 V or V _{CC} - 0.1 V I _{out} ≤ 20 μA	4.5	2	2	2	V
			5.5	2	2	2	
V _{IL}	Maximum Low-Level Input Voltage	V _{out} = 0.1 V or V _{CC} - 0.1 V I _{out} ≤ 20 μA	4.5	0.8	0.8	0.8	V
			5.5	0.8	0.8	0.8	
V _{OH}	Minimum High-Level Output Voltage	V _{in} = V _{IH} or V _{IL} I _{out} ≤ 20 μA	4.5	4.4	4.4	4.4	V
		V _{in} = V _{IH} or V _{IL} I _{out} ≤ 6 mA	4.5	3.98	3.84	3.7	
V _{OL}	Maximum Low-Level Output Voltage	V _{in} = V _{IH} or V _{IL} I _{out} ≤ 20 μA	4.5	0.1	0.1	0.1	V
		V _{in} = V _{IH} or V _{IL} I _{out} ≤ 6 mA	4.5	0.26	0.33	0.4	
I _{in}	Maximum Input Leakage Current	V _{in} = V _{CC} or GND	5.5	±0.1	±1.0	±1.0	μA
I _{oz}	Maximum Three-State Leakage Current	Output in High-Impedance State V _{in} = V _{IL} or V _{IH} ; V _{out} = V _{CC} or GND	5.5	±0.5	±5.0	±10	μA
I _{CC}	Maximum Quiescent Supply Current (per Package)	V _{in} = V _{CC} or GND I _{out} = 0 μA	5.5	4	40	160	μA
ΔI _{CC}	Additional Quiescent Supply Current	V _{in} = 2.4 V, Any One Input V _{in} = V _{CC} or GND, Other Inputs I _{out} = 0 μA	5.5	≥ -55°C	25°C to 125°C		mA
				2.9	2.4		

1. Total Supply Current = I_{CC} + ΣΔI_{CC}.

MC74HCT244A

AC ELECTRICAL CHARACTERISTICS ($V_{CC} = 5.0 \text{ V} \pm 10\%$, $C_L = 50 \text{ pF}$, Input $t_r = t_f = 6 \text{ ns}$)

Symbol	Parameter	Guaranteed Limit			Unit
		-55 to 25 °C	≤ 85 °C	≤ 125 °C	
t_{PLH} , t_{PHL}	Maximum Propagation Delay, A to YA or B to YB (Figures 2 and 4)	20	25	30	ns
t_{PLZ} , t_{PHZ}	Maximum Propagation Delay, Output Enable to YA or YB (Figures 3 and 5)	26	33	39	ns
t_{PZL} , t_{PZH}	Maximum Propagation Delay, Output Enable to YA or YB (Figures 3 and 5)	22	28	33	ns
t_{TLH} , t_{THL}	Maximum Output Transition Time, Any Output (Figures 2 and 4)	12	15	18	ns
C_{in}	Maximum Input Capacitance	10	10	10	pF
C_{out}	Maximum Three-State Output Capacitance (Output in High-Impedance State)	15	15	15	pF
C_{PD}	Power Dissipation Capacitance (Per Enabled Output)*	Typical @ 25°C, $V_{CC} = 5.0 \text{ V}$			pF
		55			

* Used to determine the no-load dynamic power consumption: $P_D = C_{PD} V_{CC}^2 f + I_{CC} V_{CC}$.

SWITCHING WAVEFORMS

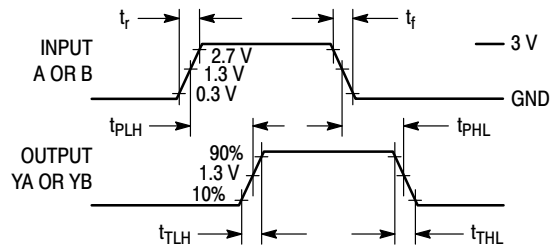

Figure 2.

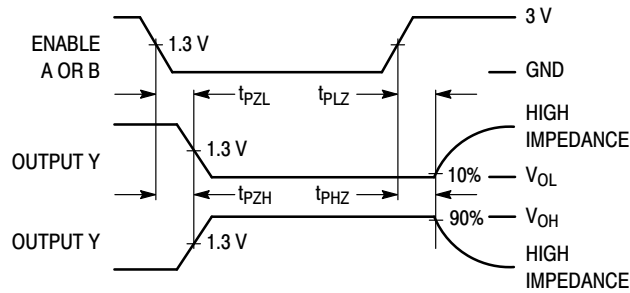

Figure 3.

MC74HCT244A

ORDERING INFORMATION

Device	Package	Shipping†
MC74HCT244ADWG	SOIC-20 (Pb-Free)	38 Units / Rail
MC74HCT244ADWR2G	SOIC-20 (Pb-Free)	1000 / Tape & Reel
MC74HCT244ADTR2G	TSSOP-20 (Pb-Free)	2500 / Tape & Reel
NLVHCT244ADTR2G*	TSSOP-20 (Pb-Free)	2500 / Tape & Reel

†For information on tape and reel specifications, including part orientation and tape sizes, please refer to our Tape and Reel Packaging Specifications Brochure, BRD8011/D.

*NLV Prefix for Automotive and Other Applications Requiring Unique Site and Control Change Requirements; AEC-Q100 Qualified and PPAP Capable.

MC74HCT244A

PACKAGE DIMENSIONS

TSSOP-20
DT SUFFIX
CASE 948E-02
ISSUE C

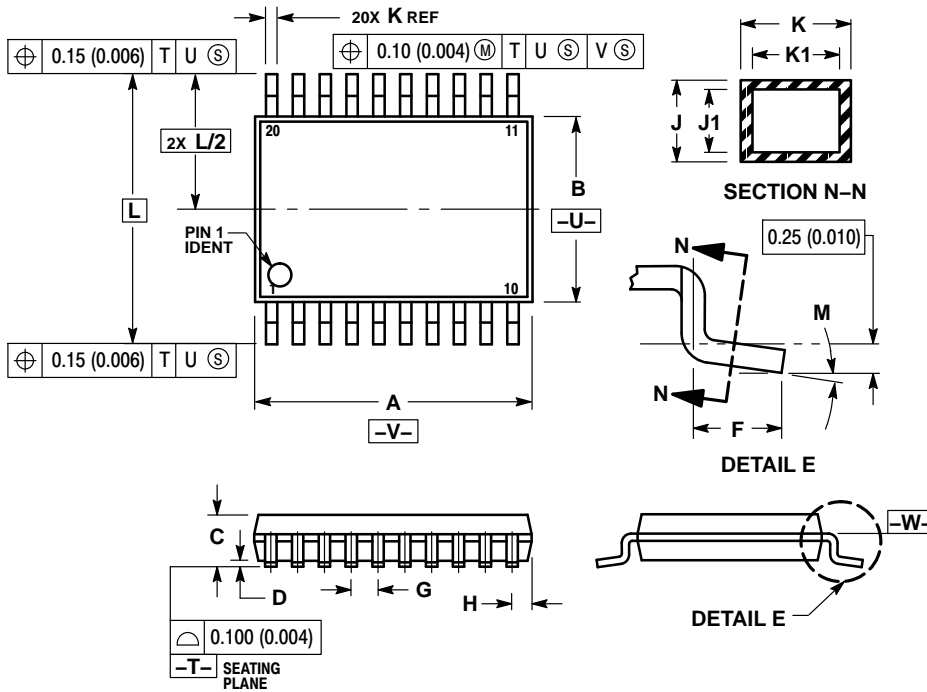

- NOTES:
1. DIMENSIONING AND TOLERANCING PER ANSI Y14.5M, 1982.
 2. CONTROLLING DIMENSION: MILLIMETER.
 3. DIMENSION A DOES NOT INCLUDE MOLD FLASH, PROTRUSIONS OR GATE BURRS. MOLD FLASH OR GATE BURRS SHALL NOT EXCEED 0.15 (0.006) PER SIDE.
 4. DIMENSION B DOES NOT INCLUDE INTERLEAD FLASH OR PROTRUSION. INTERLEAD FLASH OR PROTRUSION SHALL NOT EXCEED 0.25 (0.010) PER SIDE.
 5. DIMENSION K DOES NOT INCLUDE DAMBAR PROTRUSION. ALLOWABLE DAMBAR PROTRUSION SHALL BE 0.08 (0.003) TOTAL IN EXCESS OF THE K DIMENSION AT MAXIMUM MATERIAL CONDITION.
 6. TERMINAL NUMBERS ARE SHOWN FOR REFERENCE ONLY.
 7. DIMENSION A AND B ARE TO BE DETERMINED AT DATUM PLANE -W-.

SOLDERING FOOTPRINT*

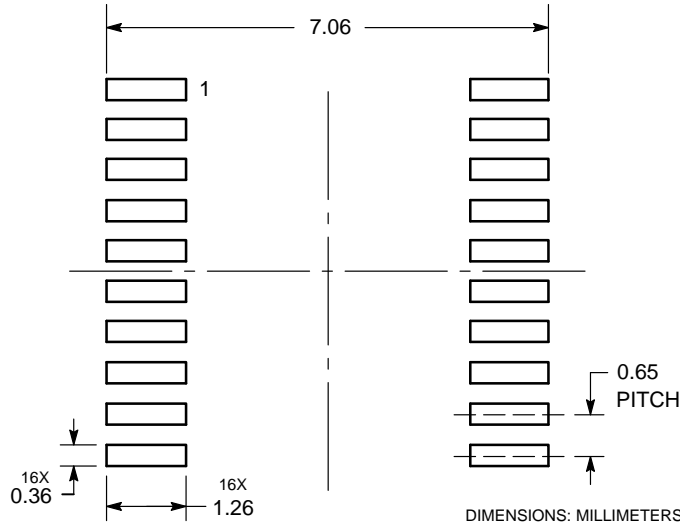

*For additional information on our Pb-Free strategy and soldering details, please download the ON Semiconductor Soldering and Mounting Techniques Reference Manual, SOLDERRM/D.

MC74HCT244A

PACKAGE DIMENSIONS

SOIC-20W
DW SUFFIX
CASE 751D-05
ISSUE G

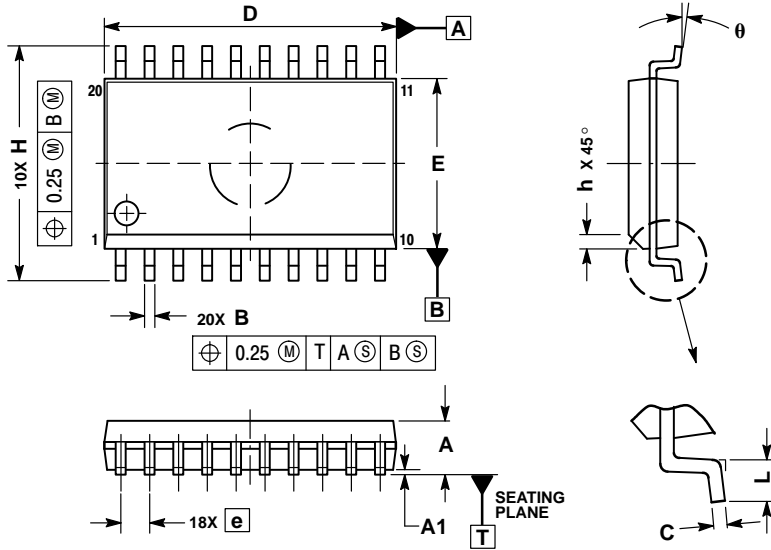

NOTES:

1. DIMENSIONS ARE IN MILLIMETERS.
2. INTERPRET DIMENSIONS AND TOLERANCES PER ASME Y14.5M, 1994.
3. DIMENSIONS D AND E DO NOT INCLUDE MOLD PROTRUSION.
4. MAXIMUM MOLD PROTRUSION 0.15 PER SIDE.
5. DIMENSION B DOES NOT INCLUDE DAMBAR PROTRUSION. ALLOWABLE PROTRUSION SHALL BE 0.13 TOTAL IN EXCESS OF B DIMENSION AT MAXIMUM MATERIAL CONDITION.

DIM	MILLIMETERS	
	MIN	MAX
A	2.35	2.65
A1	0.10	0.25
B	0.35	0.49
C	0.23	0.32
D	12.65	12.95
E	7.40	7.60
e	1.27 BSC	
H	10.05	10.55
h	0.25	0.75
L	0.50	0.90
theta	0°	7°

ON Semiconductor and the are registered trademarks of Semiconductor Components Industries, LLC (SCILLC) or its subsidiaries in the United States and/or other countries. SCILLC owns the rights to a number of patents, trademarks, copyrights, trade secrets, and other intellectual property. A listing of SCILLC's product/patent coverage may be accessed at www.onsemi.com/site/pdf/Patent-Marking.pdf. SCILLC reserves the right to make changes without further notice to any products herein. SCILLC makes no warranty, representation or guarantee regarding the suitability of its products for any particular purpose, nor does SCILLC assume any liability arising out of the application or use of any product or circuit, and specifically disclaims any and all liability, including without limitation special, consequential or incidental damages. "Typical" parameters which may be provided in SCILLC data sheets and/or specifications can and do vary in different applications and actual performance may vary over time. All operating parameters, including "Typicals" must be validated for each customer application by customer's technical experts. SCILLC does not convey any license under its patent rights nor the rights of others. SCILLC products are not designed, intended, or authorized for use as components in systems intended for surgical implant into the body, or other applications intended to support or sustain life, or for any other application in which the failure of the SCILLC product could create a situation where personal injury or death may occur. Should Buyer purchase or use SCILLC products for any such unintended or unauthorized application, Buyer shall indemnify and hold SCILLC and its officers, employees, subsidiaries, affiliates, and distributors harmless against all claims, costs, damages, and expenses, and reasonable attorney fees arising out of, directly or indirectly, any claim of personal injury or death associated with such unintended or unauthorized use, even if such claim alleges that SCILLC was negligent regarding the design or manufacture of the part. SCILLC is an Equal Opportunity/Affirmative Action Employer. This literature is subject to all applicable copyright laws and is not for resale in any manner.

PUBLICATION ORDERING INFORMATION

LITERATURE FULFILLMENT:

Literature Distribution Center for ON Semiconductor
P.O. Box 5163, Denver, Colorado 80217 USA
Phone: 303-675-2175 or 800-344-3860 Toll Free USA/Canada
Fax: 303-675-2176 or 800-344-3867 Toll Free USA/Canada
Email: orderlit@onsemi.com

N. American Technical Support: 800-282-9855 Toll Free
USA/Canada
Europe, Middle East and Africa Technical Support:
Phone: 421 33 790 2910
Japan Customer Focus Center
Phone: 81-3-5817-1050

ON Semiconductor Website: www.onsemi.com
Order Literature: <http://www.onsemi.com/orderlit>

For additional information, please contact your local Sales Representative

Looking for pricing, stock, or lifecycle information?

Click below to explore more details on WIN SOURCE:

 [View MC74HCT244ADTR2G on WIN SOURCE](#)

 [ON Semiconductor](#) Information

Optimize Your Supply Chain with WIN SOURCE Solutions

-  Global Sourcing Solution
-  Obsolete Management
-  Cost Control Management
-  Shortage Management
-  Alternative Solution
-  Excess Inventory Management