



**THE DATASHEET OF
DS14C335MSAX**



DS14C335 +3.3V Supply TIA/EIA-232 3 x 5 Driver/Receiver

Check for Samples: [DS14C335](#)

FEATURES

- **Conforms to TIA/EIA-232-E and CCITT V.28 Specifications**
- **Operates with Single +3.3V Power Supply**
- **Low Power Requirement— I_{CC} 20 mA Maximum**
- **SHUTDOWN Mode— I_{CX} 10 μ A Maximum**
- **One Receiver (R5) Active During SHUTDOWN**
- **Operates up to 128 kbps— Lap-Link Compatible**
- **Flow Through Pinout**
- **4V/ μ s Minimum Slew Rate Ensured**
- **Inter-operates with +5V UARTs**
- **Available in 28-lead SSOP EIAJ Type II Package**

DESCRIPTION

The DS14C335 is three driver, five receiver device which conforms to TIA/EIA-232-E and CCITT V.28 standard specifications. This device employs an internal DC-DC converter to generate the necessary output levels from a +3.3V power supply. A SHUTDOWN (SD) mode reduces the supply current to 10 μ A maximum. In the SD mode, one receiver is active, allowing ring indicator (RI) to be monitored. PC Board space consumption is minimized by the availability of Shrink Small Outline Packaging (SSOP).

This device's low power requirement and small footprint makes it an ideal choice for Laptop and Notebook applications.

Connection Diagram

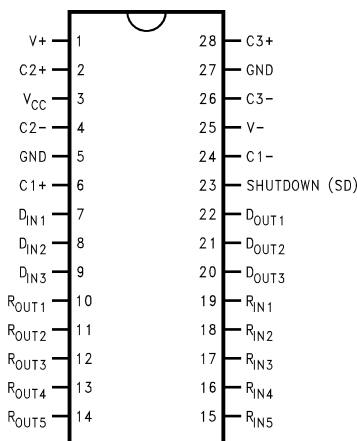

**Figure 1. DS14C335
Top View
See Package Number DB0028A**



Please be aware that an important notice concerning availability, standard warranty, and use in critical applications of Texas Instruments semiconductor products and disclaimers thereto appears at the end of this data sheet.

All trademarks are the property of their respective owners.

Functional Diagram

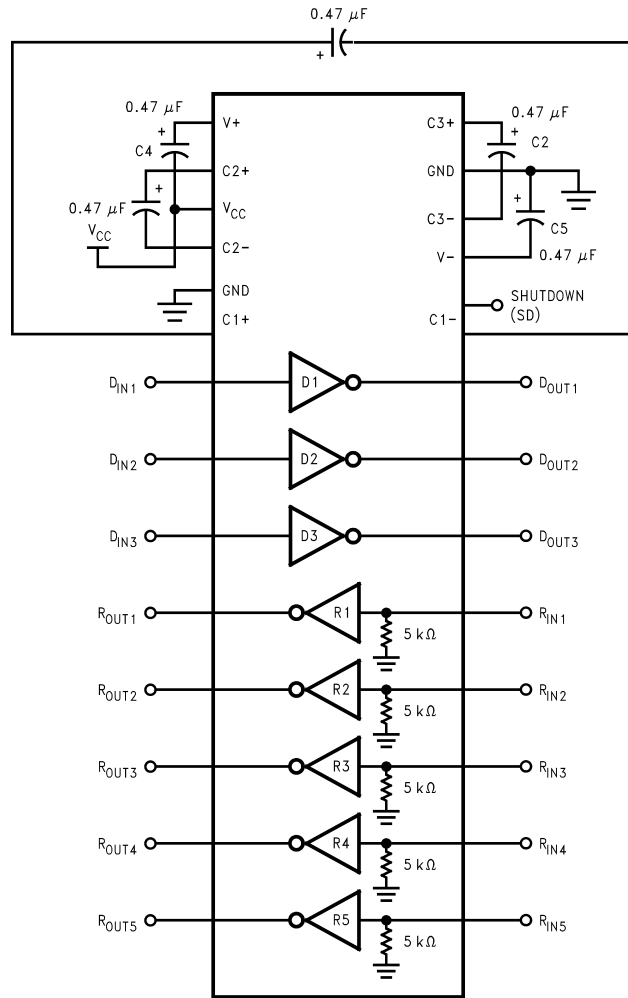

These devices have limited built-in ESD protection. The leads should be shorted together or the device placed in conductive foam during storage or handling to prevent electrostatic damage to the MOS gates.

Absolute Maximum Ratings⁽¹⁾⁽²⁾

Supply Voltage (V_{CC})		-0.3V to +6V
V^+ Pin		($V_{CC}-0.3V$) to +14V
V^- Pin		+0.3V to -14V
Input Voltage (DIN, SD)		-0.3V to +5.5V
Driver Output Voltage		($V^+ + 0.3V$) to ($V^- - 0.3V$)
Receiver Input Voltage		$\pm 25V$
Receiver Output Voltage		-0.3V to ($V_{CC} + 0.3V$)
Junction Temperature		+150°C
Storage Temperature Range		-65°C to +150°C
Lead Temperature (Soldering 4 sec.)		+260°C
Short Circuit Duration (D_{OUT})		continuous
Maximum Package Power Dissipation @ +25°C	SSOP DB Package	1286 mW
	Derate DB Package 10.3 mW/°C above +25°C	
ESD Rating (HBM, 1.5 k Ω , 100 pF)		≥ 2.0 kV

- (1) "Absolute Maximum Ratings" are those values beyond which the safety of the device cannot be specified. They are not meant to imply that the devices should be operated at these limits. The tables of "Electrical Characteristics" specify conditions for device operation.
- (2) If Military/Aerospace specified devices are required, please contact the Texas Instruments Sales Office/ Distributors for availability and specifications.

Recommended Operating Conditions

	Min	Max	Units
Supply Voltage (V_{CC})	3.0	3.6	V
DC-DC Converter Capacitors (C1–C5)	0.47		μF
Operating Free Air Temperature (T_A)	0	+70	°C

Electrical Characteristics⁽¹⁾⁽²⁾

Over recommended operating conditions, SD = 0.8V, unless otherwise specified.

Symbol	Parameter	Conditions	Min	Typ	Max	Units
DEVICE CHARACTERISTICS						
V^+	Positive Power Supply	No Load		+9.3		V
V^-	Negative Power Supply	C1–C5 = 0.47 μF		-9.0		V
I_{CC}	Supply Current	No Load		11.5	20	mA
I_{CX}	SHUTDOWN Supply Current	$R_L = 3$ k Ω , SD = V_{CC} , 5.5V		1.0	10	μA
V_{IH}	High Level Enable Voltage		SD	2.0		V
V_{IL}	Low Level Enable Voltage			GND	0.8	V
I_{IH}	High Level Enable Current	$2.0V \leq V_{IN} \leq 5.5V$			+2.0	μA
I_{IL}	Low Level Enable Current	$GND \leq V_{IN} \leq 0.8V$		-2.0		μA
DRIVER CHARACTERISTICS⁽³⁾						
V_{IH}	High Level Input Voltage		D_{IN}	2.0		V
V_{IL}	Low Level Input Voltage			GND	0.8	V
I_{IH}	High Level Input Current	$2.0V \leq V_{IN} \leq 5.5V$			+1.0	μA
I_{IL}	Low Level Input Current	$GND \leq V_{IN} \leq 0.8V$		-1.0		μA
V_{OH}	High Level Output Voltage	$R_L = 3$ k Ω		+5.0	+7.1	V
V_{OL}	Low Level Output Voltage			-6.3	-5.0	V
I_{OS+}	Output High Short Circuit Current	$V_O = 0V$, $V_{IN} = 0.8V^{(4)}$		-40	-16.5	mA
I_{OS-}	Output Low Short Circuit Current	$V_O = 0V$, $V_{IN} = 2.0V^{(4)}$		6	12.3	mA

(1) Typical values are given for $V_{CC} = 3.3V$ and $T_A = +25^\circ C$.

(2) Current into device pins is defined as positive. Current out of device pins is defined as negative. All voltages are referenced to ground unless otherwise specified.

(3) Generator characteristics for driver input: $f = 64$ kHz (128 kbits/sec), $t_r = t_f < 10$ ns, $V_{IH} = 3V$, $V_{IL} = 0V$, duty cycle = 50%.

(4) Only one driver output shorted at a time.

Electrical Characteristics⁽¹⁾⁽²⁾ (continued)

Over recommended operating conditions, SD = 0.8V, unless otherwise specified.

Symbol	Parameter	Conditions	Min	Typ	Max	Units
R _O	Output Resistance	-2V ≤ V _O ≤ +2V, V _{CC} = GND = 0V	300			Ω
RECEIVER CHARACTERISTICS⁽⁵⁾⁽⁶⁾						
V _{TH}	Input High Threshold Voltage	R1–R5, SD = 0.8V		1.4	2.4	V
		R5, 2.0V ≤ SD ≤ 5.5V		2.0	2.8	V
V _{TL}	Input Low Threshold Voltage	R1–R5, SD = 0.8V	0.4	1.1		V
		R5, 2.0V ≤ SD ≤ 5.5V	0.1	0.5		V
V _{HY}	Hysteresis		50	300		mV
R _{IN}	Input Resistance	V _{IN} = ±3V to ±15V	3.0	3.8	7.0	kΩ
I _{IN}	Input Current	V _{IN} = +15V	2.14		5.0	mA
		V _{IN} = +3V	0.43		1.0	mA
		V _{IN} = -3V	-1.0		-0.43	mA
		V _{IN} = -15V	-5.0		-2.14	mA
V _{OH}	High Level Output Voltage	V _{IN} = -3V, I _{OH} = -1 mA	2.4	3.1		V
		V _{IN} = -3V, I _{OH} = -100 μA	2.8	3.28		V
V _{OL}	Low Level Output Voltage	V _{IN} = +3V, I _{OL} = +2 mA		0.23	0.4	V

(5) Receiver characteristics are specified for SD = 0.8V. When SD = 2.0V, receiver five (R5) is active and meets receiver parameters in SHUTDOWN (SD) mode, unless otherwise specified.

(6) Generator characteristics for receiver input: f = 64 kHz (128 kbits/sec), t_r = t_f = 200 ns, V_{IH} = 3V, V_{IL} = -3V, duty cycle = 50%.

Switching Characteristics⁽¹⁾

Over recommended operating conditions, SD = 0.8V, unless otherwise specified.

Symbol	Parameter	Conditions	Min	Typ	Max	Units
DRIVER CHARACTERISTICS						
t _{PLH}	Propagation Delay LOW to HIGH	R _L = 3 kΩ C _L = 50 pF (Figure 2, Figure 3)	0.1	0.6	1.0	μs
t _{PHL}	Propagation Delay HIGH to LOW		0.1	0.6	1.0	μs
t _{SK}	Skew t _{PLH} - t _{PHL}			0	0.2	μs
SR1	Output Slew Rate	R _L = 3 kΩ to 7 kΩ, C _L = 50 pF (Figure 3)	4	13	30	V/μs
SR2	Output Slew Rate	R _L = 3 kΩ, C _L = 2500 pF (Figure 3)	4	10	30	V/μs
t _{PLS}	Propagation Delay LOW to SD	(Figure 6, Figure 7)		0.48		ms
t _{PSL}	Propagation Delay SD to LOW	R _L = 3 kΩ C _L = 50 pF		1.88		ms
t _{PHS}	Propagation Delay HIGH to SD			0.62		ms
t _{PSH}	Propagation Delay SD to HIGH			1.03		ms
RECEIVER CHARACTERISTICS						
t _{PLH}	Propagation Delay LOW to HIGH	C _L = 50 pF (Figure 4, Figure 4)	0.1	0.4	1.0	μs
t _{PHL}	Propagation Delay HIGH to LOW		0.1	0.6	1.0	μs
t _{SK}	Skew t _{PLH} - t _{PHL}			0.2	0.8	μs
t _{PLS}	Propagation Delay LOW to SD	(Figure 8, Figure 9)		0.13		μs
t _{PSL}	Propagation Delay SD to LOW	R _L = 1 kΩ C _L = 50 pF R1–R4 Only		1.0		μs
t _{PHS}	Propagation Delay HIGH to SD			0.19		μs
t _{PSH}	Propagation Delay SD to HIGH			0.58		μs

(1) Typical values are given for V_{CC} = 3.3V and T_A = +25°C.

Parameter Measurement Information

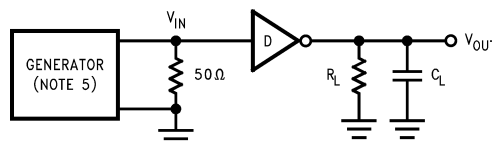

Figure 2. Driver Propagation Delay and Slew Rate Test Circuit

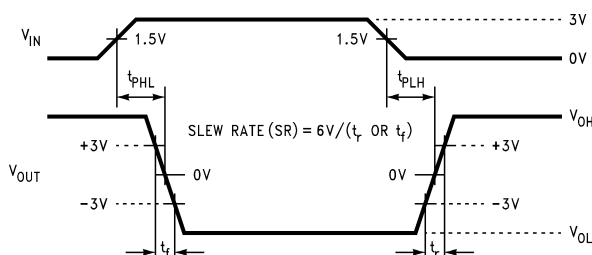

Figure 3. Driver Propagation Delay and Slew Rate Timing

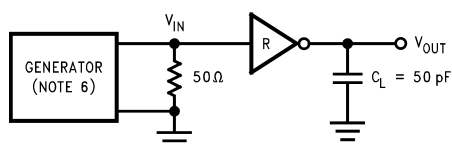

Figure 4. Receiver Propagation Delay Test Circuit

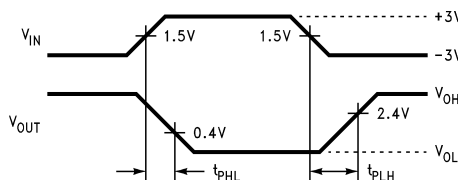

Figure 5. Receiver Propagation Delay Timing

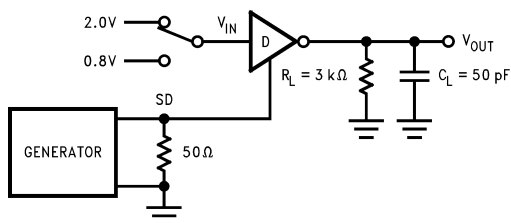

Figure 6. Driver SHUTDOWN (SD) Delay Test Circuit

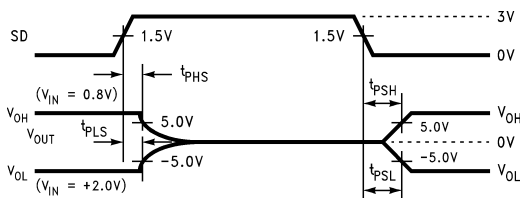

Figure 7. Driver SHUTDOWN (SD) Delay Timing

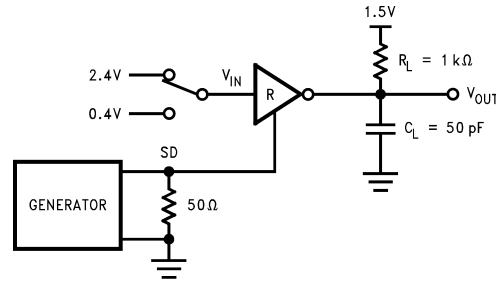

Figure 8. Receiver SHUTDOWN (SD) Delay Test Circuit

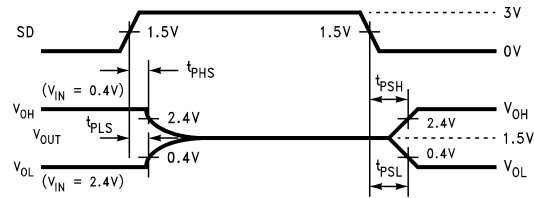

Figure 9. Receiver SHUTDOWN (SD) Delay Timing

PIN DESCRIPTIONS

V_{CC} (Pin 3). Power supply pin for the device, +3.3V (±0.3V).

V₊ (Pin 1). Positive supply for TIA/EIA-232-E drivers. Recommended external capacitor—0.47 μF (16V). This supply is not intended to be loaded externally.

V₋ (Pin 25). Negative supply for TIA/EIA-232-E drivers. Recommended external capacitor—0.47 μF (16V). This supply is not intended to be loaded externally.

C1+, C1- (Pins 6, 24). External capacitor connection pins. Recommended capacitor—0.47 μF (6.3V).

C2+, C2- (Pins 2, 4). External capacitor connection pins. Recommended capacitor—0.47 μF (16V).

C3+, C3- (Pins 28, 26). External capacitor connection pins. Recommended capacitor—0.47 μF (6.3V).

SHUTDOWN (SD) (Pin 23). A High on the SHUTDOWN pin will lower the total I_{CC} current to less than 10 μA, providing a low power state. In this mode receiver R5 remains active. The SD pin should be driven or tied low (GND) to disable the shutdown mode.

D_{IN} 1–3 (Pins 7, 8, 9). Driver input pins are JEDEC 3.3V standard compatible.

D_{OUT} 1–3 (Pins 22, 21, 20). Driver output pins conform to TIA/EIA-232 -E levels.

R_{IN} 1–5 (Pins 19, 18, 17, 16, 15). Receiver input pins accept TIA/EIA-232-E input voltages (±25V). Receivers specifies hysteresis of TBD mV. Unused receiver input pins may be left open. Internal input resistor (5 kΩ) pulls input LOW, providing a failsafe HIGH output.

R_{OUT} 1–5 (Pins 10, 11, 12, 13, 14). Receiver output pins are JEDEC 3.3V standard compatible.

GND (Pin 27). Ground Pin.

APPLICATION INFORMATION

9-PIN SERIAL PORT APPLICATION

In a typical Data Terminal Equipment (DTE) to Data Circuit-Terminating Equipment (DCE) 9-pin de-facto interface implementation, 2 data lines and 6 control lines are required. The data lines are TXD and RXD and the control lines are RTS, DTR, DSR, DCD, CTS and RI. The DS14C335 is a 3 x 5 Driver/Receiver and offers a single chip solution for the DTE interface as shown in Figure 10.

Ring Indicator (RI) is used to inform the DTE that an incoming call is coming from a remote DCE. When the DS14C335 is in SHUTDOWN (SD) mode, receiver five (R5) remains active and monitors RI circuit. This active receiver (R5) alerts the DTE to switch the DS14C335 from SHUTDOWN to active mode.

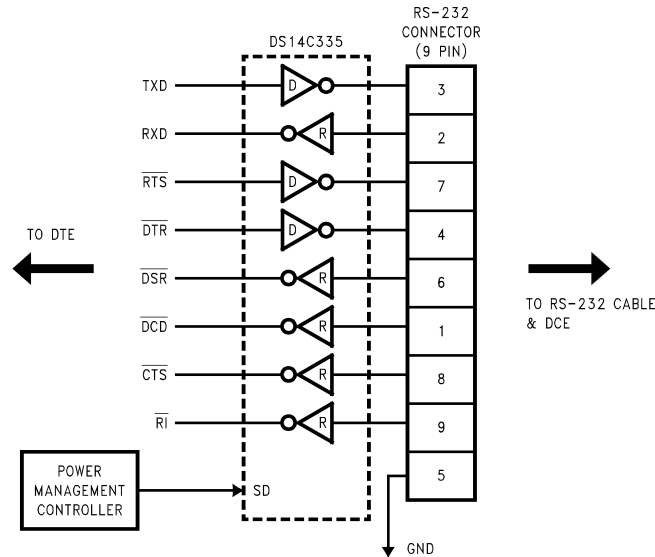

Figure 10. Typical DTE Application

MOUSE DRIVING

The DS14C335 was tested for drive current under the following mouse driving conditions:

- Two driver outputs set at V_{OH} and their outputs were tied together (paralleled), sourcing current to supply the $V+$ terminal of the mouse electronics
- One driver output set at V_{OL} to sink the current from the $V-$ terminal of the mouse electronics
- One receiver was used to accept data from the mouse
- Power Supply Voltage (V_{CC}): 3.0V to 3.6V

Completion of the testing (performed by TI's Data Transmission Applications Group and a major PC manufacturer) concluded that the DS14C335 and its DC-DC Converter supplied adequate drive capability to power a typical PC mouse. The mouse tested was specified with the following conditions:

10 mA at +6V

5.0 mA at -6V

Since driver current is limited, it is recommended that newer lower power mice be specified for battery powered applications. Using older high power mice is wasteful of precious battery charge.

EXTERNAL DC-DC CONVERTOR COMPONENTS

The DS14C335 with its unique DC-DC Converter triples the power supply voltage (3.0V) to +9.3V and then inverts it to a -9V potential. This unique converter **ONLY** requires 5 external surface mount 0.47 μ F capacitors. The five identical components were chosen to simplify PCB layout and the procurement of components. The DS14C335's DC-DC Converter also provides a larger signal swing (higher at RS-232 standard data rates) which translates to more noise margin for the rejection of ground potential differences, induced noise, and crosstalk compared to other DC-DC converter schemes which only provide limited signal swing and limited noise margin.

DC-DC CONVERTOR CAPACITORS

The use of polarized capacitors is not required. However, if they are used, the polarity indicated in the DS14C335 Functional Diagram must be honored for proper operation. Surface mount capacitors or ceramic capacitors may be used, however, for optimal efficiency, capacitors with a low effective series resistance (ESR) should be used. Values in the low Ohms(Ω) is normally acceptable.

INTEROPERATION WITH +5V UARTS

The DS14C335 provides full RS-232 driver output levels and a single chip solution for the popular 9-pin defacto serial port. This device may be used in either pure +3V applications or mixed power supplied +3V/+5V applications. The Driver Input (DIN) and ShutDown (SD) input pins can directly accept full +5V levels without the need for any external components. The Receiver Output (ROUT) is specified at 2.4V minimum while sourcing 1 mA. This level is compatible with standard TTL thresholds. For a complete discussion on "Interoperation of the DS14C335 with +5V UARTs" please see TI Application Note AN-876 ([SNLA163](#)).

POWER DISSIPATION IN REAL RS-232 APPLICATIONS

The DS14C335 DC-DC Converter uses special circuitry that helps limit the increase in power supply current as frequency increases. A complete description of power dissipation and calculations for RS-232 applications can be found in TI Application Note AN-914 ([SNLA037](#)) titled "Understanding Power Requirements in RS-232 Applications". Typical performance curves are also located in this datasheet for quick reference.

Typical Performance Characteristics

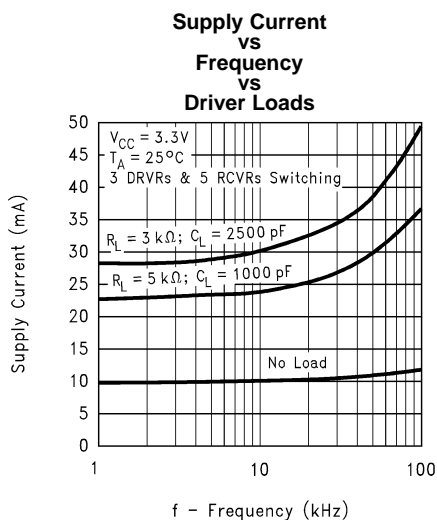

Figure 11.

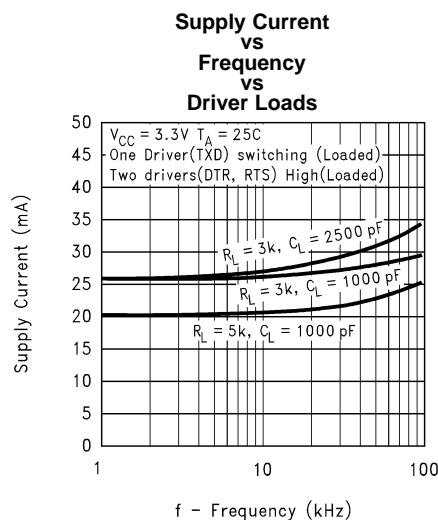

Figure 12.

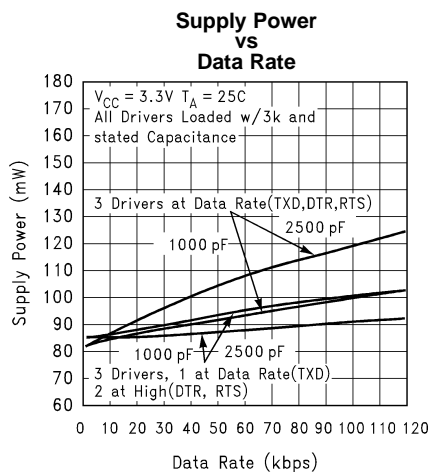

Figure 13.

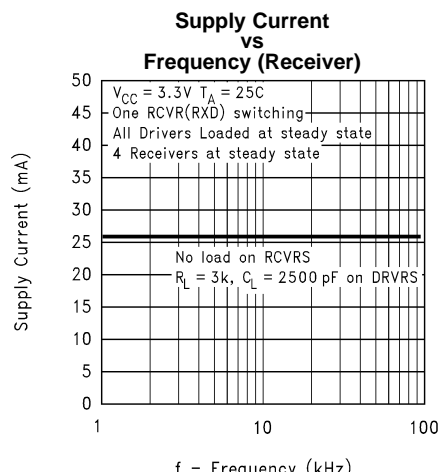

Figure 14.

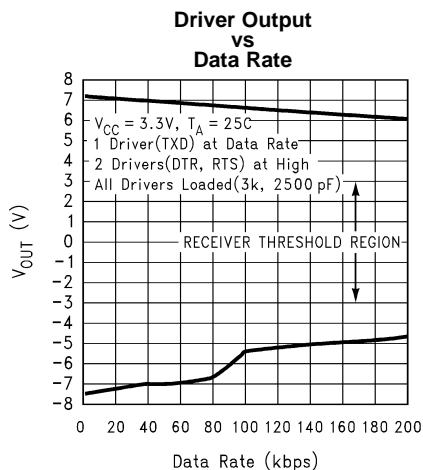

Figure 15.

REVISION HISTORY

Changes from Revision B (April 2013) to Revision C	Page
• Changed layout of National Data Sheet to TI format	9

PACKAGING INFORMATION

Orderable Device	Status (1)	Package Type	Package Drawing	Pins	Package Qty	Eco Plan (2)	Lead/Ball Finish (6)	MSL Peak Temp (3)	Op Temp (°C)	Device Marking (4/5)	Samples
DS14C335MSA	LIFEBUY	SSOP	DB	28	47	TBD	Call TI	Call TI	0 to 70	DS14C335 MSA	
DS14C335MSA/NOPB	LIFEBUY	SSOP	DB	28	47	Green (RoHS & no Sb/Br)	CU SN	Level-3-260C-168 HR	0 to 70	DS14C335 MSA	
DS14C335MSAX/NOPB	LIFEBUY	SSOP	DB	28	2000	Green (RoHS & no Sb/Br)	CU SN	Level-3-260C-168 HR	0 to 70	DS14C335 MSA	

(1) The marketing status values are defined as follows:

ACTIVE: Product device recommended for new designs.

LIFEBUY: TI has announced that the device will be discontinued, and a lifetime-buy period is in effect.

NRND: Not recommended for new designs. Device is in production to support existing customers, but TI does not recommend using this part in a new design.

PREVIEW: Device has been announced but is not in production. Samples may or may not be available.

OBsolete: TI has discontinued the production of the device.

(2) Eco Plan - The planned eco-friendly classification: Pb-Free (RoHS), Pb-Free (RoHS Exempt), or Green (RoHS & no Sb/Br) - please check <http://www.ti.com/productcontent> for the latest availability information and additional product content details.

TBD: The Pb-Free/Green conversion plan has not been defined.

Pb-Free (RoHS): TI's terms "Lead-Free" or "Pb-Free" mean semiconductor products that are compatible with the current RoHS requirements for all 6 substances, including the requirement that lead not exceed 0.1% by weight in homogeneous materials. Where designed to be soldered at high temperatures, TI Pb-Free products are suitable for use in specified lead-free processes.

Pb-Free (RoHS Exempt): This component has a RoHS exemption for either 1) lead-based flip-chip solder bumps used between the die and package, or 2) lead-based die adhesive used between the die and leadframe. The component is otherwise considered Pb-Free (RoHS compatible) as defined above.

Green (RoHS & no Sb/Br): TI defines "Green" to mean Pb-Free (RoHS compatible), and free of Bromine (Br) and Antimony (Sb) based flame retardants (Br or Sb do not exceed 0.1% by weight in homogeneous material)

(3) MSL, Peak Temp. - The Moisture Sensitivity Level rating according to the JEDEC industry standard classifications, and peak solder temperature.

(4) There may be additional marking, which relates to the logo, the lot trace code information, or the environmental category on the device.

(5) Multiple Device Markings will be inside parentheses. Only one Device Marking contained in parentheses and separated by a "~" will appear on a device. If a line is indented then it is a continuation of the previous line and the two combined represent the entire Device Marking for that device.

(6) Lead/Ball Finish - Orderable Devices may have multiple material finish options. Finish options are separated by a vertical ruled line. Lead/Ball Finish values may wrap to two lines if the finish value exceeds the maximum column width.

Important Information and Disclaimer: The information provided on this page represents TI's knowledge and belief as of the date that it is provided. TI bases its knowledge and belief on information provided by third parties, and makes no representation or warranty as to the accuracy of such information. Efforts are underway to better integrate information from third parties. TI has taken and

continues to take reasonable steps to provide representative and accurate information but may not have conducted destructive testing or chemical analysis on incoming materials and chemicals. TI and TI suppliers consider certain information to be proprietary, and thus CAS numbers and other limited information may not be available for release.

In no event shall TI's liability arising out of such information exceed the total purchase price of the TI part(s) at issue in this document sold by TI to Customer on an annual basis.

TAPE AND REEL INFORMATION



QUADRANT ASSIGNMENTS FOR PIN 1 ORIENTATION IN TAPE



*All dimensions are nominal

Device	Package Type	Package Drawing	Pins	SPQ	Reel Diameter (mm)	Reel Width W1 (mm)	A0 (mm)	B0 (mm)	K0 (mm)	P1 (mm)	W (mm)	Pin1 Quadrant
DS14C335MSAX/NOPB	SSOP	DB	28	2000	330.0	16.4	8.4	10.7	2.4	12.0	16.0	Q1

TAPE AND REEL BOX DIMENSIONS



*All dimensions are nominal

Device	Package Type	Package Drawing	Pins	SPQ	Length (mm)	Width (mm)	Height (mm)
DS14C335MSAX/NOPB	SSOP	DB	28	2000	367.0	367.0	38.0

DB (R-PDSO-G**)

PLASTIC SMALL-OUTLINE

28 PINS SHOWN



- NOTES: A. All linear dimensions are in millimeters.
 B. This drawing is subject to change without notice.
 C. Body dimensions do not include mold flash or protrusion not to exceed 0,15.
 D. Falls within JEDEC MO-150

IMPORTANT NOTICE

Texas Instruments Incorporated and its subsidiaries (TI) reserve the right to make corrections, enhancements, improvements and other changes to its semiconductor products and services per JESD46, latest issue, and to discontinue any product or service per JESD48, latest issue. Buyers should obtain the latest relevant information before placing orders and should verify that such information is current and complete. All semiconductor products (also referred to herein as "components") are sold subject to TI's terms and conditions of sale supplied at the time of order acknowledgment.

TI warrants performance of its components to the specifications applicable at the time of sale, in accordance with the warranty in TI's terms and conditions of sale of semiconductor products. Testing and other quality control techniques are used to the extent TI deems necessary to support this warranty. Except where mandated by applicable law, testing of all parameters of each component is not necessarily performed.

TI assumes no liability for applications assistance or the design of Buyers' products. Buyers are responsible for their products and applications using TI components. To minimize the risks associated with Buyers' products and applications, Buyers should provide adequate design and operating safeguards.

TI does not warrant or represent that any license, either express or implied, is granted under any patent right, copyright, mask work right, or other intellectual property right relating to any combination, machine, or process in which TI components or services are used. Information published by TI regarding third-party products or services does not constitute a license to use such products or services or a warranty or endorsement thereof. Use of such information may require a license from a third party under the patents or other intellectual property of the third party, or a license from TI under the patents or other intellectual property of TI.

Reproduction of significant portions of TI information in TI data books or data sheets is permissible only if reproduction is without alteration and is accompanied by all associated warranties, conditions, limitations, and notices. TI is not responsible or liable for such altered documentation. Information of third parties may be subject to additional restrictions.

Resale of TI components or services with statements different from or beyond the parameters stated by TI for that component or service voids all express and any implied warranties for the associated TI component or service and is an unfair and deceptive business practice. TI is not responsible or liable for any such statements.

Buyer acknowledges and agrees that it is solely responsible for compliance with all legal, regulatory and safety-related requirements concerning its products, and any use of TI components in its applications, notwithstanding any applications-related information or support that may be provided by TI. Buyer represents and agrees that it has all the necessary expertise to create and implement safeguards which anticipate dangerous consequences of failures, monitor failures and their consequences, lessen the likelihood of failures that might cause harm and take appropriate remedial actions. Buyer will fully indemnify TI and its representatives against any damages arising out of the use of any TI components in safety-critical applications.

In some cases, TI components may be promoted specifically to facilitate safety-related applications. With such components, TI's goal is to help enable customers to design and create their own end-product solutions that meet applicable functional safety standards and requirements. Nonetheless, such components are subject to these terms.

No TI components are authorized for use in FDA Class III (or similar life-critical medical equipment) unless authorized officers of the parties have executed a special agreement specifically governing such use.

Only those TI components which TI has specifically designated as military grade or "enhanced plastic" are designed and intended for use in military/aerospace applications or environments. Buyer acknowledges and agrees that any military or aerospace use of TI components which have **not** been so designated is solely at the Buyer's risk, and that Buyer is solely responsible for compliance with all legal and regulatory requirements in connection with such use.

TI has specifically designated certain components as meeting ISO/TS16949 requirements, mainly for automotive use. In any case of use of non-designated products, TI will not be responsible for any failure to meet ISO/TS16949.

Products

Audio	www.ti.com/audio
Amplifiers	amplifier.ti.com
Data Converters	dataconverter.ti.com
DLP® Products	www.dlp.com
DSP	dsp.ti.com
Clocks and Timers	www.ti.com/clocks
Interface	interface.ti.com
Logic	logic.ti.com
Power Mgmt	power.ti.com
Microcontrollers	microcontroller.ti.com
RFID	www.ti-rfid.com
OMAP Applications Processors	www.ti.com/omap
Wireless Connectivity	www.ti.com/wirelessconnectivity

Applications

Automotive and Transportation	www.ti.com/automotive
Communications and Telecom	www.ti.com/communications
Computers and Peripherals	www.ti.com/computers
Consumer Electronics	www.ti.com/consumer-apps
Energy and Lighting	www.ti.com/energy
Industrial	www.ti.com/industrial
Medical	www.ti.com/medical
Security	www.ti.com/security
Space, Avionics and Defense	www.ti.com/space-avionics-defense
Video and Imaging	www.ti.com/video

TI E2E Community

e2e.ti.com

Looking for pricing, stock, or lifecycle information?

Click below to explore more details on WIN SOURCE:

 [View DS14C335MSAX](#) on WIN SOURCE

 [Texas Instruments](#) Information

Optimize Your Supply Chain with WIN SOURCE Solutions

-  Global Sourcing Solution
-  Obsolete Management
-  Cost Control Management
-  Shortage Management
-  Alternative Solution
-  Excess Inventory Management