



**THE DATASHEET OF
MAX6803US44D3+T**



MAX6803/MAX6804/ MAX6805

4-Pin, Low-Power µP Reset Circuits with Manual Reset

General Description

The MAX6803/MAX6804/MAX6805 microprocessor (µP) supervisory circuits monitor the power supplies in 2.85V to 5.0V µP and digital systems. They increase circuit reliability and reduce cost by eliminating external components and adjustments. They also feature a debounced manual-reset input.

These devices perform a single function: they assert a reset signal whenever the V_{CC} supply voltage declines below a preset threshold or whenever manual reset is asserted. Reset remains asserted for a preset timeout period after V_{CC} has risen above the reset threshold or after manual reset is deasserted. The only difference among the three devices is their output. The MAX6804 (push/pull) and MAX6805 (open-drain) have an active-low $\overline{\text{RESET}}$ output, while the MAX6803 (push/pull) has an active-high RESET output. The MAX6803/MAX6804 are guaranteed to be in the correct state for V_{CC} down to 0.7V. The MAX6805 is guaranteed to be in the correct state for V_{CC} down to 1.0V.

The reset comparator in these ICs is designed to ignore fast transients on V_{CC} . Reset thresholds are factory-trimmable between 2.63V and 4.80V, in approximately 100mV increments. These devices are available with a 1ms min, 20ms min, or 100ms min reset timeout period. Ideal for space-critical applications, the MAX6803/MAX6804/MAX6805 come packaged in a 4-pin SOT143. For a lower threshold voltage version, see the MAX6335/MAX6336/MAX6337.

Applications

- Computers
- Controllers
- Intelligent Instruments
- Critical µP/µC Power Monitoring
- Portable/Battery-Powered Equipment

Typical Operating Circuit and Pin Configuration appear at end of data sheet.

Selector Guide appears at end of data sheet.

Features

- Ultra-Low 0.7V Operating Supply Voltage
- Low 4.0µA Supply Current
- Precision Monitoring of 2.85V to 5.0V Power-Supply Voltages
- Reset Thresholds Available from 2.63V to 4.80V, in Approximately 100mV Increments
- Debounced Manual-Reset Input
- Fully Specified over Temperature
- Three Power-On Reset Timeout Periods Available (1ms min, 20ms min, 100ms min)
- Low Cost
- Three Available Output Structures: Push/Pull $\overline{\text{RESET}}$, Push/Pull RESET, Open-Drain $\overline{\text{RESET}}$
- Guaranteed RESET/ $\overline{\text{RESET}}$ Valid to $V_{CC} = 0.7V$ (MAX6803/MAX6804)
- Power-Supply Transient Immunity
- No External Components Required
- 4-Pin SOT143 Package
- Pin Compatible with MAX811/MAX812 and MAX6314/MAX6315

Ordering Information

PART*	TEMP RANGE	PIN-PACKAGE
MAX6803US__D_-T	-40°C to +125°C	4 SOT143
MAX6804US__D_-T	-40°C to +125°C	4 SOT143
MAX6805US__D_-T	-40°C to +125°C	4 SOT143

*These devices are available in factory-set V_{CC} reset thresholds from 2.63V to 4.80V, in approximately 0.1V increments. Choose the desired reset threshold suffix from Table 1 and insert it in the blanks following "US" in the part number. Factory-programmed reset timeout periods are also available. Insert the number corresponding to the desired nominal reset timeout period (1 = 1ms min, 2 = 20ms min, 3 = 100ms min) in the blank following "D" in the part number. There are 15 standard versions with a required order increment of 2500 pieces. Sample stock is generally held on the standard versions only (see Selector Guide). Contact the factory for availability of non-standard versions (required order increment is 10,000 pieces). All devices available in tape-and-reel only.

Devices are available in both leaded and lead-free packaging. Specify lead-free by replacing "-T" with "+T" when ordering.



Absolute Maximum Ratings

Terminal Voltage (with respect to GND)

V_{CC}	-0.3V to +6V
Push/Pull RESET or RESET, MR	-0.3V to ($V_{CC} + 0.3V$)
Open-Drain RESET	-0.3V to +6V
Input Current (V_{CC}).....	20mA
Output Current (RESET, RESET)	20mA

Continuous Power Dissipation ($T_A = +70^\circ\text{C}$)

4-Pin SOT143 (derate 4mW/°C above +70°C)	320mW
Operating Temperature Range.....	-40°C to +125°C
Junction Temperature.....	+150°C
Storage Temperature Range	-65°C to +150°C
Lead Temperature (soldering, 10s)	+300°C

Stresses beyond those listed under "Absolute Maximum Ratings" may cause permanent damage to the device. These are stress ratings only, and functional operation of the device at these or any other conditions beyond those indicated in the operational sections of the specifications is not implied. Exposure to absolute maximum rating conditions for extended periods may affect device reliability.

Electrical Characteristics

(V_{CC} = full range, $T_A = -40^\circ\text{C}$ to +125°C, unless otherwise noted. Typical values are at $V_{CC} = +5.0V$ and $T_A = +25^\circ\text{C}$, reset not asserted.) (Note 1)

PARAMETER	SYMBOL	CONDITIONS		MIN	TYP	MAX	UNITS
Supply Voltage Range (Note 1)	V_{CC}	$T_A = 0^\circ\text{C}$ to +125°C	MAX6803/MAX6804	0.7		5.5	V
			MAX6805	1.0		5.5	
		$T_A = -40^\circ\text{C}$ to +125°C	MAX6803/MAX6804	0.78		5.5	
			MAX6805	1.2		5.5	
Supply Current	I_{CC}	No load	$V_{CC} = +3.0V$		4	10	µA
			$V_{CC} = +5.0V$		5	12	
Reset Threshold	V_{TH}	MAX680_US__D_-T, Table 1	$T_A = +25^\circ\text{C}$	V_{TH} - 1.8%	V_{TH}	V_{TH} + 1.8%	V
			$T_A = -40^\circ\text{C}$ to +125°C	V_{TH} - 3%	V_{TH}	V_{TH} + 3%	
V_{CC} Falling Reset Delay		V_{CC} falling at 10V/ms			30		µs
Reset Active Timeout Period	t_{RP}	MAX680_US__D1-T		1	1.5	2	ms
		MAX680_US__D2-T		20	30	40	
		MAX680_US__D3-T		100	150	200	
MR Minimum Pulse Width				1			µs
MR Glitch Immunity					50		ns
MR Reset Delay					0.1		µs
MR Input Voltage	V_{IL}				$0.3 \times V_{CC}$		V
	V_{IH}			$0.7 \times V_{CC}$			
MR Pullup Resistance				12	20	30	kΩ
RESET Output Low Voltage (MAX6804/MAX6805)	V_{OL}	Reset asserted	$I_{SINK} = 50\mu\text{A}, V_{CC} \geq 1.0V$			0.4	V
			$I_{SINK} = 1.2\text{mA}, V_{CC} \geq 2.5V$			0.3	
			$I_{SINK} = 3.2\text{mA}, V_{CC} \geq 4.25V$			0.4	
RESET Output High Voltage (MAX6804)	V_{OH}	Reset not asserted	$I_{SOURCE} = 500\mu\text{A}, V_{CC} \geq 3.0V$	$0.8 \times V_{CC}$			V
			$I_{SOURCE} = 800\mu\text{A}, V_{CC} \geq 5.0V$	$0.8 \times V_{CC}$			

Electrical Characteristics (continued)

(V_{CC} = full range, T_A = -40°C to $+125^{\circ}\text{C}$, unless otherwise noted. Typical values are at V_{CC} = $+5.0\text{V}$ and T_A = $+25^{\circ}\text{C}$, reset not asserted.) (Note 1)

PARAMETER	SYMBOL	CONDITIONS	MIN	TYP	MAX	UNITS
RESET Output Voltage (MAX6803)	V_{OH}	Reset asserted	$I_{SOURCE} = 1\mu\text{A}, V_{CC} \geq 1.0\text{V}$	$0.8 \times V_{CC}$		V
			$I_{SOURCE} = 200\mu\text{A}, V_{CC} \geq 1.8\text{V}$	$0.8 \times V_{CC}$		
			$I_{SOURCE} = 800\mu\text{A}, V_{CC} \geq 4.25\text{V}$	$0.8 \times V_{CC}$		
	V_{OL}	Reset not asserted	$I_{SINK} = 1.2\text{mA}, V_{CC} \geq 3.0\text{V}$	0.3		V
$I_{SINK} = 3.2\text{mA}, V_{CC} \geq 5.0\text{V}$			0.4			
RESET Output Leakage Current (MAX6805)		$V_{CC} > V_{TH}$, RESET not asserted	0.5		μA	

Note 1: All parts are production tested at T_A = $+25^{\circ}\text{C}$. Over temperature limits are guaranteed by design and not production tested.

Note 2: I_{SOURCE} for the MAX6803 is 100nA ; I_{SINK} for the MAX6804 is 100nA ; I_{SINK} for the MAX6805 is $50\mu\text{A}$.

Typical Operating Characteristics

(Reset not asserted, T_A = $+25^{\circ}\text{C}$, unless otherwise noted.)

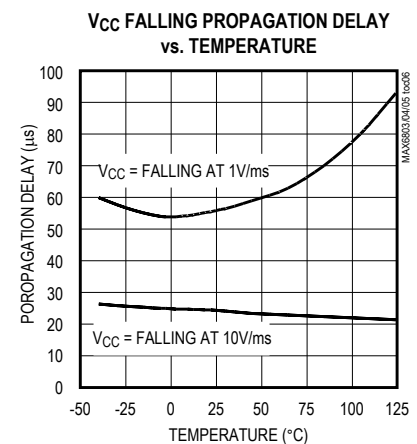
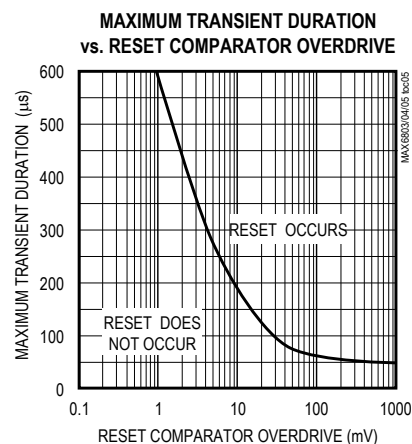
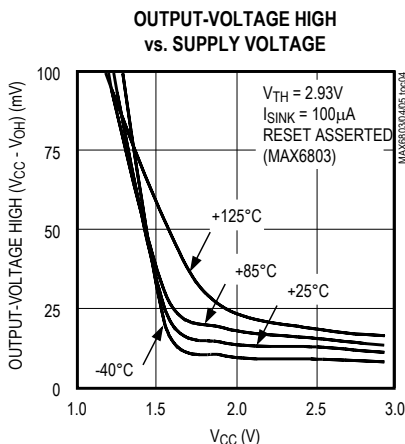
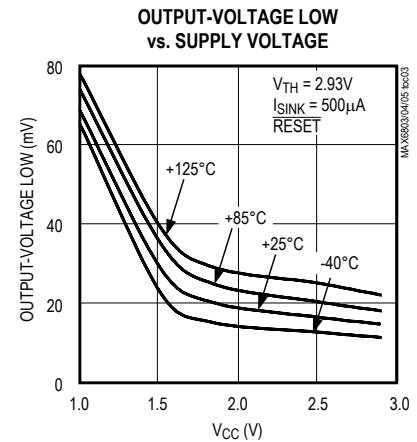
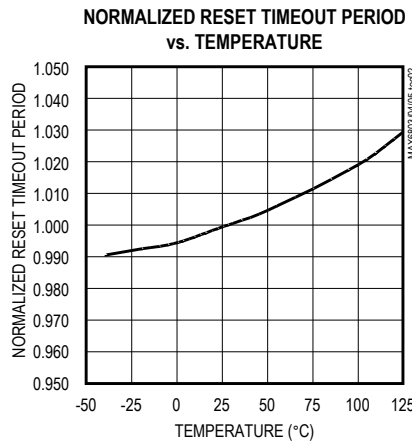
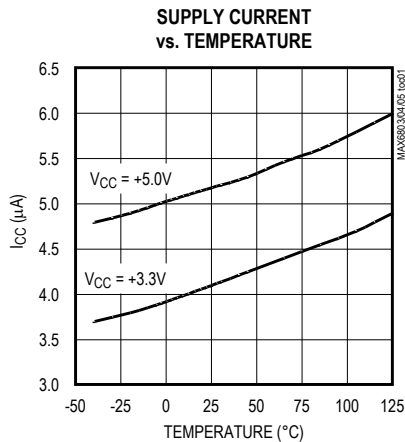

Pin Description

PIN		NAME	FUNCTION
MAX6803	MAX6804 MAX6805		
1	1	GND	Ground
—	2	$\overline{\text{RESET}}$	Active-Low Reset Output. $\overline{\text{RESET}}$ is asserted while VCC is below the reset threshold, or while $\overline{\text{MR}}$ is asserted. $\overline{\text{RESET}}$ remains asserted for a reset timeout period (tRP) after VCC rises above the reset threshold or $\overline{\text{MR}}$ is deasserted. RESET on the MAX6804 is push/pull. RESET on the MAX6805 is open-drain.
2	—	RESET	Active-High Reset Output. RESET is asserted high while VCC is below the reset threshold or while $\overline{\text{MR}}$ is asserted, and RESET remains asserted for a reset timeout period (tRP) after VCC rises above the reset threshold or $\overline{\text{MR}}$ is deasserted. RESET on the MAX6803 is push/pull.
3	3	$\overline{\text{MR}}$	Manual-Reset Input. A logic low on $\overline{\text{MR}}$ asserts reset. Reset remains asserted as long as $\overline{\text{MR}}$ is low, and for the reset timeout period (tRP) after $\overline{\text{MR}}$ goes high. Leave unconnected or connect to VCC if not used.
4	4	VCC	Supply Voltage Input

Applications Information

Manual-Reset Input

Many µP-based products require manual-reset capability, allowing the operator, a test technician, or external logic circuitry to initiate a reset. A logic low on $\overline{\text{MR}}$ asserts reset. Reset remains asserted while $\overline{\text{MR}}$ is low, and for the reset active timeout period after $\overline{\text{MR}}$ returns high. $\overline{\text{MR}}$ has an internal 20kΩ pullup resistor, so it can be left unconnected if not used. Connect a normally open momentary switch from $\overline{\text{MR}}$ to GND to create a manual-reset function; external debounce circuitry is not required.

Interfacing to µPs with Bidirectional Reset Pins

Since the $\overline{\text{RESET}}$ output on the MAX6805 is open-drain, this device interfaces easily with µPs that have bidirectional reset pins, such as the Motorola 68HC11. Connecting the µP supervisor's $\overline{\text{RESET}}$ output directly to the microcontroller's (µC's) RESET pin with a single pullup resistor allows either device to assert reset (Figure 1).

Negative-Going VCC Transients

In addition to issuing a reset to the µP during power-up, power-down, and brownout conditions, these devices are relatively immune to short-duration, negative-going VCC transients (glitches). The *Typical Operating Characteristics* show the Maximum Transient Duration vs. Reset Comparator Overdrive graph. The graph

shows the maximum pulse width that a negative-going VCC transient may typically have without issuing a reset signal. As the amplitude of the transient increases, the maximum allowable pulse width decreases.

Ensuring a Valid Reset Output Down to VCC = 0

When VCC falls below 1V and approaches the minimum operating voltage of 0.7V, push/pull-structured reset sinking (or sourcing) capabilities decrease drastically. High-impedance CMOS-logic inputs connected to the RESET pin can drift to indeterminate voltages. This does not present a problem in most cases, since most

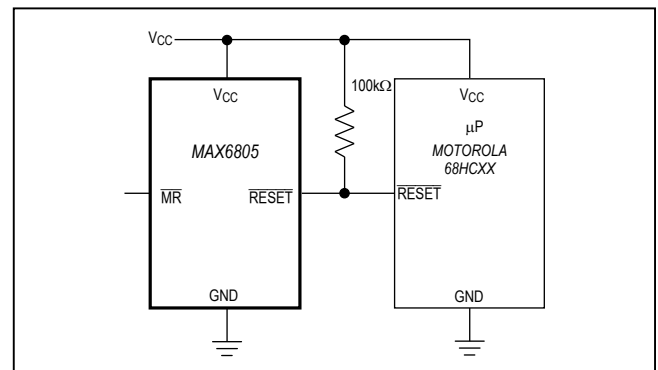

Figure 1. Interfacing to µPs with Bidirectional Reset Pins

MAX6803/MAX6804/ MAX6805

4-Pin, Low-Power μ P Reset Circuits with Manual Reset

μ Ps and circuitry do not operate when V_{CC} drops below 1V. For the MAX6804 application where \overline{RESET} must be valid down to 0, adding a pulldown resistor between \overline{RESET} and GND removes stray leakage currents, holding \overline{RESET} low (Figure 2a). The pulldown resistor value is not critical; $100k\Omega$ is large enough not to load \overline{RESET} , and small enough to pull it low. For the MAX6803, where RESET must be valid to $V_{CC} = 0$, a $100k\Omega$ pullup resistor between RESET and V_{CC} will hold RESET high when V_{CC} falls below 0.7V (Figure 2b).

Since the MAX6805 has an open-drain, active-low out-put, it typically uses a pullup resistor. With this device, \overline{RESET} will most likely not maintain an active condition, but will drift to a non-active level due to the pullup resistor and the reduced sinking capability of the open-drain device. Therefore, this device is not recommended for applications where the \overline{RESET} pin is required to be valid down to $V_{CC} = 0$.

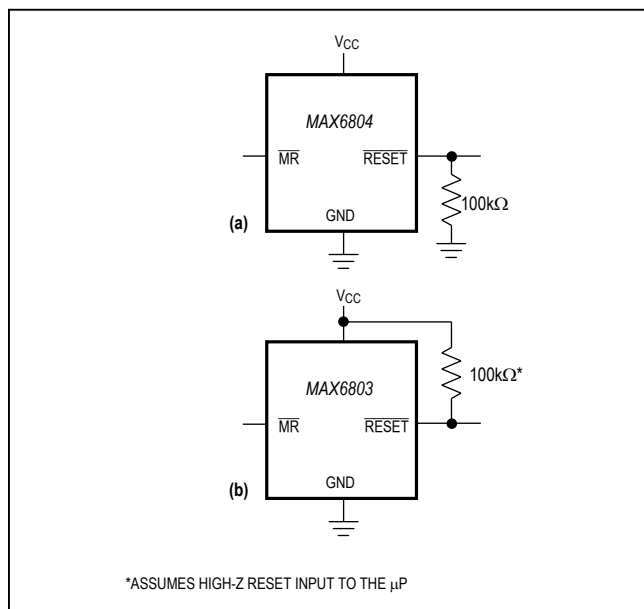
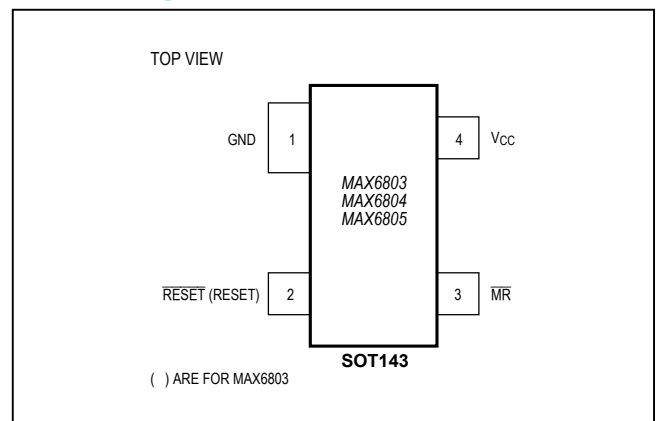

Figure 2. Ensuring Reset Valid down to $V_{CC} = 0$

Pin Configuration



Typical Operating Circuit

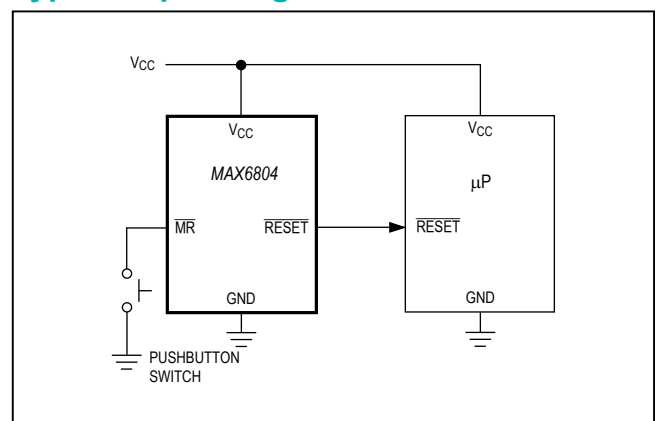

Table 1. Factory-Trimmed Reset Thresholds

RESET THRESHOLD SUFFIX	T _A = +25°C			T _A = -40°C to +125°C	
	MIN	TYP (V _{TH})	MAX	MIN	MAX
48	4.714	4.80	4.886	4.656	4.944
47	4.615	4.70	4.785	4.559	4.841
46	4.547	4.63	4.713	4.491	4.769
45	4.419	4.50	4.581	4.365	4.635
44	4.301	4.38	4.459	4.249	4.511
43	4.223	4.30	4.377	4.171	4.429
42	4.124	4.20	4.276	4.074	4.326
41	4.026	4.10	4.174	3.977	4.223
40	3.928	4.00	4.072	3.880	4.120
39	4.830	3.90	3.970	3.783	4.017
38	3.732	3.80	3.868	3.686	3.914
37	3.633	3.70	3.767	3.589	3.811
36	3.535	3.60	3.665	3.492	3.708
35	3.437	3.50	3.563	3.395	3.605
34	3.339	3.40	3.461	3.298	3.502
33	3.241	3.30	3.359	3.201	3.399
32	3.142	3.20	3.258	3.104	3.296
31	3.025	3.08	3.135	2.988	3.172
30	2.946	3.00	3.054	2.910	3.090
29	2.877	2.93	2.983	2.842	3.018
28	2.750	2.80	2.850	2.716	2.884
27	2.651	2.70	2.749	2.619	2.781
26	2.583	2.63	2.677	2.551	2.709

Selector Guide (Standard Versions*)

PART	OUTPUT STAGE	NOMINAL V _{TH} (V)	MIN RESET TIMEOUT (ms)	SOT TOP MARK
MAX6803US26D3-T	Push/Pull RESET	2.63	100	KACH
MAX6803US29D3-T	Push/Pull RESET	2.93	100	KACI
MAX6803US31D3-T	Push/Pull RESET	3.08	100	KACJ
MAX6803US44D3-T	Push/Pull RESET	4.38	100	KACK
MAX6803US46D3-T	Push/Pull RESET	4.63	100	KACL
MAX6804US26D3-T	Push/Pull $\overline{\text{RESET}}$	2.63	100	KACN
MAX6804US29D3-T	Push/Pull $\overline{\text{RESET}}$	2.93	100	KACP
MAX6804US31D3-T	Push/Pull $\overline{\text{RESET}}$	3.08	100	KACQ
MAX6804US44D3-T	Push/Pull $\overline{\text{RESET}}$	4.38	100	KACR
MAX6804US46D3-T	Push/Pull $\overline{\text{RESET}}$	4.63	100	KACS
MAX6805US26D3-T	Open-Drain $\overline{\text{RESET}}$	2.63	100	KACO
MAX6805US29D3-T	Open-Drain $\overline{\text{RESET}}$	2.93	100	KACU
MAX6805US31D3-T	Open-Drain $\overline{\text{RESET}}$	3.08	100	KACV
MAX6805US44D3-T	Open-Drain $\overline{\text{RESET}}$	4.38	100	KACW
MAX6805US46D3-T	Open-Drain $\overline{\text{RESET}}$	4.63	100	KACX

*Sample stock is generally held on all standard versions.

Chip Information

TRANSISTOR COUNT: 505
PROCESS: BiCMOS

Package Information

For the latest package outline information and land patterns (footprints), go to www.maximintegrated.com/packages. Note that a "+", "#", or "-" in the package code indicates RoHS status only. Package drawings may show a different suffix character, but the drawing pertains to the package regardless of RoHS status.

PACKAGE TYPE	PACKAGE CODE	OUTLINE NO.	LAND PATTERN NO.
4 SOT143	U4-1	21-0052	90-0183

Revision History

REVISION NUMBER	REVISION DATE	DESCRIPTION	PAGES CHANGED
3	7/14	No /V OPNs; removed Automotive reference from <i>Applications</i> section	1

For pricing, delivery, and ordering information, please contact Maxim Direct at 1-888-629-4642, or visit Maxim Integrated's website at www.maximintegrated.com.

Maxim Integrated cannot assume responsibility for use of any circuitry other than circuitry entirely embodied in a Maxim Integrated product. No circuit patent licenses are implied. Maxim Integrated reserves the right to change the circuitry and specifications without notice at any time. The parametric values (min and max limits) shown in the Electrical Characteristics table are guaranteed. Other parametric values quoted in this data sheet are provided for guidance.

Looking for pricing, stock, or lifecycle information?

Click below to explore more details on WIN SOURCE:

- ⊖ [View MAX6803US44D3+T on WIN SOURCE](#)
- ⊖ [Maxim Integrated Information](#)

Optimize Your Supply Chain with WIN SOURCE Solutions

- ✓ Global Sourcing Solution
- ✓ Obsolete Management
- ✓ Cost Control Management
- ✓ Shortage Management
- ✓ Alternative Solution
- ✓ Excess Inventory Management