



**THE DATASHEET OF  
MAX873AESA+**





# Low-Power, Low-Drift, +2.5V/+5V/+10V Precision Voltage References

## General Description

The MAX873/MAX875/MAX876 precision 2.5V, 5V, and 10V references offer excellent accuracy and very low power consumption. Extremely low temperature drift combined with excellent line and load regulation permit stable operation over a wide range of electrical and environmental conditions. Operation for the MAX873 is guaranteed with a +4.5V supply, making the part ideal in systems running from a +5V  $\pm 10\%$  supply. Low 10Hz to 1kHz noise—typically 3.8 $\mu$ V<sub>RMS</sub>, 9 $\mu$ V<sub>RMS</sub>, and 18 $\mu$ V<sub>RMS</sub>, respectively, for the MAX873, MAX875, MAX876—make the parts suitable for 12-bit data-acquisition systems.

A TRIM pin facilitates adjustment of the reference voltage over a  $\pm 6\%$  range, using only a 100k $\Omega$  potentiometer. A voltage output proportional to temperature provides a source for temperature compensation circuits, temperature warning circuits, and other applications.

## Applications

12-Bit ADCs and DACs  
Digital Multimeters  
Portable Data-Acquisition Systems  
Low-Power Test Equipment

Pin Configuration appears at end of data sheet.

## Features

- ◆ MAX873/MAX875/MAX876  
+2.5V/+5V/+10V Outputs  
 $\pm 1.5\text{mV}/\pm 2.0\text{mV}/\pm 3.0\text{mV}$  (max) Initial Accuracy
- ◆ 7ppm/ $^{\circ}\text{C}$  (max) Temperature Coefficient
- ◆ 450 $\mu\text{A}$  (max) Quiescent Current
- ◆ Low Noise: 3.8 $\mu\text{Vp-p}$  (typ at 2.5V)
- ◆ Sources 10mA, Sinks 2mA
- ◆ 15ppm/mA Load Regulation (max)
- ◆ 4ppm/V Line Regulation (max)
- ◆ Wide Supply Voltage Range, +4.5V to +18V (MAX873)
- ◆ TEMP Output Proportional to Temperature

## Typical Operating Circuit

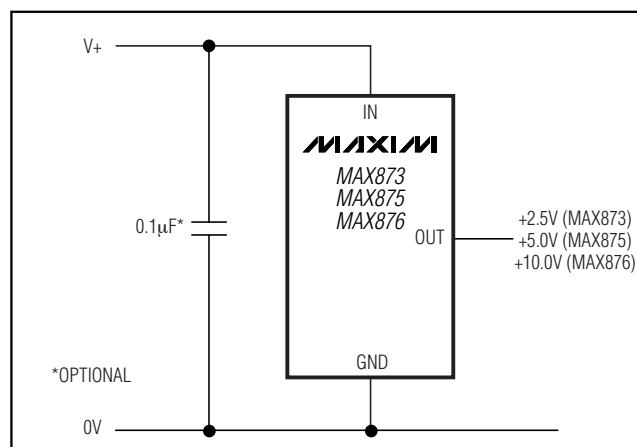

## Ordering Information/Selector Guide

PART	PIN-PACKAGE	OUTPUT VOLTAGE (V)	MAX TEMPCO (ppm/ $^{\circ}\text{C}$ )	INITIAL ACCURACY %	PKG CODE
MAX873AESA+	8 SO	2.500	7	$\pm 0.06$	S8-4
MAX873BESA+	8 SO	2.500	20	$\pm 0.10$	S8-4
MAX875AESA+	8 SO	5.000	7	$\pm 0.04$	S8-4
MAX875BESA+	8 SO	5.000	20	$\pm 0.06$	S8-4
MAX876AESA+	8 SO	10.000	7	$\pm 0.03$	S8-4
MAX876BESA+	8 SO	10.000	20	$\pm 0.05$	S8-4

+Denotes a lead-free package.

Note: All devices are specified over the  $-40^{\circ}\text{C}$  to  $+85^{\circ}\text{C}$  operating temperature range.



For pricing, delivery, and ordering information, please contact Maxim Direct at 1-888-629-4642, or visit Maxim's website at [www.maxim-ic.com](http://www.maxim-ic.com).

# Low-Power, Low-Drift, +2.5V/+5V/+10V Precision Voltage References

## ABSOLUTE MAXIMUM RATINGS

IN to GND .....-0.3V to +20V  
 OUT, TRIM, TEMP, TEST .....- 0.3V to (IN + 0.3V)  
 Output Short-Circuit Duration (to GND).....5s  
 Continuous Power Dissipation ( $T_A = +70^\circ\text{C}$ )  
 SO (derate 5.88mW/ $^\circ\text{C}$  above +70 $^\circ\text{C}$ ).....471mW

Operating Temperature Ranges:

MAX87\_E\_A .....-40 $^\circ\text{C}$  to +85 $^\circ\text{C}$   
 Storage Temperature Range .....-65 $^\circ\text{C}$  to +150 $^\circ\text{C}$   
 Lead Temperature (soldering, 10s) .....+300 $^\circ\text{C}$   
 Junction Temperature ( $T_J$ ) .....+150 $^\circ\text{C}$

Stresses beyond those listed under "Absolute Maximum Ratings" may cause permanent damage to the device. These are stress ratings only, and functional operation of the device at these or any other conditions beyond those indicated in the operational sections of the specifications is not implied. Exposure to absolute maximum rating conditions for extended periods may affect device reliability.

## ELECTRICAL CHARACTERISTICS—MAX873

( $V_{IN} = +5\text{V}$ ,  $I_L = 0\text{mA}$ ,  $C_{LOAD} < 100\text{pF}$ ,  $T_A = -40^\circ\text{C}$  to +85 $^\circ\text{C}$ , unless otherwise noted.)

PARAMETER	SYMBOL	CONDITIONS		MIN	TYP	MAX	UNITS	
Output Voltage	$V_{OUT}$	$T_A = +25^\circ\text{C}$	MAX873A (0.06%)	2.4985	2.5000	2.5015	V	
			MAX873B (0.10%)	2.4975	2.5000	2.5025		
Output-Voltage Drift (Note 1)	$TCV_{OUT}$	MAX873A			2	7	ppm/ $^\circ\text{C}$	
		MAX873B			5	20		
Output-Noise Voltage	$e_n$	$T_A = +25^\circ\text{C}$	0.1Hz to 10Hz		3.8		$\mu\text{V}_{P-P}$	
			10Hz to 1kHz		6.8		$\mu\text{V}_{RMS}$	
Line Regulation		$V_{IN} = 4.5\text{V}$ to 18V	$T_A = +25^\circ\text{C}$		1	4.0	ppm/V	
			$T_A = -40^\circ\text{C}$ to +85 $^\circ\text{C}$		2	6		
Load Regulation		$I_L = 0$ to 10mA (source)	$T_A = +25^\circ\text{C}$		3	15	ppm/mA	
			$T_A = -40^\circ\text{C}$ to +85 $^\circ\text{C}$		3	20		
			$I_L = 0$ to -1mA (sink)	$T_A = +25^\circ\text{C}$		100		900
				$T_A = -40^\circ\text{C}$ to +85 $^\circ\text{C}$		150		1900
Quiescent Supply Current	$I_Q$	$T_A = +25^\circ\text{C}$			300	450	$\mu\text{A}$	
		$T_A = -40^\circ\text{C}$ to +85 $^\circ\text{C}$			300	600		
Short-Circuit Output Current	$I_{SC}$	Output shorted to GND			60		mA	
$V_{OUT}$ Adjust Range					$\pm 100$		mV	
Long-Term Output Drift					50		ppm/kh	
<b>TEMP PIN</b>								
Voltage Output	$V_{TEMP}$	$T_A = +25^\circ\text{C}$			570		mV	
Temperature Sensitivity	$TCV_{TEMP}$				1.9		mV/ $^\circ\text{C}$	

## ELECTRICAL CHARACTERISTICS—MAX875

( $V_{IN} = +15\text{V}$ ,  $I_L = 0\text{mA}$ ,  $C_{LOAD} < 100\text{pF}$ ,  $T_A = -40^\circ\text{C}$  to +85 $^\circ\text{C}$ , unless otherwise noted.)

PARAMETER	SYMBOL	CONDITIONS		MIN	TYP	MAX	UNITS
Output Voltage	$V_{OUT}$	$T_A = +25^\circ\text{C}$	MAX875A (0.04%)	4.998	5.000	5.002	V
			MAX875B (0.06%)	4.997	5.000	5.003	
Output Voltage Drift (Note 1)	$TCV_{OUT}$	MAX875A			2	7	ppm/ $^\circ\text{C}$
		MAX875B			5	20	
Output-Noise Voltage	$e_n$	$T_A = +25^\circ\text{C}$	0.1Hz to 10Hz		9		$\mu\text{V}_{P-P}$
			10Hz to 1kHz		14.5		$\mu\text{V}_{RMS}$
Line Regulation		$V_{IN} = 7\text{V}$ to 18V	$T_A = +25^\circ\text{C}$		1	4.0	ppm/V
			$T_A = -40^\circ\text{C}$ to +85 $^\circ\text{C}$		2	6	

# Low-Power, Low-Drift, +2.5V/+5V/+10V Precision Voltage References

MAX873/MAX875/MAX876

## ELECTRICAL CHARACTERISTICS—MAX875 (continued)

( $V_{IN} = +15V$ ,  $I_L = 0mA$ ,  $C_{LOAD} < 100pF$ ,  $T_A = -40^{\circ}C$  to  $+85^{\circ}C$ , unless otherwise noted.)

PARAMETER	SYMBOL	CONDITIONS		MIN	TYP	MAX	UNITS
Load Regulation		$I_L = 0$ to 10mA (source)	$T_A = +25^{\circ}C$	3	15	ppm/mA	
			$T_A = -40^{\circ}C$ to $+85^{\circ}C$	3	20		
		$I_L = 0$ to -1mA (sink)	$T_A = +25^{\circ}C$	100	900		
			$T_A = -40^{\circ}C$ to $+85^{\circ}C$	150	1900		
Quiescent Supply Current	$I_Q$	$T_A = +25^{\circ}C$		320	550	$\mu A$	
		$T_A = -40^{\circ}C$ to $+85^{\circ}C$		320	700		
Short-Circuit Output Current	$I_{SC}$	Output shorted to GND		60		mA	
$V_{OUT}$ Adjust Range				$\pm 300$		mV	
Long-Term Output Drift				50		ppm/kh	
<b>TEMP PIN</b>							
Voltage Output	$V_{TEMP}$	$T_A = +25^{\circ}C$		630		mV	
Temperature Sensitivity	$TCV_{TEMP}$			2.1		mV/ $^{\circ}C$	

## ELECTRICAL CHARACTERISTICS—MAX876

( $V_{IN} = +15V$ ,  $I_L = 0mA$ ,  $C_{LOAD} < 100pF$ ,  $T_A = -40^{\circ}C$  to  $+85^{\circ}C$ , unless otherwise noted.)

PARAMETER	SYMBOL	CONDITIONS		MIN	TYP	MAX	UNITS
Output Voltage	$V_{OUT}$	$T_A = +25^{\circ}C$	MAX876A (0.03%)	9.997	10.000	10.003	V
			MAX876B (0.05%)	9.995	10.000	10.005	
Output Voltage Drift (Note 1)	$TCV_{OUT}$	MAX876A		2	7	ppm/ $^{\circ}C$	
		MAX876B		5	20		
Output-Noise Voltage	$e_n$	$T_A = +25^{\circ}C$	0.1Hz to 10Hz	18		$\mu V_{P-P}$	
			10Hz to 1kHz	29		$\mu V_{RMS}$	
Line Regulation		$V_{IN} = 12V$ to 18V	$T_A = +25^{\circ}C$	1	4.0	ppm/V	
			$T_A = -40^{\circ}C$ to $+85^{\circ}C$	1	6		
Load Regulation		$I_L = 0$ to 10mA (source)	$T_A = +25^{\circ}C$	1	15	ppm/mA	
			$T_A = -40^{\circ}C$ to $+85^{\circ}C$	1	20		
		$I_L = 0$ to -1mA (sink)	$T_A = +25^{\circ}C$	100	900		
			$T_A = -40^{\circ}C$ to $+85^{\circ}C$	150	1900		
Quiescent Supply Current	$I_Q$	$T_A = +25^{\circ}C$		320	550	$\mu A$	
		$T_A = -40^{\circ}C$ to $+85^{\circ}C$		340	700		
Short-Circuit Output Current	$I_{SC}$	Output shorted to GND		60		mA	
$V_{OUT}$ Adjust Range				$\pm 600$		mV	
Long-Term Output Drift				50		ppm/kh	
<b>TEMP PIN</b>							
Voltage Output	$V_{TEMP}$	$T_A = +25^{\circ}C$		630		mV	
Temperature Sensitivity	$TCV_{TEMP}$			2.1		mV/ $^{\circ}C$	

**Note 1:** Temperature coefficient is defined as maximum  $\Delta V_{OUT}$  divided by maximum  $\Delta T$  of the temperature range.

# Low-Power, Low-Drift, +2.5V/+5V/+10V Precision Voltage References

## Typical Operating Characteristics

( $V_{IN} = +5V$  for  $V_{OUT} = +2.5V$ ,  $V_{IN} = +15V$  for  $V_{OUT} = +10V$ ,  $I_{OUT} = 0$ ,  $T_A = +25^\circ C$ , unless otherwise noted.)

**OUTPUT VOLTAGE vs. TEMPERATURE**  
( $V_{OUT} = 2.5V$ )

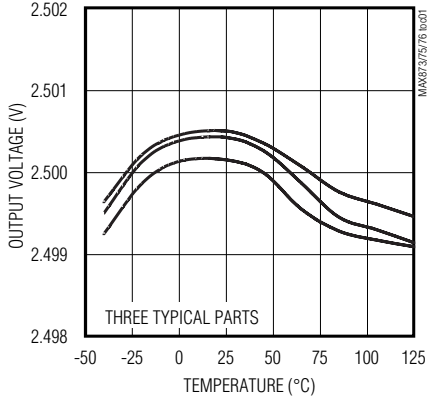

**OUTPUT VOLTAGE vs. TEMPERATURE**  
( $V_{OUT} = 10V$ )

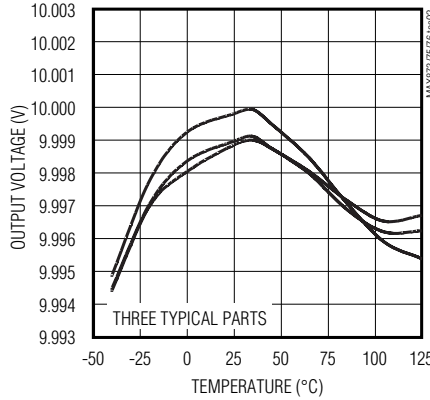

**LOAD REGULATION vs. SOURCE CURRENT**  
( $V_{OUT} = 2.5V$ )

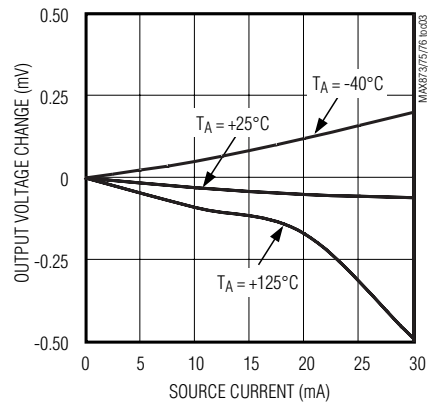

**LOAD REGULATION vs. SOURCE CURRENT**  
( $V_{OUT} = 10V$ )

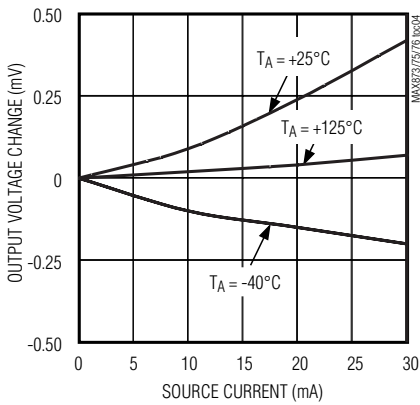

**LOAD REGULATION vs. SINK CURRENT**  
( $V_{OUT} = 2.5V$ )

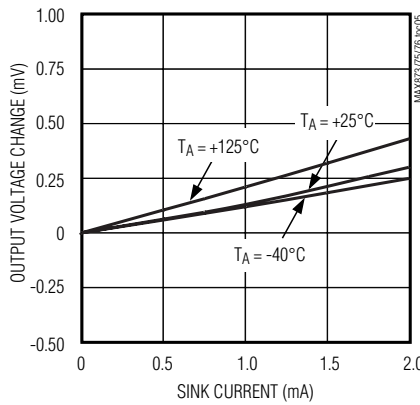

**LOAD REGULATION vs. SINK CURRENT**  
( $V_{OUT} = 10V$ )

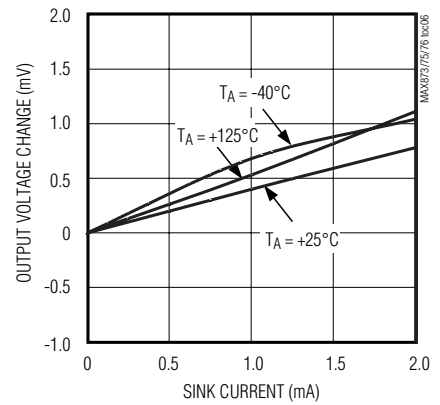

**LINE REGULATION vs. TEMPERATURE**  
( $V_{OUT} = 2.5V$ )

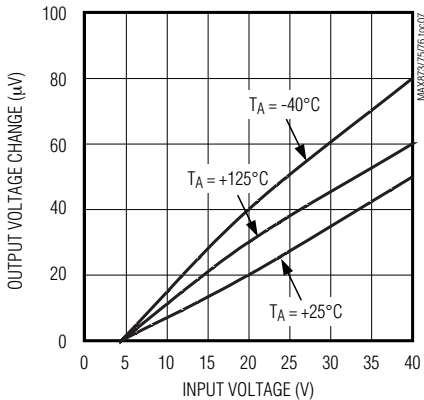

**LINE REGULATION vs. TEMPERATURE**  
( $V_{OUT} = 10V$ )

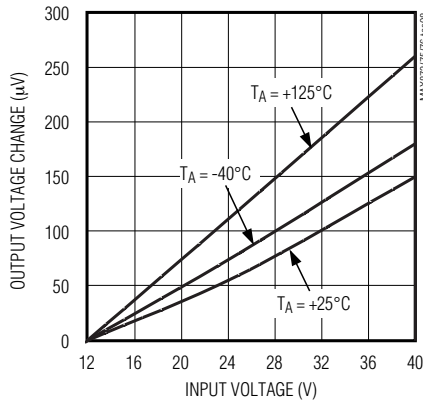

**MINIMUM INPUT-OUTPUT DIFFERENTIAL vs. SOURCE CURRENT**  
( $V_{OUT} = 2.5V$ )

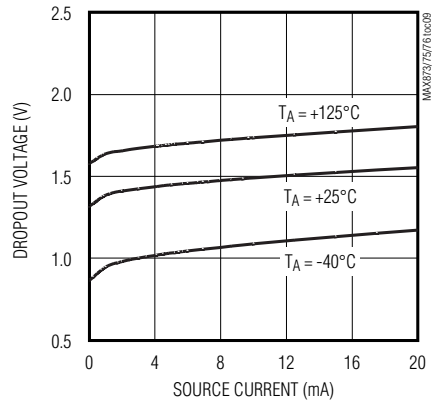

# Low-Power, Low-Drift, +2.5V/+5V/+10V Precision Voltage References

## Typical Operating Characteristics (continued)

( $V_{IN} = +5V$  for  $V_{OUT} = +2.5V$ ,  $V_{IN} = +15V$  for  $V_{OUT} = +10V$ ,  $I_{OUT} = 0$ ,  $T_A = +25^\circ C$ , unless otherwise noted.)

MAX873/MAX875/MAX876

**MINIMUM INPUT-OUTPUT DIFFERENTIAL vs. SOURCE CURRENT ( $V_{OUT} = 10V$ )**

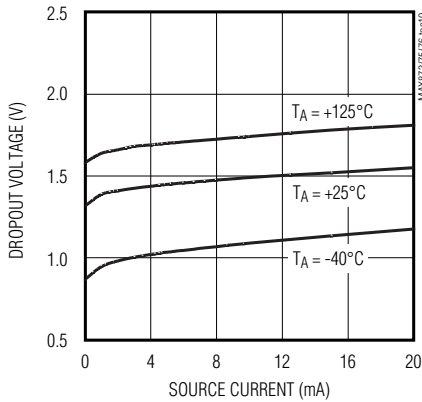

**POWER-SUPPLY REJECTION RATIO vs. FREQUENCY ( $V_{OUT} = 2.5V$ )**

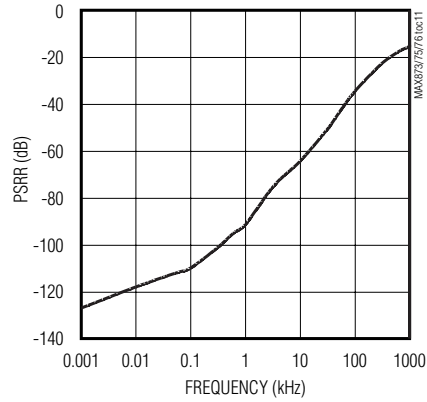

**POWER-SUPPLY REJECTION RATIO vs. FREQUENCY ( $V_{OUT} = 10V$ )**

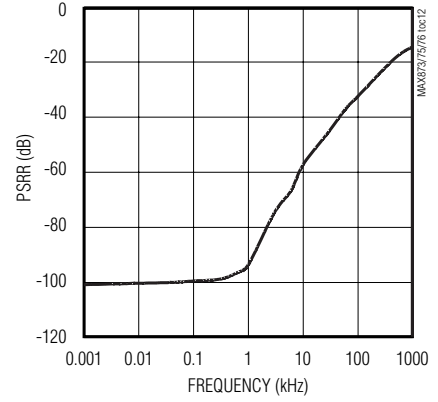

**OUTPUT IMPEDANCE vs. FREQUENCY ( $V_{OUT} = 2.5V$ )**

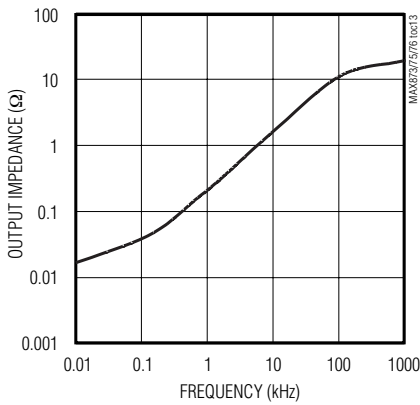

**SUPPLY CURRENT vs. INPUT VOLTAGE ( $V_{OUT} = 2.5V$ )**

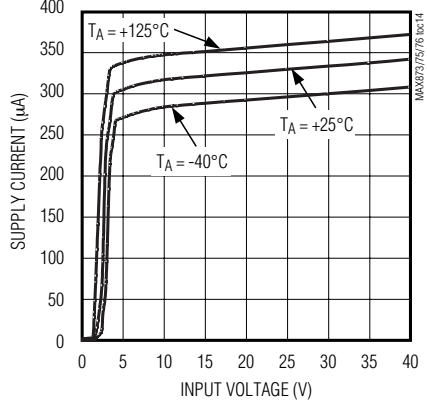

**SUPPLY CURRENT vs. INPUT VOLTAGE ( $V_{OUT} = 10V$ )**

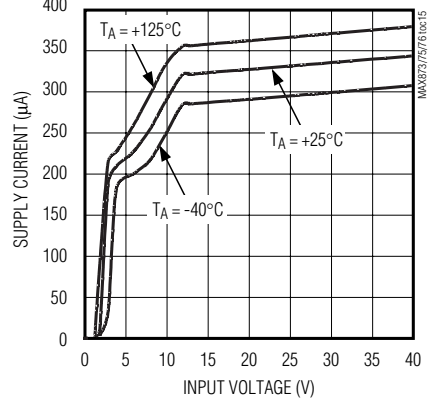

**SUPPLY CURRENT vs. TEMPERATURE ( $V_{OUT} = 2.5V$ )**

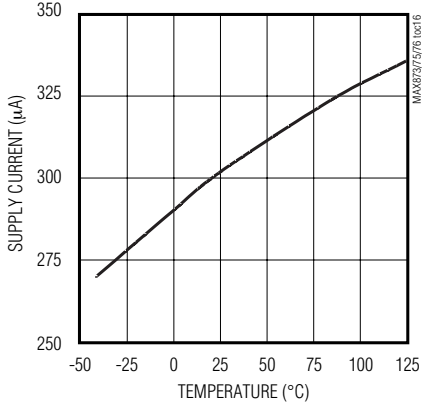

**SUPPLY CURRENT vs. TEMPERATURE ( $V_{OUT} = 10V$ )**

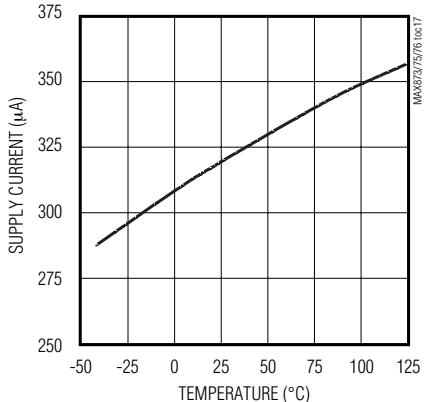

**TEMP VOLTAGE vs. TEMPERATURE ( $V_{OUT} = 2.5V$ )**

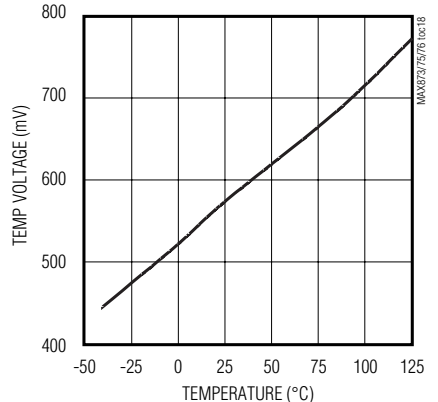

# Low-Power, Low-Drift, +2.5V/+5V/+10V Precision Voltage References

## Typical Operating Characteristics (continued)

( $V_{IN} = +5V$  for  $V_{OUT} = +2.5V$ ,  $V_{IN} = +15V$  for  $V_{OUT} = +10V$ ,  $I_{OUT} = 0$ ,  $T_A = +25^\circ C$ , unless otherwise noted.)

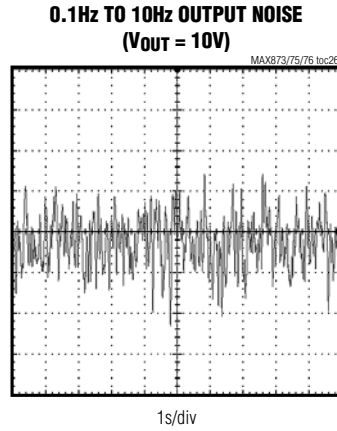
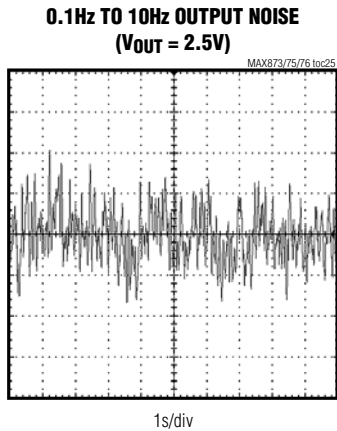
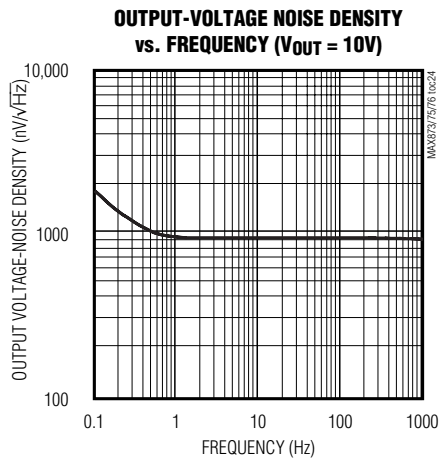
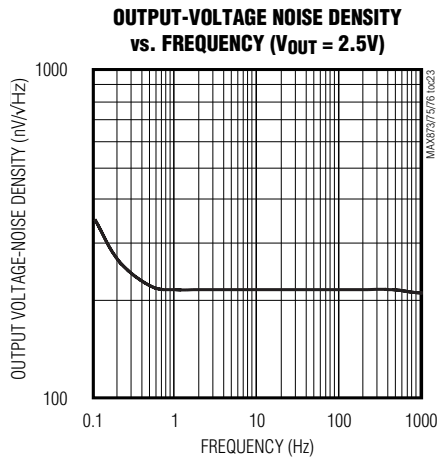
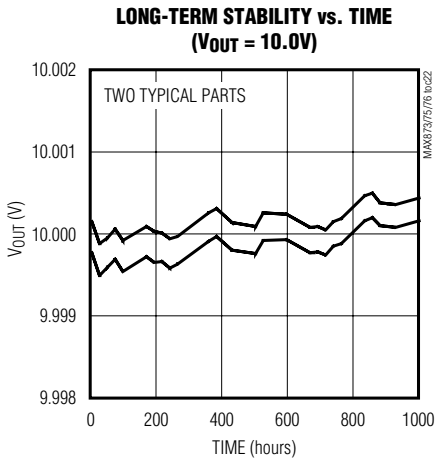
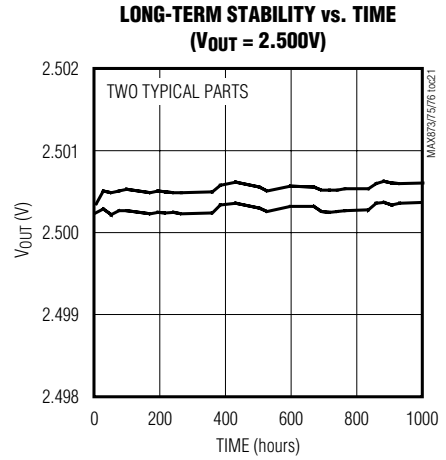
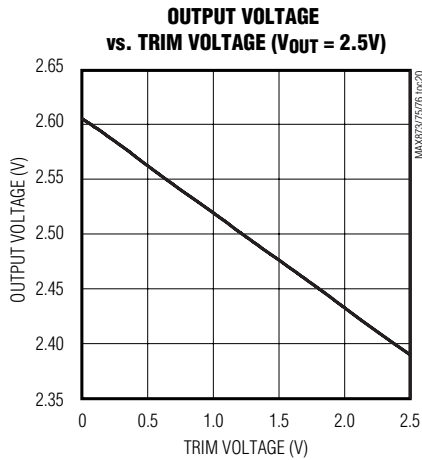
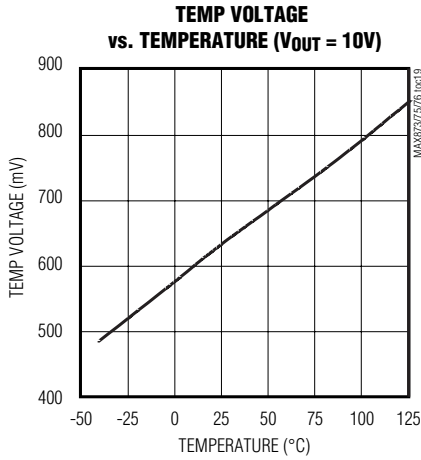

# Low-Power, Low-Drift, +2.5V/+5V/+10V Precision Voltage References

## Typical Operating Characteristics (continued)

( $V_{IN} = +5V$  for  $V_{OUT} = +2.5V$ ,  $V_{IN} = +15V$  for  $V_{OUT} = +10V$ ,  $I_{OUT} = 0$ ,  $T_A = +25^\circ C$ , unless otherwise noted.)

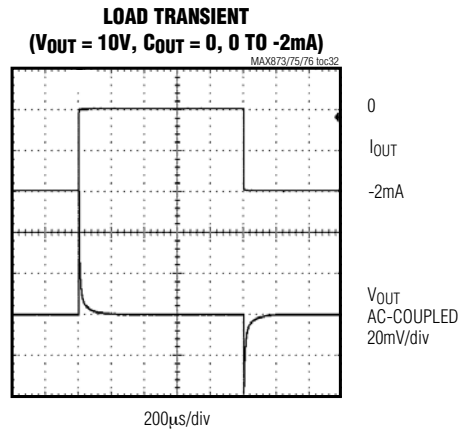
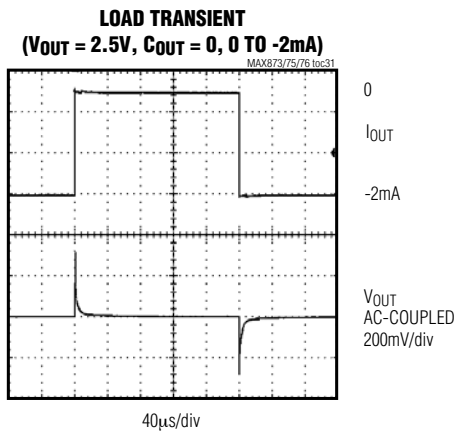
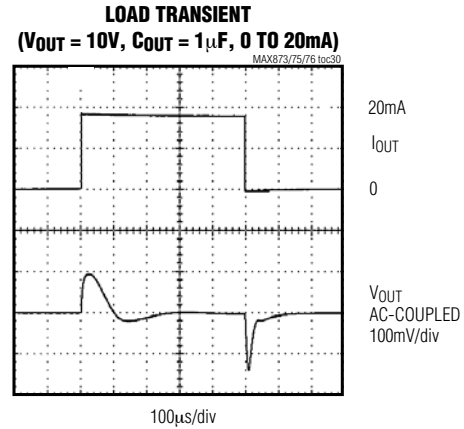
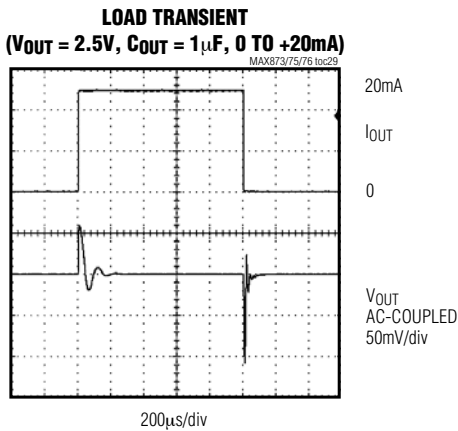
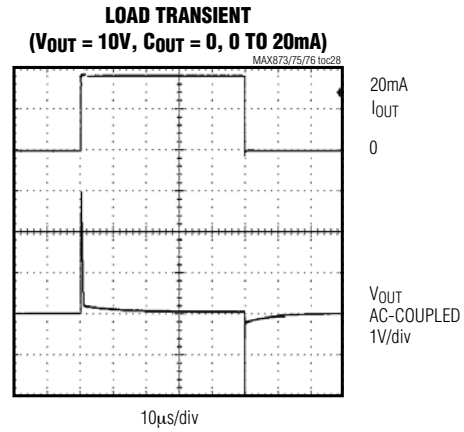
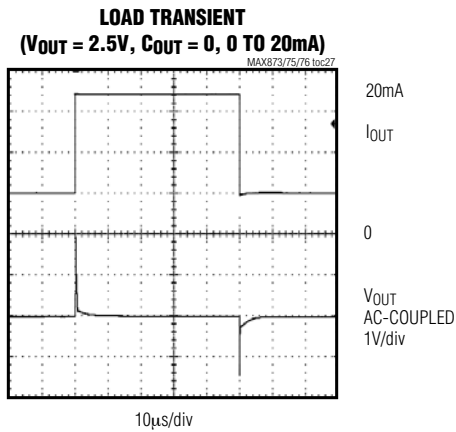

MAX873/MAX875/MAX876

# Low-Power, Low-Drift, +2.5V/+5V/+10V Precision Voltage References

## Typical Operating Characteristics (continued)

( $V_{IN} = +5V$  for  $V_{OUT} = +2.5V$ ,  $V_{IN} = +15V$  for  $V_{OUT} = +10V$ ,  $I_{OUT} = 0$ ,  $T_A = +25^\circ C$ , unless otherwise noted.)

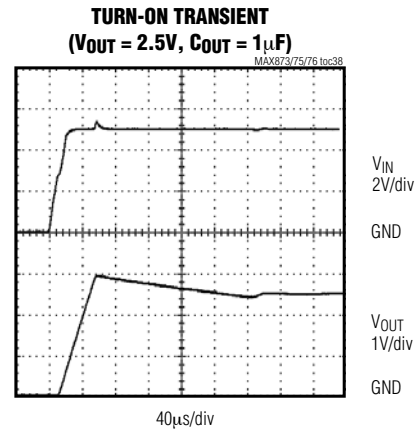
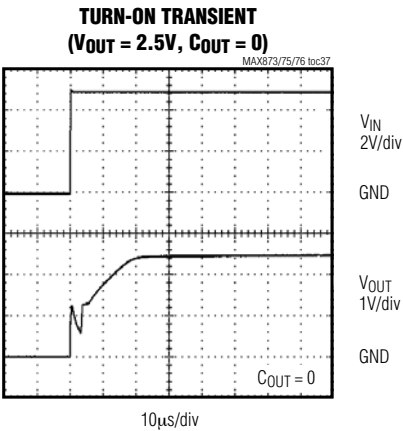
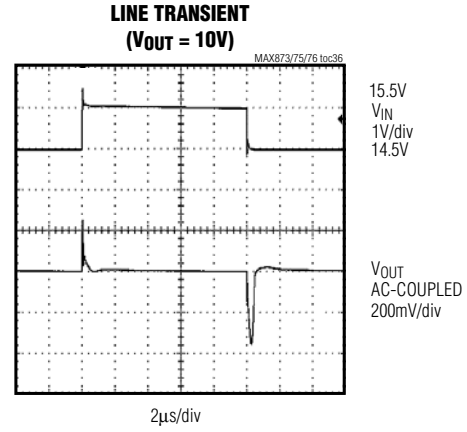
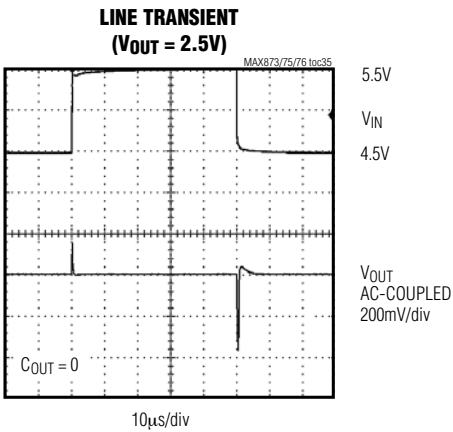
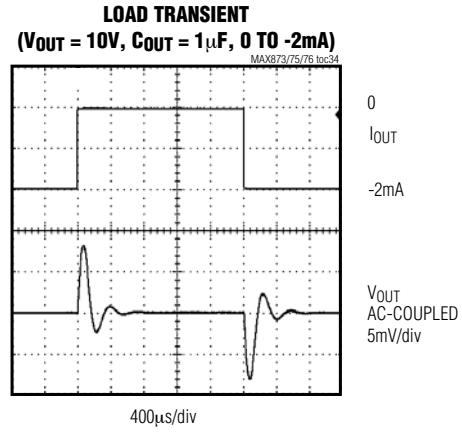
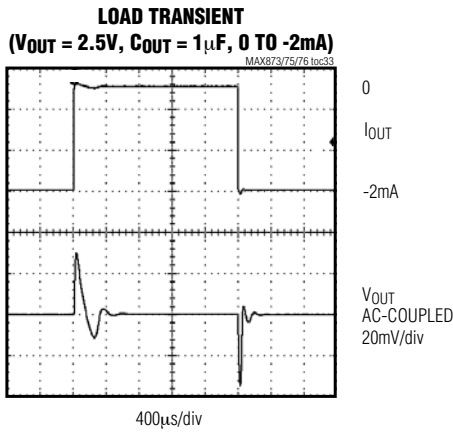

# Low-Power, Low-Drift, +2.5V/+5V/+10V Precision Voltage References

## Typical Operating Characteristics (continued)

( $V_{IN} = +5V$  for  $V_{OUT} = +2.5V$ ,  $V_{IN} = +15V$  for  $V_{OUT} = +10V$ ,  $I_{OUT} = 0$ ,  $T_A = +25^\circ C$ , unless otherwise noted.)

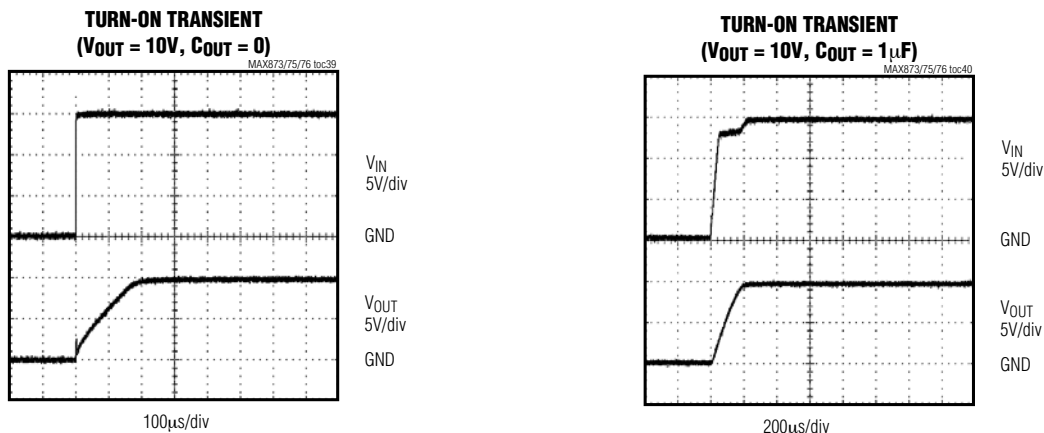

## Pin Description

PIN	NAME	FUNCTION
1, 8	I.C.	Internally Connected. Do not connect externally.
2	IN	Positive Power-Supply Input
3	TEMP	Temperature Proportional Output Voltage. TEMP generates an output voltage proportional to the die temperature.
4	GND	Ground
5	TRIM	Output Voltage Trim. Connect TRIM to the center of a voltage-divider between OUT and GND for trimming. Leave unconnected to use the preset output voltage.
6	OUT	Output Voltage
7	N.C.	No Connection. Not internally connected.

## Detailed Description

The MAX873/MAX875/MAX876 precision voltage references provide accurate preset +2.5V, +5.0V, and +10V reference voltages from up to +40V input voltages. These devices feature a proprietary temperature-coefficient curvature-correction circuit and laser-trimmed thin-film resistors that result in a very low 3ppm/ $^\circ C$  temperature coefficient and excellent 0.05% initial accuracy. The MAX873/MAX875/MAX876 draw 340µA of supply current and source 30mA or sink 2mA of load current.

### Trimming the Output Voltage

Trim the factory-preset output voltage on the MAX873/MAX875/MAX876 by placing a resistive divider network between OUT, TRIM, and GND.

Use the following formula to calculate the change in output voltage from its preset value:

$$\Delta V_{OUT} = 2 \times (V_{TRIM} - V_{TRIM (open)}) \times k$$

where:

$$V_{TRIM} = 0V \text{ to } V_{OUT}$$

$$V_{TRIM (open)} = V_{OUT (nominal)} / 2 \text{ (typ)}$$

$$k = \pm 6\% \text{ (typ)}$$

For example, use a 50kΩ potentiometer (such as the MAX5436) between OUT, TRIM, and GND with the potentiometer wiper connected to TRIM (see Figure 2). As the TRIM voltage changes from  $V_{OUT}$  to GND, the output voltage changes accordingly. Set R2 to 1MΩ or less. Currents through resistors R1 and R2 add to the quiescent supply current.

# Low-Power, Low-Drift, +2.5V/+5V/+10V Precision Voltage References

## Temp Output

The MAX873/MAX875/MAX876 provide a temperature output proportional to die temperature. TEMP can be calculated from the following formula:

$$\text{TEMP (V)} = T_J (\text{°K}) \times n$$

where  $T_J$  = the die temperature,

$n$  = the temperature multiplier,

$$n = \frac{V_{\text{TEMP}}(\text{at } T_J = T_0)}{T_0} \approx 1.9\text{mV/°K}$$

$T_A$  = the ambient temperature.

Self-heating affects the die temperature and conversely, the TEMP output. The TEMP equation assumes the output is not loaded. If device power dissipation is negligible, then  $T_J \approx T_A$ .

## Applications Information

### Bypassing/Output Capacitance

For the best line-transient performance, decouple the input with a 0.1 $\mu$ F ceramic capacitor as shown in the *Typical Operating Circuit*. Place the capacitor as close to IN as possible. When transient performance is less important, no capacitor is necessary.

The MAX873/MAX875/MAX876 do not require an output capacitor for stability and are stable with capacitive loads up to 100 $\mu$ F. In applications where the load or the

supply can experience step changes, a larger output capacitor reduces the amount of overshoot (undershoot) and improves the circuit's transient response. Place output capacitors as close to the devices as possible for best performance.

### Supply Current

The MAX873/MAX875/MAX876 consume 320 $\mu$ A (typ) of quiescent supply current. This improved efficiency reduces power dissipation and extends battery life.

### Thermal Hysteresis

Thermal hysteresis is the change in the output voltage at  $T_A = +25^\circ\text{C}$  before and after the device is cycled over its entire operating temperature range. Hysteresis is caused by differential package stress appearing across the bandgap core transistors. The typical thermal hysteresis value is 120ppm.

### Turn-On Time

The MAX873/MAX875/MAX876 typically turn on and settle to within 0.1% of the preset output voltage in 150 $\mu$ s (2.5V output). The turn-on time can increase up to 150 $\mu$ s with the device operating with a 1 $\mu$ F load.

### Short-Circuited Outputs

The MAX873/MAX875/MAX876 feature a short-circuit-protected output. Internal circuitry limits the output current to 60mA when short circuiting the output to ground. The output current is limited to 3mA when short circuiting the output to the input.

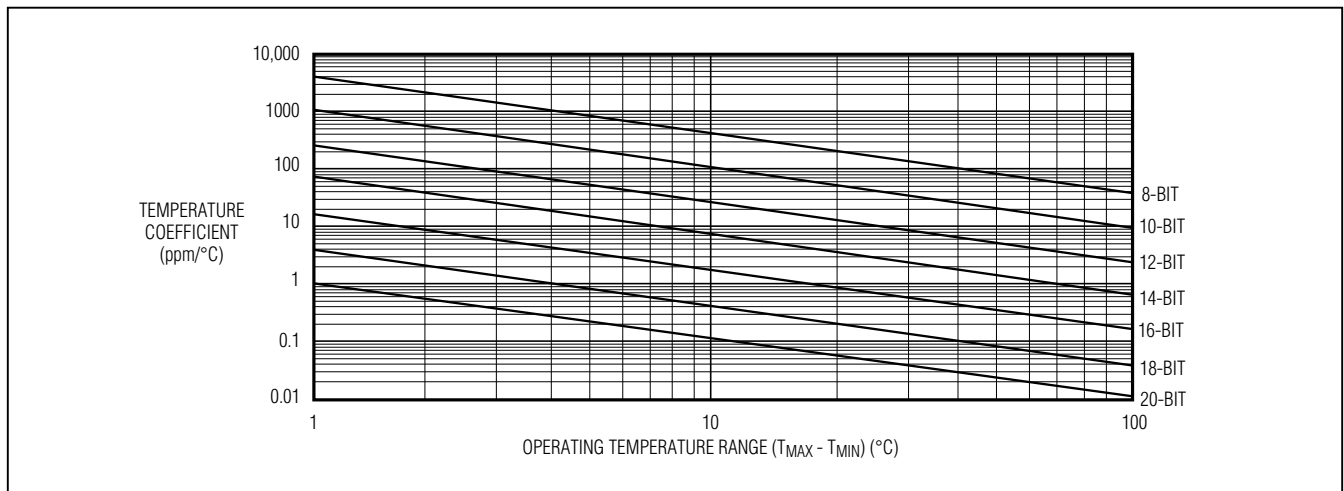

Figure 1. Temperature Coefficient vs. Operating Temperature Range for a 1 LSB Maximum Error

# Low-Power, Low-Drift, +2.5V/+5V/+10V Precision Voltage References

## Temperature Coefficient vs. Operating Temperature Range for a 1 LSB Maximum Error

In a data converter application, the reference voltage of the converter must stay within a certain limit to keep the error in the data converter smaller than the resolution limit through the operating temperature range. Figure 1 shows the maximum allowable reference-voltage temperature coefficient to keep the conversion error to less than 1 LSB, as a function of the operating temperature range ( $T_{MAX} - T_{MIN}$ ) with the converter resolution as a parameter. The graph assumes the reference-voltage temperature coefficient as the only parameter affecting accuracy.

In reality, the absolute static accuracy of a data converter is dependent on the combination of many parameters such as integral nonlinearity, differential nonlinearity, offset error, gain error, as well as voltage-reference changes.

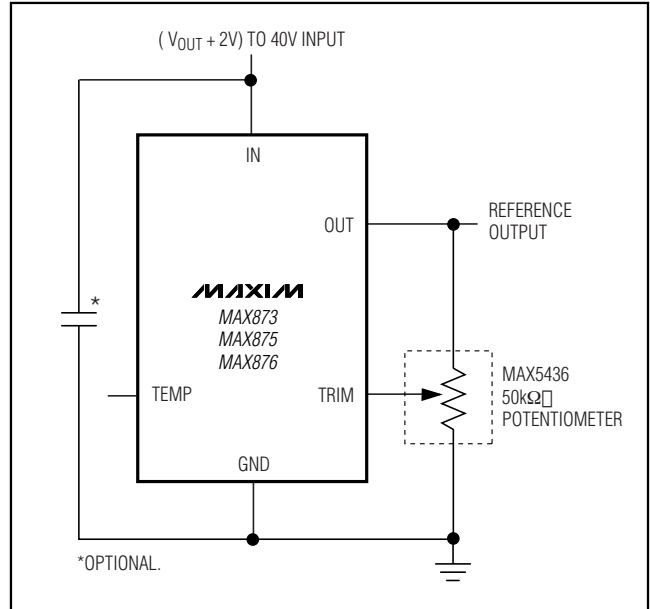
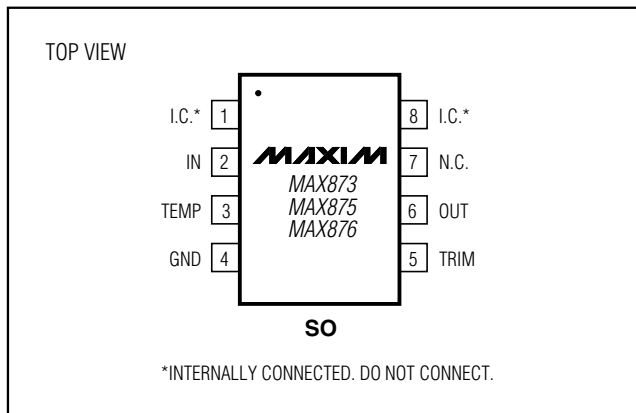

Figure 2. Applications Circuit Using the MAX5436 Potentiometer

## Pin Configuration



## Chip Information

TRANSISTOR COUNT: 429  
PROCESS: BICMOS

MAX873/MAX875/MAX876

# Low-Power, Low-Drift, +2.5V/+5V/+10V Precision Voltage References

## Package Information

(The package drawing(s) in this data sheet may not reflect the most current specifications. For the latest package outline information go to [www.maxim-ic.com/packages](http://www.maxim-ic.com/packages).)



DIM	INCHES		MILLIMETERS	
	MIN	MAX	MIN	MAX
A	0.053	0.069	1.35	1.75
A1	0.004	0.010	0.10	0.25
B	0.014	0.019	0.35	0.49
C	0.007	0.010	0.19	0.25
e	0.050 BSC		1.27 BSC	
E	0.150	0.157	3.80	4.00
H	0.228	0.244	5.80	6.20
L	0.016	0.050	0.40	1.27

VARIATIONS:

DIM	INCHES		MILLIMETERS		N	MS012
	MIN	MAX	MIN	MAX		
D	0.189	0.197	4.80	5.00	8	AA
D	0.337	0.344	8.55	8.75	14	AB
D	0.386	0.394	9.80	10.00	16	AC

NOTES:

1. D&E DO NOT INCLUDE MOLD FLASH.
2. MOLD FLASH OR PROTRUSIONS NOT TO EXCEED 0.15mm (.006").
3. LEADS TO BE COPLANAR WITHIN 0.10mm (.004").
4. CONTROLLING DIMENSION: MILLIMETERS.
5. MEETS JEDEC MS012.
6. N = NUMBER OF PINS.

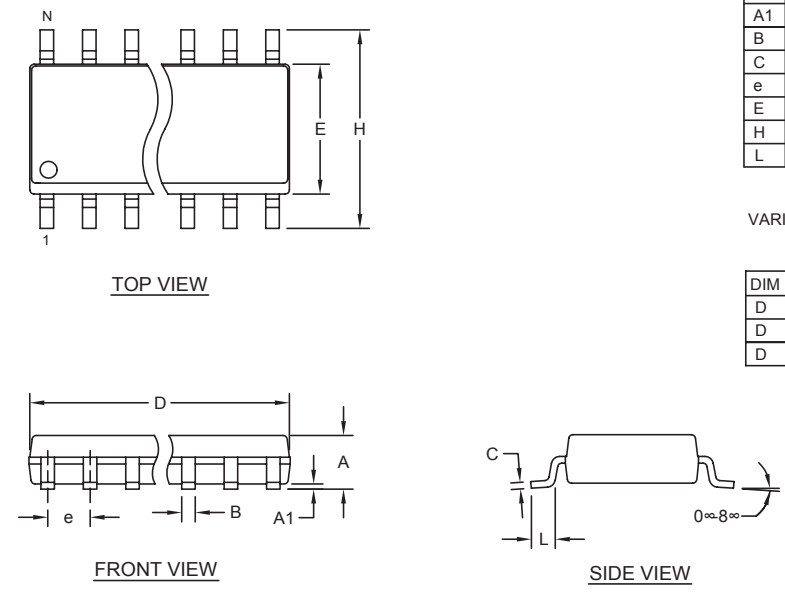

PROPRIETARY INFORMATION

TITLE:  
PACKAGE OUTLINE, .150" SOIC

APPROVAL	DOCUMENT CONTROL NO. 21-0041	REV. B	1/1
----------	---------------------------------	-----------	-----

## Revision History

Pages changed at Rev 3: 1-12

Maxim cannot assume responsibility for use of any circuitry other than circuitry entirely embodied in a Maxim product. No circuit patent licenses are implied. Maxim reserves the right to change the circuitry and specifications without notice at any time.

12 **Maxim Integrated Products, 120 San Gabriel Drive, Sunnyvale, CA 94086 408-737-7600**

## Looking for pricing, stock, or lifecycle information?

Click below to explore more details on WIN SOURCE:

- ⊖ [View MAX873AESA+ on WIN SOURCE](#)
- ⊖ [Maxim Integrated Information](#)

## Optimize Your Supply Chain with WIN SOURCE Solutions

- ✓ Global Sourcing Solution
- ✓ Obsolete Management
- ✓ Cost Control Management
- ✓ Shortage Management
- ✓ Alternative Solution
- ✓ Excess Inventory Management