



**THE DATASHEET OF  
DS1631S+T&R**



# DS1631/DS1631A/ DS1731

# High-Precision Digital Thermometer and Thermostat

## General Description

The DS1631, DS1631A, and DS1731 digital thermometers provide 9, 10, 11, or 12-bit temperature readings over a  $-55^{\circ}\text{C}$  to  $+125^{\circ}\text{C}$  range. The DS1631 and DS1631A thermometer accuracy is  $\pm 0.5^{\circ}\text{C}$  from  $0^{\circ}\text{C}$  to  $+70^{\circ}\text{C}$  with  $3.0\text{V} \leq V_{\text{DD}} \leq 5.5\text{V}$ , and the DS1731 accuracy is  $\pm 1^{\circ}\text{C}$  from  $-10^{\circ}\text{C}$  to  $+85^{\circ}\text{C}$  with  $3.0\text{V} \leq V_{\text{DD}} \leq 5.5\text{V}$ . The thermostat on all three devices provides custom hysteresis with user-defined trip points ( $T_{\text{H}}$  and  $T_{\text{L}}$ ). The  $T_{\text{H}}$  and  $T_{\text{L}}$  registers and thermometer configuration settings are stored in NV EEPROM so they can be programmed prior to installation. In addition, the DS1631A automatically begins taking temperature measurements at power-up, which allows it to function as a stand-alone thermostat.

Pin descriptions for the DS1631/DS1631A/DS1731 are provided in [Table 2](#) and user-accessible registers are summarized in [Table 3](#). A functional diagram is shown in [Figure 1](#).

## Applications

- Network Routers and Switches
- Cellular Base Stations
- Portable Products
- Any Space-Constrained Thermally Sensitive Product

## Benefits and Features

- Maximize System Accuracy in Broad Range of Thermal Management Applications
  - Operating Temperature Range:  $-55^{\circ}\text{C}$  to  $+125^{\circ}\text{C}$  ( $-67^{\circ}\text{F}$  to  $+257^{\circ}\text{F}$ )
  - DS1631 and DS1631A:  $\pm 0.5^{\circ}\text{C}$  Accuracy over  $0^{\circ}\text{C}$  to  $+70^{\circ}\text{C}$  Range
  - DS1731:  $\pm 1^{\circ}\text{C}$  Accuracy over a  $-10^{\circ}\text{C}$  to  $+85^{\circ}\text{C}$  Range
  - User-Selectable Output Resolution from 9 Bits to 12 Bits
- Reduce Cost with No External Components
- Simplify Distributed Temperature-Sensing Applications with Multidrop Capability
  - Up to Eight Devices Can Operate on a 2-Wire Bus
- Flexible and Nonvolatile User-Defined Thermostatic Modes with Custom Hysteresis
- Available in 8-Pin  $\mu\text{SOP}$  and SO (DS1631 and DS1631A Only) and the 8-Pin DIP (DS1631 Only) Packages

## Pin Configurations

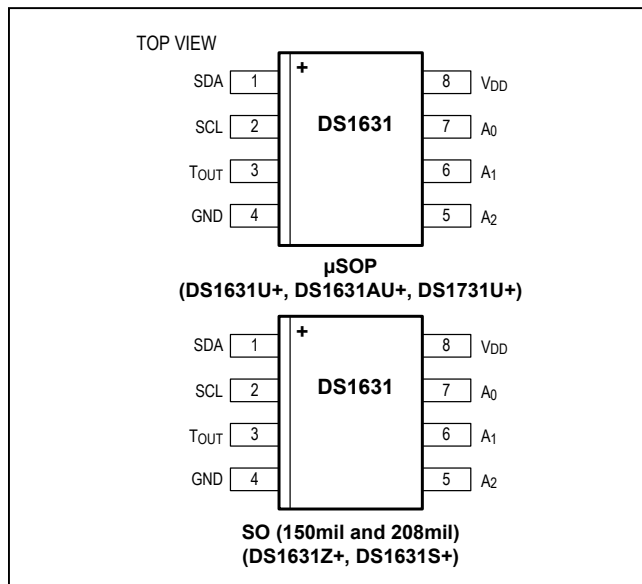

[Ordering Information](#) appears at end of data sheet.

See [Table 2](#) for Pin Descriptions.

### Absolute Maximum Ratings

Voltage on any Pin Relative to Ground.....	-0.5V to +6.0V	Solder Dip Temperature (10s).....	See IPC/JEDEC J-STD-020A Specification
Operating Temperature Range.....	-55°C to +125°C	Reflow Oven Temperature.....	+220°C
Storage Temperature Range.....	-55°C to +125°C		

\*These are stress ratings only and functional operation of the device at these or any other conditions above those indicated in the operation sections of this specification is not implied. Exposure to absolute maximum rating conditions for extended periods of time may affect reliability.

### DC Electrical Characteristics

(V<sub>DD</sub> = 2.7V to 5.5V; T<sub>A</sub> = -55°C to +125°C.)

PARAMETER	SYMBOL	CONDITION	MIN	MAX	UNITS
Supply Voltage	V <sub>DD</sub>	(Note 1)	2.7	5.5	V
DS1631, DS1631A Thermometer Error (Note 2)	T <sub>ERR</sub>	0°C to +70°C, 3.0V ≤ V <sub>DD</sub> ≤ 5.5V		±0.5	°C
		0°C to +70°C, 2.7V ≤ V <sub>DD</sub> < 3.0V		±1	
		-55°C to +125°C		±2	
DS1731 Thermometer Error (Note 2)	T <sub>ERR</sub>	-10°C to +85°C, 3.0V ≤ V <sub>DD</sub> ≤ 5.5V		±1	°C
		-10°C to +85°C, 2.7V ≤ V <sub>DD</sub> < 3.0V		±1.5	
		-55°C to +125°C		±2	
Low-Level Input Voltage	V <sub>IL</sub>		-0.5	0.3 x V <sub>DD</sub>	V
High-Level Input Voltage	V <sub>IH</sub>		0.7 x V <sub>DD</sub>	V <sub>DD</sub> + 0.3	V
SDA Low-Level Output Voltage	V <sub>OL1</sub>	3mA sink current	0	0.4	V
	V <sub>OL2</sub>	6mA sink current	0	0.6	
Input Current Each I/O Pin		0.4 < V <sub>I/O</sub> < 0.9V <sub>DD</sub>	-10	+10	µA
Active Supply Current (Note 3)	I <sub>DD</sub>	Temperature conversion -55°C to +85°C		1	mA
		Temperature conversion +85°C to +125°C		1.25	
		E <sup>2</sup> write		400	µA
		Communication only		110	
Standby Supply Current	I <sub>STBY</sub>	0°C to +70°C (Note 4)		800	nA
T <sub>OUT</sub> Output Logic Voltage	V <sub>OH</sub>	1mA source current (Note 1)	2.4		V
	V <sub>OL</sub>	4mA sink current (Note 1)		0.4	V

### AC Electrical Characteristics

( $V_{DD} = 2.7V$  to  $5.5V$ ;  $T_A = -55^{\circ}C$  to  $+125^{\circ}C$ .)

PARAMETER	SYMBOL	CONDITION	MIN	TYP	MAX	UNITS
Temperature Conversion Time	$t_{TC}$	9-bit resolution			93.75	ms
		10-bit resolution			187.5	
		11-bit resolution			375	
		12-bit resolution			750	
SCL Frequency	$f_{SCL}$		0		400	kHz
Bus Free Time Between a STOP and START Condition	$t_{BUF}$	(Note 5)	1.3			$\mu s$
START and Repeated START Hold Time from Falling SCL	$t_{HD:STA}$	(Note 5, 6)	0.6			$\mu s$
Low Period of SCL	$t_{LOW}$	(Note 5)	1.3			$\mu s$
High Period of SCL	$t_{HIGH}$	(Note 5)	0.6			$\mu s$
Repeated START Condition Setup Time to Rising SCL	$t_{SU:STA}$	(Note 5)	0.6			$\mu s$
Data-Out Hold Time from Falling SCL	$t_{HD:DAT}$	(Note 5)	0		0.9	$\mu s$
Data-In Setup Time to Rising SCL	$t_{SU:DAT}$	(Note 5)	100			ns
Rise Time of SDA and SCL	$t_R$	(Note 5, 7)	$20 + 0.1C_B$		1000	ns
Fall Time of SDA and SCL	$t_F$	(Note 5, 7)	$20 + 0.1C_B$		300	ns
STOP Setup Time to Rising SCL	$t_{SU:STO}$	(Note 5)	0.6			$\mu s$
Capacitive Load for Each Bus Line	$C_B$				400	pF
I/O Capacitance	$C_{I/O}$			10		pF
Input Capacitance	$C_I$			5		pF
Spike Pulse Width that can be Suppressed by Input Filter	$t_{SP}$		0		50	ns

**Note 1:** All voltages are referenced to GND.

**Note 2:** See [Figure 2](#) for Typical Operating Curves.

**Note 3:** Specified with  $T_{OUT}$  pin open;  $A_0, A_1, A_2 = 0V$  or  $V_{DD}$ ; and  $f_{SCL} \geq 2Hz$ .

**Note 4:** Specified with temperature conversions stopped;  $T_{OUT}$  pin open;  $SDA = V_{DD}$ ;  $SCL = V_{DD}$ ; and  $A_0, A_1, A_2 = 0V$  or  $V_{DD}$ .

**Note 5:** See Timing Diagram in [Figure 3](#). All timing is referenced to  $0.9 \times V_{DD}$  and  $0.1 \times V_{DD}$ .

**Note 6:** After this period the first clock pulse is generated.

**Note 7:** For example, if  $C_B = 300pF$ , then  $t_R[\min] = t_F[\min] = 50ns$ .

### EEPROM AC Electrical Characteristics

( $V_{DD} = 2.7V$  to  $5.5V$ ;  $T_A = -55^{\circ}C$  to  $+125^{\circ}C$ .)

PARAMETER	SYMBOL	CONDITION	MIN	TYP	MAX	UNITS
EEPROM Write Cycle Time	$t_{wr}$			4	10	ms
EEPROM Writes	$N_{EEWR}$	$-55^{\circ}C$ to $+55^{\circ}C$	50k			Writes
EEPROM Data Retention	$t_{EEDR}$	$-55^{\circ}C$ to $+55^{\circ}C$	10			Years

**Table 2. Detailed Pin Description**

PIN	SYMBOL	DESCRIPTION
1	SDA	Data Input/Output Pin for 2-Wire Serial Communication Port. Open-Drain.
2	SCL	Clock Input Pin for 2-Wire Serial Communication Port.
3	T <sub>OUT</sub>	Thermostat Output Pin. Push-Pull.
4	GND	Ground Pin
5	A <sub>2</sub>	Address Input Pin
6	A <sub>1</sub>	Address Input Pin
7	A <sub>0</sub>	Address Input Pin
8	V <sub>DD</sub>	Supply Voltage Pin. +2.7V to +5.5V Power-Supply Pin.

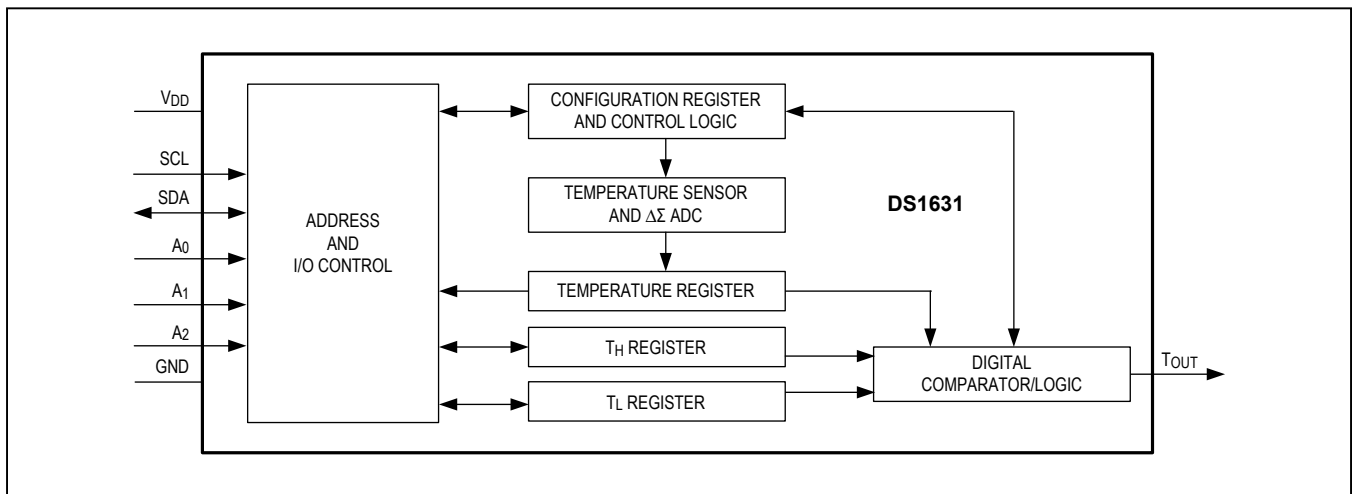

Figure 1. Functional Diagram

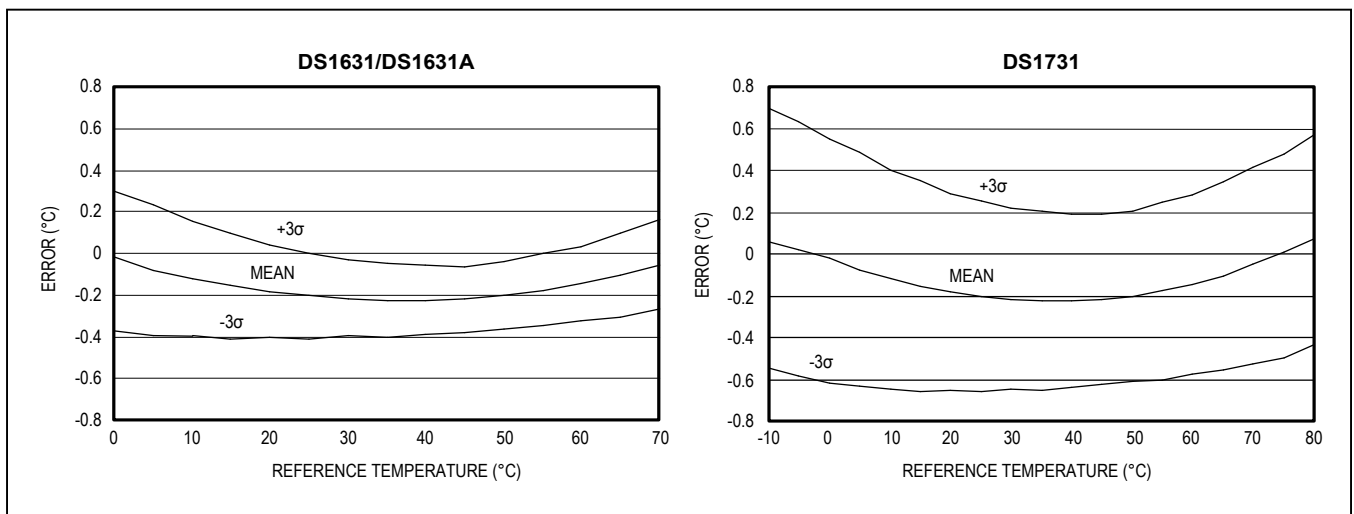

Figure 2. Typical Operating Curves

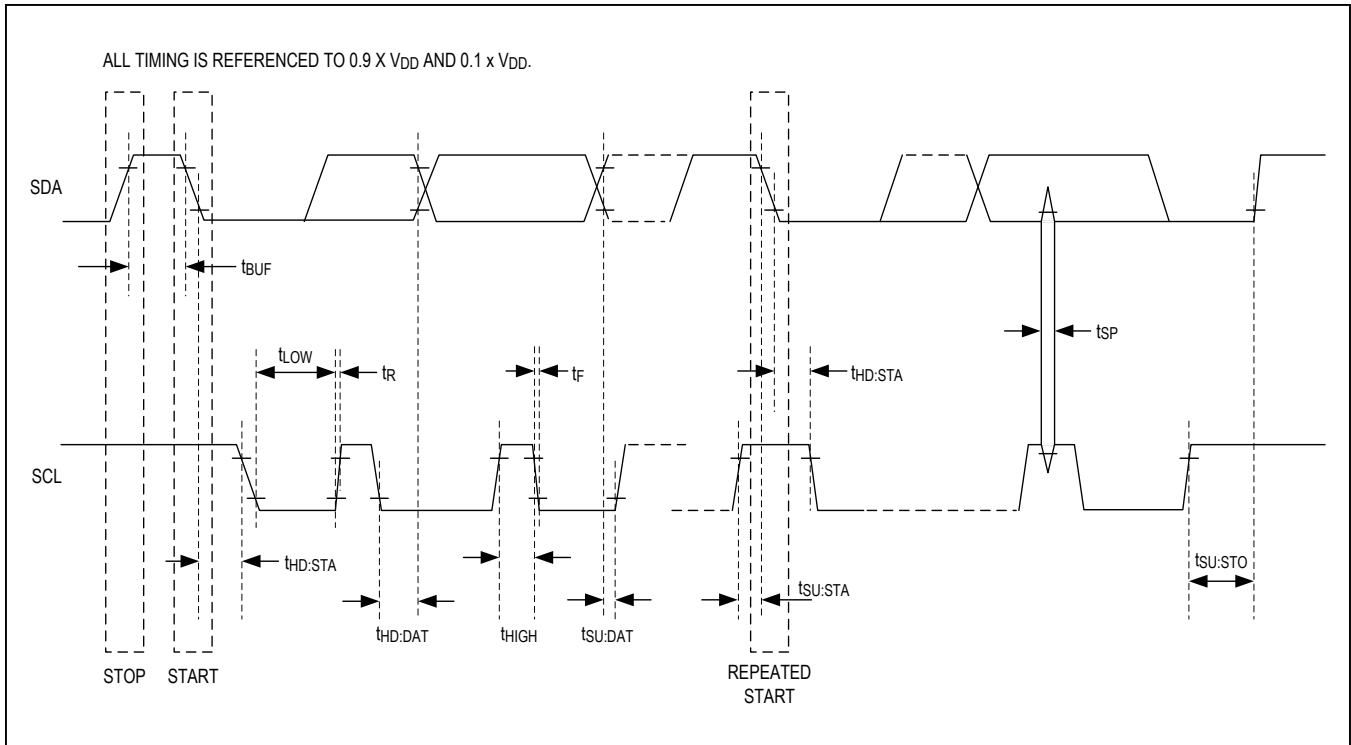

Figure 3. Timing Diagram

**Table 3. Register Summary**

REGISTER NAME (USER ACCESS)	SIZE (BYTES)	MEMORY TYPE	REGISTER CONTENTS AND POWER-UP STATE
Temperature (Read Only)	2	SRAM	Measured temperature in two's complement format. Power-up state: -60°C (1100 0100 0000 0000)
T <sub>H</sub> (Read/Write)	2	EEPROM	Upper alarm trip point in two's complement format. Factory state: 15°C (0000 1111 0000 0000)
T <sub>L</sub> (Read/Write)	2	EEPROM	Lower alarm trip point in two's complement format. Factory state: 10°C (0000 1010 0000 0000)
Configuration (Various bits are Read/Write and Read Only—See Table 5)	1	SRAM, EEPROM	Configuration and status information. Unsigned data. 6 MSbs = SRAM 2 LSbs (POL and 1SHOT bits) = EEPROM Power-up state: 100011XX (XX = user defined)

### Operation—Measuring Temperature

The DS1631, DS1631A, and DS1731 measure temperature using bandgap-based temperature sensors. A delta-sigma analog-to-digital converter (ADC) converts the measured temperature to a 9-, 10-, 11-, or 12-bit (user-selectable) digital value that is calibrated in °C; for °F applications a lookup table or conversion routine must be used. Throughout this data sheet, the term “conversion” is used to refer to the entire temperature measurement and ADC sequence.

The DS1631 and DS1731 always power-up in a low-power idle state, and the Start Convert T command must be used to initiate conversions. The DS1631A begins conversions automatically at power-up in the mode determined by the configuration register’s 1SHOT bit.

The DS1631, DS1631A, and DS1731 can be programmed to perform continuous consecutive conversions (continuous-conversion mode) or to perform single conversions on command (one-shot mode). The conversion mode is programmed through the 1SHOT bit in the configuration register as explained in the [Configuration Register](#) section of this data sheet. In continuous-conversion mode, the DS1631A begins performing continuous conversions immediately at power-up, and the DS1631 and DS1731 begin continuous conversions after a Start Convert T command is issued. For all three devices, consecutive conversions continue to be performed until a Stop Convert T command is issued, at which time the device goes into a low-power idle state. Continuous conversions can be restarted at any time using the Start Convert T command.

In one-shot mode the DS1631A performs a single conversion at power-up, and the DS1631 and DS1731 perform a single temperature conversion when a Start Convert T command is issued. For all three devices, when the conversion is complete the device enters a low-power idle state and remains in that state until a single temperature conversion is again initiated by a Start Convert T command.

The resolution of the output digital temperature data is user-configurable to 9, 10, 11, or 12 bits, corresponding to temperature increments of 0.5°C, 0.25°C, 0.125°C, and 0.0625°C, respectively. The default resolution at power-up is 12 bits, and it can be changed through the R0 and R1 bits in the configuration register. Note that the conversion time doubles for each additional bit of resolution.

After each conversion, the digital temperature is stored as a 16-bit two’s complement number in the two-byte temperature register as shown in [Figure 4](#). The sign bit (S) indicates if the temperature is positive or negative: for positive numbers S = 0 and for negative numbers S = 1. The Read Temperature command provides user access to the temperature register. Bits 3 through 0 of the temperature register are hardwired to 0. When the device is configured for 12-bit resolution, the 12 MSBs (bits 15 through 4) of the temperature register contain temperature data. For 11 bit resolution, the 11 MSBs (bits 15 through 5) of the temperature register contain data, and bit 4 is 0. Likewise, for 10-bit resolution, the 10 MSBs (bits 15 through 6) contain data, and for 9-bit the 9 MSBs (bits 15 through 7) contain data, and all unused LSBs contain 0s. [Table 4](#) gives examples of 12-bit resolution output data and the corresponding temperatures.

**Table 4. 12-Bit Resolution Temperature/ Data Relationship**

TEMPERATURE (°C)	DIGITAL OUTPUT (BINARY)	DIGITAL OUTPUT (HEX)
+125	0111 1101 0000 0000	7D00h
+25.0625	0001 1001 0001 0000	1910h
+10.125	0000 1010 0010 0000	0A20h
+0.5	0000 0000 1000 0000	0080h
0	0000 0000 0000 0000	0000h
-0.5	1111 1111 1000 0000	FF80h
-10.125	1111 0101 1110 0000	F5E0h
-25.0625	1110 0110 1111 0000	E6F0h
-55	1100 1001 0000 0000	C900h

	BIT 15	BIT 14	BIT 13	BIT 12	BIT 11	BIT 10	BIT 9	BIT 8
MS BYTE	S	2 <sup>6</sup>	2 <sup>5</sup>	2 <sup>4</sup>	2 <sup>3</sup>	2 <sup>2</sup>	2 <sup>1</sup>	2 <sup>0</sup>
	BIT 7	BIT 6	BIT 5	BIT 4	BIT 3	BIT 2	BIT 1	BIT 0
LS BYTE	2 <sup>-1</sup>	2 <sup>-2</sup>	2 <sup>-3</sup>	2 <sup>-4</sup>	0	0	0	0

Figure 4. Temperature, T<sub>H</sub>, and T<sub>L</sub> Register Format

### Operation—Thermostat Function

The thermostat output ( $T_{OUT}$ ) is updated after every temperature conversion, based on a comparison between the measured digital temperature and user-defined upper and lower thermostat trip points.  $T_{OUT}$  remains at the updated value until the next conversion completes. When the measured temperature meets or exceeds the value stored in the upper trip-point register ( $T_H$ ),  $T_{OUT}$  becomes active and remains active until the measured temperature falls below the value stored in the lower trip-point register ( $T_L$ ) (see Figure 5). This allows the user to program any amount of hysteresis into the output response. The active state of  $T_{OUT}$  is user-programmable through the polarity bit (POL) in the configuration register.

The user-defined values in the  $T_H$  and  $T_L$  registers (see Figure 4) must be in two's complement format with the MSb (bit 15) containing the sign bit (S). The  $T_H$  and  $T_L$  resolution is determined by the R0 and R1 bits in the configuration register (see Table 6), so the  $T_H$  and  $T_L$  resolution matches the output temperature resolution. For example, for 10-bit resolution bits 5 through 0 of the  $T_H$  and  $T_L$  registers read out as 0 (even if 1s are written to these bits), and the converted temperature is compared to the 10 MSBs of  $T_H$  and  $T_L$ .

The  $T_H$  and  $T_L$  registers are stored in EEPROM; therefore, they are NV and can be programmed prior to device installation. Writing to and reading from the  $T_H$  and  $T_L$  registers is achieved using the Access  $T_H$  and Access  $T_L$  commands. When making changes to the  $T_H$  and  $T_L$  registers, conversions should first be stopped using the Stop Convert T command if the device is in continuous conversion mode. Note that if the thermostat function is not used, the  $T_H$  and  $T_L$  registers can be used as general-purpose NV memory.

Another thermostat feature is the temperature high and low flags (THF and TLF) in the configuration register. These bits provide a record of whether the temperature has been greater than  $T_H$  or less than  $T_L$  at anytime since the device was powered up. These bits power up as 0s, and if the temperature ever exceeds the  $T_H$  register value, the THF bit is set to 1, or if the temperature ever falls below the  $T_L$  value, the TLF bit is set to 1. Once THF and/or TLF has been set, it remains set until overwritten with a 0 by the user or until the power is cycled.

### DS1631A Stand-Alone Thermostat Operation

Since the DS1631A automatically begins taking temperature measurements at power-up, it can function as a standalone thermostat (i.e., it can provide thermostatic operation without microcontroller communication). For standalone operation, the NV  $T_H$  and  $T_L$  registers and the POL and 1SHOT bits in the configuration register should be programmed to the desired values prior to installation. Since the default conversion resolution at power-up is 12 bits (R1 = 1 and R0 = 1 in the configuration register), the conversion resolution is always 12 bits during standalone thermostat operation.

### Configuration Register

The configuration register allows the user to program various DS1631 options such as conversion resolution, TOUT polarity, and operating mode. It also provides information to the user about conversion status, EEPROM activity, and thermostat activity. The configuration register is arranged as shown in Figure 6 and detailed descriptions of each bit are provided in Table 5. This register can be read from and written to using the Access Config command. When writing to the configuration register, conversions should first be stopped using the Stop Convert T command if the device is in continuous conversion mode. Note that the POL and 1SHOT bits are stored in EEPROM so they can be programmed prior to installation is desired. All other configuration register bits are SRAM and power up in the state shown in Table 5.

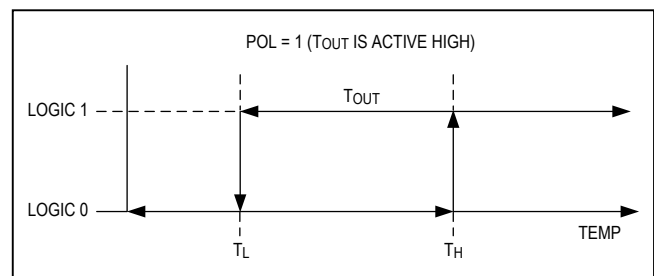

Figure 5. Thermostat Output Operation

MSB	BIT 6	BIT 5	BIT 4	BIT 3	BIT 2	BIT 1	LSB
DONE	THF	TLF	NVB	R1	R0	POL*	1SHOT*
*NV (EEPROM)							

Figure 6. Configuration Register

**Table 5. Configuration Register Bit Descriptions**

BIT NAME (USER ACCESS)	FUNCTIONAL DESCRIPTION
DONE—Temperature Conversion Done (Read Only)	Power-up state = 1. DONE = 0. Temperature conversion is in progress. DONE = 1. Temperature conversion is complete.
THF—Temperature High Flag (Read/Write)	Power-up state = 0. THF = 0. The measured temperature has not exceeded the value stored in the T <sub>H</sub> register since power-up. THF = 1. At some point since power-up the measured temperature has been higher than the value stored in the T <sub>H</sub> register. THF remains a 1 until it is overwritten with a 0 by the user, the power is cycled, or a Software POR command is issued.
TLF—Temperature Low Flag (Read/Write)	Power-up state = 0. TLF = 0. The measured temperature has not been lower than the value stored in the T <sub>L</sub> register since power-up. TLF = 1. At some point since power-up the measured temperature has been lower than the value stored in the T <sub>L</sub> register. TLF remains a 1 until it is overwritten with a 0 by the user, the power is cycled, or a Software POR command is issued.
NVB—NV Memory Busy (Read Only)	Power-up state = 0. NVB = 1. A write to EEPROM memory is in progress. NVB = 0. NV memory is not busy.
R1—Resolution Bit 1 (Read/Write)	Power-up state = 1. Sets conversion, T <sub>H</sub> , and T <sub>L</sub> resolution (see Table 6).
R0—Resolution Bit 0 (Read/Write)	Power-up state = 1. Sets conversion, T <sub>H</sub> , and T <sub>L</sub> resolution (see Table 6).
POL*—T <sub>OUT</sub> Polarity (Read/Write)	Power-up state = last value written to this bit. Factory setting = 0. POL = 1. T <sub>OUT</sub> is active high. POL = 0. T <sub>OUT</sub> is active low.
1SHOT*—Conversion Mode (Read/Write)	Power-up state = last value written to this bit. Factory setting = 0. 1SHOT = 1. One-Shot Mode. The Start Convert T command initiates a single temperature conversion and then the device goes into a low-power standby state. 1SHOT = 0. Continuous Conversion Mode. The Start Convert T command initiates continuous temperature conversions.

\*Stored in EEPROM

**Table 6. Resolution Configuration**

R1	R0	RESOLUTION (BIT)	CONVERSION TIME (MAX)
0	0	9	93.75ms
0	1	10	187.5ms
1	0	11	375ms
1	1	12	750ms

## 2-Wire Serial Data Bus

The DS1631, DS1631A, and DS1731 communicate over a bidirectional 2-wire serial data bus that consists of a serial clock (SCL) signal and serial data (SDA) signal. The DS1631, DS1631A, and DS1731 interface to the bus through their SCL input pins and open-drain SDA I/O pins.

The following terminology is used to describe 2-wire communication:

**Master Device:** Microprocessor/microcontroller that controls the slave devices on the bus. The master device generates the SCL signal and START and STOP conditions.

**Slave:** All devices on the bus other than the master. The DS1631, DS1631A, and DS1731 always function as slaves.

**Bus Idle or Not Busy:** Both SDA and SCL remain high. SDA is held high by a pullup resistor when the bus is idle, and SCL must either be forced high by the master (if the SCL output is push-pull) or pulled high by a pullup resistor (if the SCL output is open-drain).

**Transmitter:** A device (master or slave) that is sending data on the bus.

**Receiver:** A device (master or slave) that is receiving data from the bus.

**START Condition:** Signal generated by the master to indicate the beginning of a data transfer on the bus. The master generates a START condition by pulling SDA from high to low while SCL is high (see Figure 8). A “repeated” START is sometimes used at the end of a data transfer (instead of a STOP) to indicate that the master will perform another operation.

**STOP Condition:** Signal generated by the master to indicate the end of a data transfer on the bus. The master generates a STOP condition by transitioning SDA from low to high while SCL is high (see Figure 8). After the STOP is issued, the master releases the bus to its idle state.

**Acknowledge (ACK):** When a device is acting as a receiver, it must generate an acknowledge (ACK) on the SDA line after receiving every byte of data. The receiving device performs an ACK by pulling the SDA line low

for an entire SCL period (see Figure 8). During the ACK clock cycle, the transmitting device must release SDA. A variation on the ACK signal is the “not acknowledge” (NACK). When the master device is acting as a receiver, it uses a NACK instead of an ACK after the last data byte to indicate that it is finished receiving data. The master indicates a NACK by leaving the SDA line high during the ACK clock cycle.

**Slave Address:** Every slave device on the bus has a unique 7-bit address that allows the master to access that device. The 7-bit bus address is 1 0 0 1 A<sub>2</sub> A<sub>1</sub> A<sub>0</sub>, where A<sub>2</sub>, A<sub>1</sub>, and A<sub>0</sub> are user-selectable through the corresponding input pins. The three address pins allow up to eight DS1631s, DS1631As, or DS1731s to be multiplexed on the same bus.

**Control Byte:** The control byte is transmitted by the master and consists of the 7-bit slave address plus a read/write (R/W) bit (see Figure 7). If the master is going to read data from the slave device then R/W = 1, and if the master is going to write data to the slave device then R/W = 0.

**Command Byte:** The command byte can be any of the command protocols described in the [Command Set](#) section of this data sheet.

BIT 7	BIT 6	BIT 5	BIT 4	BIT 3	BIT 2	BIT 1	BIT 0
1	0	0	1	A <sub>2</sub>	A <sub>1</sub>	A <sub>0</sub>	R/W

Figure 7. Control Byte

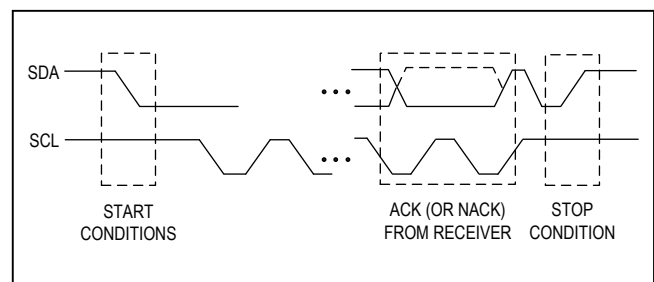

Figure 8. START, STOP, and ACK signals

## General 2-Wire Information

- All data is transmitted MSb first over the 2-wire bus.
- One bit of data is transmitted on the 2-wire bus each SCL period.
- A pullup resistor is required on the SDA line and, when the bus is idle, both SDA and SCL must remain in a logic-high state.
- All bus communication must be initiated with a START condition and terminated with a STOP condition. During a START or STOP is the only time SDA is allowed to change states while SCL is high. At all other times, changes on the SDA line can only occur when SCL is low: SDA must remain stable when SCL is high.
- After every 8-bit (1-byte) transfer, the receiving device must answer with an ACK (or NACK), which takes one SCL period. Therefore, nine clocks are required for every one-byte data transfer.

## Initiating 2-Wire Communication

To initiate 2-wire communication, the master generates a START followed by a control byte containing the DS1631, DS1631A, or DS1731 slave address. The R/W bit of the control byte must be a 0 (“write”) since the master next writes a command byte. The DS1631/DS1631A/DS1731 responds with an ACK after receiving the control byte. This must be followed by a command byte from the master, which indicates what type of operation is to be performed. The DS1631/DS1631A/DS1731 again respond with an ACK after receiving the command byte.

If the command byte is a Start Convert T or Stop Convert T command (see [Figure 9](#)), the transaction is finished, and the master must issue a STOP to signal the end of the communication sequence. If the command byte indicates a write or read operation, additional actions must occur as explained in the following sections.

## 2-Wire Writes

The master can write data to the DS1631/DS1631A/DS1731 by issuing an Access Config, Access T<sub>H</sub>, or Access T<sub>L</sub> command following the control byte (see [Figures 9b and 9d](#)). Since the R/W bit in the control byte was a 0 (“write”), the DS1631/DS1631A/DS1731 are already prepared to receive data. Therefore, after receiving an ACK in response to the command byte, the master device can immediately begin transmitting data. When writing to the configuration register, the master must send one byte of data, and when writing to the T<sub>H</sub> or T<sub>L</sub> registers the master must send two bytes of data. After receiving each data byte, the DS1631/DS1631A/DS1731 respond with an ACK, and the transaction is finished with a STOP from the master.

## 2-Wire Reads

The master can read data from the DS1631/DS1631A/DS1731 by issuing an Access Config, Access T<sub>H</sub>, Access T<sub>L</sub>, or Read Temperature command following the control byte (see [Figures 9c and 9e](#)). After receiving an ACK in response to the command, the master must generate a repeated START followed by a control byte with the same slave address as the first control byte. However, this time the R/W bit must be a 1, which tells the DS1631/DS1631A/DS1731 that a “read” is being performed. After the DS1631/DS1631A/DS1731 send an ACK in response to this control byte, it begins transmitting the requested data on the next clock cycle. One byte of data will be transmitted when reading from the configuration register after which the master must respond with a NACK followed by a STOP. For two-byte reads (i.e., from the Temperature, T<sub>H</sub>, or T<sub>L</sub> register), the master must respond to the first data byte with an ACK and to the second byte with a NACK followed by a STOP. If only the most significant byte of data is needed, the master can issue a NACK followed by a STOP after reading the first data byte.

## Command Set

The DS1631/DS1631A/DS1731 command set is detailed below:

### Start Convert T [ 51h ]

Initiates temperature conversions. If the part is in one-shot mode (1SHOT = 1), only one conversion is performed. In continuous mode (1SHOT = 0), continuous temperature conversions are performed until a Stop Convert T command is issued.

### Stop Convert T [ 22h ]

Stops temperature conversions when the device is in continuous conversion mode (1SHOT = 0).

### Read Temperature [ AAh ]

Reads last converted temperature value from the 2-byte temperature register.

### Access TH [ A1h ]

Reads or writes the 2-byte T<sub>H</sub> register.

### Access TL [ A2h ]

Reads or writes the 2-byte T<sub>L</sub> register.

### Access Config [ ACh ]

Reads or writes the 1-byte configuration register.

### Software POR [ 54h ]

Initiates a software power-on-reset (POR), which stops temperature conversions and resets all registers and logic to their power-up states. The software POR allows the user to simulate cycling the power without actually powering down the device.

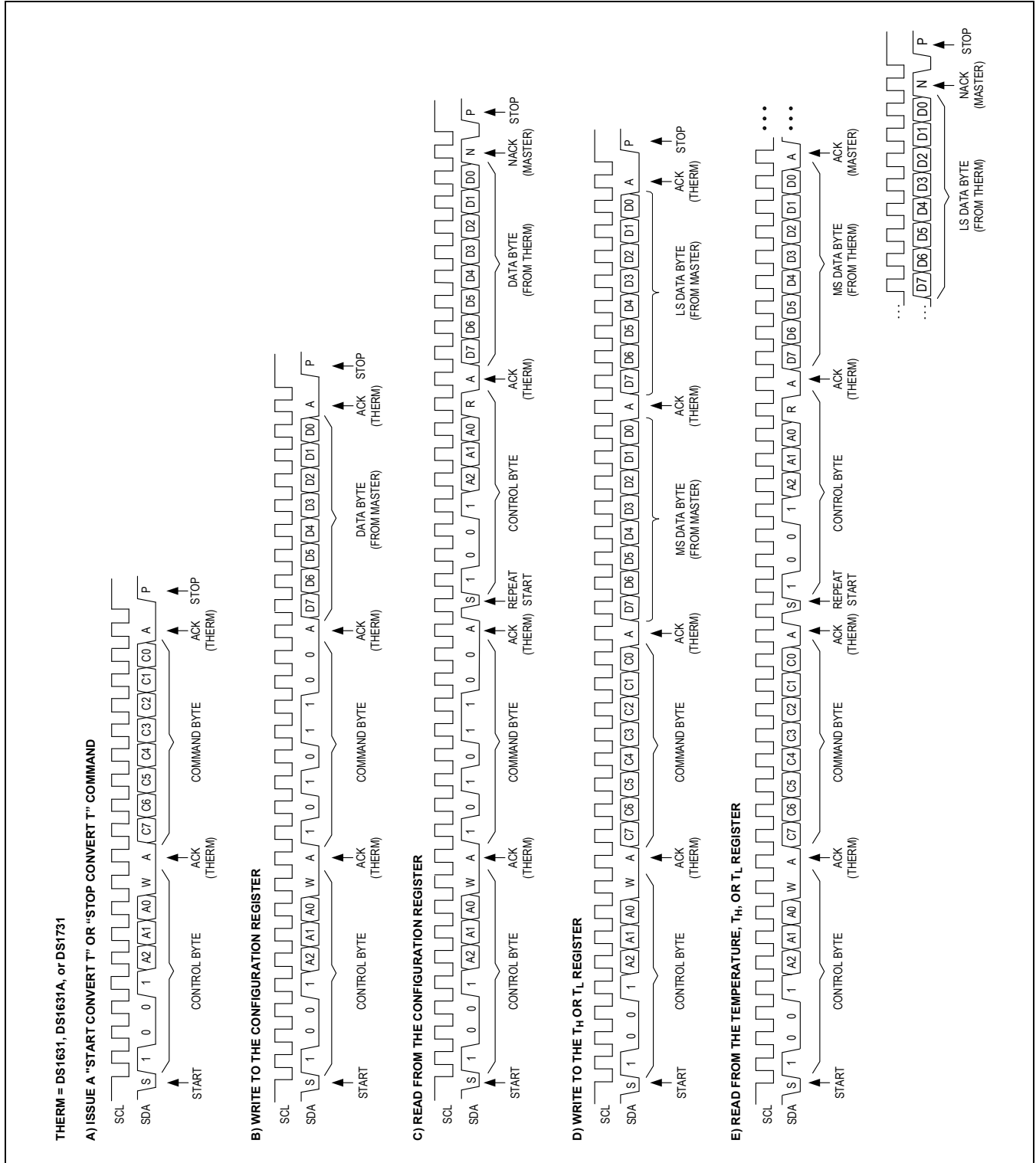

Figure 9. (a, b, c, d, e). 2-Wire Interface Timing

### Operation Example

In this example, the master configures the DS1631/DS1631A/DS1731 ( $A_1A_2A_3 = 000$ ) for continuous conversions and thermostatic function.

MASTER MODE	THERMETER* MODE	DATA (MSB FIRST)	COMMENTS
TX	RX	START	START condition from MASTER.
TX	RX	90h	MASTER sends control byte with $R/\overline{W} = 0$ .
RX	TX	ACK	Acknowledge bit from THERMOMETER.
TX	RX	ACh	MASTER sends Access Config command.
RX	TX	ACK	Acknowledge bit from THERMOMETER.
TX	RX	02h	MASTER writes a data byte to the configuration register to put the THERMOMETER in continuous conversion mode and set the $T_{OUT}$ polarity to active high.
RX	TX	ACK	Acknowledge bit from THERMOMETER.
TX	RX	STOP	STOP condition from MASTER.
TX	RX	START	START condition from MASTER.
TX	RX	90h	MASTER sends control byte with $R/\overline{W} = 0$ .
RX	TX	ACK	Acknowledge bit from THERMOMETER.
TX	RX	A1h	MASTER sends Access TH command.
RX	TX	ACK	Acknowledge bit from THERMOMETER.
TX	RX	28h	MASTER sends most significant data byte for $T_H = +40^\circ\text{C}$ .
RX	TX	ACK	Acknowledge bit from THERMOMETER.
TX	RX	00h	MASTER sends least significant data byte for $T_H = +40^\circ\text{C}$ .
RX	TX	ACK	Acknowledge bit from THERMOMETER.
TX	RX	STOP	STOP condition from MASTER.
TX	RX	START	START condition from MASTER.
TX	RX	90h	MASTER sends control byte with $R/\overline{W} = 0$ .
RX	TX	ACK	Acknowledge bit from THERMOMETER.
TX	RX	A2h	MASTER sends Access TL command.
RX	TX	ACK	Acknowledge bit from THERMOMETER.
TX	RX	0Ah	MASTER sends most significant data byte for $T_L = +10^\circ\text{C}$ .
RX	TX	ACK	Acknowledge bit from THERMOMETER.
TX	RX	00h	MASTER sends least significant data byte for $T_L = +10^\circ\text{C}$ .
RX	TX	ACK	Acknowledge bit from THERMOMETER.
TX	RX	STOP	STOP condition from MASTER.
TX	RX	START	START condition from MASTER.
TX	RX	90h	MASTER sends control byte with $R/\overline{W} = 0$ .
RX	TX	ACK	Acknowledge bit from THERMOMETER.
TX	RX	51h	MASTER sends Start Convert T command.
RX	TX	ACK	Acknowledge bit from THERMOMETER.
TX	RX	STOP	STOP condition from MASTER.

\*THERMOMETER = DS1631, DS1631A, or DS1731

**Table 1. Ordering Information**

ORDERING NUMBER	PACKAGE MARKING	DESCRIPTION
DS1631U+	D1631 (See Note)	DS1631 in Lead-Free 8-Pin $\mu$ SOP
DS1631U+T&R	D1631 (See Note)	DS1631 in Lead-Free 8-Pin $\mu$ SOP, 3000 Piece Tape-and-Reel
DS1631Z+	DS1631Z (See Note)	DS1631 in Lead-Free 150 mil 8-Pin SO
DS1631Z+T&R	DS1631Z (See Note)	DS1631 in Lead-Free 150 mil 8-Pin SO, 2500 Piece Tape-and-Reel
DS1631AU+	1631A (See Note)	DS1631A in Lead-Free 8-Pin $\mu$ SOP
DS1631AU+T&R	1631A (See Note)	DS1631A in Lead-Free 8-Pin $\mu$ SOP, 3000 Piece Tape-and-Reel
DS1631S+	DS1631S (See Note)	DS1631 in Lead-Free 208 mil 8-Pin SO
DS1631S+T&R	DS1631S (See Note)	DS1631 in Lead-Free 208 mil 8-Pin SO, 2000 Piece Tape-and-Reel
DS1631+	DS1631 (See Note)	DS1631 in Lead-Free 300 mil 8-Pin DIP
DS1731U+	D1731 (See Note)	DS1731 in Lead-Free 8-Pin $\mu$ SOP
DS1731U+T&R	D1731 (See Note)	DS1731 in Lead-Free 8-Pin $\mu$ SOP, 3000 Piece Tape-and-Reel
DS1631U	D1631	DS1631 in 8-Pin $\mu$ SOP
DS1631U/T&R	D1631	DS1631 in 8-Pin $\mu$ SOP, 3000-Piece Tape-and-Reel
DS1631Z	DS1631Z	DS1631 in 150mil 8-Pin SO
DS1631Z/T&R	DS1631Z	DS1631 in 150mil 8-Pin SO, 2500-Piece Tape-and-Reel
DS1631AU	1631A	DS1631A in 8-Pin $\mu$ SOP
DS1631AU/T&R	1631A	DS1631A in 8-Pin $\mu$ SOP, 3000-Piece Tape-and-Reel
DS1631S	DS1631S	DS1631 in 208 mil 8-Pin SO
DS1631S/T&R	DS1631S	DS1631 in Lead-Free 208 mil 8-Pin SO, 2000 Piece Tape-and-Reel
DS1631	DS1631	DS1631 in 300 mil 8-Pin DIP
DS1731U	D1731	DS1731 in 8-Pin $\mu$ SOP
DS1731U/T&R	D1731	DS1731 in 8-Pin $\mu$ SOP, 3000-Piece Tape-and-Reel

**Note:** A "+" symbol will also be marked on the package near the Pin 1 indicator.

## Revision History

REVISION NUMBER	REVISION DATE	DESCRIPTION	PAGES CHANGED
0	10/07	Initial release	—
1	1/15	Updated <i>Benefits and Features</i> section	1

For pricing, delivery, and ordering information, please contact Maxim Direct at 1-888-629-4642, or visit Maxim Integrated's website at [www.maximintegrated.com](http://www.maximintegrated.com).

*Maxim Integrated cannot assume responsibility for use of any circuitry other than circuitry entirely embodied in a Maxim Integrated product. No circuit patent licenses are implied. Maxim Integrated reserves the right to change the circuitry and specifications without notice at any time. The parametric values (min and max limits) shown in the Electrical Characteristics table are guaranteed. Other parametric values quoted in this data sheet are provided for guidance.*

## Looking for pricing, stock, or lifecycle information?

Click below to explore more details on WIN SOURCE:

 [View DS1631S+T&R on WIN SOURCE](#)

 [Maxim Integrated](#) Information

## Optimize Your Supply Chain with WIN SOURCE Solutions

-  Global Sourcing Solution
-  Obsolete Management
-  Cost Control Management
-  Shortage Management
-  Alternative Solution
-  Excess Inventory Management