



**THE DATASHEET OF  
CDRH4D28CLDNP-4R7PC**



# SMD Power Inductor CDRH4D28C/LD



## Description

- Ferrite drum core construction.
- Magnetically shielded.
- L × W × H: 5.1 × 5.1 × 3.0 mm Max.
- Product weight: 0.21g(Ref.)
- Moisture Sensitivity Level: 1
- RoHS compliance.

## Environmental Data

- Operating temperature range: -40°C ~ +105°C (including coil's self temperature rise)
- Storage temperature range: -40°C ~ +105°C
- Solder reflow temperature: 260 °C peak.

## Packaging

- Carrier tape and reel packaging
- 12.9" diameter reel
- 2000pcs per reel

## Applications

- Ideally used in Mobile phone, PDA, MP3, HDD, DSC/DVC, Note book PC, etc as DC-DC converter inductors.

## Dimension - [mm]

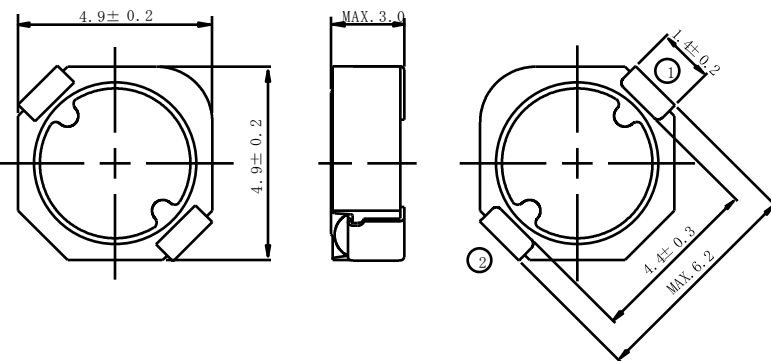

## Land pattern and Schematics - [mm]

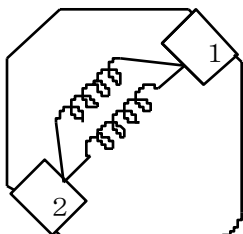
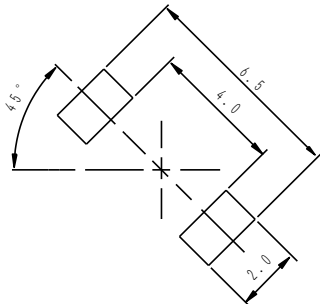

(1.0µH ~ 6.8µH)

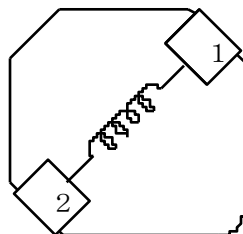

(10µH ~ 100µH)



### Electrical Characteristics

Part No.	Stamp	Inductance ( $\mu\text{H}$ ) [within] ※1	D.C.R (m $\Omega$ ) Max. (Typ.) (20°C)	Saturation Current (A) ※2	Temperature Rise Current (A) ※3
CDRH4D28CLDNP-1R0PC	A	1.0 $\pm$ 25%	17.5(14)	3.0	4.9
CDRH4D28CLDNP-2R2PC	B	2.2 $\pm$ 25%	23.8(19)	2.0	3.6
CDRH4D28CLDNP-3R3PC	C	3.3 $\pm$ 25%	28.9(23)	1.6	3.2
CDRH4D28CLDNP-4R7PC	D	4.7 $\pm$ 25%	36.3(29)	1.5	2.9
CDRH4D28CLDNP-6R8PC	E	6.8 $\pm$ 25%	48.8(39)	1.2	2.4
CDRH4D28CLDNP-100PC	F	10 $\pm$ 25%	67.5(54)	0.90	1.8
CDRH4D28CLDNP-150PC	G	15 $\pm$ 25%	93.4(75)	0.81	1.6
CDRH4D28CLDNP-220PC	H	22 $\pm$ 25%	140(112)	0.65	1.25
CDRH4D28CLDNP-330PC	I	33 $\pm$ 25%	223(179)	0.55	0.92
CDRH4D28CLDNP-470PC	J	47 $\pm$ 25%	272(218)	0.43	0.86
CDRH4D28CLDNP-680PC	K	68 $\pm$ 25%	366(293)	0.36	0.72
CDRH4D28CLDNP-101PC	L	100 $\pm$ 25%	520(416)	0.30	0.61

※1. Inductance measuring condition: at 100kHz.

※2. Saturation current: The value of D.C. current when the inductance decreases to 65% of it's nominal value.

※3. Temperature rise current: The value of D.C. current when the temperature rise is  $\Delta t = 40^\circ\text{C}$  ( $T_a = 20^\circ\text{C}$ ).

# SMD Power Inductor CDRH4D28C/LD



## Saturation Current & Temperature Rise Graph

— L (20°C) — L (100°C) —  $\Delta T$

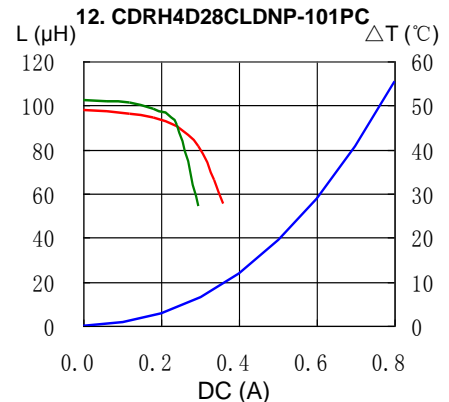
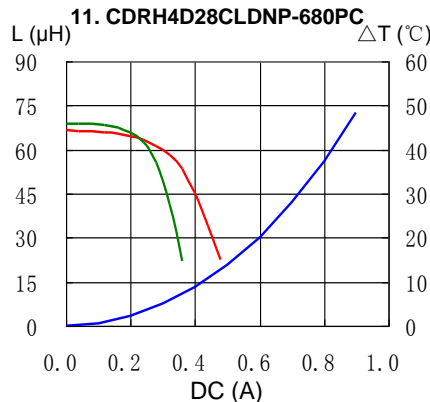
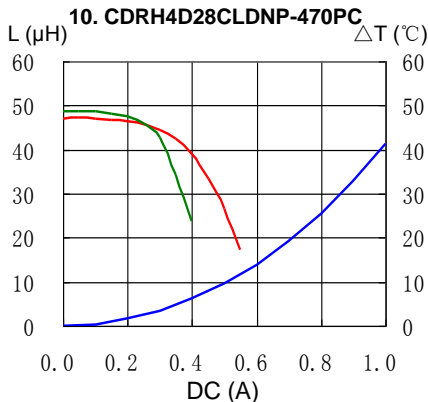
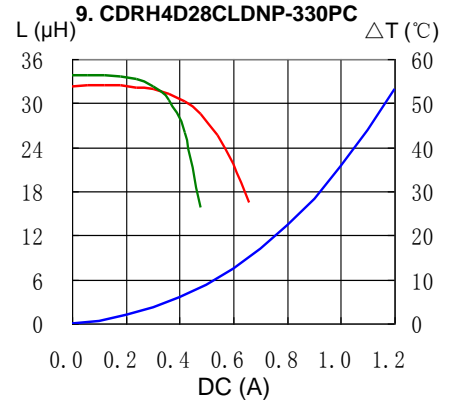
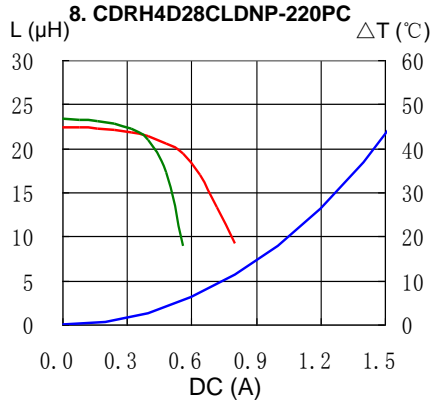
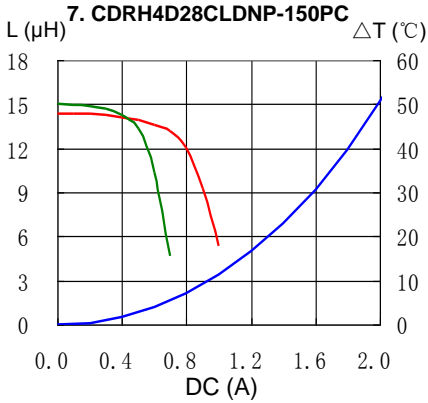
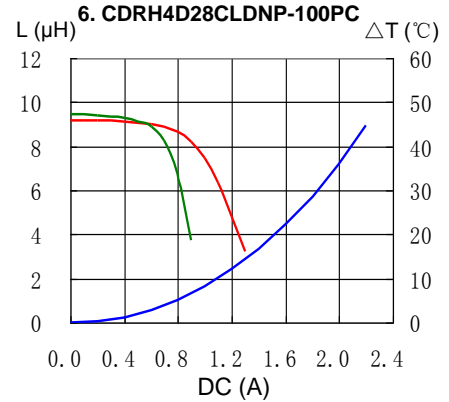
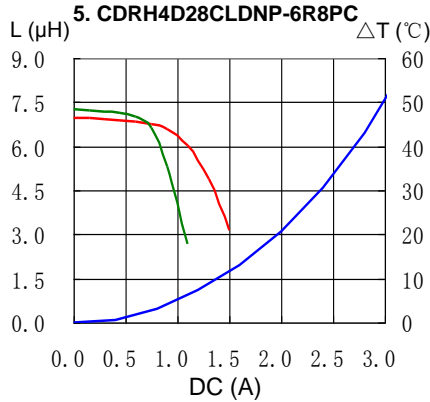
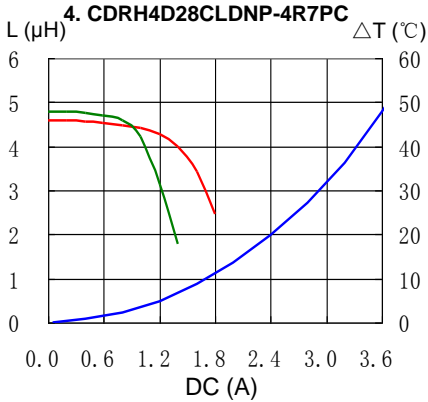
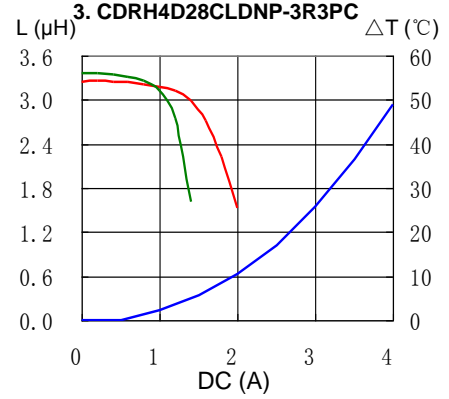
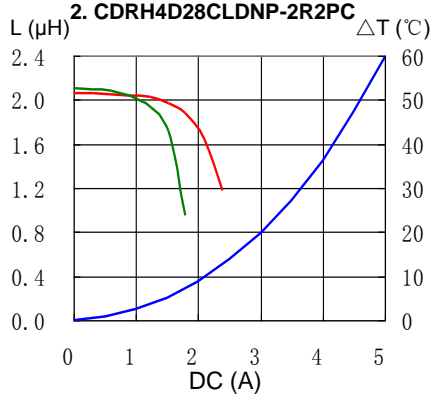
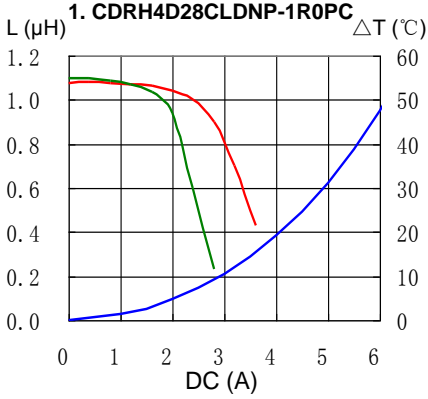

# SMD Power Inductor CDRH4D28C/LD



## Solder Reflow Condition

Heat Endurance

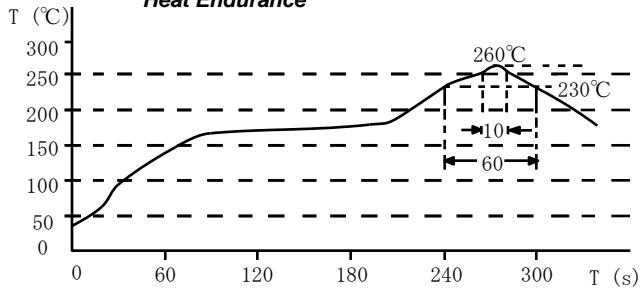

Temperature Chart

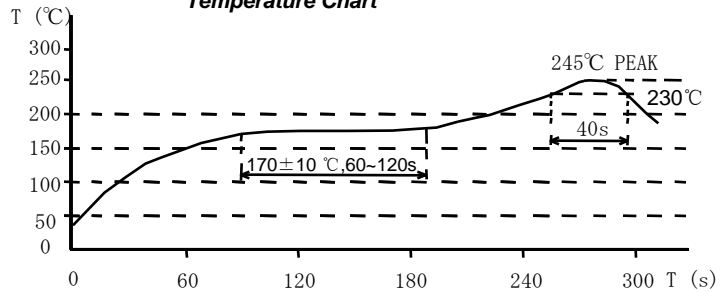

Please refer to the sales offices on our website - <http://www.sumida.com>

### Hong Kong

Tel.+852-2880-6781  
FAX.+852-2565-9600  
[sales@hk.sumida.com](mailto:sales@hk.sumida.com)

### Saitama(Japan)

Tel.+81-48-691-7300  
FAX.+81-48-691-7340  
[sales@jp.sumida.com](mailto:sales@jp.sumida.com)

### Chicago

Tel.+1-847-545-6700  
FAX. +1-847-545-6720  
[sales@us.sumida.com](mailto:sales@us.sumida.com)

### Shanghai

Tel.+86-21-5836-3299  
FAX.+86-21-5836-3266  
[shanghai.sales@cn.sumida.com](mailto:shanghai.sales@cn.sumida.com)

### Seoul

Tel.+82-2-6237-0777  
FAX.+82-2-6237-0778  
[sales@kr.sumida.com](mailto:sales@kr.sumida.com)

### Obernzell

Tel.+49-8591-937-0  
FAX. +49-8591-937-103  
[contact@eu.sumida.com](mailto:contact@eu.sumida.com)

### Shenzhen

Tel.+86-755-8291-0228  
FAX.+86-755-8291-0338  
[shenzhen.sales@cn.sumida.com](mailto:shenzhen.sales@cn.sumida.com)

### Singapore

Tel.+65-6296-3388  
FAX.+65-6841-4426  
[sales@sg.sumida.com](mailto:sales@sg.sumida.com)

### Neumarkt

Tel.+49-9181-4509-110  
FAX. +49-9181-4509-310  
[infocomp@eu.sumida.com](mailto:infocomp@eu.sumida.com)

### Taipei

Tel.+886-2-8751-2737  
FAX.+886-2-8751-2738  
[sales@tw.sumida.com](mailto:sales@tw.sumida.com)

### San Jose

Tel.+1-408-321-9660  
FAX.+1-408-321-9308  
[sales@us.sumida.com](mailto:sales@us.sumida.com)

## Looking for pricing, stock, or lifecycle information?

Click below to explore more details on WIN SOURCE:

- ⊖ [View CDRH4D28CLDNP-4R7PC on WIN SOURCE](#)
- ⊖ [Sumida America Components Inc. Information](#)

## Optimize Your Supply Chain with WIN SOURCE Solutions

- ✓ Global Sourcing Solution
- ✓ Obsolete Management
- ✓ Cost Control Management
- ✓ Shortage Management
- ✓ Alternative Solution
- ✓ Excess Inventory Management