



# THE DATASHEET OF TLV431BIPK



## TLV431x Low-Voltage Adjustable Precision Shunt Regulator

### 1 Features

- Low-Voltage Operation,  $V_{REF} = 1.24\text{ V}$
- Adjustable Output Voltage,  $V_O = V_{REF}$  to 6 V
- Reference Voltage Tolerances at 25°C
  - 0.5% for TLV431B
  - 1% for TLV431A
  - 1.5% for TLV431
- Typical Temperature Drift
  - 4 mV (0°C to 70°C)
  - 6 mV (–40°C to 85°C)
  - 11 mV (–40°C to 125°C)
- Low Operational Cathode Current, 80  $\mu\text{A}$  Typical
- 0.25- $\Omega$  Typical Output Impedance
- Ultra-Small SC-70 Package Offers 40% Smaller Footprint Than SOT-23-3
- See TLVH431 and TLVH432 for:
  - Wider  $V_{KA}$  (1.24 V to 18 V) and  $I_K$  (80 mA)
  - Additional SOT-89 Package
  - Multiple Pinouts for SOT-23-3 and SOT-89 Packages
- On Products Compliant to MIL-PRF-38535, All Parameters Are Tested Unless Otherwise Noted. On All Other Products, Production Processing Does Not Necessarily Include Testing of All Parameters.

### 2 Applications

- Adjustable Voltage and Current Referencing
- Secondary Side Regulation in Flyback SMPSs
- Zener Replacement
- Voltage Monitoring
- Comparator With Integrated Reference

### 3 Description

The TLV431 device is a low-voltage 3-terminal adjustable voltage reference with specified thermal stability over applicable industrial and commercial temperature ranges. Output voltage can be set to any value between  $V_{REF}$  (1.24 V) and 6 V with two external resistors (see the [Parameter Measurement Information](#) section). These devices operate from a lower voltage (1.24 V) than the widely used TL431 and TL1431 shunt-regulator references.

When used with an optocoupler, the TLV431 device is an ideal voltage reference in isolated feedback circuits for 3-V to 3.3-V switching-mode power supplies. These devices have a typical output impedance of 0.25  $\Omega$ . Active output circuitry provides a very sharp turnon characteristic, making them excellent replacements for low-voltage Zener diodes in many applications, including on-board regulation and adjustable power supplies.

#### Device Information<sup>(1)</sup>

PART NUMBER	PACKAGE (PIN)	BODY SIZE (NOM)
TLV431x	SOT-23 (3)	2.90 mm x 1.30 mm
	SOT-23 (5)	2.90 mm x 1.60 mm
	SC70 (6)	2.00 mm x 1.25 mm
	TO-92 (3)	4.30 mm x 4.30 mm
	SOIC (8)	4.90 mm x 3.90 mm

(1) For all available packages, see the orderable addendum at the end of the data sheet.

#### Simplified Schematic



## Table of Contents

<b>1 Features</b> .....	<b>1</b>	8.3 Feature Description .....	17
<b>2 Applications</b> .....	<b>1</b>	8.4 Device Functional Modes .....	18
<b>3 Description</b> .....	<b>1</b>	<b>9 Applications and Implementation</b> .....	<b>19</b>
<b>4 Revision History</b> .....	<b>2</b>	9.1 Application Information .....	19
<b>5 Pin Configuration and Functions</b> .....	<b>3</b>	9.2 Typical Applications .....	20
<b>6 Specifications</b> .....	<b>4</b>	<b>10 Power Supply Recommendations</b> .....	<b>24</b>
6.1 Absolute Maximum Ratings .....	4	<b>11 Layout</b> .....	24
6.2 ESD Ratings .....	4	11.1 Layout Guidelines .....	24
6.3 Recommended Operating Conditions .....	4	11.2 Layout Example .....	24
6.4 Thermal Information .....	4	<b>12 Device and Documentation Support</b> .....	<b>25</b>
6.5 Electrical Characteristics for TLV431 .....	5	12.1 Documentation Support .....	25
6.6 Electrical Characteristics for TLV431A .....	6	12.2 Related Links .....	25
6.7 Electrical Characteristics for TLV431B .....	7	12.3 Receiving Notification of Documentation Updates .....	25
6.8 Typical Characteristics .....	8	12.4 Community Resources .....	25
<b>7 Parameter Measurement Information</b> .....	<b>16</b>	12.5 Trademarks .....	25
<b>8 Detailed Description</b> .....	<b>17</b>	12.6 Electrostatic Discharge Caution .....	25
8.1 Overview .....	17	12.7 Glossary .....	25
8.2 Functional Block Diagram .....	17	<b>13 Mechanical, Packaging, and Orderable Information</b> .....	<b>25</b>

## 4 Revision History

### Changes from Revision W (March 2018) to Revision X Page

- Changed figure 18 .....

14

### Changes from Revision V (January 2015) to Revision W Page

- Changed crossreference link in the *Description* section .....
- Changed the *Stability Boundary Conditions* graph .....
- Added the *Phase Margin vs Capacitive Load  $V_{KA} = V_{REF} (1.25 V)$ ,  $T_A = 25^\circ\text{C}$*  graph .....
- Added the *Phase Margin vs Capacitive Load  $V_{KA} = 2.50 V$ ,  $T_A = 25^\circ\text{C}$*  graph .....
- Added the *Phase Margin vs Capacitive Load  $V_{KA} = 5.00 V$ ,  $T_A = 25^\circ\text{C}$*  graph .....
- Added *Documentation Support* section .....
- Added *Receiving Notification of Documentation Updates* section .....
- Added *Community Resources* section .....

1

13

14

14

15

25

25

25

### Changes from Revision U (January 2014) to Revision V Page

- Added *Applications*, *Device Information* table, *Pin Functions* table, *ESD Ratings* table, *Thermal Information* table, *Feature Description* section, *Device Functional Modes*, *Application and Implementation* section, *Power Supply Recommendations* section, *Layout* section, *Device and Documentation Support* section, and *Mechanical, Packaging, and Orderable Information* section. ....

1

### Changes from Revision T (June 2007) to Revision U Page

- Updated document to new TI data sheet format .....
- Deleted *Ordering Information* table. ....
- Updated *Features*. ....

1

1

1

## 5 Pin Configuration and Functions

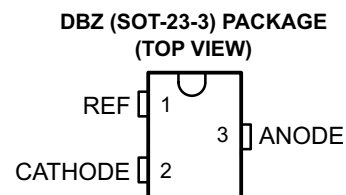
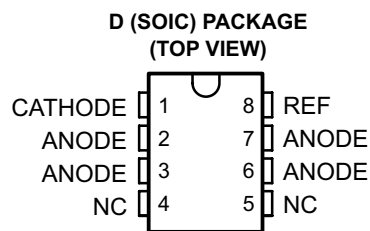

NC – No internal connection  
 \* For TLV431, TLV431A: NC – No internal connection  
 \* For TLV431B: Pin 2 is attached to Substrate and must be connected to ANODE or left open.

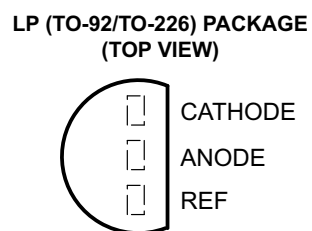
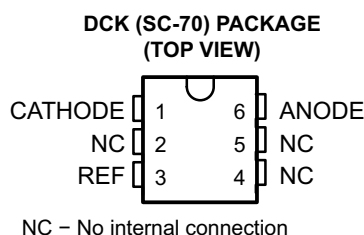
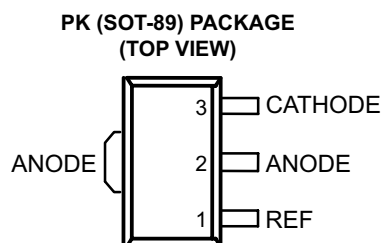

### Pin Functions

NAME	PIN						TYPE	DESCRIPTION
	DBZ	DBV	PK	D	LP	DCK		
CATHODE	2	3	3	1	1	1	I/O	Shunt Current/Voltage input
REF	1	4	1	8	3	3	I	Threshold relative to common anode
ANODE	3	5	2	2, 3, 6, 7	2	6	O	Common pin, normally connected to ground
NC	—	1	—	4, 5	—	2, 4, 5	I	No Internal Connection
*	—	2	—	—	—	—	I	Substrate Connection

## 6 Specifications

### 6.1 Absolute Maximum Ratings

over operating free-air temperature range (unless otherwise noted)<sup>(1)</sup>

		MIN	MAX	UNIT
$V_{KA}$	Cathode voltage <sup>(2)</sup>		7	V
$I_K$	Continuous cathode current	-20	20	mA
$I_{ref}$	Reference current	-0.05	3	mA
	Operating virtual junction temperature		150	°C
$T_{stg}$	Storage temperature	-65	150	°C

- (1) Stresses beyond those listed under *Absolute Maximum Ratings* may cause permanent damage to the device. These are stress ratings only, and functional operation of the device at these or any other conditions beyond those indicated under *Recommended Operating Conditions* is not implied. Exposure to absolute-maximum-rated conditions for extended periods may affect device reliability.
- (2) Voltage values are with respect to the anode terminal, unless otherwise noted.

### 6.2 ESD Ratings

PARAMETER	DEFINITION	VALUE	UNIT
$V_{(ESD)}$	Electrostatic discharge	Human body model (HBM), per ANSI/ESDA/JEDEC JS-001, all pins <sup>(1)</sup>	±2000
		Charged device model (CDM), per JEDEC specification JESD22-C101, all pins <sup>(2)</sup>	±1000

- (1) JEDEC document JEP155 states that 500-V HBM allows safe manufacturing with a standard ESD control process.
- (2) JEDEC document JEP157 states that 250-V CDM allows safe manufacturing with a standard ESD control process.

### 6.3 Recommended Operating Conditions

over operating free-air temperature range (unless otherwise noted)

		MIN	MAX	UNIT
$V_{KA}$	Cathode voltage	$V_{REF}$	6	V
$I_K$	Cathode current	0.1	15	mA
$T_A$	Operating free-air temperature	TLV431_C	0	70
		TLV431_I	-40	85
		TLV431_Q	-40	125

### 6.4 Thermal Information

THERMAL METRIC <sup>(1)</sup>	TLV431x						UNIT	
	DCK	D	PK	DBV	DBZ	LP		
	6 PINS	8 PINS	3 PINS	5 PINS	3 PINS	3 PINS		
$R_{\theta JA}$	Junction-to-ambient thermal resistance	87	97	52	206	206	140	°C/W
$R_{\theta JC(top)}$	Junction-to-case (top) thermal resistance	259	39	9	131	76	55	°C/W

- (1) For more information about traditional and new thermal metrics, see the *Semiconductor and IC Package Thermal Metrics* application report (SPRA953).

## 6.5 Electrical Characteristics for TLV431

at 25°C free-air temperature (unless otherwise noted)

PARAMETER	TEST CONDITIONS	TLV431			UNIT	
		MIN	TYP	MAX		
$V_{REF}$ Reference voltage	$V_{KA} = V_{REF}$ , $I_K = 10$ mA	$T_A = 25^\circ\text{C}$	1.222	1.24	1.258	V
		$T_A = \text{full range}^{(1)}$ (see Figure 22)	TLV431C	1.21	1.27	
	TLV431I		1.202	1.278		
	TLV431Q		1.194	1.286		
$V_{REF(dev)}$ $V_{REF}$ deviation over full temperature range <sup>(2)</sup>	$V_{KA} = V_{REF}$ , $I_K = 10$ mA <sup>(1)</sup> (see Figure 22)	TLV431C	4	12	mV	
		TLV431I	6	20		
		TLV431Q	11	31		
$\frac{\Delta V_{REF}}{\Delta V_{KA}}$ Ratio of $V_{REF}$ change in cathode voltage change	$V_{KA} = V_{REF}$ to 6 V, $I_K = 10$ mA (see Figure 23)		-1.5	-2.7	mV/V	
$I_{ref}$ Reference terminal current	$I_K = 10$ mA, $R1 = 10$ k $\Omega$ , $R2 = \text{open}$ (see Figure 23)		0.15	0.5	$\mu\text{A}$	
$I_{ref(dev)}$ $I_{ref}$ deviation over full temperature range <sup>(2)</sup>	$I_K = 10$ mA, $R1 = 10$ k $\Omega$ , $R2 = \text{open}^{(1)}$ (see Figure 23)	TLV431C	0.05	0.3	$\mu\text{A}$	
		TLV431I	0.1	0.4		
		TLV431Q	0.15	0.5		
$I_{K(min)}$ Minimum cathode current for regulation	$V_{KA} = V_{REF}$ (see Figure 22)	TLV431C/I	55	80	$\mu\text{A}$	
		TLV431Q	55	100		
$I_{K(off)}$ Off-state cathode current	$V_{REF} = 0$ , $V_{KA} = 6$ V (see Figure 24)		0.001	0.1	$\mu\text{A}$	
$ z_{KA} $ Dynamic impedance <sup>(3)</sup>	$V_{KA} = V_{REF}$ , $f \leq 1$ kHz, $I_K = 0.1$ mA to 15 mA (see Figure 22)		0.25	0.4	$\Omega$	

(1) Full temperature ranges are  $-40^\circ\text{C}$  to  $125^\circ\text{C}$  for TLV431Q,  $-40^\circ\text{C}$  to  $85^\circ\text{C}$  for TLV431I, and  $0^\circ\text{C}$  to  $70^\circ\text{C}$  for TLV431C.

(2) The deviation parameters  $V_{REF(dev)}$  and  $I_{ref(dev)}$  are defined as the differences between the maximum and minimum values obtained over the rated temperature range. The average full-range temperature coefficient of the reference input voltage,  $\alpha V_{REF}$ , is defined as:

$$|\alpha V_{REF}| \left( \frac{\text{ppm}}{^\circ\text{C}} \right) = \frac{\left( \frac{V_{REF(dev)}}{V_{REF}(T_A = 25^\circ\text{C})} \right) \times 10^6}{\Delta T_A}$$

where  $\Delta T_A$  is the rated operating free-air temperature range of the device.

 $\alpha V_{REF}$  can be positive or negative, depending on whether minimum  $V_{REF}$  or maximum  $V_{REF}$ , respectively, occurs at the lower temperature.

(3) The dynamic impedance is defined as  $|z_{ka}| = \frac{\Delta V_{KA}}{\Delta I_K}$ 

When the device is operating with two external resistors (see Figure 23), the total dynamic impedance of the circuit is defined as:

$$|z_{ka}|' = \frac{\Delta V}{\Delta I} \approx |z_{ka}| \times \left( 1 + \frac{R1}{R2} \right)$$

## 6.6 Electrical Characteristics for TLV431A

at 25°C free-air temperature (unless otherwise noted)

PARAMETER	TEST CONDITIONS		TLV431A			UNIT
			MIN	TYP	MAX	
$V_{REF}$ Reference voltage	$V_{KA} = V_{REF}$ , $I_K = 10\text{ mA}$	$T_A = 25^\circ\text{C}$	1.228	1.24	1.252	V
		$T_A = \text{full range}^{(1)}$ (see Figure 22)	TLV431AC	1.221	1.259	
			TLV431AI	1.215	1.265	
			TLV431AQ	1.209	1.271	
$V_{REF(\text{dev})}$ $V_{REF}$ deviation over full temperature range <sup>(2)</sup>	$V_{KA} = V_{REF}$ , $I_K = 10\text{ mA}^{(1)}$ (see Figure 22)	TLV431AC		4	12	mV
		TLV431AI		6	20	
		TLV431AQ		11	31	
$\frac{\Delta V_{REF}}{\Delta V_{KA}}$ Ratio of $V_{REF}$ change in cathode voltage change	$V_{KA} = V_{REF}$ to 6 V, $I_K = 10\text{ mA}$ (see Figure 23)		-1.5	-2.7	mV/V	
$I_{ref}$ Reference terminal current	$I_K = 10\text{ mA}$ , $R1 = 10\text{ k}\Omega$ , $R2 = \text{open}$ (see Figure 23)		0.15	0.5	$\mu\text{A}$	
$I_{ref(\text{dev})}$ $I_{ref}$ deviation over full temperature range <sup>(2)</sup>	$I_K = 10\text{ mA}$ , $R1 = 10\text{ k}\Omega$ , $R2 = \text{open}^{(1)}$ (see Figure 23)	TLV431AC		0.05	0.3	$\mu\text{A}$
		TLV431AI		0.1	0.4	
		TLV431AQ		0.15	0.5	
$I_{K(\text{min})}$ Minimum cathode current for regulation	$V_{KA} = V_{REF}$ (see Figure 22)	TLV431AC/AI		55	80	$\mu\text{A}$
		TLV431AQ		55	100	
$I_{K(\text{off})}$ Off-state cathode current	$V_{REF} = 0$ , $V_{KA} = 6\text{ V}$ (see Figure 24)		0.001	0.1	$\mu\text{A}$	
$ z_{KA} $ Dynamic impedance <sup>(3)</sup>	$V_{KA} = V_{REF}$ , $f \leq 1\text{ kHz}$ , $I_K = 0.1\text{ mA}$ to 15 mA (see Figure 22)		0.25	0.4	$\Omega$	

(1) Full temperature ranges are  $-40^\circ\text{C}$  to  $125^\circ\text{C}$  for TLV431Q,  $-40^\circ\text{C}$  to  $85^\circ\text{C}$  for TLV431I, and  $0^\circ\text{C}$  to  $70^\circ\text{C}$  for TLV431C.

(2) The deviation parameters  $V_{REF(\text{dev})}$  and  $I_{ref(\text{dev})}$  are defined as the differences between the maximum and minimum values obtained over the rated temperature range. The average full-range temperature coefficient of the reference input voltage,  $\alpha V_{REF}$ , is defined as:

$$|\alpha V_{REF}| \left( \frac{\text{ppm}}{^\circ\text{C}} \right) = \frac{\left( \frac{V_{REF(\text{dev})}}{V_{REF}(T_A = 25^\circ\text{C})} \right) \times 10^6}{\Delta T_A}$$

where  $\Delta T_A$  is the rated operating free-air temperature range of the device.

$\alpha V_{REF}$  can be positive or negative, depending on whether minimum  $V_{REF}$  or maximum  $V_{REF}$ , respectively, occurs at the lower temperature.

(3) The dynamic impedance is defined as  $|z_{ka}| = \frac{\Delta V_{KA}}{\Delta I_K}$

When the device is operating with two external resistors (see Figure 23), the total dynamic impedance of the circuit is defined as:

$$|z_{ka}|' = \frac{\Delta V}{\Delta I} \approx |z_{ka}| \times \left( 1 + \frac{R1}{R2} \right)$$

## 6.7 Electrical Characteristics for TLV431B

at 25°C free-air temperature (unless otherwise noted)

PARAMETER	TEST CONDITIONS	TLV431B			UNIT	
		MIN	TYP	MAX		
$V_{REF}$ Reference voltage	$V_{KA} = V_{REF}$ , $I_K = 10$ mA	$T_A = 25^\circ\text{C}$	1.234	1.24	1.246	V
		$T_A = \text{full range}^{(1)}$ (see Figure 22)	TLV431BC	1.227	1.253	
			TLV431BI	1.224	1.259	
			TLV431BQ	1.221	1.265	
$V_{REF(\text{dev})}$ $V_{REF}$ deviation over full temperature range <sup>(2)</sup>	$V_{KA} = V_{REF}$ , $I_K = 10$ mA <sup>(1)</sup> (see Figure 22)	TLV431BC	4	12	mV	
		TLV431BI	6	20		
		TLV431BQ	11	31		
$\frac{\Delta V_{REF}}{\Delta V_{KA}}$ Ratio of $V_{REF}$ change in cathode voltage change	$V_{KA} = V_{REF}$ to 6 V, $I_K = 10$ mA (see Figure 23)		-1.5	-2.7	mV/V	
$I_{ref}$ Reference terminal current	$I_K = 10$ mA, $R1 = 10$ k $\Omega$ , $R2 = \text{open}$ (see Figure 23)		0.1	0.5	$\mu\text{A}$	
$I_{ref(\text{dev})}$ $I_{ref}$ deviation over full temperature range <sup>(2)</sup>	$I_K = 10$ mA, $R1 = 10$ k $\Omega$ , $R2 = \text{open}^{(3)}$ (see Figure 23)	TLV431BC	0.05	0.3	$\mu\text{A}$	
		TLV431BI	0.1	0.4		
		TLV431BQ	0.15	0.5		
$I_{K(\text{min})}$ Minimum cathode current for regulation	$V_{KA} = V_{REF}$ (see Figure 22)		55	100	$\mu\text{A}$	
$I_{K(\text{off})}$ Off-state cathode current	$V_{REF} = 0$ , $V_{KA} = 6$ V (see Figure 24)		0.001	0.1	$\mu\text{A}$	
$ z_{KA} $ Dynamic impedance <sup>(4)</sup>	$V_{KA} = V_{REF}$ , $f \leq 1$ kHz, $I_K = 0.1$ mA to 15 mA (see Figure 22)		0.25	0.4	$\Omega$	

(1) Full temperature ranges are  $-40^\circ\text{C}$  to  $125^\circ\text{C}$  for TLV431Q,  $-40^\circ\text{C}$  to  $85^\circ\text{C}$  for TLV431I, and  $0^\circ\text{C}$  to  $70^\circ\text{C}$  for TLV431C.

(2) The deviation parameters  $V_{REF(\text{dev})}$  and  $I_{ref(\text{dev})}$  are defined as the differences between the maximum and minimum values obtained over the rated temperature range. The average full-range temperature coefficient of the reference input voltage,  $\alpha V_{REF}$ , is defined as:

$$|\alpha V_{REF}| \left( \frac{\text{ppm}}{^\circ\text{C}} \right) = \frac{\left( \frac{V_{REF(\text{dev})}}{V_{REF}(T_A = 25^\circ\text{C})} \right) \times 10^6}{\Delta T_A}$$

where  $\Delta T_A$  is the rated operating free-air temperature range of the device.

 $\alpha V_{REF}$  can be positive or negative, depending on whether minimum  $V_{REF}$  or maximum  $V_{REF}$ , respectively, occurs at the lower temperature.

(3) Full temperature ranges are  $-40^\circ\text{C}$  to  $125^\circ\text{C}$  for TLV431Q,  $-40^\circ\text{C}$  to  $85^\circ\text{C}$  for TLV431I, and  $0^\circ\text{C}$  to  $70^\circ\text{C}$  for TLV431C.

(4) The dynamic impedance is defined as  $|z_{ka}| = \frac{\Delta V_{KA}}{\Delta I_K}$ 

When the device is operating with two external resistors (see Figure 23), the total dynamic impedance of the circuit is defined as:

$$|z_{ka}'| = \frac{\Delta V}{\Delta I} \approx |z_{ka}| \times \left( 1 + \frac{R1}{R2} \right)$$

### 6.8 Typical Characteristics

Operation of the device at these or any other conditions beyond those indicated in the *Recommended Operating Conditions* table are not implied.



Figure 1. Reference Voltage vs Junction Temperature



Figure 2. Reference Input Current vs Junction Temperature (for TLV431 and TLV431A)



Figure 3. Reference Input Current vs Junction Temperature (for TLV431B)



Figure 4. Cathode Current vs Cathode Voltage



Figure 5. Minimum Cathode Current vs Temperature



Figure 6. Cathode Current vs Cathode Voltage

### Typical Characteristics (continued)

Operation of the device at these or any other conditions beyond those indicated in the *Recommended Operating Conditions* table are not implied.

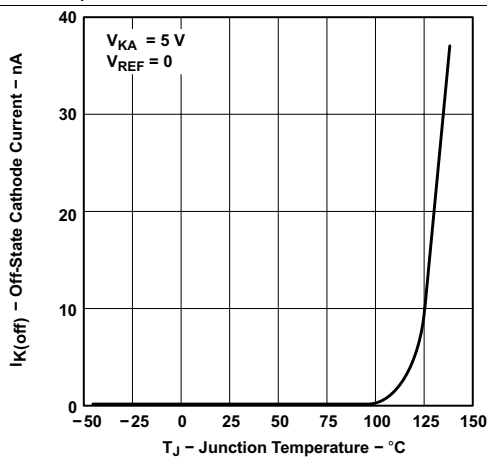

Figure 7. Off-State Cathode Current vs Junction Temperature (for TLV431 and TLV431A)

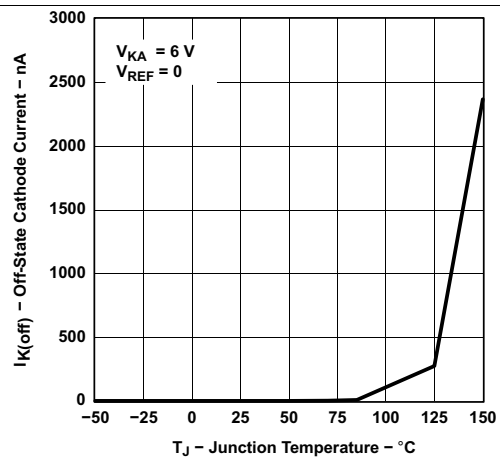

Figure 8. Off-State Cathode Current vs Junction Temperature (for TLV431B)

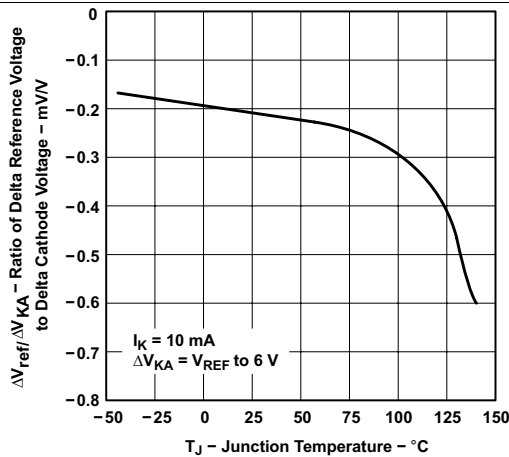

Figure 9. Ratio of Delta Reference Voltage to Delta Cathode Voltage vs Junction Temperature (for TLV431 and TLV431A)

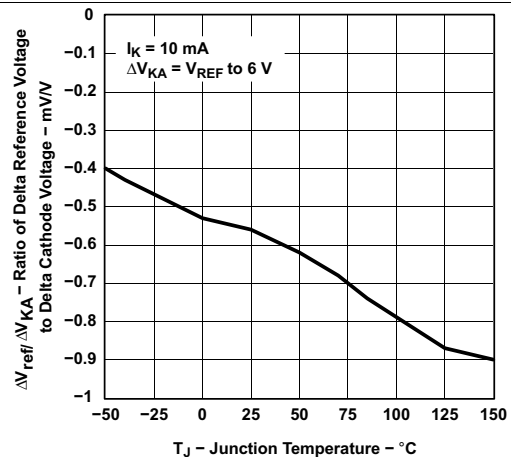

Figure 10. Ratio of Delta Reference Voltage to Delta Cathode Voltage vs Junction Temperature (for TLV431B)

Typical Characteristics (continued)

Operation of the device at these or any other conditions beyond those indicated in the *Recommended Operating Conditions* table are not implied.



‡ Extrapolated from life-test data taken at 125°C; the activation energy assumed is 0.7 eV.

Figure 11. Percentage Change in  $V_{REF}$  vs Operating Life at 55°C

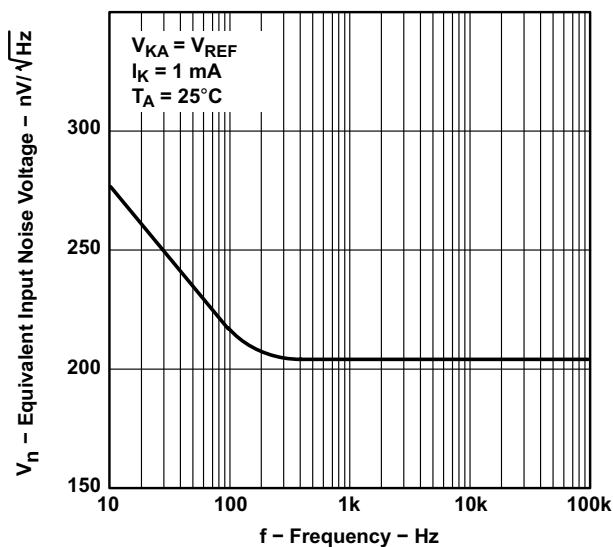

TEST CIRCUIT FOR EQUIVALENT INPUT NOISE VOLTAGE

Figure 12. Equivalent Input Noise Voltage

### Typical Characteristics (continued)

Operation of the device at these or any other conditions beyond those indicated in the *Recommended Operating Conditions* table are not implied.



Typical Characteristics (continued)

Operation of the device at these or any other conditions beyond those indicated in the *Recommended Operating Conditions* table are not implied.



Figure 14. Voltage Gain and Phase Margin



Figure 15. Reference Impedance vs Frequency

### Typical Characteristics (continued)

Operation of the device at these or any other conditions beyond those indicated in the *Recommended Operating Conditions* table are not implied.



### Typical Characteristics (continued)

Operation of the device at these or any other conditions beyond those indicated in the [Recommended Operating Conditions](#) table are not implied.

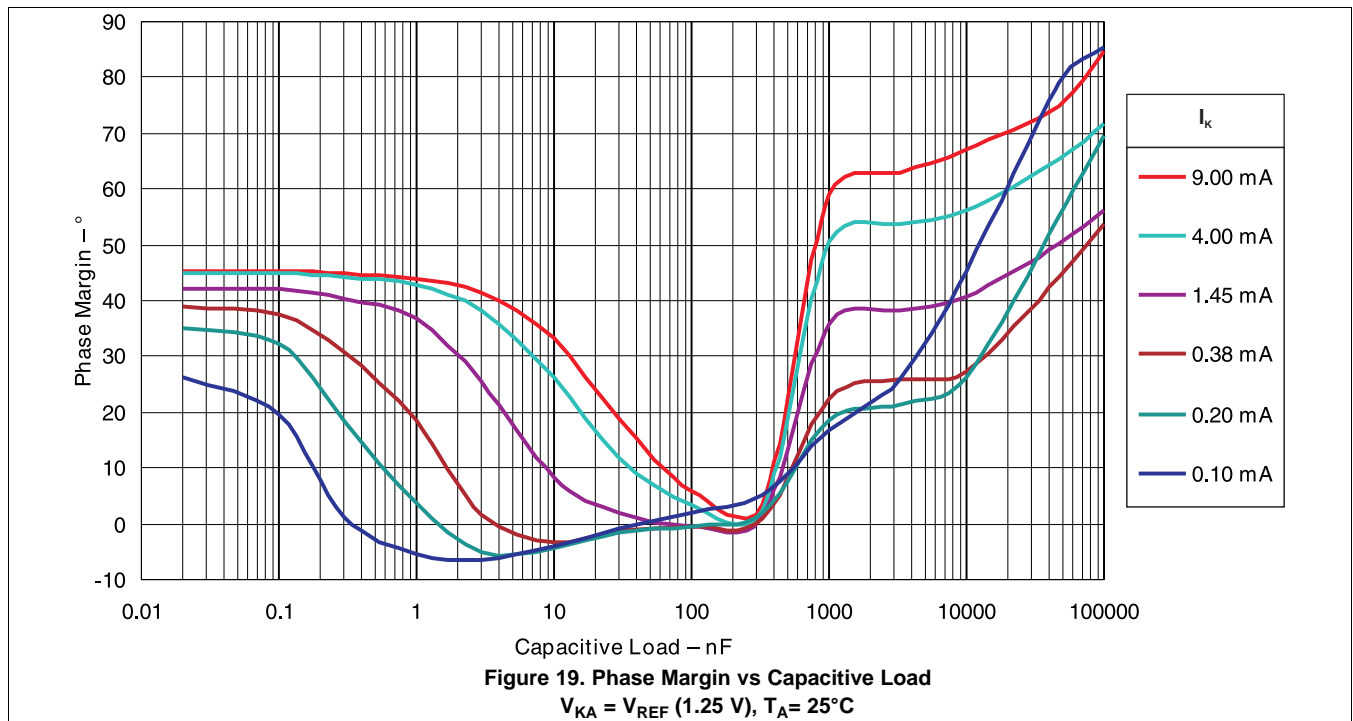

Typical Characteristics (continued)

Operation of the device at these or any other conditions beyond those indicated in the *Recommended Operating Conditions* table are not implied.

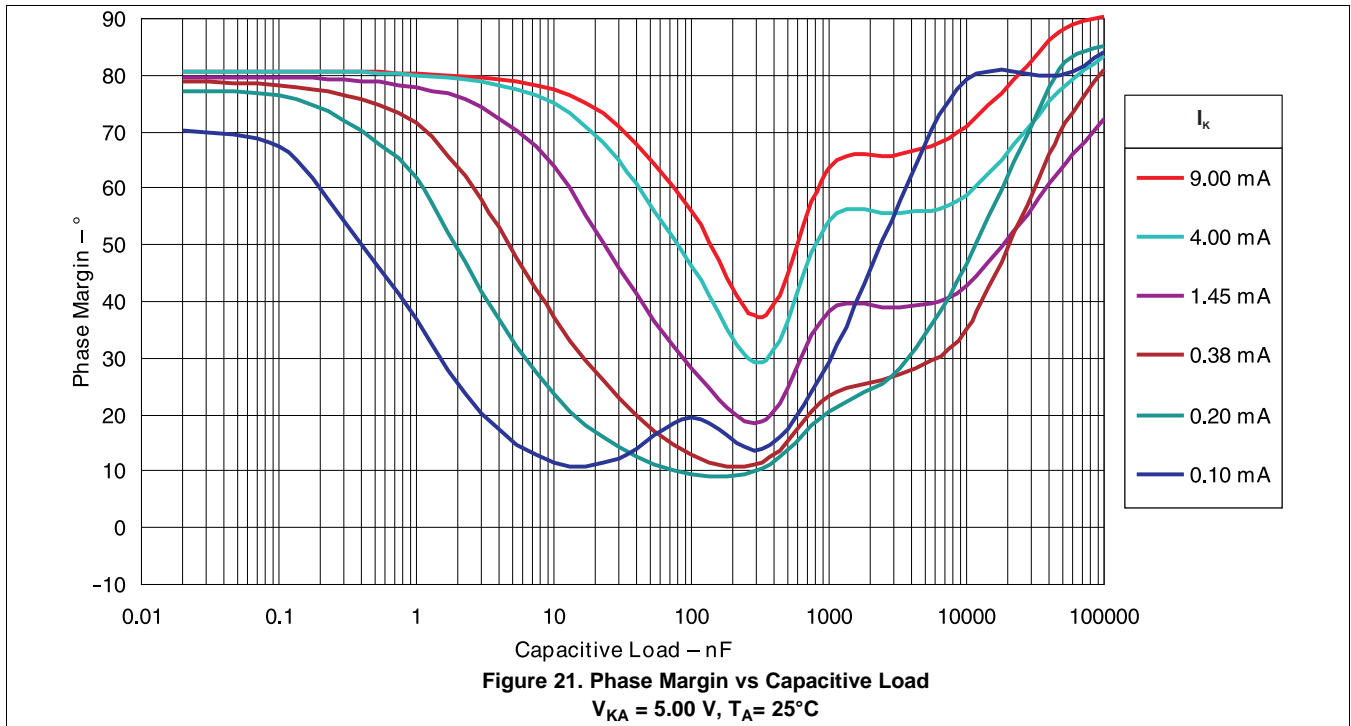

## 7 Parameter Measurement Information



Figure 22. Test Circuit for  $V_{KA} = V_{REF}$ ,  $V_O = V_{KA} = V_{REF}$



Figure 23. Test Circuit for  $V_{KA} > V_{REF}$ ,  $V_O = V_{KA} = V_{REF} \times (1 + R1/R2) + I_{ref} \times R1$



Figure 24. Test Circuit for  $I_{K(off)}$

## 8 Detailed Description

### 8.1 Overview

TLV431 is a low power counterpart to TL431, having lower reference voltage (1.24 V vs 2.5 V) for lower voltage adjustability and lower minimum cathode current ( $I_{k(\min)} = 100 \mu\text{A}$  vs 1 mA). Like TL431, TLV431 is used in conjunction with its key components to behave as a single voltage reference, error amplifier, voltage clamp, or comparator with integrated reference.

TLV431 can be operated and adjusted to cathode voltages from 1.24 V to 6 V, making this part optimum for a wide range of end equipments in industrial, auto, telecom, and computing. For this device to behave as a shunt regulator or error amplifier,  $> 100 \mu\text{A}$  ( $I_{\min(\max)}$ ) must be supplied in to the cathode pin. Under this condition, feedback can be applied from the Cathode and Ref pins to create a replica of the internal reference voltage.

Various reference voltage options can be purchased with initial tolerances (at 25°C) of 0.5%, 1%, and 1.5%. These reference options are denoted by B (0.5%), A (1.0%), and blank (1.5%) after the TLV431.

The TLV431xC devices are characterized for operation from 0°C to 70°C, the TLV431xI devices are characterized for operation from -40°C to 85°C, and the TLV431xQ devices are characterized for operation from -40°C to 125°C.

### 8.2 Functional Block Diagram



### 8.3 Feature Description

TLV431 consists of an internal reference and amplifier that outputs a sink current based on the difference between the reference pin and the virtual internal pin. The sink current is produced by an internal darlington pair.

When operated with enough voltage headroom ( $\geq 1.24 \text{ V}$ ) and cathode current ( $I_{ka}$ ), TLV431 forces the reference pin to 1.24 V. However, the reference pin can not be left floating, as it requires  $I_{ref} \geq 0.5 \mu\text{A}$  (see the [Functional Block Diagram](#)). This is because the reference pin is driven into an npn, which requires a base current to operate properly.

When feedback is applied from the Cathode and Reference pins, TLV431 behaves as a Zener diode, regulating to a constant voltage dependent on current being supplied into the cathode. This is due to the internal amplifier and reference entering the proper operating regions. The same amount of current required in the above feedback situation must be applied to this device in open-loop, servo, or error-amplifying implementations for it to be in the proper linear region giving TLV431 enough gain.

Unlike many linear regulators, TLV431 is internally compensated to be stable without an output capacitor between the cathode and anode. However, if it is desired to use an output capacitor [Figure 18](#) can be used as a guide to assist in choosing the correct capacitor to maintain stability.

## 8.4 Device Functional Modes

### 8.4.1 Open Loop (Comparator)

When the cathode/output voltage or current of TLV431 is not being fed back to the reference/input pin in any form, this device is operating in open loop. With proper cathode current ( $I_{ka}$ ) applied to this device, TLV431 will have the characteristics shown in [Figure 6](#). With such high gain in this configuration, TLV431 is typically used as a comparator. With the reference integrated makes TLV431 the preferred choice when users are trying to monitor a certain level of a single signal.

### 8.4.2 Closed Loop

When the cathode/output voltage or current of TLV431 is being fed back to the reference/input pin in any form, this device is operating in closed loop. The majority of applications involving TLV431 use it in this manner to regulate a fixed voltage or current. The feedback enables this device to behave as an error amplifier, computing a portion of the output voltage and adjusting it to maintain the desired regulation. This is done by relating the output voltage back to the reference pin in a manner to make it equal to the internal reference voltage, which can be accomplished through resistive or direct feedback.



## 9.2 Typical Applications

### 9.2.1 Comparator With Integrated Reference (Open Loop)



**Figure 26. Comparator Application Schematic**

#### 9.2.1.1 Design Requirements

For this design example, use the parameters listed in [Table 1](#) as the input parameters.

**Table 1. Design Parameters**

DESIGN PARAMETER	EXAMPLE VALUE
Input Voltage Range	0 V to 5 V
Input Resistance	10 k $\Omega$
Supply Voltage	5 V
Cathode Current ( $I_k$ )	500 $\mu$ A
Output Voltage Level	$\sim 1$ V - $V_{sup}$
Logic Input Thresholds $V_{IH}/V_{IL}$	$V_L$

#### 9.2.1.2 Detailed Design Procedure

When using TLV431 as a comparator with reference, determine the following:

- Input voltage range
- Reference voltage accuracy
- Output logic input high and low level thresholds
- Current source resistance

##### 9.2.1.2.1 Basic Operation

In the configuration shown in [Figure 26](#) TLV431 will behave as a comparator, comparing the  $V_{ref}$  pin voltage to the internal virtual reference voltage. When provided a proper cathode current ( $I_k$ ), TLV431 will have enough open-loop gain to provide a quick response. With the TLV431's maximum operating current ( $I_{min(max)}$ ) being 100  $\mu$ A and up to 150  $\mu$ A over temperature, operation below that could result in low gain, leading to a slow response.

**9.2.1.2.2 Overdrive**

Slow or inaccurate responses can also occur when the reference pin is not provided enough overdrive voltage. This is the amount of voltage that is higher than the internal virtual reference. The internal virtual reference voltage will be within the range of 1.24 V  $\pm$ (0.5%, 1.0%, or 1.5%) depending on which version is being used.

The more overdrive voltage provided, the faster the TLV431 will respond. This can be seen in [Figure 27](#) and [Figure 28](#) where it displays the output responses to various input voltages.

For applications where TLV431 is being used as a comparator, it is best to set the trip point to greater than the positive expected error (that is, +1.0% for the A version). For fast response, setting the trip point to > 10% of the internal  $V_{ref}$  should suffice.

For minimal voltage drop or difference from  $V_{in}$  to the ref pin, TI recommends using an input resistor < 10 k $\Omega$  to provide  $I_{ref}$ .

**9.2.1.2.3 Output Voltage and Logic Input Level**

In order for TLV431 to properly be used as a comparator, the logic output must be readable by the receiving logic device. This is accomplished by knowing the input high and low level threshold voltage levels, typically denoted by  $V_{IH}$  and  $V_{IL}$ .

As seen in [Figure 27](#), TLV431's output low level voltage in open-loop/comparator mode is approximately 1 V, which is sufficient for some 3.3-V supplied logic. However, this would not work for 2.5-V or 1.8-V supplied logic. To accommodate this a resistive divider can be tied to the output to attenuate the output voltage to a voltage legible to the receiving low voltage logic device.

TLV431's output high voltage is approximately  $V_{sup}$  due to TLV431 being open-collector. If  $V_{sup}$  is much higher than the receiving logic's maximum input voltage tolerance, the output must be attenuated to accommodate the outgoing logic's reliability.

When using a resistive divider on the output, be sure to make the sum of the resistive divider ( $R_1$  and  $R_2$  in [Figure 26](#)) is much greater than  $R_{sup}$  in order to not interfere with TLV431's ability to pull close to  $V_{sup}$  when turning off.

**9.2.1.2.3.1 Input Resistance**

TLV431 requires an input resistance in this application to source the reference current ( $I_{ref}$ ) needed from this device to be in the proper operating regions while turning on. The actual voltage seen at the ref pin will be  $V_{ref} = V_{in} - I_{ref} \times R_{in}$ . Because the  $I_{ref}$  can be as high as 0.5  $\mu$ A, TI recommends using a resistance small enough that will mitigate the error that  $I_{ref}$  creates from  $V_{in}$ .

**9.2.1.3 Application Curves**

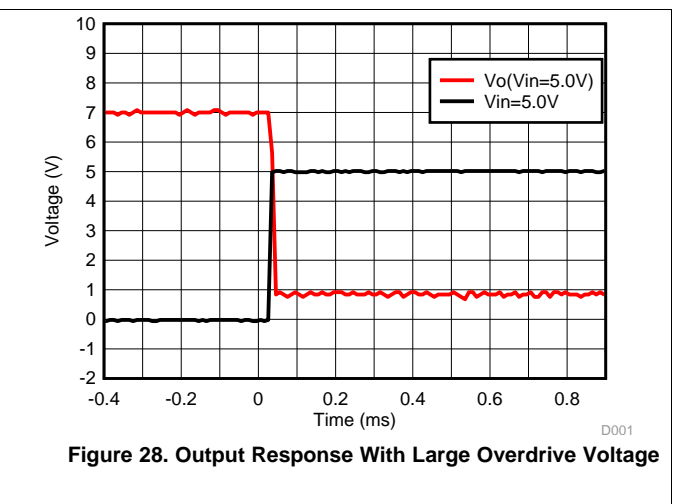

## 9.2.2 Shunt Regulator/Reference



**Figure 29. Shunt Regulator Schematic**

### 9.2.2.1 Design Requirements

For this design example, use the parameters listed in [Table 2](#) as the input parameters.

**Table 2. Design Parameters**

DESIGN PARAMETER	EXAMPLE VALUE
Reference Initial Accuracy	1.0%
Supply Voltage	6 V
Cathode Current (I <sub>k</sub> )	1 mA
Output Voltage Level	1.24 V - 6 V
Load Capacitance	100 nF
Feedback Resistor Values and Accuracy (R1 and R2)	10 kΩ

### 9.2.2.2 Detailed Design Procedure

When using TLV431 as a Shunt Regulator, determine the following:

- Input voltage range
- Temperature range
- Total accuracy
- Cathode current
- Reference initial accuracy
- Output capacitance

#### 9.2.2.2.1 Programming Output/Cathode Voltage

To program the cathode voltage to a regulated voltage a resistive bridge must be shunted between the cathode and anode pins with the mid point tied to the reference pin. This can be seen in [Figure 29](#), with R1 and R2 being the resistive bridge. The cathode/output voltage in the shunt regulator configuration can be approximated by the equation shown in [Figure 29](#). The cathode voltage can be more accurately determined by taking the cathode current in to account

$$V_O = (1 + R1 / R2) \times V_{ref} - I_{ref} \times R1 \quad (1)$$

For [Equation 1](#) to be valid, TLV431 must be fully biased so that it has enough open-loop gain to mitigate any gain error. This can be done by meeting the I<sub>min</sub> spec denoted in [Recommended Operating Conditions](#) table.

### 9.2.2.2.2 Total Accuracy

When programming the output above unity gain ( $V_{ka} = V_{ref}$ ), TLV431 is susceptible to other errors that may effect the overall accuracy beyond  $V_{ref}$ . These errors include:

- R1 and R2 accuracies
- $V_{I(dev)}$  – Change in reference voltage over temperature
- $\Delta V_{ref} / \Delta V_{KA}$  – Change in reference voltage to the change in cathode voltage
- $|z_{KA}|$  – Dynamic impedance, causing a change in cathode voltage with cathode current

Worst-case cathode voltage can be determined taking all of the variables in to account. Application note [Setting the Shunt Voltage on an Adjustable Shunt Regulator](#) (SLVA445) assists designers in setting the shunt voltage to achieve optimum accuracy for this device.

### 9.2.2.2.3 Stability

Though TLV431 is stable with no capacitive load, the device that receives the shunt regulator's output voltage could present a capacitive load that is within the TLV431 region of stability, shown in [Figure 18](#). Also, designers may use capacitive loads to improve the transient response or for power supply decoupling.

### 9.2.2.3 Application Curve

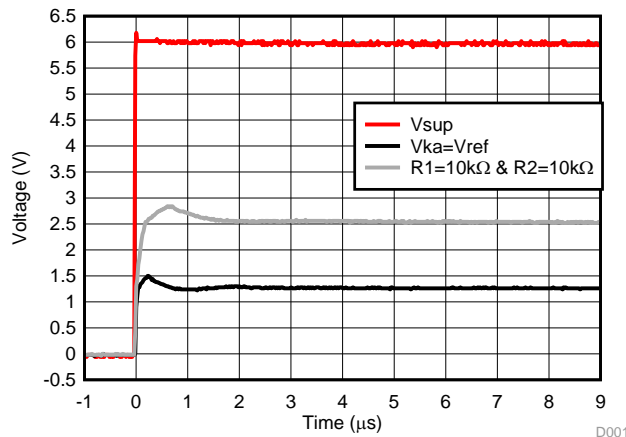

**Figure 30. TLV431 Start-Up Response**

## 10 Power Supply Recommendations

When using TLV431 as a Linear Regulator to supply a load, designers will typically use a bypass capacitor on the output/cathode pin. When doing this, be sure that the capacitance is within the stability criteria shown in [Figure 18](#).

To not exceed the maximum cathode current, be sure that the supply voltage is current limited. Also, be sure to limit the current being driven into the Ref pin, as not to exceed the absolute maximum rating.

For applications shunting high currents, pay attention to the cathode and anode trace lengths, adjusting the width of the traces to have the proper current density.

## 11 Layout

### 11.1 Layout Guidelines

Place decoupling capacitors as close to the device as possible. Use appropriate widths for traces when shunting high currents to avoid excessive voltage drops.

### 11.2 Layout Example



**Figure 31. DBZ Layout Example**

## 12 Device and Documentation Support

### 12.1 Documentation Support

#### 12.1.1 Related Documentation

For related documentation, see the following:

- [Compensation Design With TL431 for UCC28600](#) (SLUA671)
- [Setting the Shunt Voltage on an Adjustable Shunt Regulator](#) (SLVA445)

### 12.2 Related Links

The table below lists quick access links. Categories include technical documents, support and community resources, tools and software, and quick access to sample or buy.

**Table 3. Related Links**

PARTS	PRODUCT FOLDER	SAMPLE & BUY	TECHNICAL DOCUMENTS	TOOLS & SOFTWARE	SUPPORT & COMMUNITY
TLV431	<a href="#">Click here</a>	<a href="#">Click here</a>	<a href="#">Click here</a>	<a href="#">Click here</a>	<a href="#">Click here</a>
TLV431A	<a href="#">Click here</a>	<a href="#">Click here</a>	<a href="#">Click here</a>	<a href="#">Click here</a>	<a href="#">Click here</a>
TLV431B	<a href="#">Click here</a>	<a href="#">Click here</a>	<a href="#">Click here</a>	<a href="#">Click here</a>	<a href="#">Click here</a>

### 12.3 Receiving Notification of Documentation Updates

To receive notification of documentation updates, navigate to the device product folder on ti.com. In the upper right corner, click on *Alert me* to register and receive a weekly digest of any product information that has changed. For change details, review the revision history included in any revised document.

### 12.4 Community Resources

The following links connect to TI community resources. Linked contents are provided "AS IS" by the respective contributors. They do not constitute TI specifications and do not necessarily reflect TI's views; see TI's [Terms of Use](#).

**TI E2E™ Online Community** *TI's Engineer-to-Engineer (E2E) Community*. Created to foster collaboration among engineers. At e2e.ti.com, you can ask questions, share knowledge, explore ideas and help solve problems with fellow engineers.

**Design Support** *TI's Design Support* Quickly find helpful E2E forums along with design support tools and contact information for technical support.

### 12.5 Trademarks

E2E is a trademark of Texas Instruments.  
 All other trademarks are the property of their respective owners.

### 12.6 Electrostatic Discharge Caution



These devices have limited built-in ESD protection. The leads should be shorted together or the device placed in conductive foam during storage or handling to prevent electrostatic damage to the MOS gates.

### 12.7 Glossary

[SLYZ022](#) — *TI Glossary*.

This glossary lists and explains terms, acronyms, and definitions.

## 13 Mechanical, Packaging, and Orderable Information

The following pages include mechanical packaging and orderable information. This information is the most current data available for the designated devices. This data is subject to change without notice and revision of this document. For browser based versions of this data sheet, refer to the left hand navigation.

**PACKAGING INFORMATION**

Orderable Device	Status (1)	Package Type	Package Drawing	Pins	Package Qty	Eco Plan (2)	Lead/Ball Finish (6)	MSL Peak Temp (3)	Op Temp (°C)	Device Marking (4/5)	Samples
TLV431ACDBVR	ACTIVE	SOT-23	DBV	5	3000	Green (RoHS & no Sb/Br)	CU NIPDAU	Level-1-260C-UNLIM	0 to 70	(YAC6, YACC, YACI, YACN) (YACG, YAQL, YACS)	<a href="#">Samples</a>
TLV431ACDBVRE4	ACTIVE	SOT-23	DBV	5	3000	Green (RoHS & no Sb/Br)	CU NIPDAU	Level-1-260C-UNLIM	0 to 70	YACI	<a href="#">Samples</a>
TLV431ACDBVRG4	ACTIVE	SOT-23	DBV	5	3000	Green (RoHS & no Sb/Br)	CU NIPDAU	Level-1-260C-UNLIM	0 to 70	YACI	<a href="#">Samples</a>
TLV431ACDBVT	ACTIVE	SOT-23	DBV	5	250	Green (RoHS & no Sb/Br)	CU NIPDAU	Level-1-260C-UNLIM	0 to 70	(YAC6, YACC, YACI)  (YACG, YAQL, YACS)	<a href="#">Samples</a>
TLV431ACDBVTG4	ACTIVE	SOT-23	DBV	5	250	Green (RoHS & no Sb/Br)	CU NIPDAU	Level-1-260C-UNLIM	0 to 70	YACI	<a href="#">Samples</a>
TLV431ACDBZR	ACTIVE	SOT-23	DBZ	3	3000	Green (RoHS & no Sb/Br)	CU NIPDAU	Level-1-260C-UNLIM	0 to 70	(YAC6, YAC8, YACB)  (YAC3, YACS, YACU)	<a href="#">Samples</a>
TLV431ACDBZRG4	ACTIVE	SOT-23	DBZ	3	3000	Green (RoHS & no Sb/Br)	CU NIPDAU	Level-1-260C-UNLIM	0 to 70	(YAC6, YAC8, YACB)  (YAC3, YACS, YACU)	<a href="#">Samples</a>
TLV431ACL P	ACTIVE	TO-92	LP	3	1000	Pb-Free (RoHS)	CU SN	N / A for Pkg Type	0 to 70	V431AC	<a href="#">Samples</a>
TLV431ACLPE3	ACTIVE	TO-92	LP	3	1000	Pb-Free (RoHS)	CU SN	N / A for Pkg Type	0 to 70	V431AC	<a href="#">Samples</a>
TLV431ACLPR	ACTIVE	TO-92	LP	3	2000	Pb-Free (RoHS)	CU SN	N / A for Pkg Type	0 to 70	V431AC	<a href="#">Samples</a>
TLV431AID	ACTIVE	SOIC	D	8	75	Green (RoHS & no Sb/Br)	CU NIPDAU	Level-1-260C-UNLIM	-40 to 85	TY431A	<a href="#">Samples</a>
TLV431AIDBVR	ACTIVE	SOT-23	DBV	5	3000	Green (RoHS & no Sb/Br)	CU NIPDAU   CU SN	Level-1-260C-UNLIM	-40 to 85	(YAI6, YAIC, YAI1, YAIN) (YAI G, YAIL, YAIS)	<a href="#">Samples</a>
TLV431AIDBVRE4	ACTIVE	SOT-23	DBV	5	3000	Green (RoHS & no Sb/Br)	CU NIPDAU	Level-1-260C-UNLIM	-40 to 85	YAI1	<a href="#">Samples</a>

Orderable Device	Status (1)	Package Type	Package Drawing	Pins	Package Qty	Eco Plan (2)	Lead/Ball Finish (6)	MSL Peak Temp (3)	Op Temp (°C)	Device Marking (4/5)	Samples
TLV431AIDBVRG4	ACTIVE	SOT-23	DBV	5	3000	Green (RoHS & no Sb/Br)	CU NIPDAU	Level-1-260C-UNLIM	-40 to 85	YAI1	<a href="#">Samples</a>
TLV431AIDBVT	ACTIVE	SOT-23	DBV	5	250	Green (RoHS & no Sb/Br)	CU NIPDAU   CU SN	Level-1-260C-UNLIM	-40 to 85	(YAI6, YAIC, YAI1) (YAI8, YAIL, YAIS)	<a href="#">Samples</a>
TLV431AIDBVTE4	ACTIVE	SOT-23	DBV	5	250	Green (RoHS & no Sb/Br)	CU NIPDAU	Level-1-260C-UNLIM	-40 to 85	YAI1	<a href="#">Samples</a>
TLV431AIDBVTG4	ACTIVE	SOT-23	DBV	5	250	Green (RoHS & no Sb/Br)	CU NIPDAU	Level-1-260C-UNLIM	-40 to 85	YAI1	<a href="#">Samples</a>
TLV431AIDBZR	ACTIVE	SOT-23	DBZ	3	3000	Green (RoHS & no Sb/Br)	CU NIPDAU	Level-1-260C-UNLIM	-40 to 85	(YAI6, YAI8, YAIB) (YAI3, YAIS, YAIU)	<a href="#">Samples</a>
TLV431AIDBZRG4	ACTIVE	SOT-23	DBZ	3	3000	Green (RoHS & no Sb/Br)	CU NIPDAU	Level-1-260C-UNLIM	-40 to 85	(YAI6, YAI8, YAIB) (YAI3, YAIS, YAIU)	<a href="#">Samples</a>
TLV431AIDE4	ACTIVE	SOIC	D	8	75	Green (RoHS & no Sb/Br)	CU NIPDAU	Level-1-260C-UNLIM	-40 to 85	TY431A	<a href="#">Samples</a>
TLV431AIDR	ACTIVE	SOIC	D	8	2500	Green (RoHS & no Sb/Br)	CU NIPDAU	Level-1-260C-UNLIM	-40 to 85	TY431A	<a href="#">Samples</a>
TLV431AIDRE4	ACTIVE	SOIC	D	8	2500	Green (RoHS & no Sb/Br)	CU NIPDAU	Level-1-260C-UNLIM	-40 to 85	TY431A	<a href="#">Samples</a>
TLV431AILP	ACTIVE	TO-92	LP	3	1000	Pb-Free (RoHS)	CU SN	N / A for Pkg Type	-40 to 85	V431AI	<a href="#">Samples</a>
TLV431AILPE3	ACTIVE	TO-92	LP	3	1000	Pb-Free (RoHS)	CU SN	N / A for Pkg Type	-40 to 85	V431AI	<a href="#">Samples</a>
TLV431AILPM	ACTIVE	TO-92	LP	3	2000	Pb-Free (RoHS)	CU SN	N / A for Pkg Type	-40 to 85	V431AI	<a href="#">Samples</a>
TLV431AILPR	ACTIVE	TO-92	LP	3	2000	Pb-Free (RoHS)	CU SN	N / A for Pkg Type	-40 to 85	V431AI	<a href="#">Samples</a>
TLV431AILPRE3	ACTIVE	TO-92	LP	3	2000	Pb-Free (RoHS)	CU SN	N / A for Pkg Type	-40 to 85	V431AI	<a href="#">Samples</a>
TLV431AQPK	ACTIVE	SOT-89	PK	3	1000	Green (RoHS & no Sb/Br)	CU SN	Level-2-260C-1 YEAR	-40 to 125	VA	<a href="#">Samples</a>

Orderable Device	Status (1)	Package Type	Package Drawing	Pins	Package Qty	Eco Plan (2)	Lead/Ball Finish (6)	MSL Peak Temp (3)	Op Temp (°C)	Device Marking (4/5)	Samples
TLV431AQPKG3	ACTIVE	SOT-89	PK	3	1000	Green (RoHS & no Sb/Br)	CU SN	Level-2-260C-1 YEAR	-40 to 125	VA	<a href="#">Samples</a>
TLV431BCDBVR	ACTIVE	SOT-23	DBV	5	3000	Green (RoHS & no Sb/Br)	CU NIPDAU   CU SN	Level-1-260C-UNLIM	0 to 70	(Y3GG, Y3GJ, Y3GU)	<a href="#">Samples</a>
TLV431BCDBVRG4	ACTIVE	SOT-23	DBV	5	3000	Green (RoHS & no Sb/Br)	CU NIPDAU	Level-1-260C-UNLIM	0 to 70	Y3GG	<a href="#">Samples</a>
TLV431BCDBVT	ACTIVE	SOT-23	DBV	5	250	Green (RoHS & no Sb/Br)	CU NIPDAU   CU SN	Level-1-260C-UNLIM	0 to 70	(Y3GG, Y3GJ, Y3GU)	<a href="#">Samples</a>
TLV431BCDBVTG4	ACTIVE	SOT-23	DBV	5	250	Green (RoHS & no Sb/Br)	CU NIPDAU	Level-1-260C-UNLIM	0 to 70	Y3GG	<a href="#">Samples</a>
TLV431BCDBZR	ACTIVE	SOT-23	DBZ	3	3000	Green (RoHS & no Sb/Br)	CU NIPDAU	Level-1-260C-UNLIM	0 to 70	(Y3G3, Y3GS, Y3GU)	<a href="#">Samples</a>
TLV431BCDBZRG4	ACTIVE	SOT-23	DBZ	3	3000	Green (RoHS & no Sb/Br)	CU NIPDAU	Level-1-260C-UNLIM	0 to 70	(Y3G3, Y3GS, Y3GU)	<a href="#">Samples</a>
TLV431BCDBZT	ACTIVE	SOT-23	DBZ	3	250	Green (RoHS & no Sb/Br)	CU NIPDAU	Level-1-260C-UNLIM	0 to 70	(Y3GS, Y3GU)	<a href="#">Samples</a>
TLV431BCDBZTG4	ACTIVE	SOT-23	DBZ	3	250	Green (RoHS & no Sb/Br)	CU NIPDAU	Level-1-260C-UNLIM	0 to 70	(Y3GS, Y3GU)	<a href="#">Samples</a>
TLV431BCDCKR	ACTIVE	SC70	DCK	6	3000	Green (RoHS & no Sb/Br)	CU NIPDAU	Level-1-260C-UNLIM	0 to 70	YEU	<a href="#">Samples</a>
TLV431BCDCKT	ACTIVE	SC70	DCK	6	250	Green (RoHS & no Sb/Br)	CU NIPDAU	Level-1-260C-UNLIM	0 to 70	YEU	<a href="#">Samples</a>
TLV431BCLP	ACTIVE	TO-92	LP	3	1000	Pb-Free (RoHS)	CU SN	N / A for Pkg Type	0 to 70	TV431B	<a href="#">Samples</a>
TLV431BCLPR	ACTIVE	TO-92	LP	3	2000	Pb-Free (RoHS)	CU SN	N / A for Pkg Type	0 to 70	TV431B	<a href="#">Samples</a>
TLV431BCPK	ACTIVE	SOT-89	PK	3	1000	Green (RoHS & no Sb/Br)	CU SN	Level-2-260C-1 YEAR	0 to 70	VE	<a href="#">Samples</a>
TLV431BIDBVR	ACTIVE	SOT-23	DBV	5	3000	Green (RoHS & no Sb/Br)	CU NIPDAU   CU SN	Level-1-260C-UNLIM	-40 to 85	(Y3FJ, Y3FU)	<a href="#">Samples</a>
TLV431BIDBVRG4	ACTIVE	SOT-23	DBV	5	3000	Green (RoHS & no Sb/Br)	CU NIPDAU	Level-1-260C-UNLIM	-40 to 85	(Y3FJ, Y3FU)	<a href="#">Samples</a>
TLV431BIDBVT	ACTIVE	SOT-23	DBV	5	250	Green (RoHS & no Sb/Br)	CU NIPDAU   CU SN	Level-1-260C-UNLIM	-40 to 85	(Y3FJ, Y3FU)	<a href="#">Samples</a>
TLV431BIDBVTE4	ACTIVE	SOT-23	DBV	5	250	Green (RoHS & no Sb/Br)	CU SN	Level-1-260C-UNLIM	-40 to 85	(Y3FJ, Y3FU)	<a href="#">Samples</a>

Orderable Device	Status (1)	Package Type	Package Drawing	Pins	Package Qty	Eco Plan (2)	Lead/Ball Finish (6)	MSL Peak Temp (3)	Op Temp (°C)	Device Marking (4/5)	Samples
TLV431BIDBVTG4	ACTIVE	SOT-23	DBV	5	250	Green (RoHS & no Sb/Br)	CU NIPDAU	Level-1-260C-UNLIM	-40 to 85	(Y3FJ, Y3FU)	<a href="#">Samples</a>
TLV431BIDBZR	ACTIVE	SOT-23	DBZ	3	3000	Green (RoHS & no Sb/Br)	CU NIPDAU	Level-1-260C-UNLIM	-40 to 85	(Y3F3, Y3FS, Y3FU)	<a href="#">Samples</a>
TLV431BIDBZRG4	ACTIVE	SOT-23	DBZ	3	3000	Green (RoHS & no Sb/Br)	CU NIPDAU	Level-1-260C-UNLIM	-40 to 85	(Y3F3, Y3FS, Y3FU)	<a href="#">Samples</a>
TLV431BIDBZT	ACTIVE	SOT-23	DBZ	3	250	Green (RoHS & no Sb/Br)	CU NIPDAU	Level-1-260C-UNLIM	-40 to 85	(Y3FS, Y3FU)	<a href="#">Samples</a>
TLV431BIDBZTG4	ACTIVE	SOT-23	DBZ	3	250	TBD	Call TI	Call TI	-40 to 85	(Y3FS, Y3FU)	<a href="#">Samples</a>
TLV431BIDCKR	ACTIVE	SC70	DCK	6	3000	Green (RoHS & no Sb/Br)	CU NIPDAU	Level-1-260C-UNLIM	-40 to 85	YFU	<a href="#">Samples</a>
TLV431BIDCKT	ACTIVE	SC70	DCK	6	250	Green (RoHS & no Sb/Br)	CU NIPDAU	Level-1-260C-UNLIM	-40 to 85	YFU	<a href="#">Samples</a>
TLV431BIDCKTE4	ACTIVE	SC70	DCK	6	250	Green (RoHS & no Sb/Br)	CU NIPDAU	Level-1-260C-UNLIM	-40 to 85	YFU	<a href="#">Samples</a>
TLV431BILP	ACTIVE	TO-92	LP	3	1000	Pb-Free (RoHS)	CU SN	N / A for Pkg Type	-40 to 85	TY431B	<a href="#">Samples</a>
TLV431BILPR	ACTIVE	TO-92	LP	3	2000	Pb-Free (RoHS)	CU SN	N / A for Pkg Type	-40 to 85	TY431B	<a href="#">Samples</a>
TLV431BILPRE3	ACTIVE	TO-92	LP	3	2000	Pb-Free (RoHS)	CU SN	N / A for Pkg Type	-40 to 85	TY431B	<a href="#">Samples</a>
TLV431BIPK	ACTIVE	SOT-89	PK	3	1000	Green (RoHS & no Sb/Br)	CU SN	Level-2-260C-1 YEAR	-40 to 85	VF	<a href="#">Samples</a>
TLV431BQDBVR	ACTIVE	SOT-23	DBV	5	3000	Green (RoHS & no Sb/Br)	CU NIPDAU   CU SN	Level-1-260C-UNLIM	-40 to 125	(Y3HJ, Y3HU)	<a href="#">Samples</a>
TLV431BQDBVRE4	ACTIVE	SOT-23	DBV	5	3000	Green (RoHS & no Sb/Br)	CU SN	Level-1-260C-UNLIM	-40 to 125	(Y3HJ, Y3HU)	<a href="#">Samples</a>
TLV431BQDBVT	ACTIVE	SOT-23	DBV	5	250	Green (RoHS & no Sb/Br)	CU NIPDAU   CU SN	Level-1-260C-UNLIM	-40 to 125	(Y3HJ, Y3HU)	<a href="#">Samples</a>
TLV431BQDBVTE4	ACTIVE	SOT-23	DBV	5	250	Green (RoHS & no Sb/Br)	CU SN	Level-1-260C-UNLIM	-40 to 125	(Y3HJ, Y3HU)	<a href="#">Samples</a>
TLV431BQDBVTG4	ACTIVE	SOT-23	DBV	5	250	Green (RoHS & no Sb/Br)	CU NIPDAU	Level-1-260C-UNLIM	-40 to 125	(Y3HJ, Y3HU)	<a href="#">Samples</a>
TLV431BQDBZR	ACTIVE	SOT-23	DBZ	3	3000	Green (RoHS & no Sb/Br)	CU NIPDAU	Level-1-260C-UNLIM	-40 to 125	(Y3H3, Y3HS, Y3HU)	<a href="#">Samples</a>

Orderable Device	Status (1)	Package Type	Package Drawing	Pins	Package Qty	Eco Plan (2)	Lead/Ball Finish (6)	MSL Peak Temp (3)	Op Temp (°C)	Device Marking (4/5)	Samples
TLV431BQDBZRG4	ACTIVE	SOT-23	DBZ	3	3000	Green (RoHS & no Sb/Br)	CU NIPDAU	Level-1-260C-UNLIM	-40 to 125	(Y3H3, Y3HS, Y3HU)	<a href="#">Samples</a>
TLV431BQDBZT	ACTIVE	SOT-23	DBZ	3	250	Green (RoHS & no Sb/Br)	CU NIPDAU	Level-1-260C-UNLIM	-40 to 125	(Y3HS, Y3HU)	<a href="#">Samples</a>
TLV431BQDBZTG4	ACTIVE	SOT-23	DBZ	3	250	Green (RoHS & no Sb/Br)	CU NIPDAU	Level-1-260C-UNLIM	-40 to 125	(Y3HS, Y3HU)	<a href="#">Samples</a>
TLV431BQDCKR	ACTIVE	SC70	DCK	6	3000	Green (RoHS & no Sb/Br)	CU NIPDAU	Level-1-260C-UNLIM	-40 to 125	YGU	<a href="#">Samples</a>
TLV431BQDCKT	ACTIVE	SC70	DCK	6	250	Green (RoHS & no Sb/Br)	CU NIPDAU	Level-1-260C-UNLIM	-40 to 125	YGU	<a href="#">Samples</a>
TLV431BQLP	ACTIVE	TO-92	LP	3	1000	Pb-Free (RoHS)	CU SN	N / A for Pkg Type	-40 to 125	TQ431B	<a href="#">Samples</a>
TLV431BQLPR	ACTIVE	TO-92	LP	3	2000	Pb-Free (RoHS)	CU SN	N / A for Pkg Type	-40 to 125	TQ431B	<a href="#">Samples</a>
TLV431BQPK	ACTIVE	SOT-89	PK	3	1000	Green (RoHS & no Sb/Br)	CU SN	Level-2-260C-1 YEAR	-40 to 125	V6	<a href="#">Samples</a>
TLV431CDBVR	ACTIVE	SOT-23	DBV	5	3000	Green (RoHS & no Sb/Br)	CU NIPDAU   CU SN	Level-1-260C-UNLIM	0 to 70	(Y3C6, Y3CI) (Y3CG, Y3CS)	<a href="#">Samples</a>
TLV431CDBVRG4	ACTIVE	SOT-23	DBV	5	3000	Green (RoHS & no Sb/Br)	CU NIPDAU	Level-1-260C-UNLIM	0 to 70	Y3CI	<a href="#">Samples</a>
TLV431CDBVT	ACTIVE	SOT-23	DBV	5	250	Green (RoHS & no Sb/Br)	CU NIPDAU   CU SN	Level-1-260C-UNLIM	0 to 70	(Y3C6, Y3CI) (Y3CG, Y3CS)	<a href="#">Samples</a>
TLV431CDBVTG4	ACTIVE	SOT-23	DBV	5	250	Green (RoHS & no Sb/Br)	CU NIPDAU	Level-1-260C-UNLIM	0 to 70	Y3CI	<a href="#">Samples</a>
TLV431CDBZR	ACTIVE	SOT-23	DBZ	3	3000	Green (RoHS & no Sb/Br)	CU NIPDAU	Level-1-260C-UNLIM	0 to 70	(Y3C6, Y3C8, Y3CB) (Y3C3, Y3CS, Y3CU)	<a href="#">Samples</a>
TLV431CDBZRG4	ACTIVE	SOT-23	DBZ	3	3000	TBD	Call TI	Call TI	0 to 70	(Y3C6, Y3C8, Y3CB) (Y3C3, Y3CS, Y3CU)	<a href="#">Samples</a>
TLV431CLP	ACTIVE	TO-92	LP	3	1000	Pb-Free (RoHS)	CU SN	N / A for Pkg Type	0 to 70	V431C	<a href="#">Samples</a>
TLV431CLPE3	ACTIVE	TO-92	LP	3	1000	Pb-Free (RoHS)	CU SN	N / A for Pkg Type	0 to 70	V431C	<a href="#">Samples</a>

Orderable Device	Status (1)	Package Type	Package Drawing	Pins	Package Qty	Eco Plan (2)	Lead/Ball Finish (6)	MSL Peak Temp (3)	Op Temp (°C)	Device Marking (4/5)	Samples
TLV431CLPR	ACTIVE	TO-92	LP	3	2000	Pb-Free (RoHS)	CU SN	N / A for Pkg Type	0 to 70	V431C	<a href="#">Samples</a>
TLV431IDBVR	ACTIVE	SOT-23	DBV	5	3000	Green (RoHS & no Sb/Br)	CU NIPDAU   CU SN	Level-1-260C-UNLIM	-40 to 85	(Y3I6, Y3I1) (Y3IG, Y3IS)	<a href="#">Samples</a>
TLV431IDBVRG4	ACTIVE	SOT-23	DBV	5	3000	Green (RoHS & no Sb/Br)	CU NIPDAU	Level-1-260C-UNLIM	-40 to 85	Y3I1	<a href="#">Samples</a>
TLV431IDBVT	ACTIVE	SOT-23	DBV	5	250	Green (RoHS & no Sb/Br)	CU NIPDAU   CU SN	Level-1-260C-UNLIM	-40 to 85	(Y3I6, Y3I1) (Y3IG, Y3IS)	<a href="#">Samples</a>
TLV431IDBVTG4	ACTIVE	SOT-23	DBV	5	250	Green (RoHS & no Sb/Br)	CU NIPDAU	Level-1-260C-UNLIM	-40 to 85	Y3I1	<a href="#">Samples</a>
TLV431IDBZR	ACTIVE	SOT-23	DBZ	3	3000	Green (RoHS & no Sb/Br)	CU NIPDAU	Level-1-260C-UNLIM	-40 to 85	(Y3I6, Y3IB) (Y3IS, Y3IU)	<a href="#">Samples</a>
TLV431IDBZRG4	ACTIVE	SOT-23	DBZ	3	3000	Green (RoHS & no Sb/Br)	CU NIPDAU	Level-1-260C-UNLIM	-40 to 85	(Y3I6, Y3IB) (Y3IS, Y3IU)	<a href="#">Samples</a>
TLV431ILP	ACTIVE	TO-92	LP	3	1000	Pb-Free (RoHS)	CU SN	N / A for Pkg Type	-40 to 85	V4311	<a href="#">Samples</a>
TLV431ILPE3	ACTIVE	TO-92	LP	3	1000	Pb-Free (RoHS)	CU SN	N / A for Pkg Type	-40 to 85	V4311	<a href="#">Samples</a>
TLV431ILPR	ACTIVE	TO-92	LP	3	2000	Pb-Free (RoHS)	CU SN	N / A for Pkg Type	-40 to 85	V4311	<a href="#">Samples</a>
TLV431QPK	ACTIVE	SOT-89	PK	3	1000	Green (RoHS & no Sb/Br)	CU SN	Level-2-260C-1 YEAR	-40 to 125	VB	<a href="#">Samples</a>
TLV431QPKG3	ACTIVE	SOT-89	PK	3	1000	Green (RoHS & no Sb/Br)	CU SN	Level-2-260C-1 YEAR	-40 to 125	VB	<a href="#">Samples</a>

(1) The marketing status values are defined as follows:

**ACTIVE:** Product device recommended for new designs.

**LIFEBUY:** TI has announced that the device will be discontinued, and a lifetime-buy period is in effect.

**NRND:** Not recommended for new designs. Device is in production to support existing customers, but TI does not recommend using this part in a new design.

**PREVIEW:** Device has been announced but is not in production. Samples may or may not be available.

**OBSELETE:** TI has discontinued the production of the device.

(2) **RoHS:** TI defines "RoHS" to mean semiconductor products that are compliant with the current EU RoHS requirements for all 10 RoHS substances, including the requirement that RoHS substance do not exceed 0.1% by weight in homogeneous materials. Where designed to be soldered at high temperatures, "RoHS" products are suitable for use in specified lead-free processes. TI may reference these types of products as "Pb-Free".

**RoHS Exempt:** TI defines "RoHS Exempt" to mean products that contain lead but are compliant with EU RoHS pursuant to a specific EU RoHS exemption.

**Green:** TI defines "Green" to mean the content of Chlorine (Cl) and Bromine (Br) based flame retardants meet JS709B low halogen requirements of <=1000ppm threshold. Antimony trioxide based flame retardants must also meet the <=1000ppm threshold requirement.

- (3) MSL, Peak Temp. - The Moisture Sensitivity Level rating according to the JEDEC industry standard classifications, and peak solder temperature.
- (4) There may be additional marking, which relates to the logo, the lot trace code information, or the environmental category on the device.
- (5) Multiple Device Markings will be inside parentheses. Only one Device Marking contained in parentheses and separated by a "~" will appear on a device. If a line is indented then it is a continuation of the previous line and the two combined represent the entire Device Marking for that device.
- (6) Lead/Ball Finish - Orderable Devices may have multiple material finish options. Finish options are separated by a vertical ruled line. Lead/Ball Finish values may wrap to two lines if the finish value exceeds the maximum column width.

**Important Information and Disclaimer:**The information provided on this page represents TI's knowledge and belief as of the date that it is provided. TI bases its knowledge and belief on information provided by third parties, and makes no representation or warranty as to the accuracy of such information. Efforts are underway to better integrate information from third parties. TI has taken and continues to take reasonable steps to provide representative and accurate information but may not have conducted destructive testing or chemical analysis on incoming materials and chemicals. TI and TI suppliers consider certain information to be proprietary, and thus CAS numbers and other limited information may not be available for release.

In no event shall TI's liability arising out of such information exceed the total purchase price of the TI part(s) at issue in this document sold by TI to Customer on an annual basis.

**OTHER QUALIFIED VERSIONS OF TLV431A, TLV431B :**

- Automotive: [TLV431A-Q1](#), [TLV431B-Q1](#)

**NOTE: Qualified Version Definitions:**

- Automotive - Q100 devices qualified for high-reliability automotive applications targeting zero defects

## TAPE AND REEL INFORMATION



### QUADRANT ASSIGNMENTS FOR PIN 1 ORIENTATION IN TAPE



\*All dimensions are nominal

Device	Package Type	Package Drawing	Pins	SPQ	Reel Diameter (mm)	Reel Width W1 (mm)	A0 (mm)	B0 (mm)	K0 (mm)	P1 (mm)	W (mm)	Pin1 Quadrant
TLV431ACDBVR	SOT-23	DBV	5	3000	178.0	9.0	3.23	3.17	1.37	4.0	8.0	Q3
TLV431ACDBVR	SOT-23	DBV	5	3000	180.0	8.4	3.23	3.17	1.37	4.0	8.0	Q3
TLV431ACDBVRG4	SOT-23	DBV	5	3000	178.0	9.0	3.23	3.17	1.37	4.0	8.0	Q3
TLV431ACDBVT	SOT-23	DBV	5	250	178.0	9.0	3.23	3.17	1.37	4.0	8.0	Q3
TLV431ACDBVTG4	SOT-23	DBV	5	250	178.0	9.0	3.23	3.17	1.37	4.0	8.0	Q3
TLV431ACDBZR	SOT-23	DBZ	3	3000	180.0	8.4	3.15	2.77	1.22	4.0	8.0	Q3
TLV431AIDBVR	SOT-23	DBV	5	3000	178.0	9.0	3.23	3.17	1.37	4.0	8.0	Q3
TLV431AIDBVRG4	SOT-23	DBV	5	3000	178.0	9.0	3.23	3.17	1.37	4.0	8.0	Q3
TLV431AIDBVT	SOT-23	DBV	5	250	178.0	9.0	3.23	3.17	1.37	4.0	8.0	Q3
TLV431AIDBVTG4	SOT-23	DBV	5	250	178.0	9.0	3.23	3.17	1.37	4.0	8.0	Q3
TLV431AIDBZR	SOT-23	DBZ	3	3000	179.0	8.4	3.15	2.95	1.22	4.0	8.0	Q3
TLV431AIDR	SOIC	D	8	2500	330.0	12.4	6.4	5.2	2.1	8.0	12.0	Q1
TLV431AQPK	SOT-89	PK	3	1000	180.0	12.4	4.91	4.52	1.9	8.0	12.0	Q3
TLV431BCDBVR	SOT-23	DBV	5	3000	178.0	9.0	3.3	3.2	1.4	4.0	8.0	Q3
TLV431BCDBVR	SOT-23	DBV	5	3000	178.0	9.0	3.23	3.17	1.37	4.0	8.0	Q3
TLV431BCDBVRG4	SOT-23	DBV	5	3000	178.0	9.0	3.23	3.17	1.37	4.0	8.0	Q3
TLV431BCDBVT	SOT-23	DBV	5	250	178.0	9.0	3.23	3.17	1.37	4.0	8.0	Q3
TLV431BCDBVT	SOT-23	DBV	5	250	178.0	9.0	3.3	3.2	1.4	4.0	8.0	Q3

Device	Package Type	Package Drawing	Pins	SPQ	Reel Diameter (mm)	Reel Width W1 (mm)	A0 (mm)	B0 (mm)	K0 (mm)	P1 (mm)	W (mm)	Pin1 Quadrant
TLV431BCDBVTG4	SOT-23	DBV	5	250	178.0	9.0	3.23	3.17	1.37	4.0	8.0	Q3
TLV431BCDBZR	SOT-23	DBZ	3	3000	180.0	8.4	3.15	2.77	1.22	4.0	8.0	Q3
TLV431BCDBZT	SOT-23	DBZ	3	250	180.0	8.4	3.15	2.77	1.22	4.0	8.0	Q3
TLV431BCDBZTG4	SOT-23	DBZ	3	250	180.0	8.4	3.15	2.77	1.22	4.0	8.0	Q3
TLV431BCDCKR	SC70	DCK	6	3000	179.0	8.4	2.2	2.5	1.2	4.0	8.0	Q3
TLV431BCDCKT	SC70	DCK	6	250	179.0	8.4	2.2	2.5	1.2	4.0	8.0	Q3
TLV431BCPK	SOT-89	PK	3	1000	180.0	12.4	4.91	4.52	1.9	8.0	12.0	Q3
TLV431BIDBVR	SOT-23	DBV	5	3000	178.0	9.0	3.3	3.2	1.4	4.0	8.0	Q3
TLV431BIDBVR	SOT-23	DBV	5	3000	179.0	8.4	3.2	3.2	1.4	4.0	8.0	Q3
TLV431BIDBVT	SOT-23	DBV	5	250	180.0	8.4	3.2	3.2	1.4	4.0	8.0	Q3
TLV431BIDBVT	SOT-23	DBV	5	250	178.0	9.0	3.3	3.2	1.4	4.0	8.0	Q3
TLV431BIDBZR	SOT-23	DBZ	3	3000	180.0	8.4	3.15	2.77	1.22	4.0	8.0	Q3
TLV431BIDBZR	SOT-23	DBZ	3	3000	178.0	9.2	3.15	2.77	1.22	4.0	8.0	Q3
TLV431BIDBZT	SOT-23	DBZ	3	250	180.0	8.4	3.15	2.77	1.22	4.0	8.0	Q3
TLV431BIDCKR	SC70	DCK	6	3000	179.0	8.4	2.2	2.5	1.2	4.0	8.0	Q3
TLV431BIDCKT	SC70	DCK	6	250	179.0	8.4	2.2	2.5	1.2	4.0	8.0	Q3
TLV431BIPK	SOT-89	PK	3	1000	180.0	12.4	4.91	4.52	1.9	8.0	12.0	Q3
TLV431BQDBVR	SOT-23	DBV	5	3000	178.0	9.0	3.3	3.2	1.4	4.0	8.0	Q3
TLV431BQDBVR	SOT-23	DBV	5	3000	179.0	8.4	3.2	3.2	1.4	4.0	8.0	Q3
TLV431BQDBVT	SOT-23	DBV	5	250	178.0	9.0	3.3	3.2	1.4	4.0	8.0	Q3
TLV431BQDBVT	SOT-23	DBV	5	250	180.0	8.4	3.2	3.2	1.4	4.0	8.0	Q3
TLV431BQDBZR	SOT-23	DBZ	3	3000	180.0	8.4	3.15	2.77	1.22	4.0	8.0	Q3
TLV431BQDBZT	SOT-23	DBZ	3	250	180.0	8.4	3.15	2.77	1.22	4.0	8.0	Q3
TLV431BQDBZTG4	SOT-23	DBZ	3	250	180.0	8.4	3.15	2.77	1.22	4.0	8.0	Q3
TLV431BQDCKR	SC70	DCK	6	3000	179.0	8.4	2.2	2.5	1.2	4.0	8.0	Q3
TLV431BQDCKT	SC70	DCK	6	250	179.0	8.4	2.2	2.5	1.2	4.0	8.0	Q3
TLV431BQPK	SOT-89	PK	3	1000	180.0	12.4	4.91	4.52	1.9	8.0	12.0	Q3
TLV431CDBVR	SOT-23	DBV	5	3000	180.0	8.4	3.23	3.17	1.37	4.0	8.0	Q3
TLV431CDBVR	SOT-23	DBV	5	3000	178.0	9.0	3.23	3.17	1.37	4.0	8.0	Q3
TLV431CDBVRG4	SOT-23	DBV	5	3000	178.0	9.0	3.23	3.17	1.37	4.0	8.0	Q3
TLV431CDBVT	SOT-23	DBV	5	250	178.0	9.0	3.23	3.17	1.37	4.0	8.0	Q3
TLV431CDBVT	SOT-23	DBV	5	250	180.0	8.4	3.23	3.17	1.37	4.0	8.0	Q3
TLV431CDBVTG4	SOT-23	DBV	5	250	178.0	9.0	3.23	3.17	1.37	4.0	8.0	Q3
TLV431CDBZR	SOT-23	DBZ	3	3000	180.0	8.4	3.15	2.77	1.22	4.0	8.0	Q3
TLV431IDBVR	SOT-23	DBV	5	3000	178.0	9.0	3.3	3.2	1.4	4.0	8.0	Q3
TLV431IDBVRG4	SOT-23	DBV	5	3000	178.0	9.0	3.3	3.2	1.4	4.0	8.0	Q3
TLV431IDBVT	SOT-23	DBV	5	250	178.0	9.0	3.23	3.17	1.37	4.0	8.0	Q3
TLV431IDBVTG4	SOT-23	DBV	5	250	178.0	9.0	3.23	3.17	1.37	4.0	8.0	Q3
TLV431IDBZR	SOT-23	DBZ	3	3000	179.0	8.4	3.15	2.95	1.22	4.0	8.0	Q3
TLV431QPK	SOT-89	PK	3	1000	180.0	12.4	4.91	4.52	1.9	8.0	12.0	Q3

**TAPE AND REEL BOX DIMENSIONS**

\*All dimensions are nominal

Device	Package Type	Package Drawing	Pins	SPQ	Length (mm)	Width (mm)	Height (mm)
TLV431ACDBVR	SOT-23	DBV	5	3000	180.0	180.0	18.0
TLV431ACDBVR	SOT-23	DBV	5	3000	183.0	183.0	20.0
TLV431ACDBVRG4	SOT-23	DBV	5	3000	180.0	180.0	18.0
TLV431ACDBVT	SOT-23	DBV	5	250	180.0	180.0	18.0
TLV431ACDBVTG4	SOT-23	DBV	5	250	180.0	180.0	18.0
TLV431ACDBZR	SOT-23	DBZ	3	3000	183.0	183.0	20.0
TLV431AIDBVR	SOT-23	DBV	5	3000	180.0	180.0	18.0
TLV431AIDBVRG4	SOT-23	DBV	5	3000	180.0	180.0	18.0
TLV431AIDBVT	SOT-23	DBV	5	250	180.0	180.0	18.0
TLV431AIDBVTG4	SOT-23	DBV	5	250	180.0	180.0	18.0
TLV431AIDBZR	SOT-23	DBZ	3	3000	203.0	203.0	35.0
TLV431AIDR	SOIC	D	8	2500	340.5	338.1	20.6
TLV431AQPK	SOT-89	PK	3	1000	340.0	340.0	38.0
TLV431BCDBVR	SOT-23	DBV	5	3000	180.0	180.0	18.0
TLV431BCDBVR	SOT-23	DBV	5	3000	180.0	180.0	18.0
TLV431BCDBVRG4	SOT-23	DBV	5	3000	180.0	180.0	18.0
TLV431BCDBVT	SOT-23	DBV	5	250	180.0	180.0	18.0
TLV431BCDBVT	SOT-23	DBV	5	250	180.0	180.0	18.0
TLV431BCDBVTG4	SOT-23	DBV	5	250	180.0	180.0	18.0
TLV431BCDBZR	SOT-23	DBZ	3	3000	183.0	183.0	20.0

Device	Package Type	Package Drawing	Pins	SPQ	Length (mm)	Width (mm)	Height (mm)
TLV431BCDBZT	SOT-23	DBZ	3	250	183.0	183.0	20.0
TLV431BCDBZTG4	SOT-23	DBZ	3	250	183.0	183.0	20.0
TLV431BCDCKR	SC70	DCK	6	3000	203.0	203.0	35.0
TLV431BCDCKT	SC70	DCK	6	250	203.0	203.0	35.0
TLV431BCPK	SOT-89	PK	3	1000	340.0	340.0	38.0
TLV431BIDBVR	SOT-23	DBV	5	3000	180.0	180.0	18.0
TLV431BIDBVR	SOT-23	DBV	5	3000	203.0	203.0	35.0
TLV431BIDBVT	SOT-23	DBV	5	250	203.0	203.0	35.0
TLV431BIDBVT	SOT-23	DBV	5	250	180.0	180.0	18.0
TLV431BIDBZR	SOT-23	DBZ	3	3000	183.0	183.0	20.0
TLV431BIDBZR	SOT-23	DBZ	3	3000	180.0	180.0	18.0
TLV431BIDBZT	SOT-23	DBZ	3	250	183.0	183.0	20.0
TLV431BIDCKR	SC70	DCK	6	3000	203.0	203.0	35.0
TLV431BIDCKT	SC70	DCK	6	250	203.0	203.0	35.0
TLV431BIPK	SOT-89	PK	3	1000	340.0	340.0	38.0
TLV431BQDBVR	SOT-23	DBV	5	3000	180.0	180.0	18.0
TLV431BQDBVR	SOT-23	DBV	5	3000	203.0	203.0	35.0
TLV431BQDBVT	SOT-23	DBV	5	250	180.0	180.0	18.0
TLV431BQDBVT	SOT-23	DBV	5	250	203.0	203.0	35.0
TLV431BQDBZR	SOT-23	DBZ	3	3000	183.0	183.0	20.0
TLV431BQDBZT	SOT-23	DBZ	3	250	183.0	183.0	20.0
TLV431BQDBZTG4	SOT-23	DBZ	3	250	183.0	183.0	20.0
TLV431BQDCKR	SC70	DCK	6	3000	203.0	203.0	35.0
TLV431BQDCKT	SC70	DCK	6	250	203.0	203.0	35.0
TLV431BQPK	SOT-89	PK	3	1000	340.0	340.0	38.0
TLV431CDBVR	SOT-23	DBV	5	3000	183.0	183.0	20.0
TLV431CDBVR	SOT-23	DBV	5	3000	180.0	180.0	18.0
TLV431CDBVRG4	SOT-23	DBV	5	3000	180.0	180.0	18.0
TLV431CDBVT	SOT-23	DBV	5	250	180.0	180.0	18.0
TLV431CDBVT	SOT-23	DBV	5	250	183.0	183.0	20.0
TLV431CDBVTG4	SOT-23	DBV	5	250	180.0	180.0	18.0
TLV431CDBZR	SOT-23	DBZ	3	3000	183.0	183.0	20.0
TLV431IDBVR	SOT-23	DBV	5	3000	180.0	180.0	18.0
TLV431IDBVRG4	SOT-23	DBV	5	3000	180.0	180.0	18.0
TLV431IDBVT	SOT-23	DBV	5	250	180.0	180.0	18.0
TLV431IDBVTG4	SOT-23	DBV	5	250	180.0	180.0	18.0
TLV431IDBZR	SOT-23	DBZ	3	3000	203.0	203.0	35.0
TLV431QPK	SOT-89	PK	3	1000	340.0	340.0	38.0

## GENERIC PACKAGE VIEW

**DBZ 3**

**SOT-23 - 1.12 mm max height**

SMALL OUTLINE TRANSISTOR



Images above are just a representation of the package family, actual package may vary.  
Refer to the product data sheet for package details.

4203227/C

DBZ0003A



# PACKAGE OUTLINE

SOT-23 - 1.12 mm max height

SMALL OUTLINE TRANSISTOR

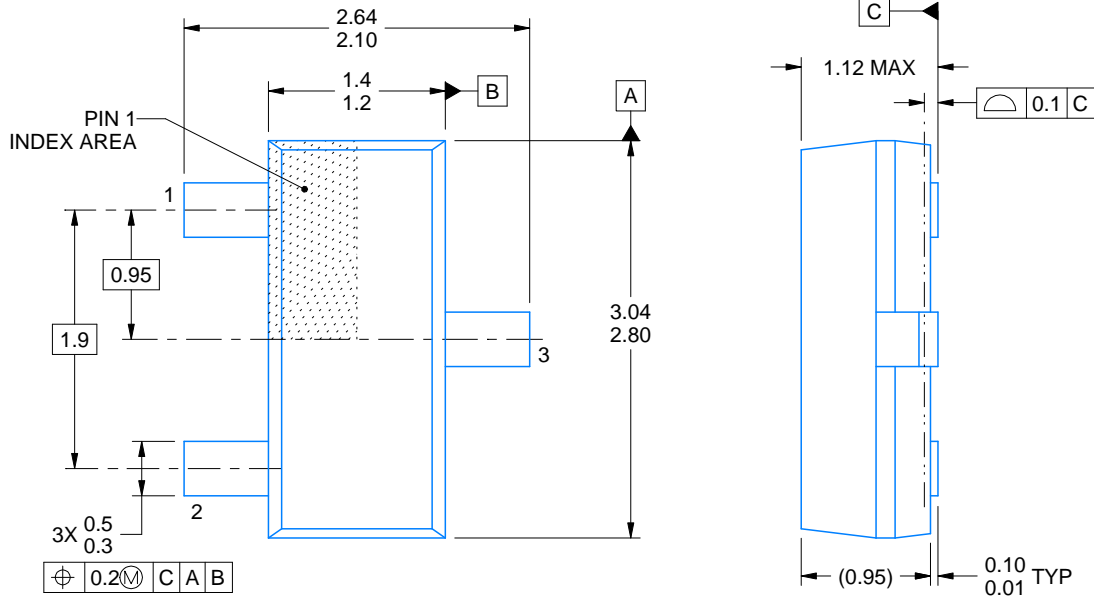

4214838/C 04/2017

NOTES:

1. All linear dimensions are in millimeters. Any dimensions in parenthesis are for reference only. Dimensioning and tolerancing per ASME Y14.5M.
2. This drawing is subject to change without notice.
3. Reference JEDEC registration TO-236, except minimum foot length.

# EXAMPLE BOARD LAYOUT

DBZ0003A

SOT-23 - 1.12 mm max height

SMALL OUTLINE TRANSISTOR



LAND PATTERN EXAMPLE  
SCALE:15X



SOLDER MASK DETAILS

4214838/C 04/2017

NOTES: (continued)

4. Publication IPC-7351 may have alternate designs.
5. Solder mask tolerances between and around signal pads can vary based on board fabrication site.

# EXAMPLE STENCIL DESIGN

DBZ0003A

SOT-23 - 1.12 mm max height

SMALL OUTLINE TRANSISTOR

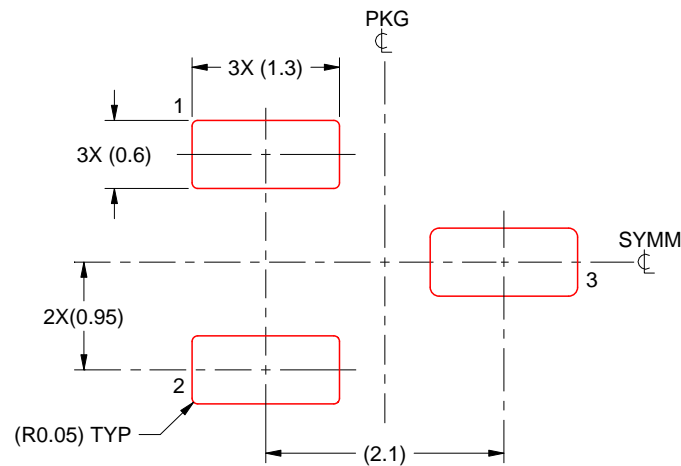

SOLDER PASTE EXAMPLE  
BASED ON 0.125 THICK STENCIL  
SCALE:15X

4214838/C 04/2017

NOTES: (continued)

6. Laser cutting apertures with trapezoidal walls and rounded corners may offer better paste release. IPC-7525 may have alternate design recommendations.
7. Board assembly site may have different recommendations for stencil design.

PK (R-PSS0-F3)

PLASTIC SINGLE-IN-LINE PACKAGE

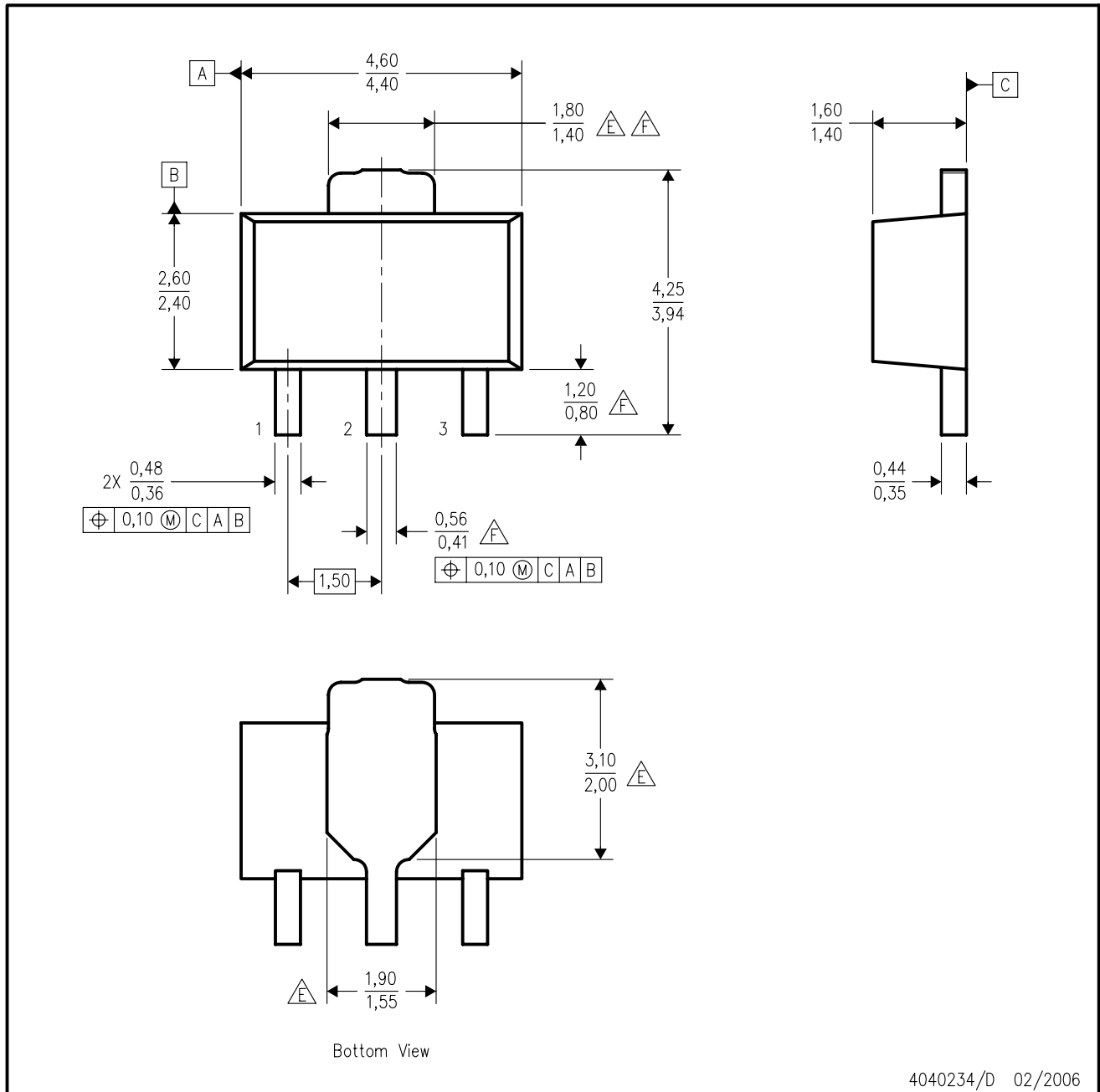

4040234/D 02/2006

- NOTES:
- All linear dimensions are in millimeters. Dimensioning and tolerancing per ASME Y14.5M-1994.
  - This drawing is subject to change without notice.
  - The center lead is in electrical contact with the tab.
  - Body dimensions do not include mold flash or protrusion. Mold flash and protrusion not to exceed 0.15 per side.
- △E Thermal pad contour optional within these dimensions.
- △F Falls within JEDEC TO-243 variation AA, except minimum lead length, pin 2 minimum lead width, minimum tab width.

DCK (R-PDSO-G6)

PLASTIC SMALL-OUTLINE PACKAGE

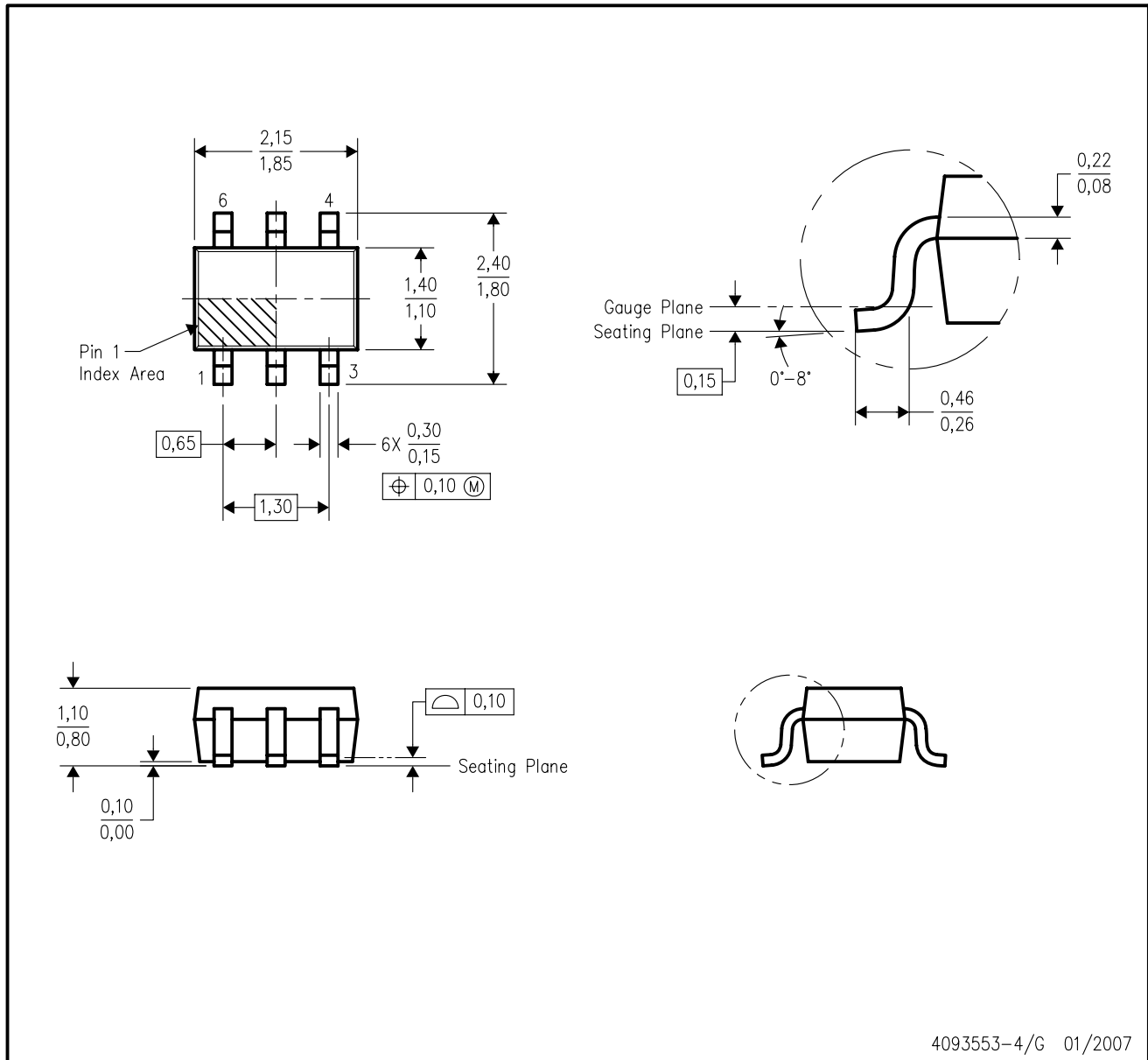

- NOTES:
- A. All linear dimensions are in millimeters.
  - B. This drawing is subject to change without notice.
  - C. Body dimensions do not include mold flash or protrusion. Mold flash and protrusion shall not exceed 0.15 per side.
  - D. Falls within JEDEC MO-203 variation AB.

DCK (R-PDSO-G6)

PLASTIC SMALL OUTLINE

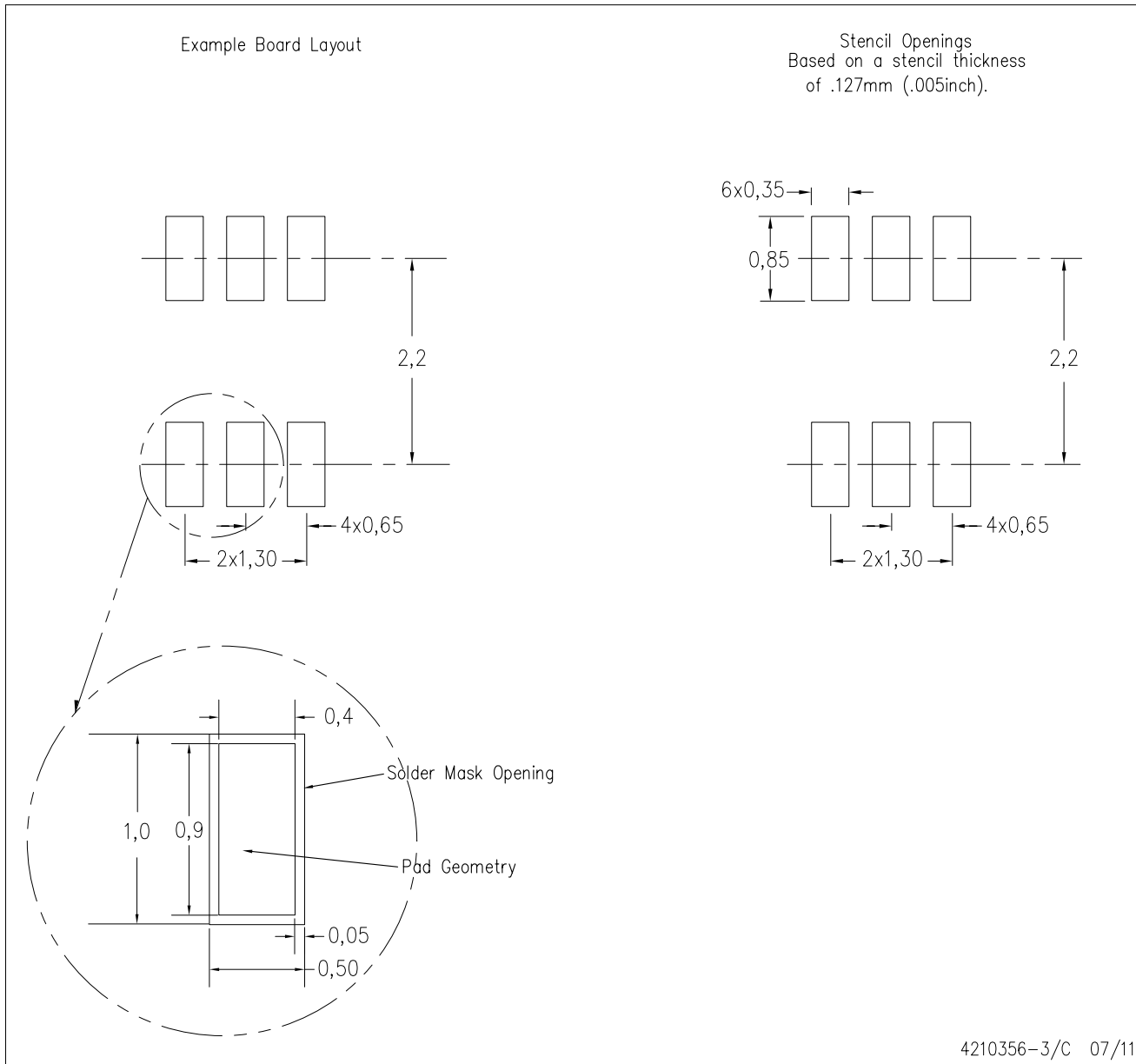

- NOTES:
- A. All linear dimensions are in millimeters.
  - B. This drawing is subject to change without notice.
  - C. Customers should place a note on the circuit board fabrication drawing not to alter the center solder mask defined pad.
  - D. Publication IPC-7351 is recommended for alternate designs.
  - E. Laser cutting apertures with trapezoidal walls and also rounding corners will offer better paste release. Customers should contact their board assembly site for stencil design recommendations. Example stencil design based on a 50% volumetric metal load solder paste. Refer to IPC-7525 for other stencil recommendations.



# EXAMPLE BOARD LAYOUT

D0008A

SOIC - 1.75 mm max height

SMALL OUTLINE INTEGRATED CIRCUIT



LAND PATTERN EXAMPLE  
 EXPOSED METAL SHOWN  
 SCALE:8X



SOLDER MASK DETAILS

4214825/C 02/2019

NOTES: (continued)

- 6. Publication IPC-7351 may have alternate designs.
- 7. Solder mask tolerances between and around signal pads can vary based on board fabrication site.

# EXAMPLE STENCIL DESIGN

D0008A

SOIC - 1.75 mm max height

SMALL OUTLINE INTEGRATED CIRCUIT



SOLDER PASTE EXAMPLE  
BASED ON .005 INCH [0.125 MM] THICK STENCIL  
SCALE:8X

4214825/C 02/2019

NOTES: (continued)

8. Laser cutting apertures with trapezoidal walls and rounded corners may offer better paste release. IPC-7525 may have alternate design recommendations.
9. Board assembly site may have different recommendations for stencil design.

DBV0005A



# PACKAGE OUTLINE

SOT-23 - 1.45 mm max height

SMALL OUTLINE TRANSISTOR

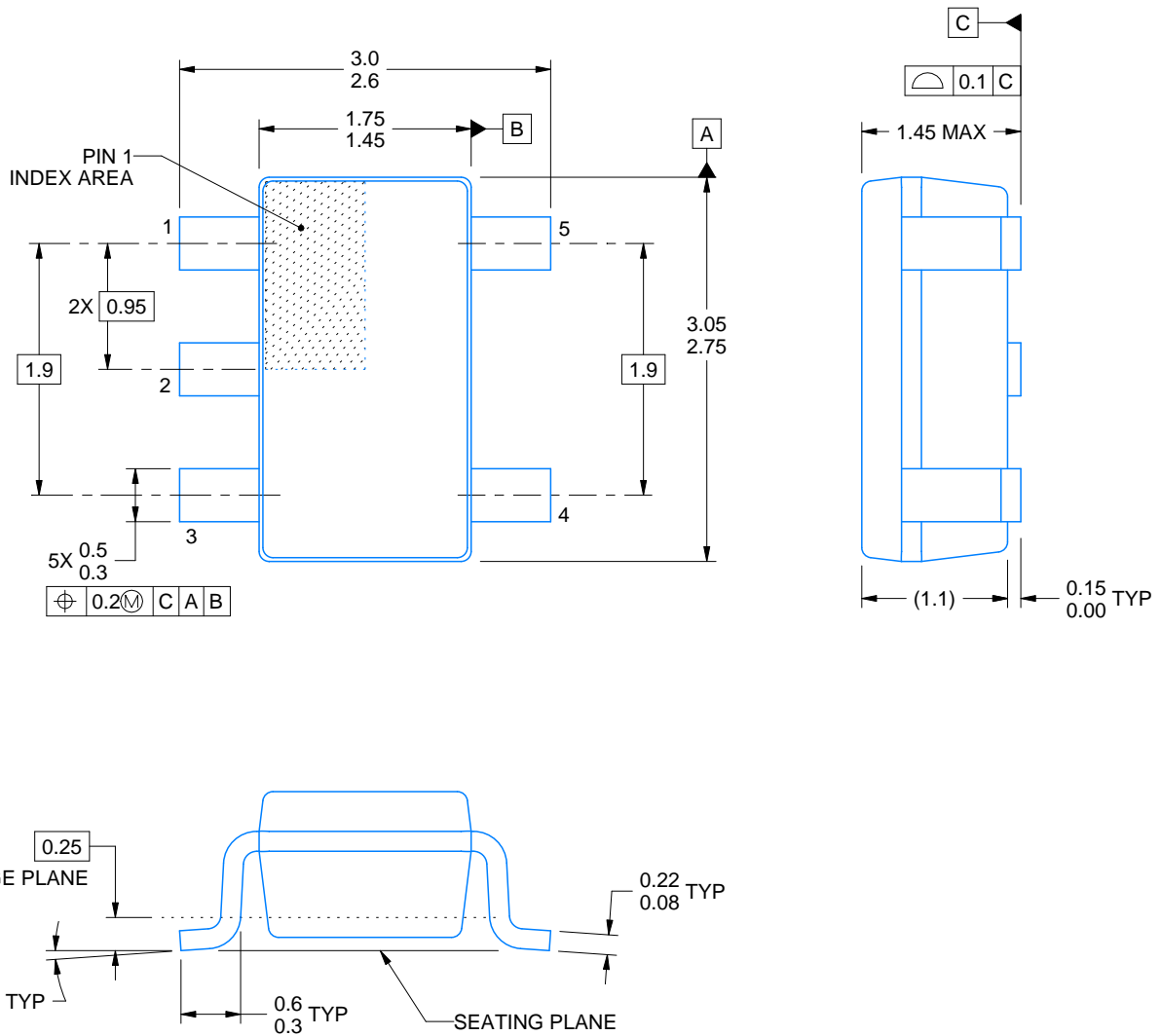

4214839/D 11/2018

NOTES:

1. All linear dimensions are in millimeters. Any dimensions in parenthesis are for reference only. Dimensioning and tolerancing per ASME Y14.5M.
2. This drawing is subject to change without notice.
3. Reference JEDEC MO-178.
4. Body dimensions do not include mold flash, protrusions, or gate burrs. Mold flash, protrusions, or gate burrs shall not exceed 0.15 mm per side.

# EXAMPLE BOARD LAYOUT

DBV0005A

SOT-23 - 1.45 mm max height

SMALL OUTLINE TRANSISTOR



LAND PATTERN EXAMPLE  
EXPOSED METAL SHOWN  
SCALE:15X



SOLDER MASK DETAILS

4214839/D 11/2018

NOTES: (continued)

- 5. Publication IPC-7351 may have alternate designs.
- 6. Solder mask tolerances between and around signal pads can vary based on board fabrication site.

# EXAMPLE STENCIL DESIGN

DBV0005A

SOT-23 - 1.45 mm max height

SMALL OUTLINE TRANSISTOR



SOLDER PASTE EXAMPLE  
BASED ON 0.125 mm THICK STENCIL  
SCALE:15X

4214839/D 11/2018

NOTES: (continued)

7. Laser cutting apertures with trapezoidal walls and rounded corners may offer better paste release. IPC-7525 may have alternate design recommendations.
8. Board assembly site may have different recommendations for stencil design.

## GENERIC PACKAGE VIEW

LP 3

TO-92 - 5.34 mm max height

TRANSISTOR OUTLINE



Images above are just a representation of the package family, actual package may vary.  
Refer to the product data sheet for package details.

4040001-2/F

LP0003A



# PACKAGE OUTLINE

TO-92 - 5.34 mm max height

TO-92



4215214/B 04/2017

## NOTES:

1. All linear dimensions are in millimeters. Any dimensions in parenthesis are for reference only. Dimensioning and tolerancing per ASME Y14.5M.
2. This drawing is subject to change without notice.
3. Lead dimensions are not controlled within this area.
4. Reference JEDEC TO-226, variation AA.
5. Shipping method:
  - a. Straight lead option available in bulk pack only.
  - b. Formed lead option available in tape and reel or ammo pack.
  - c. Specific products can be offered in limited combinations of shipping medium and lead options.
  - d. Consult product folder for more information on available options.



LAND PATTERN EXAMPLE  
STRAIGHT LEAD OPTION  
NON-SOLDER MASK DEFINED  
SCALE:15X



LAND PATTERN EXAMPLE  
FORMED LEAD OPTION  
NON-SOLDER MASK DEFINED  
SCALE:15X



## IMPORTANT NOTICE AND DISCLAIMER

TI PROVIDES TECHNICAL AND RELIABILITY DATA (INCLUDING DATASHEETS), DESIGN RESOURCES (INCLUDING REFERENCE DESIGNS), APPLICATION OR OTHER DESIGN ADVICE, WEB TOOLS, SAFETY INFORMATION, AND OTHER RESOURCES "AS IS" AND WITH ALL FAULTS, AND DISCLAIMS ALL WARRANTIES, EXPRESS AND IMPLIED, INCLUDING WITHOUT LIMITATION ANY IMPLIED WARRANTIES OF MERCHANTABILITY, FITNESS FOR A PARTICULAR PURPOSE OR NON-INFRINGEMENT OF THIRD PARTY INTELLECTUAL PROPERTY RIGHTS.

These resources are intended for skilled developers designing with TI products. You are solely responsible for (1) selecting the appropriate TI products for your application, (2) designing, validating and testing your application, and (3) ensuring your application meets applicable standards, and any other safety, security, or other requirements. These resources are subject to change without notice. TI grants you permission to use these resources only for development of an application that uses the TI products described in the resource. Other reproduction and display of these resources is prohibited. No license is granted to any other TI intellectual property right or to any third party intellectual property right. TI disclaims responsibility for, and you will fully indemnify TI and its representatives against, any claims, damages, costs, losses, and liabilities arising out of your use of these resources.

TI's products are provided subject to TI's Terms of Sale ([www.ti.com/legal/termsofsale.html](http://www.ti.com/legal/termsofsale.html)) or other applicable terms available either on [ti.com](http://ti.com) or provided in conjunction with such TI products. TI's provision of these resources does not expand or otherwise alter TI's applicable warranties or warranty disclaimers for TI products.

Mailing Address: Texas Instruments, Post Office Box 655303, Dallas, Texas 75265  
Copyright © 2019, Texas Instruments Incorporated

## Looking for pricing, stock, or lifecycle information?

Click below to explore more details on WIN SOURCE:

 [View TLV431BIPK on WIN SOURCE](#)

 [Texas Instruments](#) Information

## Optimize Your Supply Chain with WIN SOURCE Solutions

-  Global Sourcing Solution
-  Obsolete Management
-  Cost Control Management
-  Shortage Management
-  Alternative Solution
-  Excess Inventory Management