

NTD4856N, NVD4856N

Power MOSFET

25 V, 89 A, Single N-Channel, DPAK/IPAK



ON Semiconductor®

www.onsemi.com

Features

- Trench Technology
- Low $R_{DS(on)}$ to Minimize Conduction Losses
- Low Capacitance to Minimize Driver Losses
- Optimized Gate Charge to Minimize Switching Losses
- NVD Prefix for Automotive and Other Applications Requiring Unique Site and Control Change Requirements; AEC-Q101 Qualified and PPAP Capable
- These Devices are Pb-Free and are RoHS Compliant

Applications

- VCore Applications
- DC-DC Converters
- Low Side Switching

$V_{(BR)DSS}$	$R_{DS(on)}$ MAX	I_D MAX
25 V	4.7 mΩ @ 10 V	89 A
	6.8 mΩ @ 4.5 V	

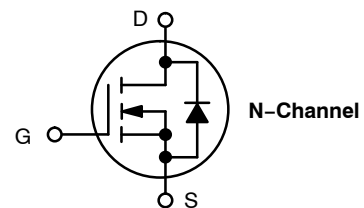

MAXIMUM RATINGS ($T_J = 25^\circ\text{C}$ unless otherwise stated)

Parameter	Symbol	Value	Unit		
Drain-to-Source Voltage	V_{DSS}	25	V		
Gate-to-Source Voltage	V_{GS}	± 20	V		
Continuous Drain Current $R_{\theta JA}$ (Note 1)	I_D	$T_A = 25^\circ\text{C}$	16.8	A	
		$T_A = 85^\circ\text{C}$	13.0		
Power Dissipation $R_{\theta JA}$ (Note 1)	P_D	$T_A = 25^\circ\text{C}$	2.14	W	
		$T_A = 85^\circ\text{C}$			
Continuous Drain Current $R_{\theta JA}$ (Note 2)	I_D	$T_A = 25^\circ\text{C}$	13.3	A	
		$T_A = 85^\circ\text{C}$	10.3		
Power Dissipation $R_{\theta JA}$ (Note 2)	P_D	$T_A = 25^\circ\text{C}$	1.33	W	
		$T_C = 25^\circ\text{C}$			
Continuous Drain Current $R_{\theta JC}$ (Note 1)	I_D	$T_C = 25^\circ\text{C}$	89	A	
		$T_C = 85^\circ\text{C}$	69		
Power Dissipation $R_{\theta JC}$ (Note 1)	P_D	$T_C = 25^\circ\text{C}$	60	W	
		$T_C = 85^\circ\text{C}$			
Pulsed Drain Current	$t_p = 10\mu\text{s}$	$T_A = 25^\circ\text{C}$	I_{DM}	179	A
Current Limited by Package		$T_A = 25^\circ\text{C}$	$I_{DmaxPkg}$	45	A
Operating Junction and Storage Temperature	T_J, T_{STG}	-55 to +175			$^\circ\text{C}$
Source Current (Body Diode)	I_S	50			A
Drain to Source dV/dt	dV/dt	6			V/ns
Single Pulse Drain-to-Source Avalanche Energy ($T_J = 25^\circ\text{C}, V_{DD} = 50\text{ V}, V_{GS} = 10\text{ V}, I_L = 19\text{ A}_{pk}, L = 1.0\text{ mH}, R_G = 25\ \Omega$)	EAS	180.5			mJ
Lead Temperature for Soldering Purposes (1/8" from case for 10 s)	T_L	260			$^\circ\text{C}$

Stresses exceeding those listed in the Maximum Ratings table may damage the device. If any of these limits are exceeded, device functionality should not be assumed, damage may occur and reliability may be affected.

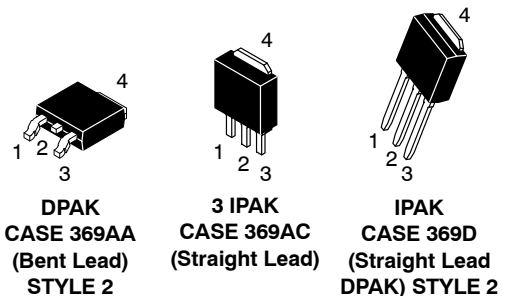

MARKING DIAGRAMS & PIN ASSIGNMENTS

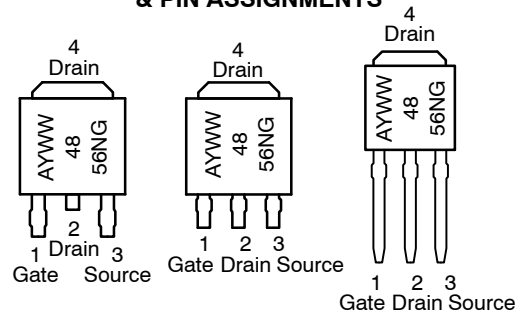

- A = Assembly Location*
- Y = Year
- WW = Work Week
- 4856N = Device Code
- G = Pb-Free Package

* The Assembly Location Code (A) is front side optional. In cases where the Assembly Location is stamped in the package bottom (molding ejecter pin), the front side assembly code may be blank.

ORDERING INFORMATION

See detailed ordering and shipping information in the package dimensions section on page 6 of this data sheet.

NTD4856N, NVD4856N

THERMAL RESISTANCE MAXIMUM RATINGS

Parameter	Symbol	Value	Unit
Junction-to-Case (Drain)	$R_{\theta JC}$	2.5	°C/W
Junction-to-TAB (Drain)	$R_{\theta JC-TAB}$	3.5	
Junction-to-Ambient – Steady State (Note 1)	$R_{\theta JA}$	70	
Junction-to-Ambient – Steady State (Note 2)	$R_{\theta JA}$	113	

1. Surface-mounted on FR4 board using 1 sq-in pad, 1 oz Cu.
2. Surface-mounted on FR4 board using the minimum recommended pad size.

ELECTRICAL CHARACTERISTICS ($T_J = 25^\circ\text{C}$ unless otherwise specified)

Parameter	Symbol	Test Condition	Min	Typ	Max	Unit
-----------	--------	----------------	-----	-----	-----	------

OFF CHARACTERISTICS

Drain-to-Source Breakdown Voltage	$V_{(BR)DSS}$	$V_{GS} = 0\text{ V}, I_D = 250\ \mu\text{A}$	25			V
Drain-to-Source Breakdown Voltage Temperature Coefficient	$V_{(BR)DSS}/T_J$			23		mV/°C
Zero Gate Voltage Drain Current	I_{DSS}	$V_{GS} = 0\text{ V}, V_{DS} = 20\text{ V}$	$T_J = 25^\circ\text{C}$		1.0	μA
			$T_J = 125^\circ\text{C}$		10	
Gate-to-Source Leakage Current	I_{GSS}	$V_{DS} = 0\text{ V}, V_{GS} = \pm 20\text{ V}$			± 100	nA

ON CHARACTERISTICS (Note 3)

Gate Threshold Voltage	$V_{GS(TH)}$	$V_{GS} = V_{DS}, I_D = 250\ \mu\text{A}$	1.45		2.5	V	
Negative Threshold Temperature Coefficient	$V_{GS(TH)}/T_J$			5.9		mV/°C	
Drain-to-Source On Resistance	$R_{DS(on)}$	$V_{GS} = 10\text{ V}$	$I_D = 30\text{ A}$		3.9	4.7	m Ω
		$V_{GS} = 4.5\text{ V}$	$I_D = 30\text{ A}$		5.3	6.8	
Forward Transconductance	g_{FS}	$V_{DS} = 1.5\text{ V}, I_D = 15\text{ A}$		73		S	

CHARGES AND CAPACITANCES

Input Capacitance	C_{ISS}	$V_{GS} = 0\text{ V}, f = 1.0\text{ MHz}, V_{DS} = 12\text{ V}$		2241		pF
Output Capacitance	C_{OSS}			567		
Reverse Transfer Capacitance	C_{RSS}			279		
Total Gate Charge	$Q_{G(TOT)}$	$V_{GS} = 4.5\text{ V}, V_{DS} = 15\text{ V}, I_D = 30\text{ A}$		18	27	nC
Threshold Gate Charge	$Q_{G(TH)}$			3.4		
Gate-to-Source Charge	Q_{GS}			6.7		
Gate-to-Drain Charge	Q_{GD}			6.6		
Total Gate Charge	$Q_{G(TOT)}$	$V_{GS} = 10\text{ V}, V_{DS} = 15\text{ V}, I_D = 30\text{ A}$		38		nC

SWITCHING CHARACTERISTICS (Note 4)

Turn-On Delay Time	$t_{d(ON)}$	$V_{GS} = 4.5\text{ V}, V_{DS} = 15\text{ V}, I_D = 15\text{ A}, R_G = 3.0\ \Omega$		15.7		ns
Rise Time	t_r			22.5		
Turn-Off Delay Time	$t_{d(OFF)}$			18.6		
Fall Time	t_f			7.5		

Product parametric performance is indicated in the Electrical Characteristics for the listed test conditions, unless otherwise noted. Product performance may not be indicated by the Electrical Characteristics if operated under different conditions.

3. Pulse Test: pulse width $\leq 300\ \mu\text{s}$, duty cycle $\leq 2\%$.
4. Switching characteristics are independent of operating junction temperatures.

NTD4856N, NVD4856N

ELECTRICAL CHARACTERISTICS ($T_J = 25^\circ\text{C}$ unless otherwise specified) (continued)

Parameter	Symbol	Test Condition	Min	Typ	Max	Unit
SWITCHING CHARACTERISTICS (Note 4)						
Turn-On Delay Time	$t_{d(ON)}$	$V_{GS} = 11.5\text{ V}, V_{DS} = 15\text{ V},$ $I_D = 15\text{ A}, R_G = 3.0\ \Omega$		8.7		ns
Rise Time	t_r			17.5		
Turn-Off Delay Time	$t_{d(OFF)}$			27.2		
Fall Time	t_f			4.0		

DRAIN-SOURCE DIODE CHARACTERISTICS

Forward Diode Voltage	V_{SD}	$V_{GS} = 0\text{ V},$ $I_S = 30\text{ A}$	$T_J = 25^\circ\text{C}$		0.87	1.2	V
			$T_J = 125^\circ\text{C}$		0.72		
Reverse Recovery Time	t_{RR}	$V_{GS} = 0\text{ V}, dI_S/dt = 100\text{ A}/\mu\text{s},$ $I_S = 30\text{ A}$		18.7		ns	
Charge Time	t_a			9.3			
Discharge Time	t_b			9.4			
Reverse Recovery Charge	Q_{RR}			8.0		nC	

PACKAGE PARASITIC VALUES

Source Inductance	L_S	$T_A = 25^\circ\text{C}$		2.49		nH
Drain Inductance, DPAK	L_D			0.0164		
Drain Inductance, IPAK	L_D			1.88		
Gate Inductance	L_G			3.46		
Gate Resistance	R_G			0.6		

Product parametric performance is indicated in the Electrical Characteristics for the listed test conditions, unless otherwise noted. Product performance may not be indicated by the Electrical Characteristics if operated under different conditions.

3. Pulse Test: pulse width $\leq 300\ \mu\text{s}$, duty cycle $\leq 2\%$.

4. Switching characteristics are independent of operating junction temperatures.

NTD4856N, NVD4856N

TYPICAL PERFORMANCE CURVES

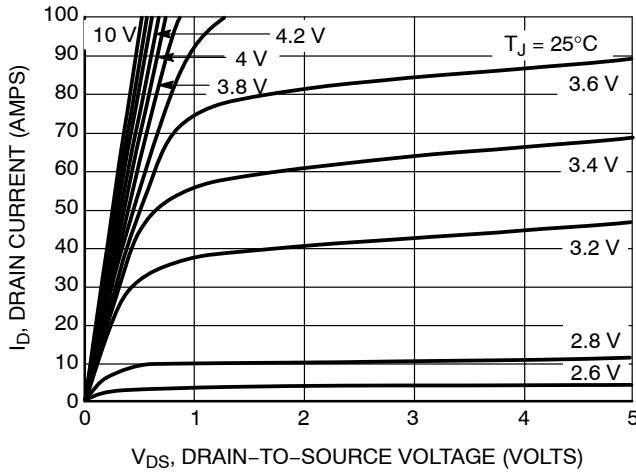

Figure 1. On-Region Characteristics

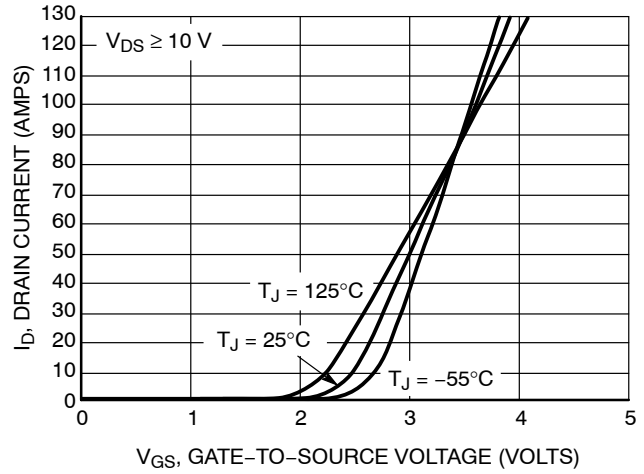

Figure 2. Transfer Characteristics

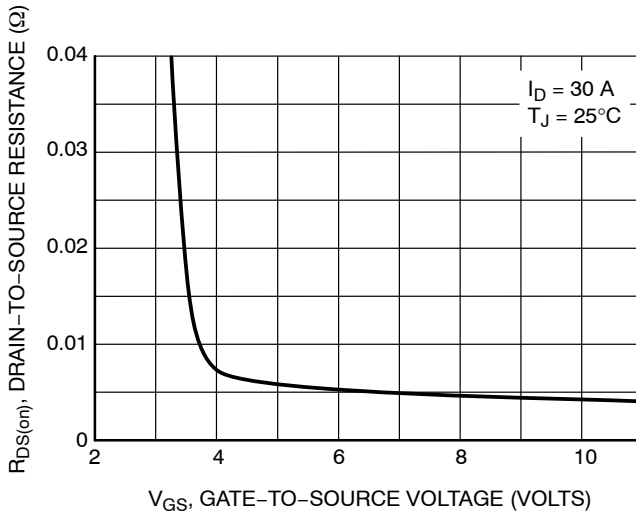

Figure 3. On-Resistance vs. Gate-to-Source Voltage

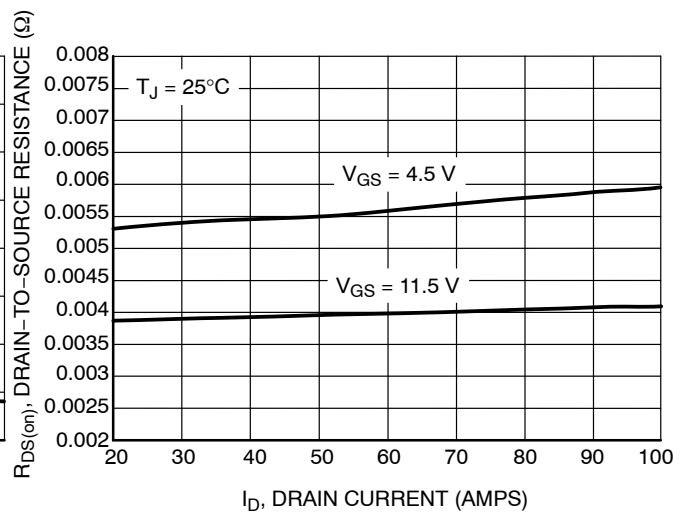

Figure 4. On-Resistance vs. Drain Current and Gate Voltage

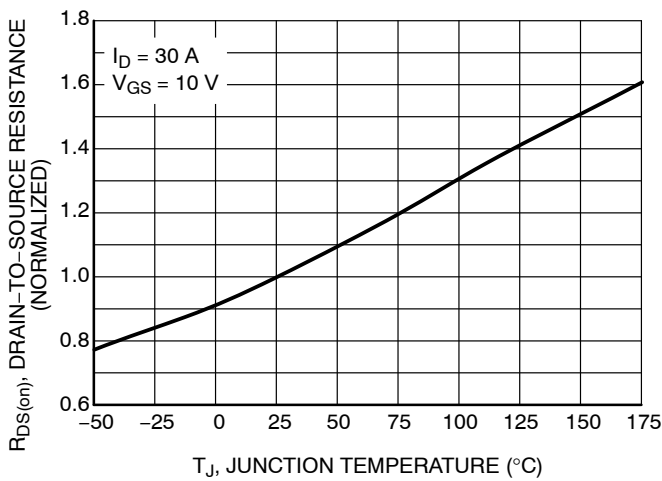

Figure 5. On-Resistance Variation with Temperature

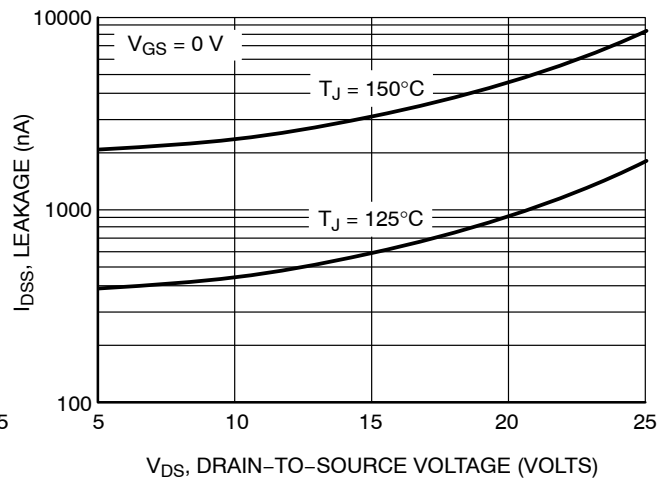

Figure 6. Drain-to-Source Leakage Current vs. Drain Voltage

NTD4856N, NVD4856N

TYPICAL PERFORMANCE CURVES

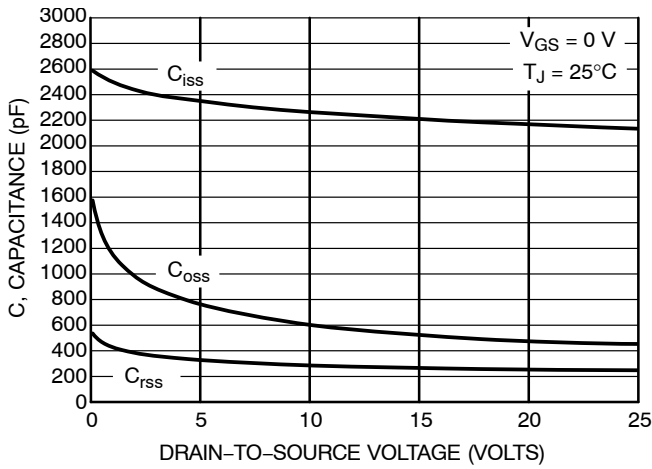

Figure 7. Capacitance Variation

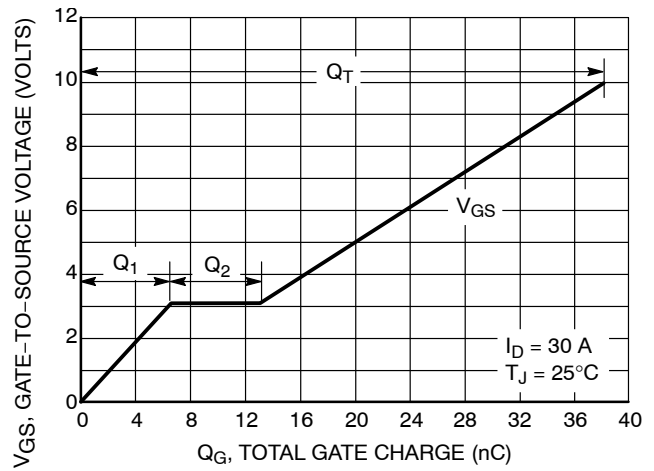

Figure 8. Gate-To-Source and Drain-To-Source Voltage vs. Total Charge

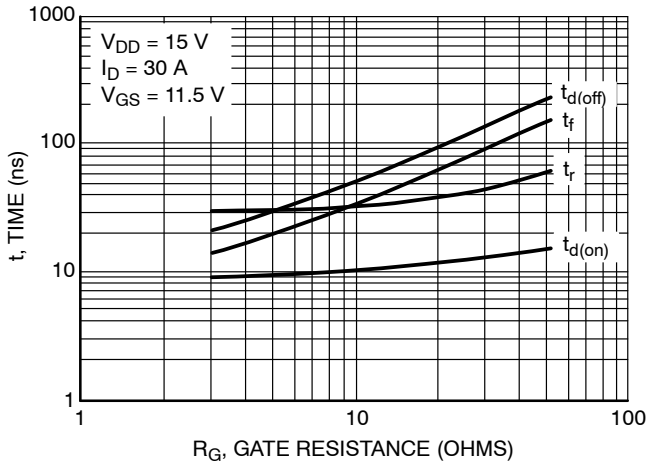

Figure 9. Resistive Switching Time Variation vs. Gate Resistance

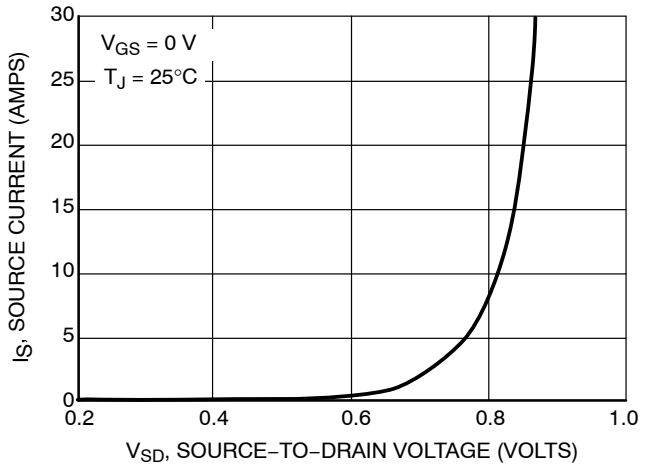

Figure 10. Diode Forward Voltage vs. Current

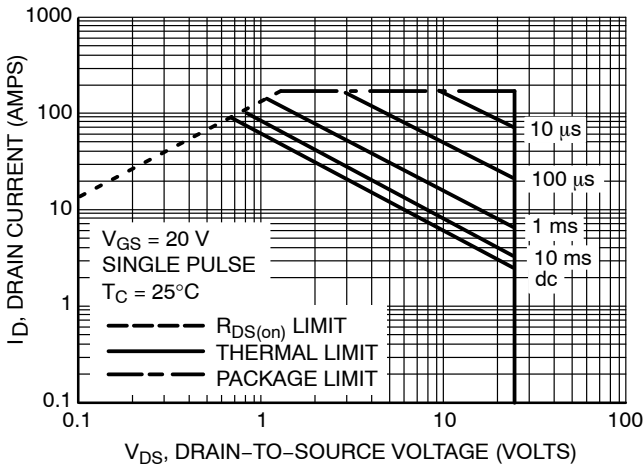

Figure 11. Maximum Rated Forward Biased Safe Operating Area

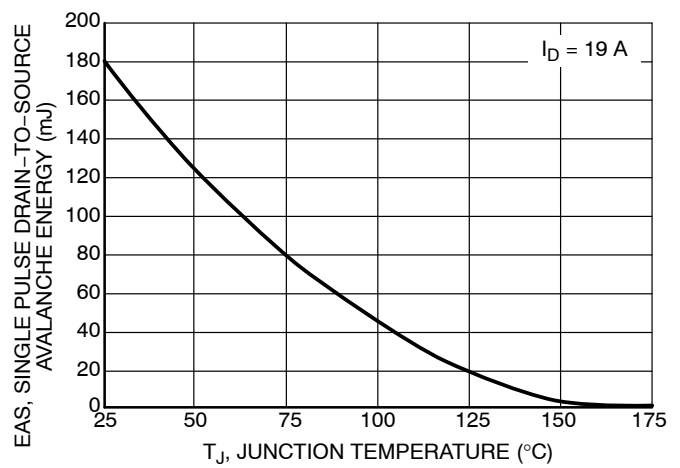

Figure 12. Maximum Avalanche Energy vs. Starting Junction Temperature

NTD4856N, NVD4856N

TYPICAL PERFORMANCE CURVES

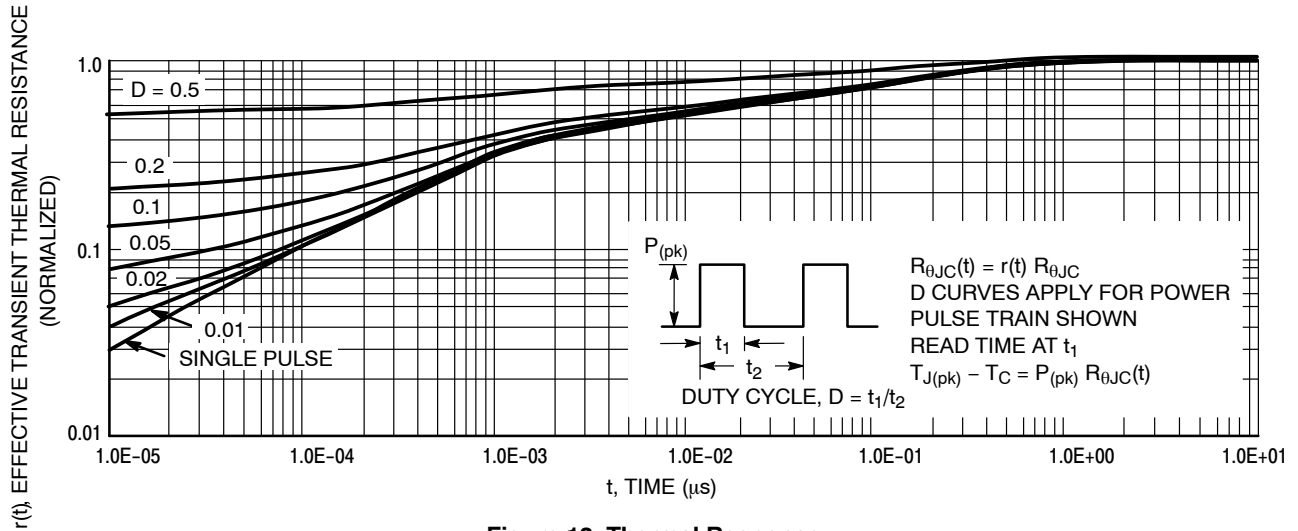

Figure 13. Thermal Response

ORDERING INFORMATION

Device	Package	Shipping†
NTD4856NT4G	DPAK (Pb-Free)	2500 / Tape & Reel
NTD4856N-1G	IPAK (Pb-Free)	75 Units / Rail
NTD4856N-35G	IPAK Trimmed Lead (3.5 ± 0.15 mm) (Pb-Free)	75 Units / Rail
NVD4856NT4G*	DPAK (Pb-Free)	2500 / Tape & Reel
NVD4856NT4G-VF01	DPAK (Pb-Free)	2500 / Tape & Reel

†For information on tape and reel specifications, including part orientation and tape sizes, please refer to our Tape and Reel Packaging Specifications Brochure, BRD8011/D.

*NVD Prefix for Automotive and Other Applications Requiring Unique Site and Control Change Requirements; AEC-Q101 Qualified and PPAP Capable.

NTD4856N, NVD4856N

PACKAGE DIMENSIONS

DPAK (SINGLE GUAGE) CASE 369AA ISSUE B

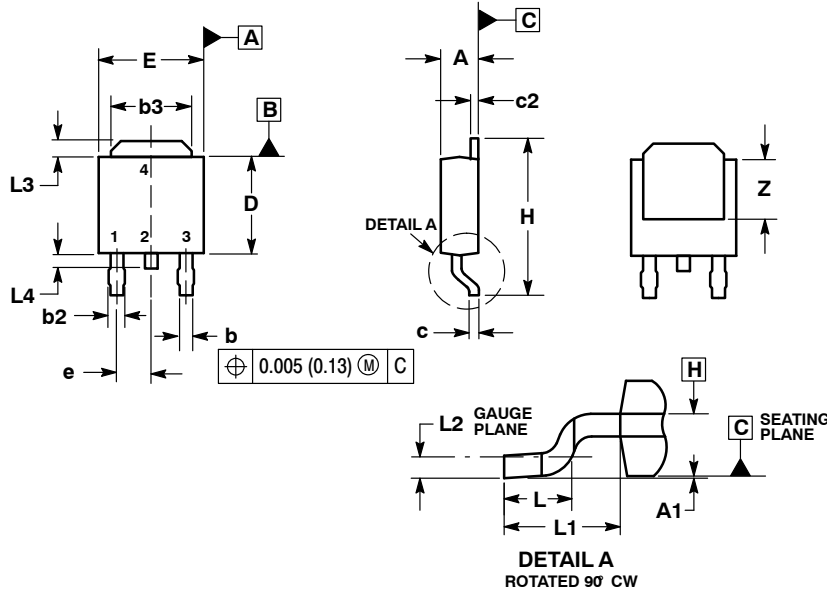

NOTES:

1. DIMENSIONING AND TOLERANCING PER ASME Y14.5M, 1994.
2. CONTROLLING DIMENSION: INCHES.
3. THERMAL PAD CONTOUR OPTIONAL WITHIN DIMENSIONS b3, L3 and Z.
4. DIMENSIONS D AND E DO NOT INCLUDE MOLD FLASH, PROTRUSIONS, OR BURRS. MOLD FLASH, PROTRUSIONS, OR GATE BURRS SHALL NOT EXCEED 0.006 INCHES PER SIDE.
5. DIMENSIONS D AND E ARE DETERMINED AT THE OUTERMOST EXTREMES OF THE PLASTIC BODY.
6. DATUMS A AND B ARE DETERMINED AT DATUM PLANE H.

DIM	INCHES		MILLIMETERS	
	MIN	MAX	MIN	MAX
A	0.086	0.094	2.18	2.38
A1	0.000	0.005	0.00	0.13
b	0.025	0.035	0.63	0.89
b2	0.030	0.045	0.76	1.14
b3	0.180	0.215	4.57	5.46
c	0.018	0.024	0.46	0.61
c2	0.018	0.024	0.46	0.61
D	0.235	0.245	5.97	6.22
E	0.250	0.265	6.35	6.73
e	0.090	BSC	2.29	BSC
H	0.370	0.410	9.40	10.41
L	0.055	0.070	1.40	1.78
L1	0.108	REF	2.74	REF
L2	0.020	BSC	0.51	BSC
L3	0.035	0.050	0.89	1.27
L4	---	0.040	---	1.01
Z	0.155	---	3.93	---

SOLDERING FOOTPRINT*

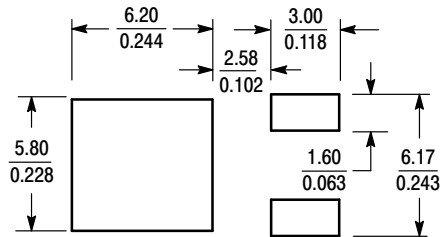

SCALE 3:1 $\left(\frac{\text{mm}}{\text{inches}}\right)$

STYLE 2:

- PIN 1. GATE
- DRAIN
- SOURCE
- DRAIN

*For additional information on our Pb-Free strategy and soldering details, please download the ON Semiconductor Soldering and Mounting Techniques Reference Manual, SOLDERRM/D.

NTD4856N, NVD4856N

PACKAGE DIMENSIONS

3 IPAK, STRAIGHT LEAD CASE 369AC ISSUE O

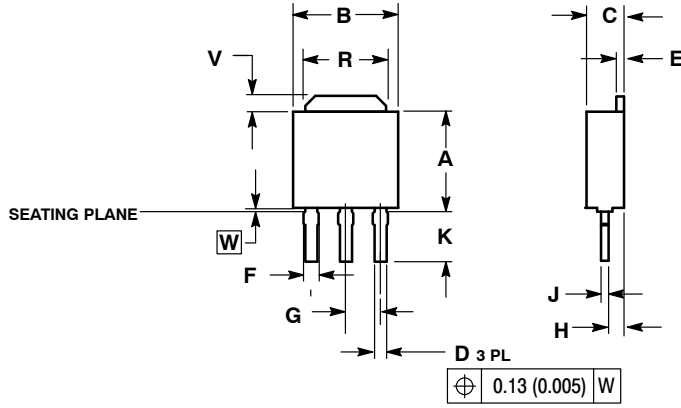

NOTES:

- 1.. DIMENSIONING AND TOLERANCING PER ANSI Y14.5M, 1982.
- 2.. CONTROLLING DIMENSION: INCH.
3. SEATING PLANE IS ON TOP OF DAMBAR POSITION.
4. DIMENSION A DOES NOT INCLUDE DAMBAR POSITION OR MOLD GATE.

DIM	INCHES		MILLIMETERS	
	MIN	MAX	MIN	MAX
A	0.235	0.245	5.97	6.22
B	0.250	0.265	6.35	6.73
C	0.086	0.094	2.19	2.38
D	0.027	0.035	0.69	0.88
E	0.018	0.023	0.46	0.58
F	0.037	0.043	0.94	1.09
G	0.090 BSC		2.29 BSC	
H	0.034	0.040	0.87	1.01
J	0.018	0.023	0.46	0.58
K	0.134	0.142	3.40	3.60
R	0.180	0.215	4.57	5.46
V	0.035	0.050	0.89	1.27
W	0.000	0.010	0.000	0.25

IPAK CASE 369D ISSUE C

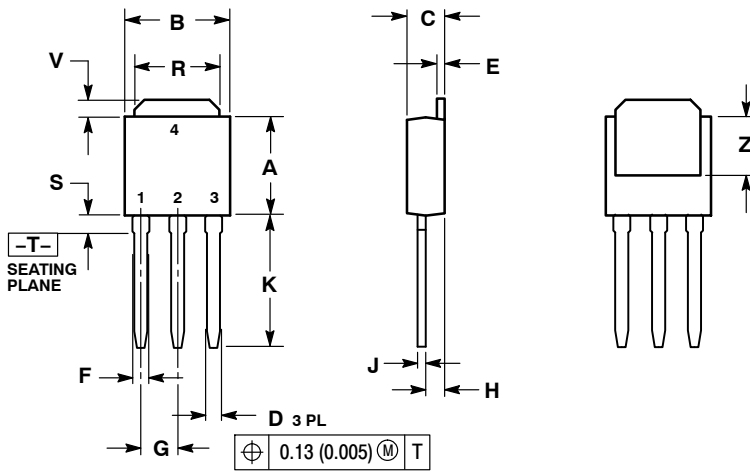

NOTES:

1. DIMENSIONING AND TOLERANCING PER ANSI Y14.5M, 1982.
2. CONTROLLING DIMENSION: INCH.

DIM	INCHES		MILLIMETERS	
	MIN	MAX	MIN	MAX
A	0.235	0.245	5.97	6.35
B	0.250	0.265	6.35	6.73
C	0.086	0.094	2.19	2.38
D	0.027	0.035	0.69	0.88
E	0.018	0.023	0.46	0.58
F	0.037	0.045	0.94	1.14
G	0.090 BSC		2.29 BSC	
H	0.034	0.040	0.87	1.01
J	0.018	0.023	0.46	0.58
K	0.350	0.380	8.89	9.65
R	0.180	0.215	4.45	5.45
S	0.025	0.040	0.63	1.01
V	0.035	0.050	0.89	1.27
Z	0.155	---	3.93	---

STYLE 2:

- PIN 1. GATE
- DRAIN
- SOURCE
- DRAIN

ON Semiconductor and are trademarks of Semiconductor Components Industries, LLC dba ON Semiconductor or its subsidiaries in the United States and/or other countries. ON Semiconductor owns the rights to a number of patents, trademarks, copyrights, trade secrets, and other intellectual property. A listing of ON Semiconductor's product/patent coverage may be accessed at www.onsemi.com/site/pdf/Patent-Marking.pdf. ON Semiconductor reserves the right to make changes without further notice to any products herein. ON Semiconductor makes no warranty, representation or guarantee regarding the suitability of its products for any particular purpose, nor does ON Semiconductor assume any liability arising out of the application or use of any product or circuit, and specifically disclaims any and all liability, including without limitation special, consequential or incidental damages. Buyer is responsible for its products and applications using ON Semiconductor products, including compliance with all laws, regulations and safety requirements or standards, regardless of any support or applications information provided by ON Semiconductor. "Typical" parameters which may be provided in ON Semiconductor data sheets and/or specifications can and do vary in different applications and actual performance may vary over time. All operating parameters, including "Typicals" must be validated for each customer application by customer's technical experts. ON Semiconductor does not convey any license under its patent rights nor the rights of others. ON Semiconductor products are not designed, intended, or authorized for use as a critical component in life support systems or any FDA Class 3 medical devices or medical devices with a same or similar classification in a foreign jurisdiction or any devices intended for implantation in the human body. Should Buyer purchase or use ON Semiconductor products for any such unintended or unauthorized application, Buyer shall indemnify and hold ON Semiconductor and its officers, employees, subsidiaries, affiliates, and distributors harmless against all claims, costs, damages, and expenses, and reasonable attorney fees arising out of, directly or indirectly, any claim of personal injury or death associated with such unintended or unauthorized use, even if such claim alleges that ON Semiconductor was negligent regarding the design or manufacture of the part. ON Semiconductor is an Equal Opportunity/Affirmative Action Employer. This literature is subject to all applicable copyright laws and is not for resale in any manner.

PUBLICATION ORDERING INFORMATION

LITERATURE FULFILLMENT:

Literature Distribution Center for ON Semiconductor
19521 E. 32nd Pkwy, Aurora, Colorado 80011 USA
Phone: 303-675-2175 or 800-344-3860 Toll Free USA/Canada
Fax: 303-675-2176 or 800-344-3867 Toll Free USA/Canada
Email: orderlit@onsemi.com

N. American Technical Support: 800-282-9855 Toll Free
USA/Canada
Europe, Middle East and Africa Technical Support:
Phone: 421 33 790 2910
Japan Customer Focus Center
Phone: 81-3-5817-1050

ON Semiconductor Website: www.onsemi.com
Order Literature: <http://www.onsemi.com/orderlit>

For additional information, please contact your local Sales Representative

Looking for pricing, stock, or lifecycle information?

Click below to explore more details on WIN SOURCE:

 [View NVD4856NT4G-VF01 on WIN SOURCE](#)

 [ON Semiconductor](#) Information

Optimize Your Supply Chain with WIN SOURCE Solutions

-  Global Sourcing Solution
-  Obsolete Management
-  Cost Control Management
-  Shortage Management
-  Alternative Solution
-  Excess Inventory Management