



**THE DATASHEET OF
LQP03HQ4N7H02D**



Customer Part Number	MURATA Part Number	Inductance		Q (min)	DC Resistance (Ω max)	Self Resonant Frequency (MHz)		Rated Current (mA)
		(nH)	Tolerance			Min.	*Typ	
	LQP03HQ4N3H02D	4.3	H: \pm 3% J: \pm 5%	20	0.17	7000	9500	500
	LQP03HQ4N3J02D							
	LQP03HQ4N7H02D	4.7			0.25	5500	7700	400
	LQP03HQ4N7J02D							
	LQP03HQ4N8H02D	4.8			0.3	4500	6400	300
	LQP03HQ4N8J02D							
	LQP03HQ4N9H02D	4.9			0.4	4000	5200	250
	LQP03HQ4N9J02D							
	LQP03HQ5N0H02D	5.0			0.5	3500	4200	170
	LQP03HQ5N0J02D							
	LQP03HQ5N1H02D	5.1	0.7	3000	3950	150		
	LQP03HQ5N1J02D							
	LQP03HQ5N6H02D	5.6	0.8	2000	2900	130		
	LQP03HQ5N6J02D							
	LQP03HQ6N2H02D	6.2	0.82	1700	2700	150		
	LQP03HQ6N2J02D							
	LQP03HQ6N8H02D	6.8	0.8	1500	2400	150		
	LQP03HQ6N8J02D							
	LQP03HQ7N5H02D	7.5	0.8	1300	2200	130		
	LQP03HQ7N5J02D							
	LQP03HQ8N2H02D	8.2	0.8	1100	2000	130		
	LQP03HQ8N2J02D							
	LQP03HQ9N1H02D	9.1	0.8	1000	1900	130		
	LQP03HQ9N1J02D							
	LQP03HQ10NH02D	10	0.8	900	1800	130		
	LQP03HQ10NJ02D							
	LQP03HQ11NH02D	11	0.8	800	1700	130		
	LQP03HQ11NJ02D							
	LQP03HQ12NH02D	12	0.8	700	1600	130		
	LQP03HQ12NJ02D							
	LQP03HQ13NH02D	13	0.8	600	1500	130		
	LQP03HQ13NJ02D							
	LQP03HQ15NH02D	15	0.8	500	1400	130		
	LQP03HQ15NJ02D							
	LQP03HQ16NH02D	16	0.8	400	1300	130		
	LQP03HQ16NJ02D							
	LQP03HQ18NH02D	18	0.8	300	1200	130		
	LQP03HQ18NJ02D							
	LQP03HQ20NH02D	20	0.8	200	1100	130		
	LQP03HQ20NJ02D							
	LQP03HQ22NH02D	22	0.8	150	1000	130		
	LQP03HQ22NJ02D							
	LQP03HQ24NH02D	24	0.8	100	900	130		
	LQP03HQ24NJ02D							
	LQP03HQ27NH02D	27	0.8	80	800	130		
	LQP03HQ27NJ02D							
	LQP03HQ30NH02D	30	0.8	60	700	130		
	LQP03HQ30NJ02D							
	LQP03HQ33NH02D	33	0.8	50	600	130		
	LQP03HQ33NJ02D							
	LQP03HQ36NH02D	36	0.8	40	500	130		
	LQP03HQ36NJ02D							
	LQP03HQ39NH02D	39	0.8	30	400	130		
	LQP03HQ39NJ02D							
	LQP03HQ43NH02D	43	0.8	20	300	130		
	LQP03HQ43NJ02D							

Customer Part Number	MURATA Part Number	Inductance		Q (min)	DC Resistance (Ω max)	Self Resonant Frequency (MHz)		Rated Current (mA)			
		(nH)	Tolerance			Min.	*Typ				
	LQP03HQ47NH02D	47	H: $\pm 3\%$ J: $\pm 5\%$	12	2.5	1300	2000	130			
	LQP03HQ47NJ02D										
	LQP03HQ51NH02D	51				1200	5.0		1100	1800	100
	LQP03HQ51NJ02D										
	LQP03HQ56NH02D	56				62	7.0		1000	1500	80
	LQP03HQ56NJ02D										
	LQP03HQ62NH02D	62				75	8.0		900	1400	75
	LQP03HQ62NJ02D										
	LQP03HQ68NH02D	68				82	9.0		800	1300	65
	LQP03HQ68NJ02D										
	LQP03HQ75NH02D	75		91	10	700	1100	60			
	LQP03HQ75NJ02D										
	LQP03HQ82NH02D	82		100	7	650	900	50			
	LQP03HQ82NJ02D										
	LQP03HQ91NH02D	91		110	9	600	800	50			
	LQP03HQ91NJ02D										
	LQP03HQR10H02D	100		120	8	550	700	50			
	LQP03HQR10J02D										
	LQP03HQR11H02D	110		130	9	500	650	50			
	LQP03HQR11J02D										
	LQP03HQR12H02D	120	150	7	450	600	50				
	LQP03HQR12J02D										
	LQP03HQR13H02D	130	160	9	400	550	50				
	LQP03HQR13J02D										
	LQP03HQR15H02D	150	180	8	350	600	50				
	LQP03HQR15J02D										
	LQP03HQR16H02D	160	200	9	300	650	50				
	LQP03HQR16J02D										
	LQP03HQR18H02D	180	220	8	250	700	50				
	LQP03HQR18J02D										
	LQP03HQR20H02D	200	240	9	200	750	50				
	LQP03HQR20J02D										
	LQP03HQR22H02D	220	270	8	150	800	50				
	LQP03HQR22J02D										
	LQP03HQR24H02D	240	300	9	100	850	50				
	LQP03HQR24J02D										
	LQP03HQR27H02D	270	330	8	75	900	50				
	LQP03HQR27J02D										
	LQP03HQR30H02D	300	360	9	50	950	50				
	LQP03HQR30J02D										
	LQP03HQR33H02D	330	390	8	35	1000	50				
	LQP03HQR33J02D										
	LQP03HQR36H02D	360	430	9	25	1050	50				
	LQP03HQR36J02D										
	LQP03HQR39H02D	390	470	8	15	1100	50				
	LQP03HQR39J02D										
	LQP03HQR43H02D	430	470	9	10	1150	50				
	LQP03HQR43J02D										
	LQP03HQR47H02D	470	470	8	5	1200	50				
	LQP03HQR47J02D										

* Typical value is actual performance.

4. Testing Conditions

《Unless otherwise specified》

Temperature : Ordinary Temperature / 15°C to 35°C
Humidity : Ordinary Humidity / 25%(RH) to 85 %(RH)

《In case of doubt》

Temperature : 20°C \pm 2°C
Humidity : 60%(RH) to 70 %(RH)
Atmospheric Pressure : 86kPa to 106 kPa

5. Appearance and Dimensions

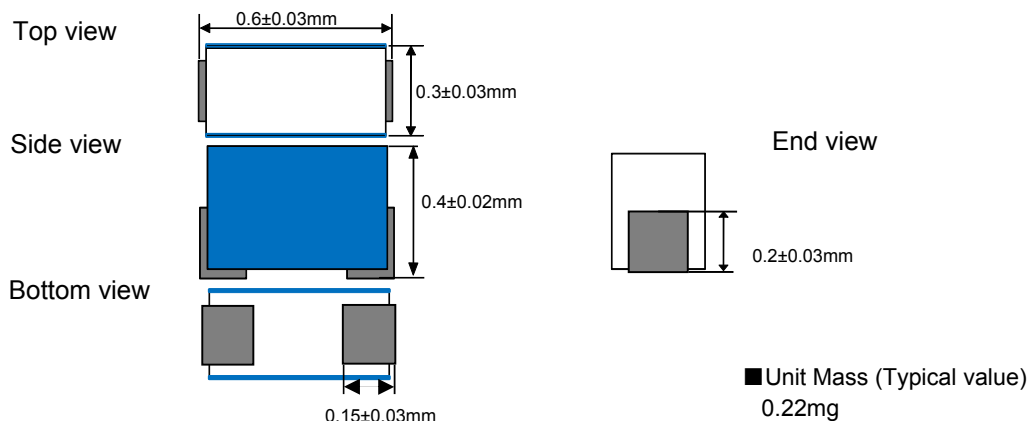

6. Marking

Side distinguishing marking : Blue

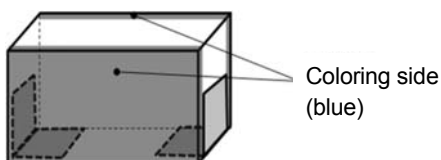

7. Electrical Performance

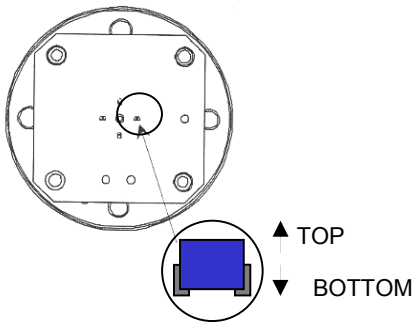
No.	Item	Specification	Test Method
7.1	Inductance	Inductance shall meet item 3.	Measuring Equipment: KEYSIGHT E4991A or equivalent Measuring Frequency: (0.5nH~30nH) 500MHz (33nH~120nH) 300MHz (130nH~470nH) 100MHz Measuring Condition: Test signal level / about 0dBm Electrical length / 10mm Weight / about 1N to 5N Measuring Fixture: KEYSIGHT 16197A Position coil under test as shown in below and contact coil with each terminal by adding weight. Bottom side should be a bottom, and should be in the direction of the fixture for position of chip coil.
7.2	Q	Q shall meet item 3.	 <p>Measuring Method: See the endnote. <Electrical Performance: Measuring Method of Inductance/Q></p>
7.3	DC Resistance	DC Resistance shall meet item 3.	Measuring Equipment: Digital multi meter
7.4	Self Resonant Frequency(S.R.F)	S.R.F shall meet item 3.	Measuring Equipment: KEYSIGHT N5230A or equivalent
7.5	Rated Current	Self temperature rise shall be limited to 25°C max.	The rated current is applied.

8.Mechanical Performance

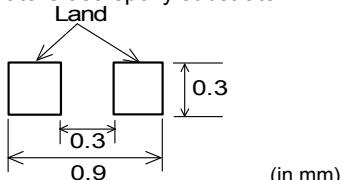
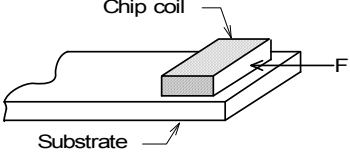
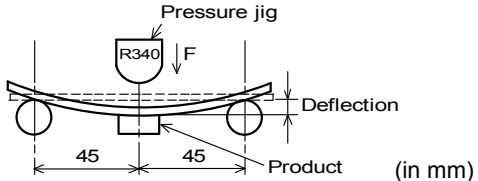
No.	Item	Specification	Test Method
8.1	Shear Test	Chip coil shall not be damaged after tested as test method.	Substrate:Glass-epoxy substrate  Force:2N Hold Duration:5 s±1 s Applied Direction: Parallel to PCB. 
8.2	Bending Test	Chip coil shall not be damaged after tested as test method.	Substrate:Glass-epoxy substrate (100mm × 40mm × 0.8mm) Speed of Applying Force:1mm /s Deflection:1mm Hold Duration:30 s 
8.3	Vibration	Appearance:No damage Inductance Change: within ±10%	Substrate: Glass-epoxy substrate Oscillation Frequency: 10Hz to 2000Hz to 10Hz for 20 min Total amplitude 1.5 mm or Acceleration amplitude 196 m/s ² whichever is smaller. Testing Time: A period of 2h in each of 3 mutually perpendicular directions.
8.4	Solderability	The electrode shall be at least 90% covered with new solder coating.	Flux: Ethanol solution of rosin 25(wt)% (Immersed for 5s to 10s) Solder:Sn-3.0Ag-0.5Cu Pre-Heating:150°C±10°C / 60s to 90s Solder Temperature:240°C±5°C Immersion Time:3s±1s
8.5	Resistance to Soldering Heat	Appearance:No damage Inductance Change: within ±10%	Flux: Ethanol solution of rosin 25(wt)% (Immersed for 5s to 10s) Solder:Sn-3.0Ag-0.5Cu Pre-Heating:150°C±10°C / 60s to 90s Solder Temperature:260°C±5°C Immersion Time:5s±1s Then measured after exposure in the room condition for 24h±2h.

9.Environmental Performance

It shall be soldered on the substrate.

No.	Item	Specification	Test Method
9.1	Heat Resistance	Appearance:No damage Inductance Change: within ±10%	Substrate: Glass-epoxy substrate Temperature:125°C Time:1000h (+48h,-0h) Then measured after exposure in the room condition for 24h±2h.

It shall be soldered on the substrate.

No.	Item	Specification	Test Method
9.2	Cold Resistance	Appearance:No damage Inductance Change: within $\pm 10\%$	Substrate: Glass-epoxy substrate Temperature:-55°C Time:1000 h (+48h,-0h) Then measured after exposure in the room condition for 24h \pm 2h.
9.3	Humidity		Substrate: Glass-epoxy substrate Temperature:40°C \pm 2°C Humidity:90%(RH) to 95%(RH) Time:1000 h(+48h,-0h) Then measured after exposure in the room condition for 24h \pm 2h.
9.4	Temperature Cycle		Substrate: Glass-epoxy substrate 1 cycle: 1 step: -55°C / 30min \pm 3 min 2 step: Ordinary temp. / 10~15 min 3 step: 125°C / 30min \pm 3 min 4 step: Ordinary temp. / 10~15 min Total of 10 cycles Then measured after exposure in the room condition for 24h \pm 2h.

10.Specification of Packaging

10.1 Appearance and Dimensions of paper tape (8mm-wide)

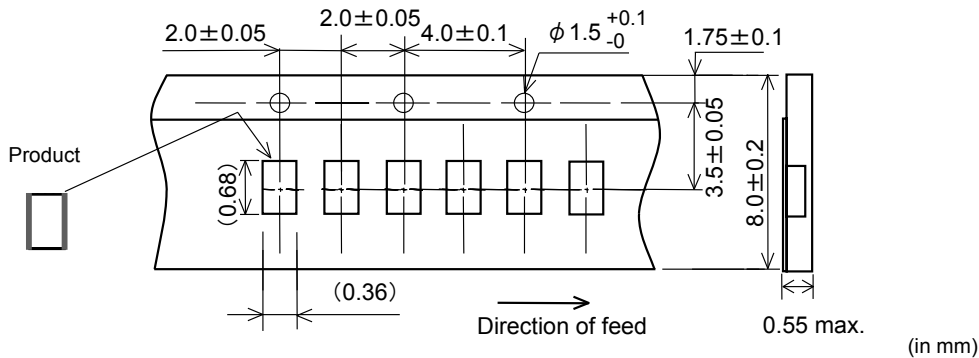

10.2 Specification of Taping

- (1) Packing quantity (standard quantity)
15,000 pcs. / reel
- (2) Packing Method
Products shall be packed in the cavity of the base tape and sealed by cover tape.
- (3) Sprocket hole
The sprocket holes are to the right as the tape is pulled toward the user.
- (4) Spliced point
Base tape and Cover tape has no spliced point.
- (5) Missing components number
Missing components number within 0.1 % of the number per reel or 1 pc. , whichever is greater, and are not continuous. The Specified quantity per reel is kept.

10.3 Pull Strength

Cover tape	5N min
------------	--------

10.4 Peeling off force of cover tape

Speed of Peeling off	300mm/min
Peeling off force	0.1N to 0.6N (minimum value is typical)

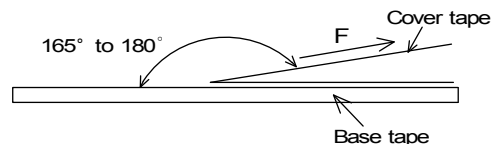

10.5 Dimensions of Leader-tape, Trailer and Reel

There shall be leader-tape (top tape and empty tape) and trailer-tape (empty tape) as follows.

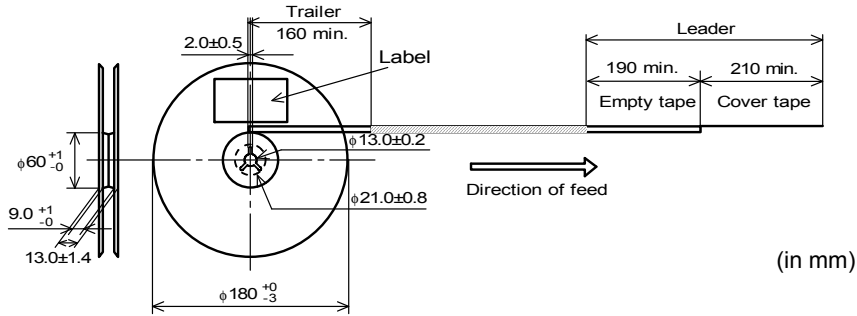

10.6 Marking for reel

Customer part number, MURATA part number, Inspection number(*1) , RoHS Marking (*2), Quantity etc ...

*1) <Expression of Inspection No.>

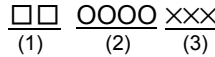

- (1) Factory Code
- (2) Date
- (3) Serial No.

First digit : Year / Last digit of year
 Second digit : Month / Jan. to Sep. → 1 to 9, Oct. to Dec. → O,N,D
 Third, Fourth digit : Day

*2) <Expression of RoHS Marking>

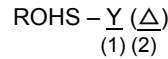

- (1) RoHS regulation conformity parts.
- (2) MURATA classification number

10.7 Marking for Outside package (corrugated paper box)

Customer name, Purchasing order number, Customer part number, MURATA part number, RoHS Marking (*2) ,Quantity, etc ...

10.8 Specification of Outer Case

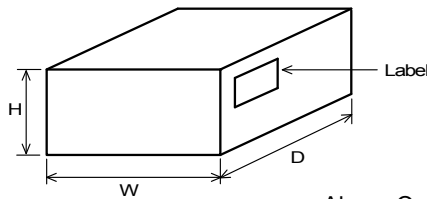

Outer Case Dimensions (mm)			Standard Reel Quantity in Outer Case (Reel)
W	D	H	
186	186	93	5

* Above Outer Case size is typical. It depends on a quantity of an order.

11. ⚠ Caution

Limitation of Applications

Please contact us before using our products for the applications listed below which require especially high reliability for the prevention of defects which might directly cause damage to the third party's life, body or property.

- (1) Aircraft equipment
- (2) Aerospace equipment
- (3) Undersea equipment
- (4) Power plant control equipment
- (5) Medical equipment
- (6) Transportation equipment (vehicles, trains, ships, etc.)
- (7) Traffic signal equipment
- (8) Disaster prevention / crime prevention equipment
- (9) Data-processing equipment
- (10) Applications of similar complexity and /or reliability requirements to the applications listed in the above

12. Notice

Products can only be soldered with reflow.
 This product is designed for solder mounting.
 Please consult us in advance for applying other mounting method such as conductive adhesive.

12.1 Land pattern designing

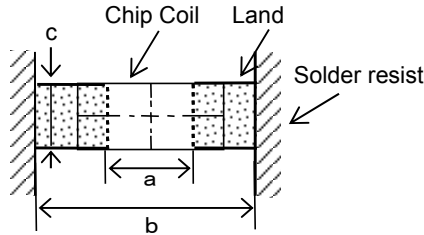

a	0.3
b	0.9
c	0.25~0.30

(in mm)

12.2 Flux, Solder

- Use rosin-based flux.
Don't use highly acidic flux with halide content exceeding 0.2(wt)% (chlorine conversion value).
Don't use water-soluble flux.
- Use Sn-3.0Ag-0.5Cu solder.
- Standard thickness of solder paste : 100 μm

12.3 Reflow soldering conditions

- Pre-heating should be in such a way that the temperature difference between solder and product surface is limited to 150°C max. Cooling into solvent after soldering also should be in such a way that the temperature difference is limited to 100°C max.
Insufficient pre-heating may cause cracks on the product, resulting in the deterioration of products quality.
- Standard soldering profile and the limit soldering profile is as follows.
The excessive limit soldering conditions may cause leaching of the electrode and / or resulting in the deterioration of product quality.
- Reflow soldering profile

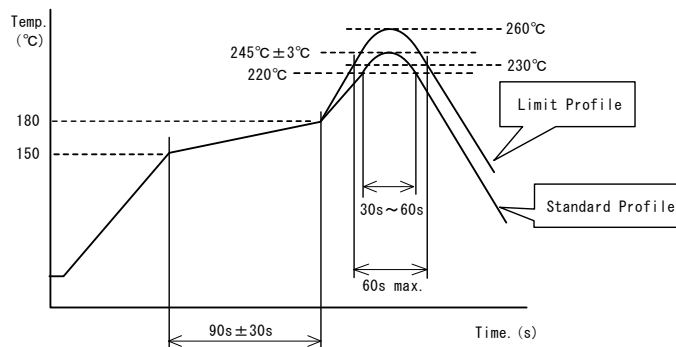

	Standard Profile	Limit Profile
Pre-heating	150°C~180°C , 90s±30s	
Heating	above 220°C, 30s~60s	above 230°C, 60s max.
Peak temperature	245°C±3°C	260°C, 10s
Cycle of reflow	2 times	

12.4 Reworking with soldering iron

The following conditions must be strictly followed when using a soldering iron.

Pre-heating	150°C, 1 min
Tip temperature	350°C max.
Soldering iron output	80W max.
Tip diameter	φ3mm max.
Soldering time	3(+1,-0)s
Time	2 times

Note : Do not directly touch the products with the tip of the soldering iron in order to prevent the crack on the products due to the thermal shock.

12.5 Solder Volume

- Solder shall be used not to be exceeded the upper limits as shown below.

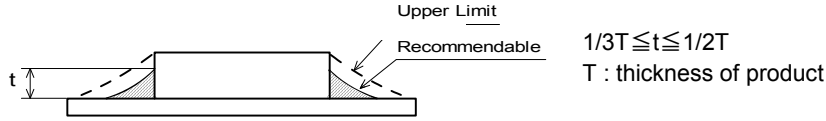

Accordingly increasing the solder volume, the mechanical stress to Chip is also increased. Exceeding solder volume may cause the failure of mechanical or electrical performance.

12.6 Attention regarding P.C.B. bending

The following shall be considered when designing and laying out P.C.B.'s.

- P.C.B. shall be designed so that products are not subject to the mechanical stress due to warping the board.

[Products direction]

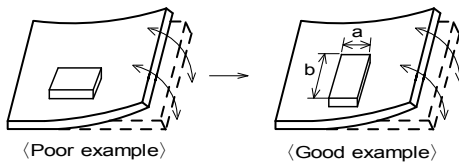

Products shall be located in the sideways direction (Length: $a < b$) to the mechanical stress.

- Components location on P.C.B. separation.

It is effective to implement the following measures, to reduce stress in separating the board.

It is best to implement all of the following three measures; however, implement as many measures as possible to reduce stress.

Contents of Measures	Stress Level
(1) Turn the mounting direction of the component parallel to the board separation surface.	A > D *1
(2) Add slits in the board separation part.	A > B
(3) Keep the mounting position of the component away from the board separation surface.	A > C

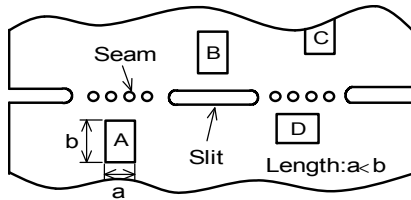

*1 A > D is valid when stress is added vertically to the perforation as with Hand Separation. If a Cutting Disc is used, stress will be diagonal to the PCB, therefore A > D is invalid.

- Mounting Components Near Screw Holes

When a component is mounted near a screw hole, it may be affected by the board deflection that occurs during the tightening of the screw. Mount the capacitor in a position as far away from the screw holes as possible.

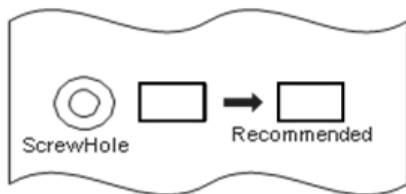

12.7 Cleaning Conditions

Products shall be cleaned on the following conditions.

- (1) Cleaning temperature shall be limited to 60°C max.(40°C max for IPA)
- (2) Ultrasonic cleaning shall comply with the following conditions with avoiding the resonance phenomenon at the mounted products and P.C.B.
Power : 20 W / l max. Frequency : 28kHz to 40kHz Time : 5 min max.
- (3) Cleaner
 1. Alcohol type cleaner
Isopropyl alcohol (IPA)
 2. Aqueous agent
PINE ALPHA ST-100S
- (4) There shall be no residual flux and residual cleaner after cleaning.
In the case of using aqueous agent, products shall be dried completely after rinse with de-ionized water in order to remove the cleaner.
- (5) Other cleaning Please contact us.

12.8 Resin coating

When products are coated with resin, please contact us in advance.

12.9 Handling of a substrate

- (1) There is a possibility of chip cracking caused by PCB expansion/contraction with heat, because stress on a chip is different depending on PCB material and structure.
When the thermal expansion coefficient greatly differs between the board used for mounting and the chip, it will cause cracking of the chip due to the thermal expansion and contraction.
The chip is assumed to be mounted on the PCB of glass-epoxy material, and we don't test with other PCB material which has different thermal expansion coefficient from Glass-epoxy.
When other PCB materials are considered, please be sure to evaluate by yourself.
- (2) After mounting products on a substrate, do not apply any stress to the product caused by bending or twisting to the substrate when cropping the substrate, inserting and removing a connector from the substrate or tightening screw to the substrate.
Excessive mechanical stress may cause cracking in the product.
In case of the mounting on flexible PCB, there is a possibility of chip cracking caused by mechanical stress even from small bending or twisting.
When the flexible PCB is considered, please be sure to evaluate by yourself.

Bending

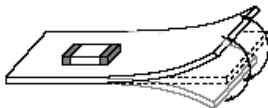

Twisting

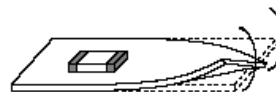
**12.10 Storage and Handling Requirements**

- (1) Storage period
 - Use the products within 12 months after delivered.
 - Solderability should be checked if this period is exceeded.
- (2) Storage conditions
 - Products should be stored in the warehouse on the following conditions.
 - Temperature : -10°C ~ 40°C
 - Humidity : 15% to 85% relative humidity No rapid change on temperature and humidity.
 - Products should not be stored on bulk packaging condition to prevent the chipping of the core and the breaking of winding wire caused by the collision between the products.
 - Products should be stored on the palette for the prevention of the influence from humidity, dust and so on.
 - Products should be stored in the warehouse without heat shock, vibration, direct sunlight and so on.
- (3) Handling Condition
 - Care should be taken when transporting or handling product to avoid excessive vibration or mechanical shock.

13. ⚠ Note

- (1) Please make sure that your product has been evaluated in view of your specifications with our product being mounted to your product.
- (2) You are requested not to use our product deviating from the reference specifications.
- (3) The contents of this reference specification are subject to change without advance notice.
Please approve our product specifications or transact the approval sheet for product specifications before ordering.

<Electrical Performance:Measuring Method of Inductance/Q>

(1) Residual elements and stray elements of test fixture can be described by F-parameter shown in following.

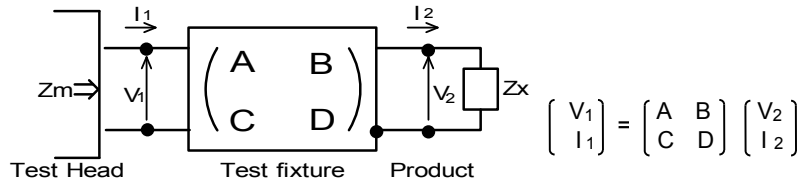

(2) The impedance of chip coil Z_x and measured value Z_m can be described by input/output current/voltage.

$$Z_m = \frac{V_1}{I_1}, \quad Z_x = \frac{V_2}{I_2}$$

(3) Thus, the relation between Z_x and Z_m is following;

$$Z_x = \alpha \frac{Z_m - \beta}{1 - Z_m \Gamma}$$

where, $\alpha = D / A = 1$
 $\beta = B / D = Z_{sm} - (1 - Y_{om} Z_{sm}) Z_{ss}$
 $\Gamma = C / A = Y_{om}$

$\left\{ \begin{array}{l} Z_{sm}: \text{measured impedance of short chip} \\ Z_{ss}: \text{residual impedance of short chip (0.480nH)} \\ Y_{om}: \text{measured admittance when opening the fixture} \end{array} \right\}$

(4) L_x and Q_x shall be calculated with the following equation.

$$L_x = \frac{\text{Im}(Z_x)}{2\pi f}, \quad Q_x = \frac{\text{Im}(Z_x)}{\text{Re}(Z_x)}$$

L_x : Inductance of chip coil
 Q_x : Q of chip coil
 f : Measuring frequency

Looking for pricing, stock, or lifecycle information?

Click below to explore more details on WIN SOURCE:

- ⊖ [View LQP03HQ4N7H02D on WIN SOURCE](#)
- ⊖ [Murata Electronics North America Information](#)

Optimize Your Supply Chain with WIN SOURCE Solutions

- ✓ Global Sourcing Solution
- ✓ Obsolete Management
- ✓ Cost Control Management
- ✓ Shortage Management
- ✓ Alternative Solution
- ✓ Excess Inventory Management