



**THE DATASHEET OF
NTD4302G**



NTD4302

MOSFET – Power, N-Channel, DPAK/IPAK 68 A, 30 V



ON Semiconductor®

<http://onsemi.com>

Features

- Ultra Low $R_{DS(on)}$
- Higher Efficiency Extending Battery Life
- Logic Level Gate Drive
- Diode Exhibits High Speed, Soft Recovery
- Avalanche Energy Specified
- I_{DSS} Specified at Elevated Temperature
- DPAK Mounting Information Provided
- These Devices are Pb-Free and are RoHS Compliant

Applications

- DC-DC Converters
- Low Voltage Motor Control
- Power Management in Portable and Battery Powered Products: i.e., Computers, Printers, Cellular and Cordless Telephones, and PCMCIA Cards

MAXIMUM RATINGS ($T_C = 25^\circ\text{C}$ unless otherwise noted)

Rating	Symbol	Value	Unit
Drain-to-Source Voltage	V_{DSS}	30	Vdc
Gate-to-Source Voltage – Continuous	V_{GS}	± 20	Vdc
Thermal Resistance – Junction-to-Case	$R_{\theta JC}$	1.65	$^\circ\text{C/W}$
Total Power Dissipation @ $T_C = 25^\circ\text{C}$	P_D	75	W
Continuous Drain Current @ $T_C = 25^\circ\text{C}$ (Note 4)	I_D	68	A
Continuous Drain Current @ $T_C = 100^\circ\text{C}$	I_D	43	A
Thermal Resistance – Junction-to-Ambient (Note 2)	$R_{\theta JA}$	67	$^\circ\text{C/W}$
Total Power Dissipation @ $T_A = 25^\circ\text{C}$	P_D	1.87	W
Continuous Drain Current @ $T_A = 25^\circ\text{C}$	I_D	11.3	A
Continuous Drain Current @ $T_A = 100^\circ\text{C}$	I_D	7.1	A
Pulsed Drain Current (Note 3)	I_{DM}	36	A
Thermal Resistance – Junction-to-Ambient (Note 1)	$R_{\theta JA}$	120	$^\circ\text{C/W}$
Total Power Dissipation @ $T_A = 25^\circ\text{C}$	P_D	1.04	W
Continuous Drain Current @ $T_A = 25^\circ\text{C}$	I_D	8.4	A
Continuous Drain Current @ $T_A = 100^\circ\text{C}$	I_D	5.3	A
Pulsed Drain Current (Note 3)	I_{DM}	28	A
Operating and Storage Temperature Range	T_J, T_{stg}	-55 to 150	$^\circ\text{C}$
Single Pulse Drain-to-Source Avalanche Energy – Starting $T_J = 25^\circ\text{C}$ ($V_{DD} = 30\text{ Vdc}$, $V_{GS} = 10\text{ Vdc}$, Peak $I_L = 17\text{ Apk}$, $L = 5.0\text{ mH}$, $R_G = 25\ \Omega$)	E_{AS}	722	mJ
Maximum Lead Temperature for Soldering Purposes, 1/8 in from case for 10 seconds	T_L	260	$^\circ\text{C}$

Stresses exceeding those listed in the Maximum Ratings table may damage the device. If any of these limits are exceeded, device functionality should not be assumed, damage may occur and reliability may be affected.

1. When surface mounted to an FR4 board using the minimum recommended pad size.
2. When surface mounted to an FR4 board using 0.5 sq. in. drain pad size.
3. Pulse Test: Pulse Width = 300 μs , Duty Cycle = 2%.
4. Current Limited by Internal Lead Wires.

$V_{(BR)DSS}$	$R_{DS(on)}$ TYP	I_D MAX
30 V	7.8 m Ω @ 10 V	68 A

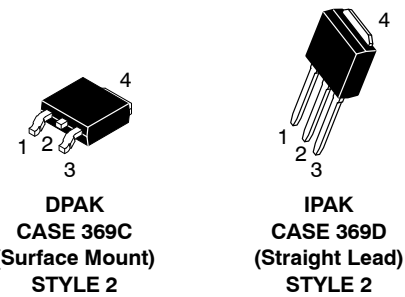
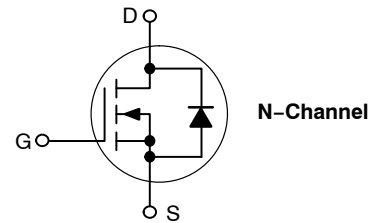

MARKING DIAGRAMS & PIN ASSIGNMENTS

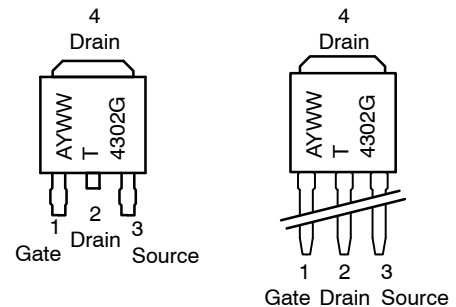

- A = Assembly Location*
- Y = Year
- WW = Work Week
- T4302 = Device Code
- G = Pb-Free Package

* The Assembly Location code (A) is front side optional. In cases where the Assembly Location is stamped in the package, the front side assembly code may be blank.

ORDERING INFORMATION

See detailed ordering and shipping information in the package dimensions section on page 5 of this data sheet.

NTD4302

ELECTRICAL CHARACTERISTICS (T_J = 25°C unless otherwise noted)

Characteristic	Symbol	Min	Typ	Max	Unit
----------------	--------	-----	-----	-----	------

OFF CHARACTERISTICS

Drain-Source Breakdown Voltage (V _{GS} = 0 Vdc, I _D = 250 μA) Positive Temperature Coefficient	V _{(BR)DSS}	30	-	-	Vdc
		-	25	-	mV/°C
Zero Gate Voltage Drain Current (V _{GS} = 0 Vdc, V _{DS} = 30 Vdc, T _J = 25°C) (V _{GS} = 0 Vdc, V _{DS} = 30 Vdc, T _J = 125°C)	I _{DSS}	-	-	1.0	μAdc
		-	-	10	μAdc
Gate-Body Leakage Current (V _{GS} = ±20 Vdc, V _{DS} = 0 Vdc)	I _{GSS}	-	-	±100	nAdc

ON CHARACTERISTICS

Gate Threshold Voltage (V _{DS} = V _{GS} , I _D = 250 μAdc) Negative Temperature Coefficient	V _{GS(th)}	1.0	1.9	3.0	Vdc
		-	-3.8	-	Vdc
Static Drain-Source On-State Resistance (V _{GS} = 10 Vdc, I _D = 20 Adc) (V _{GS} = 10 Vdc, I _D = 10 Adc) (V _{GS} = 4.5 Vdc, I _D = 5.0 Adc)	R _{DS(on)}	-	0.0078	0.010	Ω
		-	0.0078	0.010	Ω
		-	0.010	0.013	Ω
Forward Transconductance (V _{DS} = 15 Vdc, I _D = 10 Adc)	g _{FS}	-	20	-	Mhos

DYNAMIC CHARACTERISTICS

Input Capacitance	(V _{DS} = 24 Vdc, V _{GS} = 0 Vdc, f = 1.0 MHz)	C _{iss}	-	2050	2400	pF
Output Capacitance		C _{oss}	-	640	800	
Reverse Transfer Capacitance		C _{rss}	-	225	310	

SWITCHING CHARACTERISTICS (Note 6)

Turn-On Delay Time	(V _{DD} = 25 Vdc, I _D = 1.0 Adc, V _{GS} = 10 Vdc, R _G = 6.0 Ω)	t _{d(on)}	-	11	20	ns
Rise Time		t _r	-	15	25	
Turn-Off Delay Time		t _{d(off)}	-	85	130	
Fall Time		t _f	-	55	90	
Turn-On Delay Time	(V _{DD} = 25 Vdc, I _D = 1.0 Adc, V _{GS} = 10 Vdc, R _G = 2.5 Ω)	t _{d(on)}	-	11	20	ns
Rise Time		t _r	-	13	20	
Turn-Off Delay Time		t _{d(off)}	-	55	90	
Fall Time		t _f	-	40	75	
Turn-On Delay Time	(V _{DD} = 24 Vdc, I _D = 20 Adc, V _{GS} = 10 Vdc, R _G = 2.5 Ω)	t _{d(on)}	-	15	-	ns
Rise Time		t _r	-	25	-	
Turn-Off Delay Time		t _{d(off)}	-	40	-	
Fall Time		t _f	-	58	-	
Gate Charge	(V _{DS} = 24 Vdc, I _D = 2.0 Adc, V _{GS} = 10 Vdc)	Q _T	-	55	80	nC
		Q _{gs} (Q1)	-	5.5	-	
		Q _{gd} (Q2)	-	15	-	

BODY-DRAIN DIODE RATINGS (Note 5)

Diode Forward On-Voltage (I _S = 2.3 Adc, V _{GS} = 0 Vdc) (I _S = 20 Adc, V _{GS} = 0 Vdc) (I _S = 2.3 Adc, V _{GS} = 0 Vdc, T _J = 125°C)	V _{SD}	-	0.75	1.0	Vdc	
		-	0.90	-	Vdc	
		-	0.65	-	Vdc	
Reverse Recovery Time	(I _S = 2.3 Adc, V _{GS} = 0 Vdc, di _S /dt = 100 A/μs)	t _{rr}	-	39	65	ns
		t _a	-	20	-	
		t _b	-	19	-	
Reverse Recovery Stored Charge	Q _{rr}	-	0.043	-	μC	

Product parametric performance is indicated in the Electrical Characteristics for the listed test conditions, unless otherwise noted. Product performance may not be indicated by the Electrical Characteristics if operated under different conditions.

5. Indicates Pulse Test: Pulse Width = 300 μsec max, Duty Cycle ≤ 2%.

6. Switching characteristics are independent of operating junction temperature.

TYPICAL CHARACTERISTICS

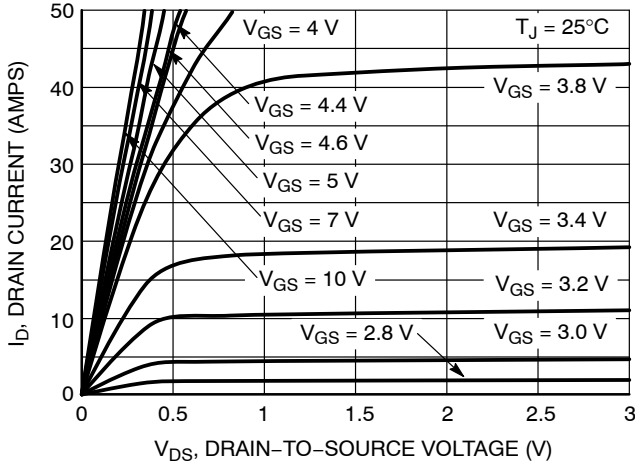

Figure 1. On-Region Characteristics

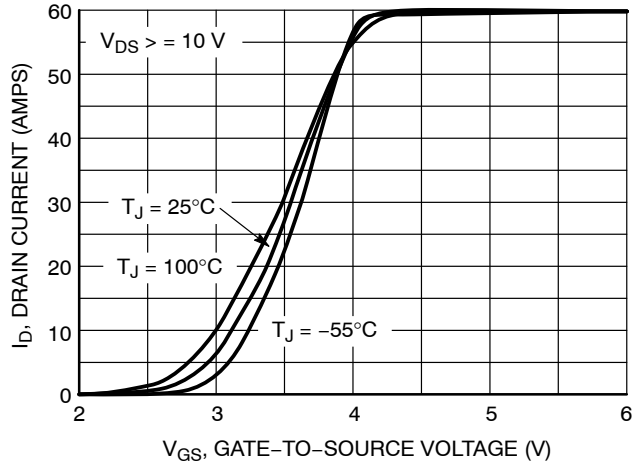

Figure 2. Transfer Characteristics

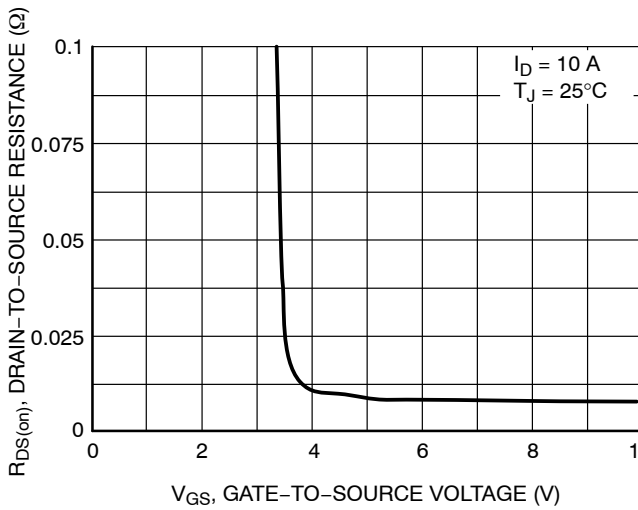

Figure 3. On-Resistance vs. Gate-to-Source Voltage

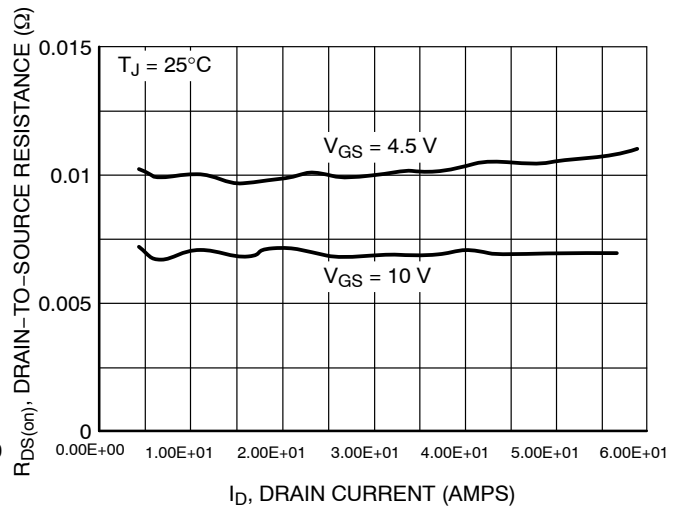

Figure 4. On-Resistance vs. Drain Current and Gate Voltage

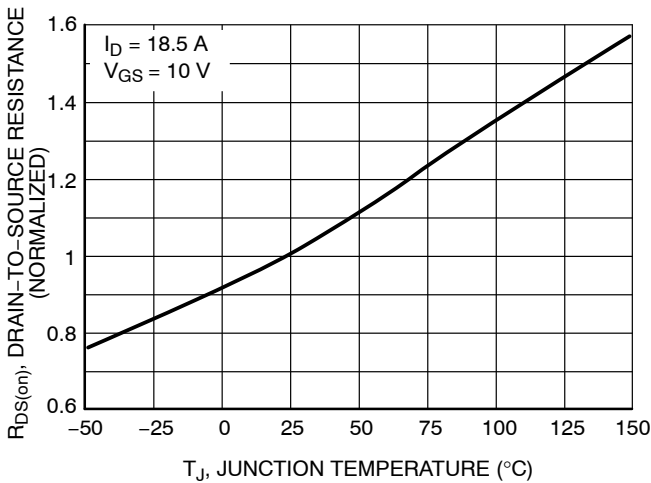

Figure 5. On-Resistance Variation with Temperature

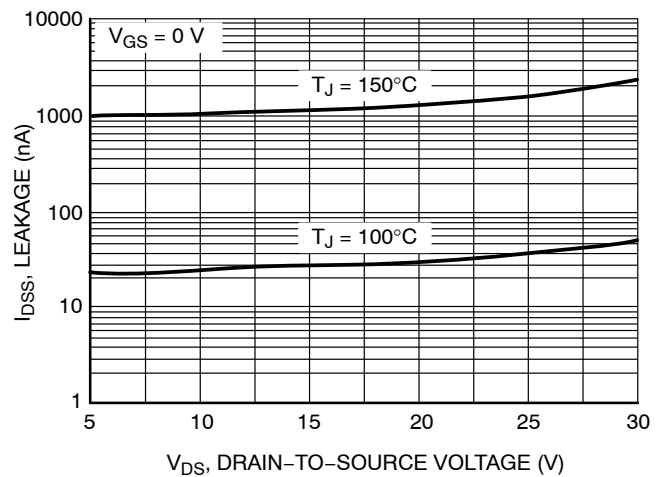

Figure 6. Drain-to-Source Leakage Current vs. Voltage

TYPICAL CHARACTERISTICS

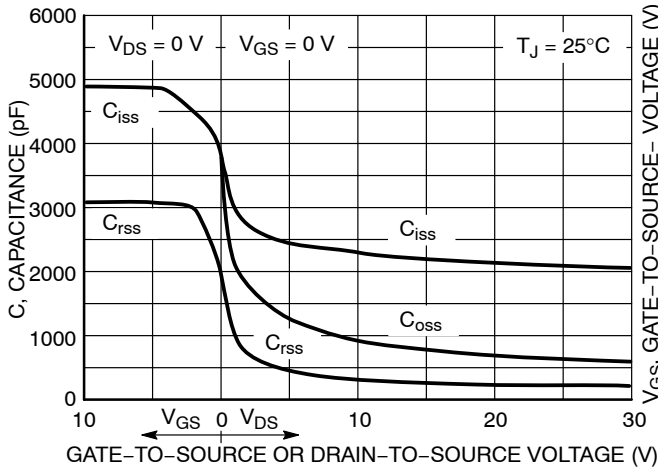

Figure 7. Capacitance Variation

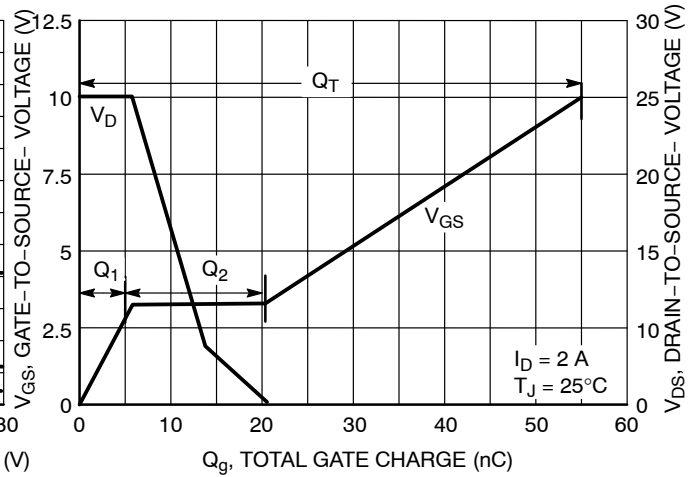

Figure 8. Gate-to-Source and Drain-to-Source Voltage vs. Total Charge

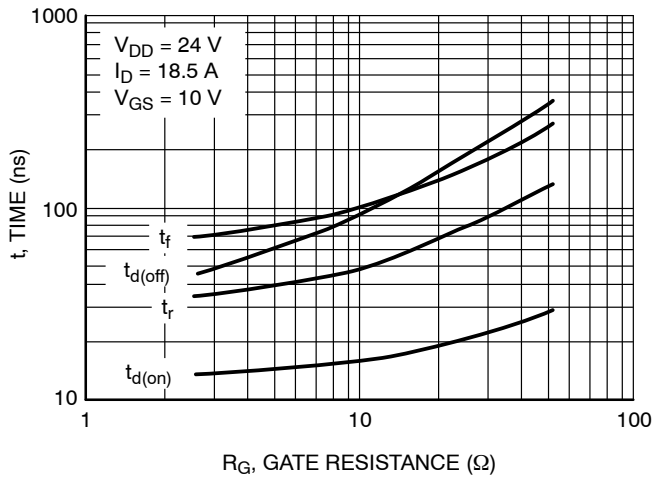

Figure 9. Resistive Switching Time Variation vs. Gate Resistance

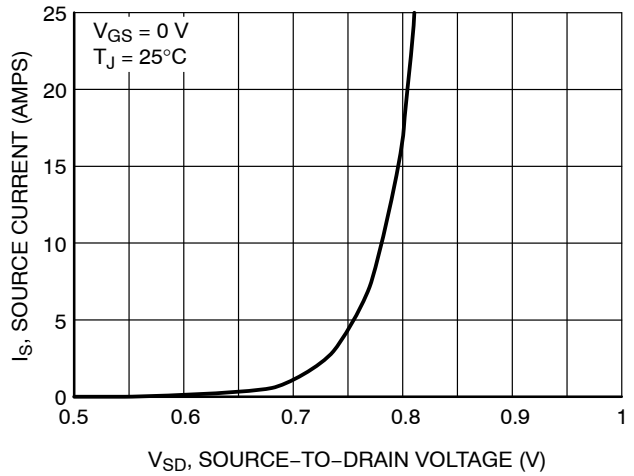

Figure 10. Diode Forward Voltage vs. Current

NTD4302

TYPICAL CHARACTERISTICS

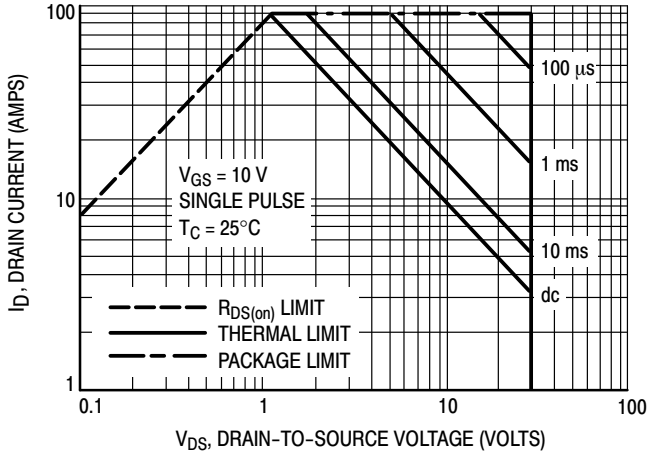

Figure 11. Maximum Rated Forward Biased Safe Operating Area

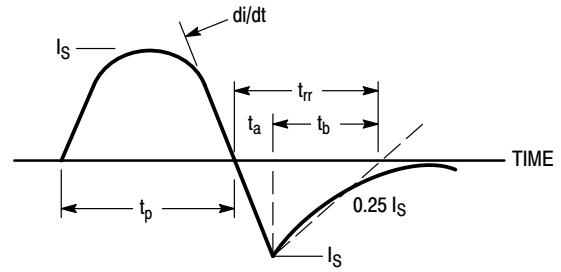

Figure 12. Diode Reverse Recovery Waveform

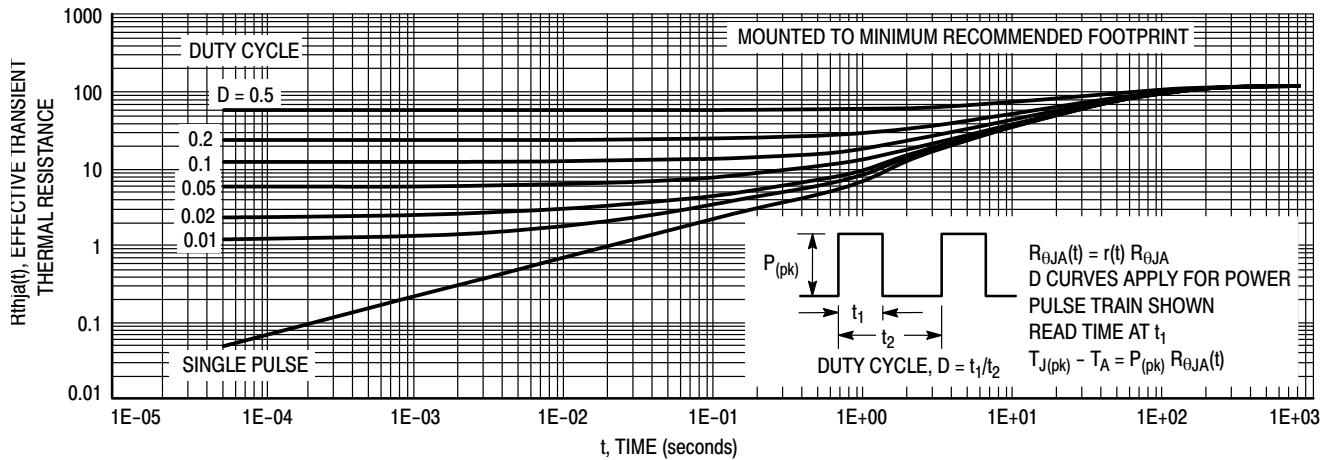

Figure 13. Thermal Response - Various Duty Cycles

ORDERING INFORMATION

Device	Package Type	Package	Shipping [†]
NTD4302G	DPAK	369C (Pb-Free)	75 Units / Rail
NTD4302-1G	IPAK	369D (Pb-Free)	75 Units / Rail
NTD4302T4G	DPAK	369C (Pb-Free)	2500 Tape & Reel

[†]For information on tape and reel specifications, including part orientation and tape sizes, please refer to our Tape and Reel Packaging Specifications Brochure, BRD8011/D.

NTD4302

PACKAGE DIMENSIONS

DPAK (SINGLE GAUGE) CASE 369C ISSUE E

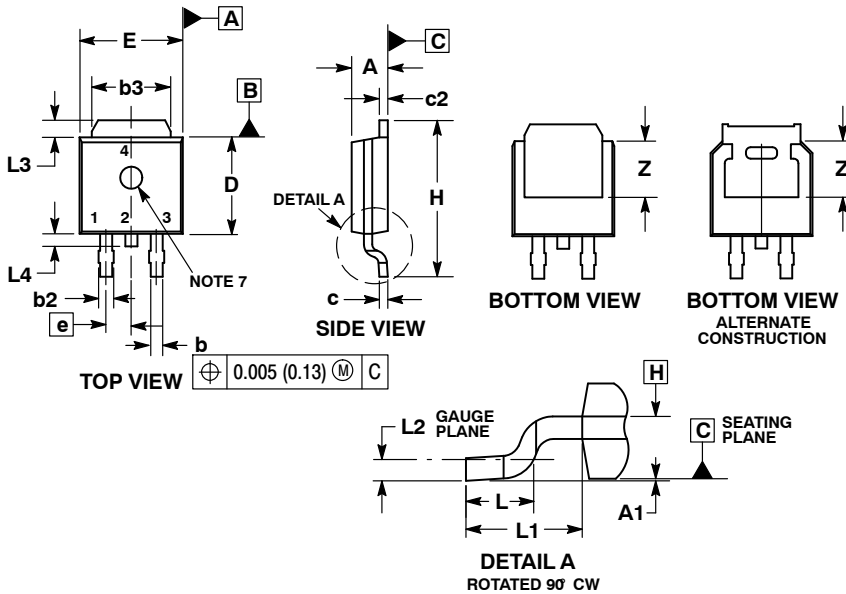

NOTES:

1. DIMENSIONING AND TOLERANCING PER ASME Y14.5M, 1994.
2. CONTROLLING DIMENSION: INCHES.
3. THERMAL PAD CONTOUR OPTIONAL WITHIN DIMENSIONS b3, L3 and Z.
4. DIMENSIONS D AND E DO NOT INCLUDE MOLD FLASH, PROTRUSIONS, OR BURRS. MOLD FLASH, PROTRUSIONS, OR GATE BURRS SHALL NOT EXCEED 0.006 INCHES PER SIDE.
5. DIMENSIONS D AND E ARE DETERMINED AT THE OUTERMOST EXTREMES OF THE PLASTIC BODY.
6. DATUMS A AND B ARE DETERMINED AT DATUM PLANE H.
7. OPTIONAL MOLD FEATURE.

DIM	INCHES		MILLIMETERS	
	MIN	MAX	MIN	MAX
A	0.086	0.094	2.18	2.38
A1	0.000	0.005	0.00	0.13
b	0.025	0.035	0.63	0.89
b2	0.028	0.045	0.72	1.14
b3	0.180	0.215	4.57	5.46
c	0.018	0.024	0.46	0.61
c2	0.018	0.024	0.46	0.61
D	0.235	0.245	5.97	6.22
E	0.250	0.265	6.35	6.73
e	0.090 BSC		2.29 BSC	
H	0.370	0.410	9.40	10.41
L	0.055	0.070	1.40	1.78
L1	0.114 REF		2.90 REF	
L2	0.020 BSC		0.51 BSC	
L3	0.035	0.050	0.89	1.27
L4	--- 0.040 ---		--- 1.01 ---	
Z	0.155	---	3.93	---

SOLDERING FOOTPRINT*

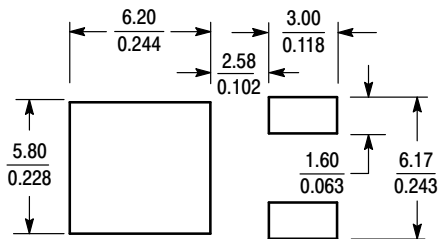

SCALE 3:1 (mm/inches)

STYLE 2:

1. GATE
2. DRAIN
3. SOURCE
4. DRAIN

*For additional information on our Pb-Free strategy and soldering details, please download the ON Semiconductor Soldering and Mounting Techniques Reference Manual, SOLDERRM/D.

NTD4302

PACKAGE DIMENSIONS

IPAK CASE 369D ISSUE C

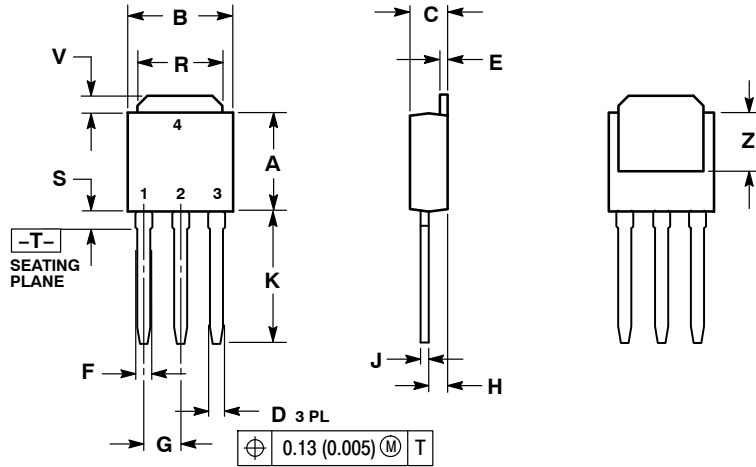

NOTES:

1. DIMENSIONING AND TOLERANCING PER ANSI Y14.5M, 1982.
2. CONTROLLING DIMENSION: INCH.

DIM	INCHES		MILLIMETERS	
	MIN	MAX	MIN	MAX
A	0.235	0.245	5.97	6.35
B	0.250	0.265	6.35	6.73
C	0.086	0.094	2.19	2.38
D	0.027	0.035	0.69	0.88
E	0.018	0.023	0.46	0.58
F	0.037	0.045	0.94	1.14
G	0.090 BSC		2.29 BSC	
H	0.034	0.040	0.87	1.01
J	0.018	0.023	0.46	0.58
K	0.350	0.380	8.89	9.65
R	0.180	0.215	4.45	5.45
S	0.025	0.040	0.63	1.01
V	0.035	0.050	0.89	1.27
Z	0.155	---	3.93	---

STYLE 2:

- PIN 1: GATE
 2. DRAIN
 3. SOURCE
 4. DRAIN

ON Semiconductor and the  are registered trademarks of Semiconductor Components Industries, LLC (SCILLC) or its subsidiaries in the United States and/or other countries. SCILLC owns the rights to a number of patents, trademarks, copyrights, trade secrets, and other intellectual property. A listing of SCILLC's product/patent coverage may be accessed at www.onsemi.com/site/pdf/Patent-Marking.pdf. SCILLC reserves the right to make changes without further notice to any products herein. SCILLC makes no warranty, representation or guarantee regarding the suitability of its products for any particular purpose, nor does SCILLC assume any liability arising out of the application or use of any product or circuit, and specifically disclaims any and all liability, including without limitation special, consequential or incidental damages. "Typical" parameters which may be provided in SCILLC data sheets and/or specifications can and do vary in different applications and actual performance may vary over time. All operating parameters, including "Typicals" must be validated for each customer application by customer's technical experts. SCILLC does not convey any license under its patent rights nor the rights of others. SCILLC products are not designed, intended, or authorized for use as components in systems intended for surgical implant into the body, or other applications intended to support or sustain life, or for any other application in which the failure of the SCILLC product could create a situation where personal injury or death may occur. Should Buyer purchase or use SCILLC products for any such unintended or unauthorized application, Buyer shall indemnify and hold SCILLC and its officers, employees, subsidiaries, affiliates, and distributors harmless against all claims, costs, damages, and expenses, and reasonable attorney fees arising out of, directly or indirectly, any claim of personal injury or death associated with such unintended or unauthorized use, even if such claim alleges that SCILLC was negligent regarding the design or manufacture of the part. SCILLC is an Equal Opportunity/Affirmative Action Employer. This literature is subject to all applicable copyright laws and is not for resale in any manner.

PUBLICATION ORDERING INFORMATION

LITERATURE FULFILLMENT:

Literature Distribution Center for ON Semiconductor
 P.O. Box 5163, Denver, Colorado 80217 USA
Phone: 303-675-2175 or 800-344-3860 Toll Free USA/Canada
Fax: 303-675-2176 or 800-344-3867 Toll Free USA/Canada
Email: orderlit@onsemi.com

N. American Technical Support: 800-282-9855 Toll Free
 USA/Canada
Europe, Middle East and Africa Technical Support:
 Phone: 421 33 790 2910
Japan Customer Focus Center
 Phone: 81-3-5817-1050

ON Semiconductor Website: www.onsemi.com
Order Literature: <http://www.onsemi.com/orderlit>

For additional information, please contact your local Sales Representative

Looking for pricing, stock, or lifecycle information?

Click below to explore more details on WIN SOURCE:

 [View NTD4302G on WIN SOURCE](#)

 [ON Semiconductor](#) Information

Optimize Your Supply Chain with WIN SOURCE Solutions

-  Global Sourcing Solution
-  Obsolete Management
-  Cost Control Management
-  Shortage Management
-  Alternative Solution
-  Excess Inventory Management