



**THE DATASHEET OF  
MC33761SNT1-028G**



# MC33761

## Ultra Low-Noise Low Dropout Voltage Regulator with 1.0 V ON/OFF Control

The MC33761 is an Low DropOut (LDO) regulator featuring excellent noise performances. Thanks to its innovative design, the circuit reaches an impressive 40  $\mu$ VRMS noise level *without* an external bypass capacitor. Housed in a small SOT-23 5 leads-like package, it represents the ideal designer's choice when space and noise are at premium. The absence of external bandgap capacitor accelerates the response time to a wake-up signal and keeps it within 40  $\mu$ s (in repetitive mode), making the MC33761 as a natural candidate for portable applications.

The MC33761 also hosts a novel architecture which prevents excessive undershoots in the presence of fast transient bursts, as in any bursting systems.

Finally, with a static line regulation better than -75 dB, it naturally shields the downstream electronics against choppy lines.

### Features

- Ultra-Low Noise: 150 nV/ $\sqrt{\text{Hz}}$  @ 100 Hz, 40  $\mu$ VRMS  
100 Hz-100 kHz Typical,  $I_{\text{out}} = 60 \text{ mA}$ ,  $C_o = 1.0 \mu\text{F}$
- Fast Response Time from OFF to ON: 40  $\mu$ s Typical at a 200 Hz Repetition Rate
- Ready for 1.0 V Platforms: ON with a 900 mV High Level
- Nominal Output Current of 80 mA with a 100 mA Peak Capability
- Typical Dropout of 90 mV @ 30 mA, 160 mV @ 80 mA
- Ripple Rejection: 70 dB @ 1.0 kHz
- 1.5% Output Precision @ 25°C
- Thermal Shutdown
- $V_{\text{out}}$  Available at 2.5 V, 2.8 V, 2.9 V, 3.0 V, 5.0 V
- Operating Range from -40 to +85°C
- Dual Version is Available as MC33762
- Pb-Free Packages are Available

### Applications

- Noise Sensitive Circuits: VCOs RF Stages, etc.
- Bursting Systems (TDMA Phones)
- All Battery Operated Devices

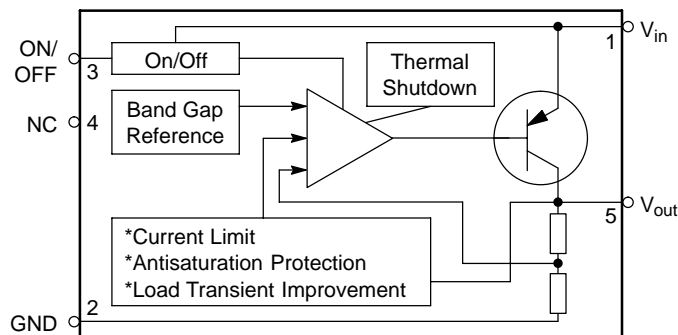
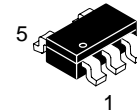

Figure 1. Simplified Block Diagram



**ON Semiconductor®**

<http://onsemi.com>



**THIN SOT-23-5  
SN SUFFIX  
CASE 483**

### PIN CONNECTIONS AND MARKING DIAGRAM

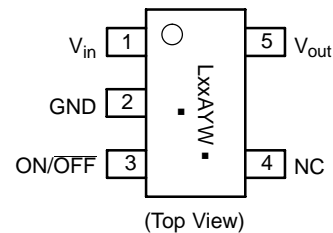

Lxx = Device Code  
A = Assembly Location  
Y = Year  
W = Work Week  
▪ = Pb-Free Package

(Note: Microdot may be in either location)

### ORDERING INFORMATION

See detailed ordering and shipping information in the package dimensions section on page 12 of this data sheet.

# MC33761

## PIN FUNCTION DESCRIPTIONS

Pin #	Pin Name	Function	Description
1	V <sub>in</sub>	Powers the IC	A positive voltage up to 12 V can be applied upon this pin.
2	GND	The IC's ground	
3	ON/OFF	Shuts or wakes-up the IC	A 900 mV level on this pin is sufficient to start the IC. A 150 mV shuts it down.
4	NC	None	It makes no arm to connect the pin to a known potential, like in a pin-to-pin replacement case.
5	V <sub>out</sub>	Delivers the output voltage	This pin requires a 1.0 μF output capacitor to be stable.

## MAXIMUM RATINGS

Rating	Pin #	Symbol	Value		Unit
			Min	Max	
Power Supply Voltage	1	V <sub>in</sub>	–	12	V
ESD Capability, HBM Model	All Pins	–	–	1.0	kV
ESD Capability, Machine Model	All Pins	–	–	200	V
Maximum Power Dissipation NW Suffix, Plastic Package	–	P <sub>D</sub>	–	Internally Limited	W
Thermal Resistance Junction-to-Air	–	R <sub>θJA</sub>	–	210	°C/W
Operating Ambient Temperature	–	T <sub>A</sub>	–	–40 to +85	°C
Maximum Junction Temperature (Note 1)	–	T <sub>Jmax</sub>	–	150	°C
Maximum Operating Junction Temperature (Note 2)	–	T <sub>J</sub>	–	125	°C
Storage Temperature Range	–	T <sub>stg</sub>	–	–60 to +150	°C

Stresses exceeding Maximum Ratings may damage the device. Maximum Ratings are stress ratings only. Functional operation above the Recommended Operating Conditions is not implied. Extended exposure to stresses above the Recommended Operating Conditions may affect device reliability.

## ELECTRICAL CHARACTERISTICS

(For typical values T<sub>A</sub> = 25°C, for min/max values T<sub>A</sub> = –40°C to +85°C, max T<sub>J</sub> = 125°C unless otherwise noted)

Characteristics	Pin #	Symbol	Min	Typ	Max	Unit
-----------------	-------	--------	-----	-----	-----	------

### LOGIC CONTROL SPECIFICATIONS

Input Voltage Range	3	V <sub>ON/OFF</sub>	0	–	V <sub>in</sub>	V
ON/OFF Input Resistance (all versions)	3	R <sub>ON/OFF</sub>	–	250	–	kΩ
ON/OFF Control Voltages (Note 3) Logic Zero, OFF State, I <sub>O</sub> = 50 mA Logic One, ON State, I <sub>O</sub> = 50 mA	3	V <sub>ON/OFF</sub>	– 900	– –	150 –	mV

### CURRENTS PARAMETERS

Current Consumption in OFF State (all versions) OFF Mode Current: V <sub>in</sub> = V <sub>out</sub> + 1.0 V, I <sub>O</sub> = 0, V <sub>OFF</sub> = 150 mV	–	I <sub>QOFF</sub>	–	0.1	2.0	μA
Current Consumption in ON State (all versions) ON Mode Current: V <sub>in</sub> = V <sub>out</sub> + 1.0 V, I <sub>O</sub> = 0, V <sub>ON</sub> = 3.5 V	–	I <sub>QON</sub>	–	180	–	μA
Current Consumption in ON State (all versions), ON Mode Saturation Current: V <sub>in</sub> = V <sub>out</sub> – 0.5 V, No Output Load	–	I <sub>QSAT</sub>	–	800	–	μA
Current Limit V <sub>in</sub> = V <sub>out,nom</sub> + 1.0 V, Output is brought to V <sub>out,nom</sub> – 0.3 V (all versions)	–	I <sub>MAX</sub>	100	180	500	mA

1. Internally limited by shutdown.
2. Specifications are guaranteed below this value.
3. Voltage slope should be greater than 2.0 mV/μs.

# MC33761

## ELECTRICAL CHARACTERISTICS (continued)

(For typical values  $T_A = 25^\circ\text{C}$ , for min/max values  $T_A = -40^\circ\text{C}$  to  $+85^\circ\text{C}$ , max  $T_J = 125^\circ\text{C}$  unless otherwise noted)

Characteristics	Pin #	Symbol	Min	Typ	Max	Unit
-----------------	-------	--------	-----	-----	-----	------

### OUTPUT VOLTAGES

$V_{out} + 1.0\text{ V} < V_{in} < 6.0\text{ V}$ , $T_A = 25^\circ\text{C}$ , $1.0\text{ mA} < I_{out} < 80\text{ mA}$ 2.5 V	5	$V_{out}$	2.462	2.5	2.537	V
2.8 V	5	$V_{out}$	2.758	2.8	2.842	V
2.9 V	5	$V_{out}$	2.857	2.9	2.943	V
3.0 V	5	$V_{out}$	2.955	3.0	3.045	V
5.0 V	5	$V_{out}$	4.925	5.0	5.075	V
Other Voltages up to 5.0 V Available in 50 mV Increment Steps	5	$V_{out}$	-1.5	X	+1.5	%
$V_{out} + 1.0\text{ V} < V_{in} < 6.0\text{ V}$ , $T_A = -40^\circ\text{C}$ to $+85^\circ\text{C}$ , $1.0\text{ mA} < I_{out} < 80\text{ mA}$ 2.5 V	5	$V_{out}$	2.425	2.5	2.575	V
2.8 V	5	$V_{out}$	2.716	2.8	2.884	V
2.9 V	5	$V_{out}$	2.813	2.9	2.987	
3.0 V	5	$V_{out}$	2.91	3.0	3.090	V
5.0 V	5	$V_{out}$	4.850	5.0	5.150	V
Other Voltages up to 5.0 V Available in 50 mV Increment Steps	5	$V_{out}$	-3.0	X	+3.0	%

### LINE AND LOAD REGULATION, DROPOUT VOLTAGES

Line Regulation (all versions) $V_{out} + 1.0\text{ V} < V_{in} < 12\text{ V}$ , $I_{out} = 80\text{ mA}$	5/1	$Reg_{line}$	-	-	20	mV
Load Regulation (all versions) $V_{in} = V_{out} + 1.0\text{ V}$ , $C_{out} = 1.0\text{ }\mu\text{F}$ , $I_{out} = 1.0$ to $80\text{ mA}$	5	$Reg_{load}$	-	-	40	mV
Dropout Voltage (all versions) (Note 4) $I_{out} = 30\text{ mA}$ $I_{out} = 60\text{ mA}$ $I_{out} = 80\text{ mA}$	5 5 5	$V_{in}-V_{out}$ $V_{in}-V_{out}$ $V_{in}-V_{out}$	- - -	90 140 160	150 200 250	mV

### DYNAMIC PARAMETERS

Ripple Rejection (all versions) $V_{in} = V_{out} + 1.0\text{ V} + 1.0\text{ kHz}$ 100 mVpp Sinusoidal Signal	5/1	Ripple	-	-70	-	dB
Output Noise Density @ 1.0 kHz	5	-	-	150	-	nV/ $\sqrt{\text{Hz}}$
RMS Output Noise Voltage (all versions) $C_{out} = 1.0\text{ }\mu\text{F}$ , $I_{out} = 50\text{ mA}$ , $F = 100\text{ Hz}$ to $1.0\text{ MHz}$	5	Noise	-	35	-	$\mu\text{V}$
Output Rise Time (all versions) $C_{out} = 1.0\text{ }\mu\text{F}$ , $I_{out} = 50\text{ mA}$ , 10% of Rising ON Signal to 90% of Nominal $V_{out}$	5	$t_{rise}$	-	40	-	$\mu\text{s}$

### THERMAL SHUTDOWN

Thermal Shutdown (all versions)	-	-	-	-	125	$^\circ\text{C}$
---------------------------------	---	---	---	---	-----	------------------

4.  $V_{out}$  is brought to  $V_{out} - 100\text{ mV}$ .

## DEFINITIONS

### Load Regulation

The change in output voltage for a change in output current at a constant chip temperature.

### Dropout Voltage

The input/output differential at which the regulator output no longer maintains regulation against further reductions in input voltage. Measured when the output drops 100 mV below its nominal value (which is measured at 1.0 V differential value). The dropout level is affected by the chip temperature, load current and minimum input supply requirements.

### Output Noise Voltage

This is the integrated value of the output noise over a specified frequency range. Input voltage and output current are kept constant during the measurement. Results are expressed in  $\mu\text{VRMS}$ .

### Maximum Power Dissipation

The maximum total dissipation for which the regulator will operate within its specs.

### Quiescent Current

The quiescent current is the current which flows through the ground when the LDO operates without a load on its output: internal IC operation, bias etc. When the LDO becomes loaded, this term is called the Ground current. It is actually the difference between the input current (measured through the LDO input pin) and the output current.

### Line Regulation

The change in output voltage for a change in input voltage. The measurement is made under conditions of low dissipation or by using pulse technique such that the average chip temperature is not significantly affected. One usually distinguishes *static line regulation* or *DC line regulation* (a DC step in the input voltage generates a corresponding step in the output voltage) from *ripple rejection* or *audio susceptibility* where the input is combined with a frequency generator to sweep from a few hertz up to a defined boundary while the output amplitude is monitored.

### Thermal Protection

Internal thermal shutdown circuitry is provided to protect the integrated circuit in the event that the maximum junction temperature is exceeded. When activated at typically 125°C, the regulator turns off. This feature is provided to prevent catastrophic failures from accidental overheating.

### Maximum Package Power Dissipation

The maximum power package power dissipation is the power dissipation level at which the junction temperature reaches its maximum operating value, i.e. 125°C. Depending on the ambient temperature, it is possible to calculate the maximum power dissipation and thus the maximum available output current.

CHARACTERIZATION CURVES

All curves taken with  $V_{in} = V_{out} + 1.0\text{ V}$ ,  $V_{out} = 2.8\text{ V}$ ,  $C_{out} = 1.0\text{ }\mu\text{F}$

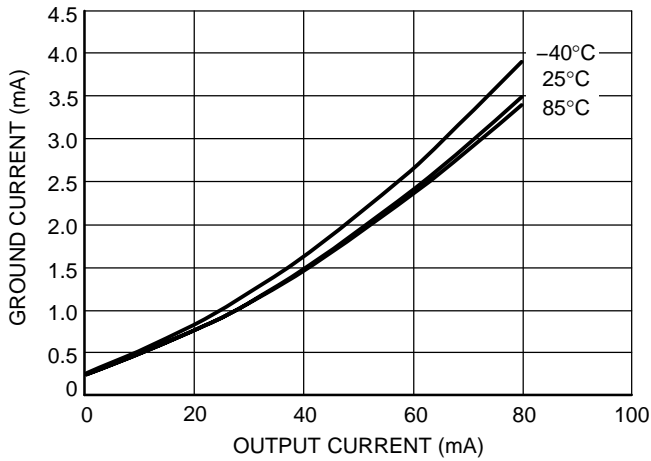

Figure 2. Ground Current versus Output Current

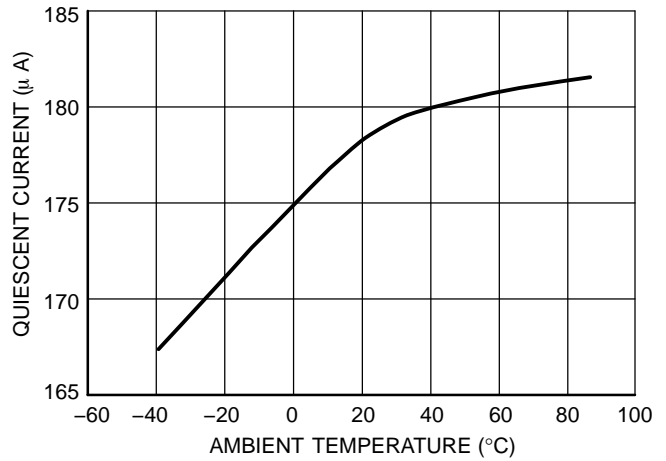

Figure 3. Quiescent Current versus Temperature

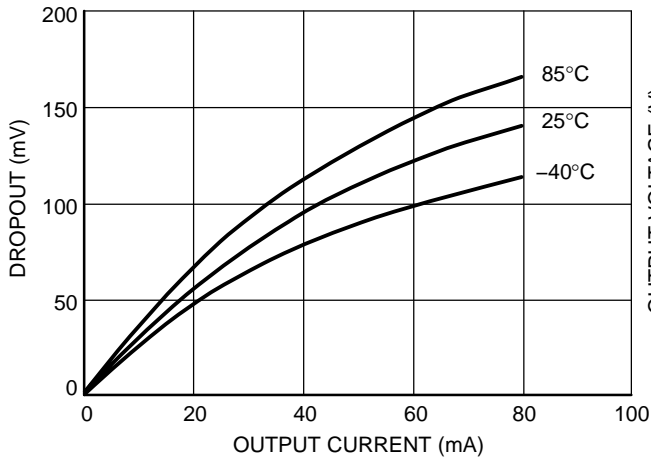

Figure 4. Dropout versus Output Current

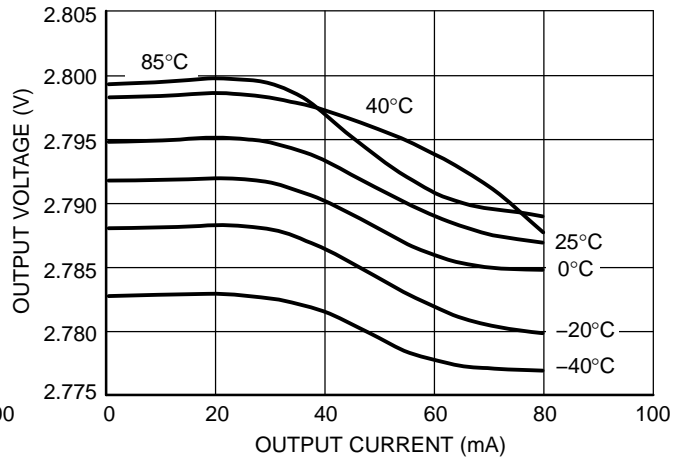

Figure 5. Output Voltage versus Output Current

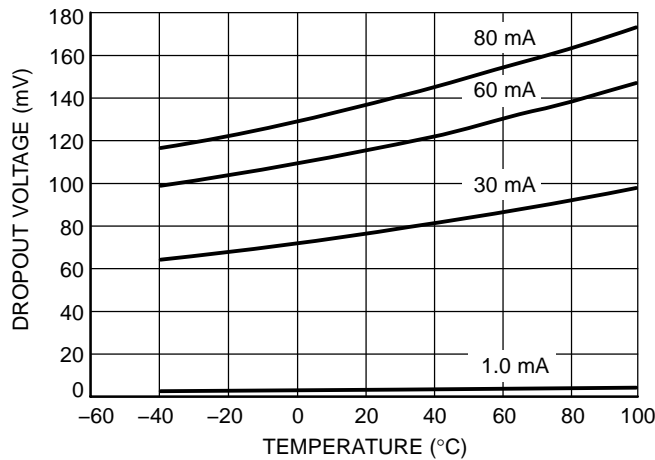

Figure 6. Dropout versus Temperature

## APPLICATION HINTS

### Input Decoupling

As with any regulator, it is necessary to reduce the dynamic impedance of the supply rail that feeds the component. A 1.0  $\mu\text{F}$  capacitor either ceramic or tantalum is recommended and should be connected close to the MC33761 package. Higher values will correspondingly improve the overall line transient response.

### Output Decoupling

Thanks to a novel concept, the MC33761 is a stable component and does not require any specific Equivalent Series Resistance (ESR) neither a minimum output current. Capacitors exhibiting ESRs ranging from a few  $\text{m}\Omega$  up to 3.0  $\Omega$  can thus safely be used. The minimum decoupling value is 1.0  $\mu\text{F}$  and can be augmented to fulfill stringent load transient requirements. The regulator accepts ceramic chip capacitors as well as tantalum devices.

### Noise Decoupling

Unlike other LDOs, the MC33761 is a true low-noise regulator. Without the need of an external bypass capacitor, it typically reaches the incredible level of 40  $\mu\text{VRMS}$  overall noise between 100 Hz and 100 kHz. To give maximum insight on noise specifications, ON Semiconductor includes spectral density graphics. The classical bypass capacitor impacts the start-up phase of standard LDOs. However, thanks to its low-noise architecture, the MC33761 operates without a bypass element and thus offers a typical 40  $\mu\text{s}$  start-up phase.

### Protections

The MC33761 hosts several protections, giving natural ruggedness and reliability to the products implementing the component. The output current is internally limited to a maximum value of 180 mA *typical* while temperature shutdown occurs if the die heats up beyond 125°C. These values let you assess the maximum differential voltage the device can sustain at a given output current before its protections come into play.

The maximum dissipation the package can handle is given by:

$$P_{\text{max}} = \frac{T_{\text{Jmax}} - T_{\text{A}}}{R_{\theta\text{JA}}}$$

If  $T_{\text{Jmax}}$  is limited to 125°C, then the MC33761 can dissipate up to 470 mW @ 25°C. The power dissipated by the MC33761 can be calculated from the following formula:

$$P_{\text{tot}} = \left( V_{\text{in}} \times I_{\text{gnd}}(I_{\text{out}}) \right) + \left( V_{\text{in}} - V_{\text{out}} \right) \times I_{\text{out}}$$

or

$$V_{\text{inmax}} = \frac{P_{\text{tot}} + V_{\text{out}} \times I_{\text{out}}}{I_{\text{gnd}} + I_{\text{out}}}$$

If a 80 mA output current is needed, the ground current is extracted from the data-sheet curves: 4.0 mA @ 80 mA. For a MC33761SNT1-28 (2.8 V) delivering 80 mA and operating at 25°C, the maximum input voltage will then be 8.3 V.

### Typical Applications

The following picture portrays the typical application of the MC33761.

# MC33761

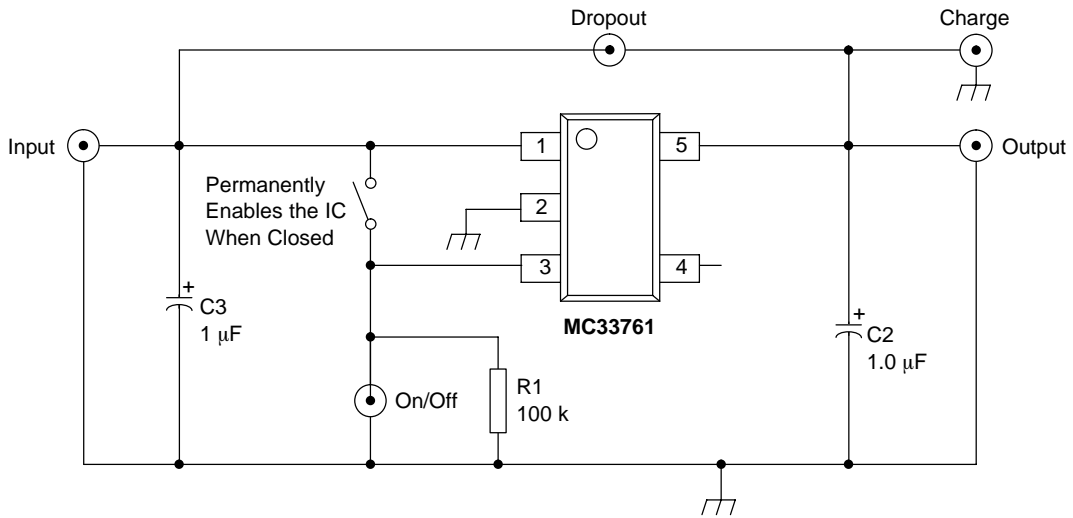

**Figure 7. A Typical Application Schematic**

As for any low noise designs, particular care has to be taken when tackling Printed Circuit Board (PCB) layout. The figure below gives an example of a layout where stray inductances/capacitances are minimized. This layout is the

basis for the MC33761 performance evaluation board. The BNC connectors give the user an easy and quick evaluation mean.

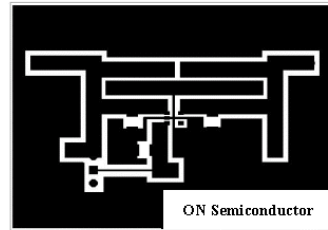
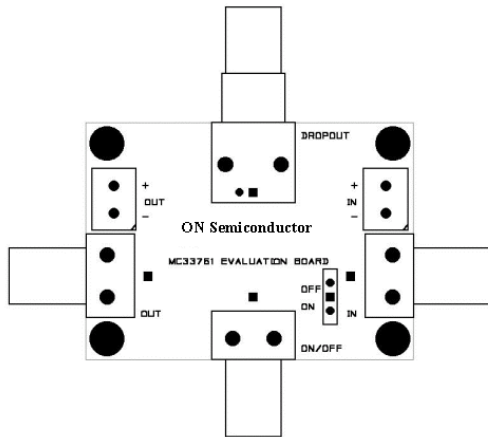

Understanding the Load Transient Improvement

The MC33761 features a novel architecture which allows the user to easily implement the regulator in burst systems where the time between two current shots is kept very small.

The quality of the transient response time is related to many parameters, among which the closed-loop bandwidth with the corresponding phase margin plays an important role. However, other characteristics also come into play like the series pass transistor saturation. When a current perturbation suddenly appears on the output, e.g. a load increase, the error amplifier reacts and actively biases the PNP transistor. During this reaction time, the LDO is in open-loop and the output impedance is rather high. As a result, the voltage brutally drops until the error amplifier effectively closes the loop and corrects the output error. When the load disappears, the opposite phenomenon takes place with a positive overshoot. The problem appears when this overshoot decays down to the LDO steady-state value.

During this decreasing phase, the LDO stops the PNP bias and one can consider the LDO asleep (Figure 8). If by misfortune a current shot appears, the reaction time is incredibly lengthened and a strong undershoot takes place. This reaction is clearly not acceptable for line sensitive devices, such as VCOs or other Radio-Frequency parts. This problem is dramatically exacerbated when the output current drops to zero rather than a few mA. In this later case, the internal feedback network is the only discharge path, accordingly lengthening the output voltage decay period (Figure 9).

The MC33761 cures this problem by implementing a clever design where the LDO detects the presence of the overshoot and forces the system to go back to steady-state as soon as possible, ready for the next shot. Figure 10 and 11 show how it positively improves the response time and decreases the negative peak voltage.

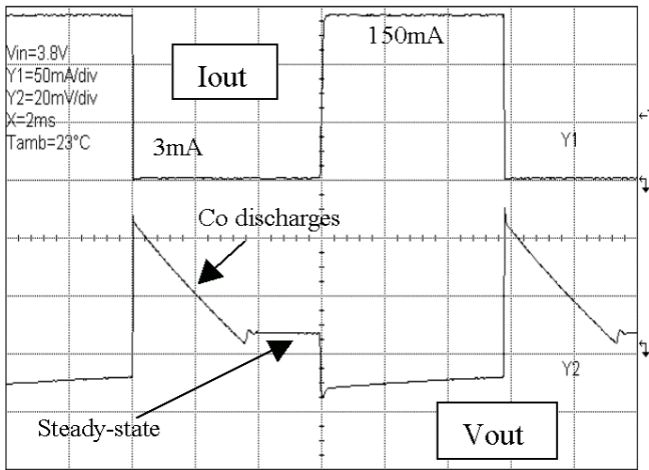

Figure 8. A Standard LDO Behavior when the Load Current Disappears

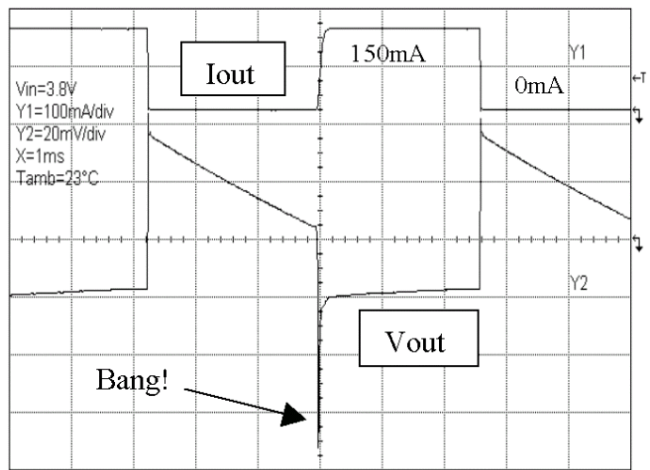

Figure 9. A Standard LDO Behavior when the Load Current Appears in the Decay Zone

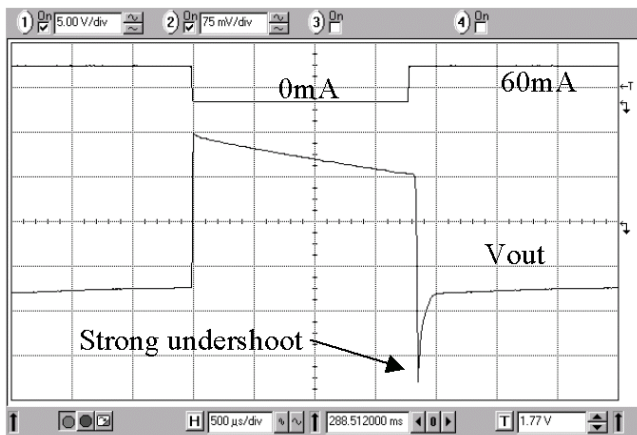

Figure 10. Without Load Transient Improvement

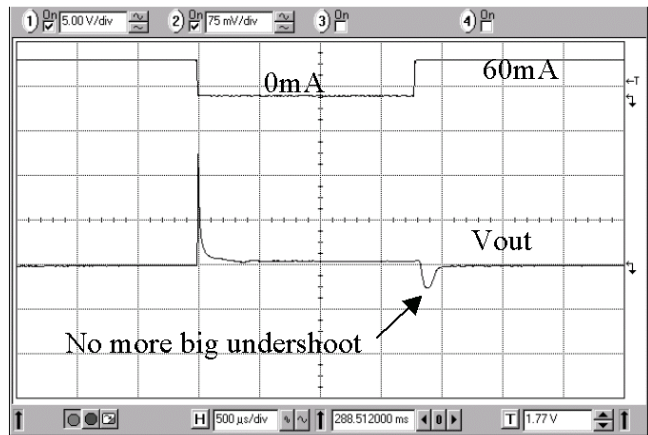

Figure 11. MC33761 with Load Transient Improvement

# MC33761

## MC33761 Has a Fast Start-Up Phase

Thanks to the lack of bypass capacitor the MC33761 is able to supply its downstream circuitry as soon as the OFF to ON signal appears. In a standard LDO, the charging time of the external bypass capacitor hampers the response time. A simple solution consists in suppressing this bypass element but, unfortunately, the noise rises to an

unacceptable level. MC33761 offers the best of both worlds since it no longer includes a bypass capacitor and starts in less than 40  $\mu\text{s}$  typically (Repetitive at 200 Hz). It also ensures a low-noise level of 40  $\mu\text{VRMS}$  100 Hz–100 kHz. The following picture details the typical 33761 start-up phase.

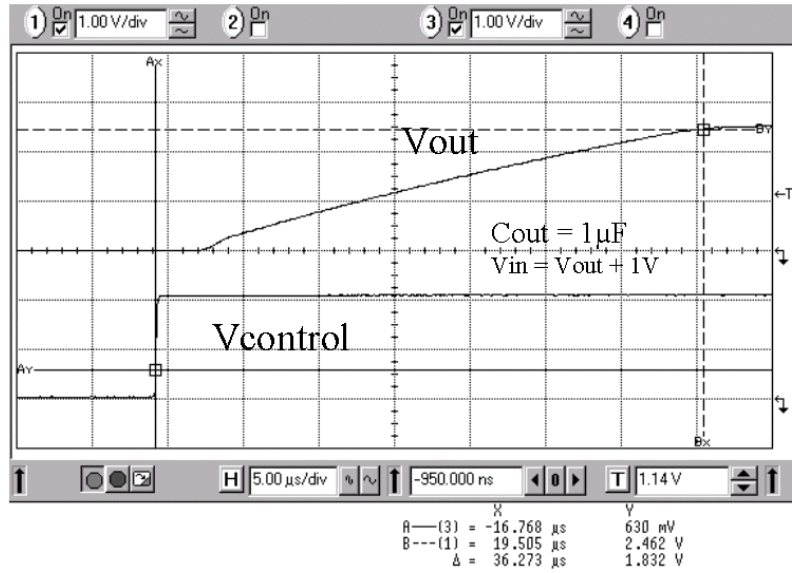

Figure 12. Repetitive Start-Up Waveforms

TYPICAL TRANSIENT RESPONSES

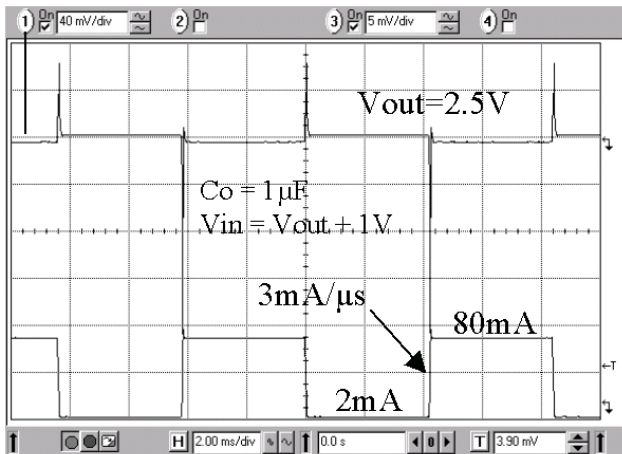

Figure 13. Output is Pulsed from 2.0 mA to 80 mA

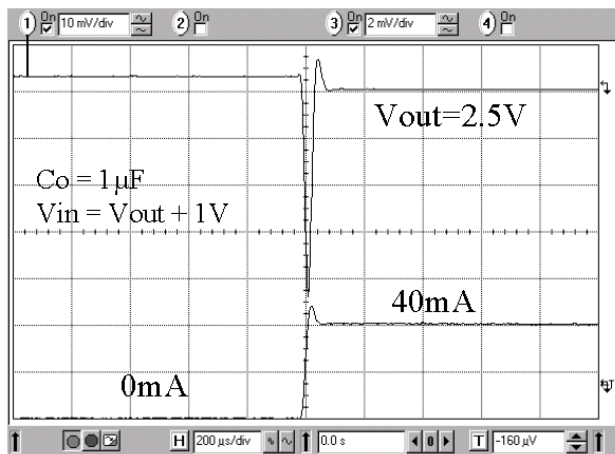

Figure 14. Discharge Effects from 0 to 40 mA

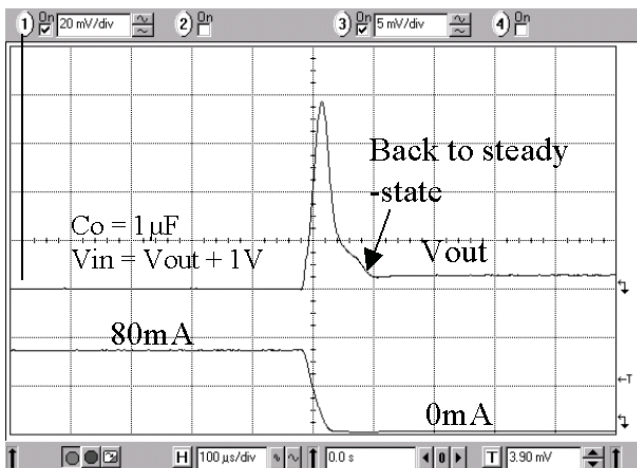

Figure 15. Load Transient Improvement Effect

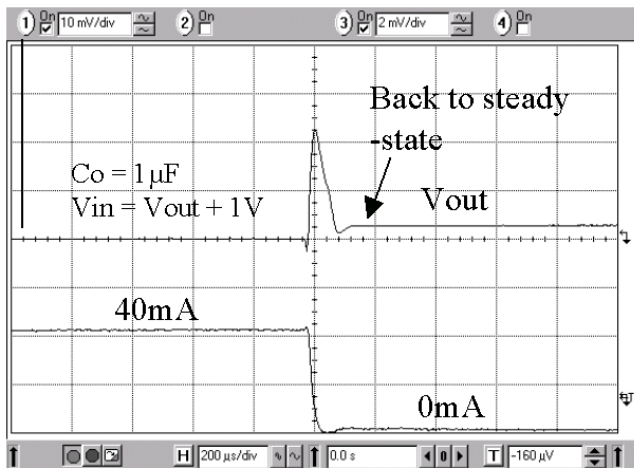

Figure 16. Load Transient Improvement Effect

# MC33761

## TYPICAL TRANSIENT RESPONSES

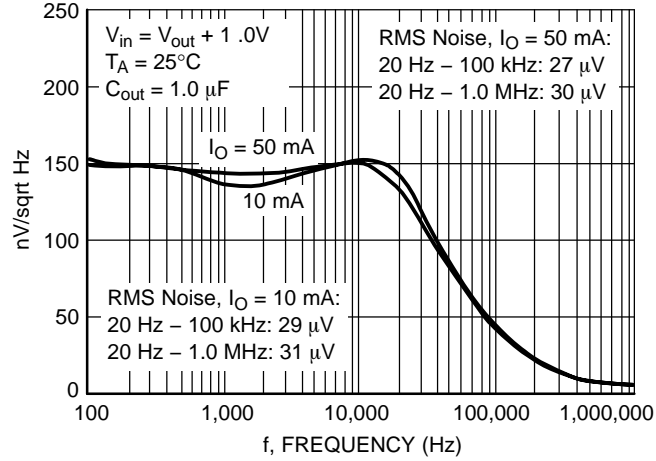

Figure 17. MC33761 Typical Noise Density Performance

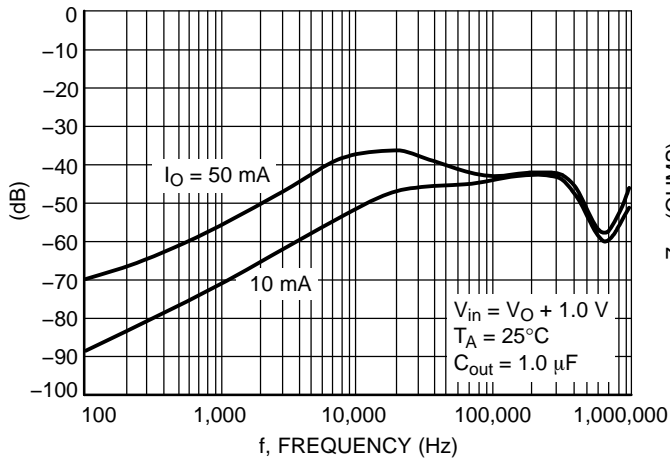

Figure 18. MC33761 Typical Ripple Rejection Performance

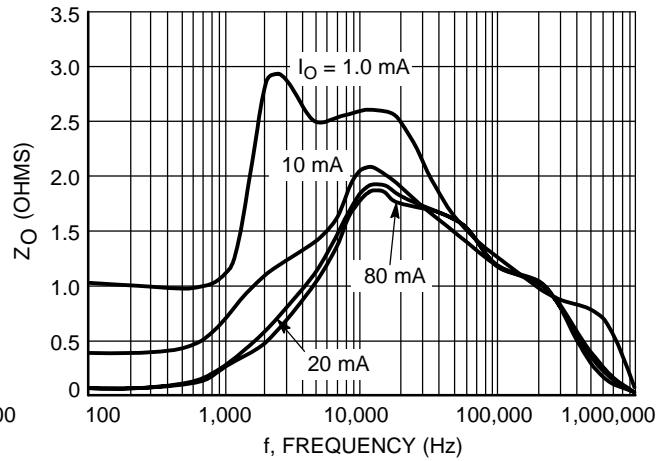

Figure 19. Typical Output Impedance plot  
 $C_{out} = 1.0 \mu F$ ,  $V_{in} = V_{out} + 1.0$

# MC33761

## ORDERING INFORMATION

Device	Specific Marking Code	Voltage Output	Package	Shipping†
MC33761SNT1-025	L25	2.5 V	Thin SOT-23-5	3000 / Tape & Reel
MC33761SNT1-025G			Thin SOT-23-5 (Pb-Free)	
MC33761SNT1-028	L28	2.8 V	Thin SOT-23-5	
MC33761SNT1-028G			Thin SOT-23-5 (Pb-Free)	
MC33761SNT1-029	L29	2.9 V	Thin SOT-23-5	
MC33761SNT1-029G			Thin SOT-23-5 (Pb-Free)	
MC33761SNT1-030	L30	3.0 V	Thin SOT-23-5	
MC33761SNT1-030G			Thin SOT-23-5 (Pb-Free)	
MC33761SNT1-050	L50	5.0 V	Thin SOT-23-5	
MC33761SNT1-050G			Thin SOT-23-5 (Pb-Free)	

†For information on tape and reel specifications, including part orientation and tape sizes, please refer to our Tape and Reel Packaging Specifications Brochure, BRD8011/D

# MC33761

## PACKAGE DIMENSIONS

### TSOP-5 CASE 483-02 ISSUE F

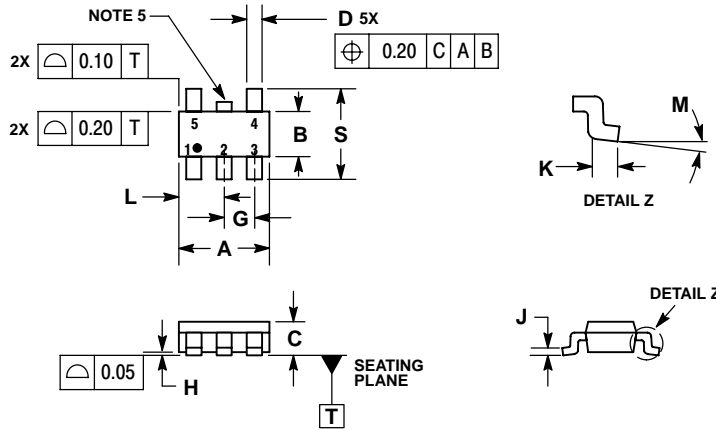

**NOTES:**

1. DIMENSIONING AND TOLERANCING PER ASME Y14.5M, 1994.
2. CONTROLLING DIMENSION: MILLIMETERS.
3. MAXIMUM LEAD THICKNESS INCLUDES LEAD FINISH THICKNESS. MINIMUM LEAD THICKNESS IS THE MINIMUM THICKNESS OF BASE MATERIAL.
4. DIMENSIONS A AND B DO NOT INCLUDE MOLD FLASH, PROTRUSIONS, OR GATE BURRS.
5. OPTIONAL CONSTRUCTION: AN ADDITIONAL TRIMMED LEAD IS ALLOWED IN THIS LOCATION. TRIMMED LEAD NOT TO EXTEND MORE THAN 0.2 FROM BODY.

DIM	MILLIMETERS	
	MIN	MAX
A	3.00 BSC	
B	1.50 BSC	
C	0.90	1.10
D	0.25	0.50
G	0.95 BSC	
H	0.01	0.10
J	0.10	0.26
K	0.20	0.60
L	1.25	1.55
M	0 °	10 °
S	2.50	3.00

### SOLDERING FOOTPRINT\*

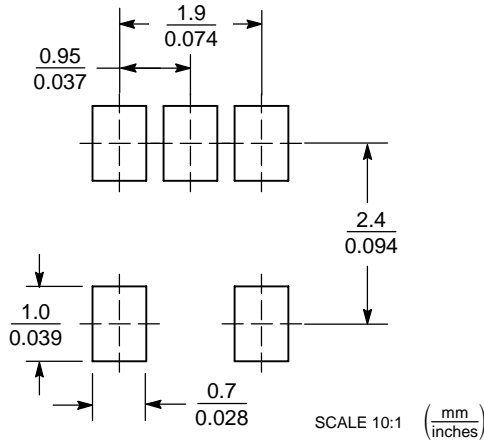

\*For additional information on our Pb-Free strategy and soldering details, please download the ON Semiconductor Soldering and Mounting Techniques Reference Manual, SOLDERRM/D.

ON Semiconductor and are registered trademarks of Semiconductor Components Industries, LLC (SCILLC). SCILLC reserves the right to make changes without further notice to any products herein. SCILLC makes no warranty, representation or guarantee regarding the suitability of its products for any particular purpose, nor does SCILLC assume any liability arising out of the application or use of any product or circuit, and specifically disclaims any and all liability, including without limitation special, consequential or incidental damages. "Typical" parameters which may be provided in SCILLC data sheets and/or specifications can and do vary in different applications and actual performance may vary over time. All operating parameters, including "Typicals" must be validated for each customer application by customer's technical experts. SCILLC does not convey any license under its patent rights nor the rights of others. SCILLC products are not designed, intended, or authorized for use as components in systems intended for surgical implant into the body, or other applications intended to support or sustain life, or for any other application in which the failure of the SCILLC product could create a situation where personal injury or death may occur. Should Buyer purchase or use SCILLC products for any such unintended or unauthorized application, Buyer shall indemnify and hold SCILLC and its officers, employees, subsidiaries, affiliates, and distributors harmless against all claims, costs, damages, and expenses, and reasonable attorney fees arising out of, directly or indirectly, any claim of personal injury or death associated with such unintended or unauthorized use, even if such claim alleges that SCILLC was negligent regarding the design or manufacture of the part. SCILLC is an Equal Opportunity/Affirmative Action Employer. This literature is subject to all applicable copyright laws and is not for resale in any manner.

### PUBLICATION ORDERING INFORMATION

**LITERATURE FULFILLMENT:**  
Literature Distribution Center for ON Semiconductor  
P.O. Box 5163, Denver, Colorado 80217 USA  
**Phone:** 303-675-2175 or 800-344-3860 Toll Free USA/Canada  
**Fax:** 303-675-2176 or 800-344-3867 Toll Free USA/Canada  
**Email:** orderlit@onsemi.com

**N. American Technical Support:** 800-282-9855 Toll Free  
USA/Canada

**Japan:** ON Semiconductor, Japan Customer Focus Center  
2-9-1 Kamimeguro, Meguro-ku, Tokyo, Japan 153-0051  
**Phone:** 81-3-5773-3850

**ON Semiconductor Website:** <http://onsemi.com>

**Order Literature:** <http://www.onsemi.com/litorder>

For additional information, please contact your local Sales Representative.

## Looking for pricing, stock, or lifecycle information?

Click below to explore more details on WIN SOURCE:

 [View MC33761SNT1-028G on WIN SOURCE](#)

 [ON Semiconductor](#) Information

## Optimize Your Supply Chain with WIN SOURCE Solutions

-  Global Sourcing Solution
-  Obsolete Management
-  Cost Control Management
-  Shortage Management
-  Alternative Solution
-  Excess Inventory Management