

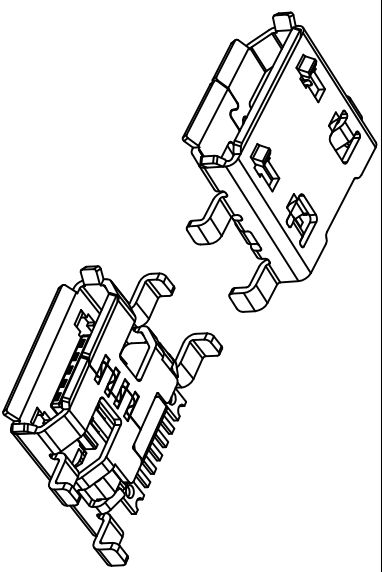

**THE DATASHEET OF  
10103593-0001LF**





- NOTE-
1. This product is enable to mount both USB-IF Recommended PCB pattern
  2. Coplanarity : The damension between flat tool and bottom of soldering terminals when connector put on the flat tool like PCB Signal terminal / Metal tail (front) : Max 0.08 mm
  3. PRODUCT NUMBERINGS:  
10103593 - 0001LF

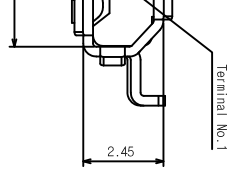
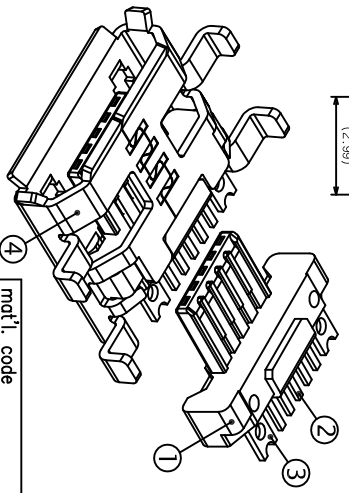
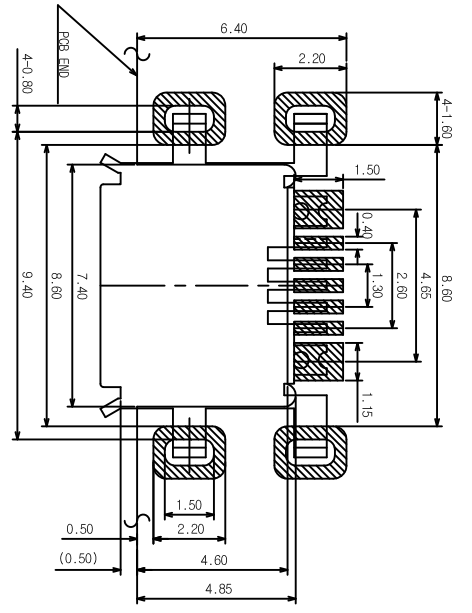
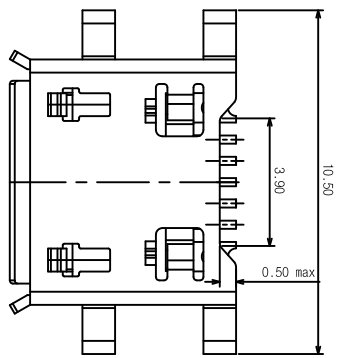
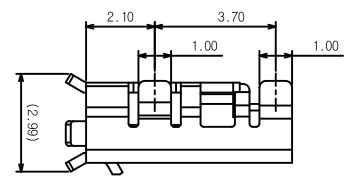
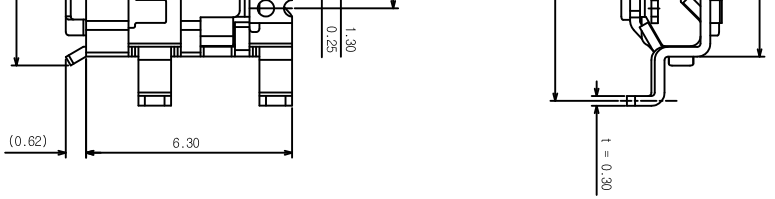

mat'l. code		tolerances unless otherwise specified		CUSTOMER COPY		FCI	
ltr	ecn no	dr	date	linear	projection	title	www.fciconnect.com
A	T10-0002	JH	1/7/10	.XX ± 0.25 .XXX ± 0.15 0° ± 2°	MM	MICRO-USB B-TYPE MID-MOUNT	
				anglcs	MM	product family	USB
				dr	JASON HSU	size dwg no	10103593
				enfr	JASON HSU	code	TWIN
				chr	GARY HSEH	sheet	1 of 1
				apprd	JOSEPH HSA		



Material		Finish	
Plastic (Back)	UL94V-0	Au over Ni	
alloy		Au over Ni	
Stainless Steel		Ni plated	

sheet index	revision	sheet	revision	sheet
1	A	1		

USB-IF REVERSE type Pattern  
 USB-IF Recommended RIVERSE type Pattern  
 (Tolerance : ±0.05)

## Looking for pricing, stock, or lifecycle information?

Click below to explore more details on WIN SOURCE:

-  [View 10103593-0001LF on WIN SOURCE](#)
-  [Amphenol FCI Information](#)

## Optimize Your Supply Chain with WIN SOURCE Solutions

-  Global Sourcing Solution
-  Obsolete Management
-  Cost Control Management
-  Shortage Management
-  Alternative Solution
-  Excess Inventory Management