

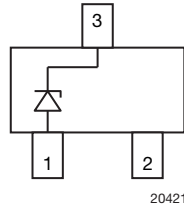

**THE DATASHEET OF
BZX84C36-E3-08**

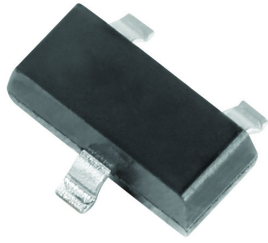

Small Signal Zener Diodes

DESIGN SUPPORT TOOLS
[click logo to get started](#)

FEATURES

- Silicon planar Zener diodes
- The Zener voltages are graded according to the international E24 standard. Standard Zener voltage tolerance is $\pm 5\%$, indicated by the "C" in the ordering code. Replace "C" with "B" for $\pm 2\%$ tolerance.
- AEC-Q101 qualified available
- ESD capability acc. to AEC-Q101:
human body model: $> 8\text{ kV}$,
machine model: $> 800\text{ V}$
- Base P/N-E3 - RoHS-compliant, commercial grade
- Base P/N-HE3 - RoHS-compliant, AEC-Q101 qualified
- Material categorization: for definitions of compliance please see www.vishay.com/doc?99912



PRIMARY CHARACTERISTICS		
PARAMETER	VALUE	UNIT
V_Z range nom.	2.4 to 75	V
Test current I_{ZT}	2; 5	mA
V_Z specification	Pulse current	
Circuit configuration	Single	

ORDERING INFORMATION			
DEVICE NAME	ORDERING CODE	TAPED UNITS PER REEL	MINIMUM ORDER QUANTITY
BZX84-series	BZX84C2V4-E3-08 to BZX84C75-E3-08	3000 (8 mm tape on 7" reel)	15 000
	BZX84B2V4-E3-08 to BZX84B75-E3-08		
	BZX84C2V4-HE3-08 to BZX84C75-HE3-08		
	BZX84B2V4-HE3-08 to BZX84B75-HE3-08		
	BZX84C2V4-E3-18 to BZX84C75-E3-18	10 000 (8 mm tape on 13" reel)	10 000
	BZX84B2V4-E3-18 to BZX84B75-E3-18		
	BZX84C2V4-HE3-18 to BZX84C75-HE3-18		
	BZX84B2V4-HE3-18 to BZX84B75-HE3-18		

PACKAGE				
PACKAGE NAME	WEIGHT	MOLDING COMPOUND FLAMMABILITY RATING	MOISTURE SENSITIVITY LEVEL	SOLDERING CONDITIONS
SOT-23	8.8 mg	UL 94 V-0	MSL level 1 (according J-STD-020)	260 °C/10 s at terminals

ABSOLUTE MAXIMUM RATINGS					
PARAMETER	TEST CONDITION	SYMBOL	VALUE	UNIT	
Power dissipation	$T_{amb} = 25\text{ °C}$, device on fiberglass substrate, acc. layout on page 7	P_{tot}	300	mW	
Thermal resistance junction to ambient air	$T_{amb} = 25\text{ °C}$, device on fiberglass substrate, acc. layout on page 7	R_{thJA}	420	K/W	
Junction temperature		T_j	150	°C	
Storage temperature range		T_{stg}	-65 to +150	°C	
Operating temperature range		T_{op}	-55 to +150	°C	



ELECTRICAL CHARACTERISTICS ($T_{amb} = 25\text{ }^{\circ}\text{C}$, unless otherwise specified)												
PART NUMBER	MARKING CODE	ZENER VOLTAGE RANGE			TEST CURRENT		REVERSE LEAKAGE CURRENT		DYNAMIC RESISTANCE $f = 1\text{ kHz}$		TEMPERATURE COEFFICIENT	
		V_Z at I_{ZT1}			I_{ZT1}	I_{ZT2}	I_R at V_R		Z_Z at I_{ZT1}	Z_{ZK} at I_{ZT2}	α_{VZ} at I_{ZT1}	
		V			mA		μA	V	Ω		$10^{-4}/^{\circ}\text{C}$	
		MIN.	NOM.	MAX.					MAX.	MAX.	MIN.	MAX.
BZX84C2V4	Z11	2.2	2.4	2.6	5	1	50	1	100	275	-9	-4
BZX84C2V7	Z12	2.5	2.7	2.9	5	1	20	1	100	600	-9	-4
BZX84C3V0	Z13	2.8	3.0	3.2	5	1	10	1	95	600	-9	-3
BZX84C3V3	Z14	3.1	3.3	3.5	5	1	5	1	95	600	-8	-3
BZX84C3V6	Z15	3.4	3.6	3.8	5	1	5	1	90	600	-8	-3
BZX84C3V9	Z16	3.7	3.9	4.1	5	1	3	1	90	600	-7	-3
BZX84C4V3	Z17	4.0	4.3	4.6	5	1	3	1	90	600	-6	-1
BZX84C4V7	Z1	4.4	4.7	5.0	5	1	3	2	80	500	-5	2
BZX84C5V1	Z2	4.8	5.1	5.4	5	1	2	2	60	480	-3	4
BZX84C5V6	Z3	5.2	5.6	6.0	5	1	1	2	40	400	-2	6
BZX84C6V2	Z4	5.8	6.2	6.6	5	1	3	4	10	150	-1	7
BZX84C6V8	Z5	6.4	6.8	7.2	5	1	2	4	15	80	2	7
BZX84C7V5	Z6	7.0	7.5	7.9	5	1	1	5	15	80	3	7
BZX84C8V2	Z7	7.7	8.2	8.7	5	1	0.7	5	15	80	4	7
BZX84C9V1	Z8	8.5	9.1	9.6	5	1	0.5	6	15	100	5	8
BZX84C10	Z9	9.4	10	10.6	5	1	0.2	7	20	150	5	8
BZX84C11	Y1	10.4	11	11.6	5	1	0.1	8	20	150	5	9
BZX84C12	Y2	11.4	12	12.7	5	1	0.1	8	25	150	6	9
BZX84C13	Y3	12.4	13	14.1	5	1	0.1	8	30	170	7	9
BZX84C15	Y4	13.8	15	15.6	5	1	0.05	10.5	30	200	7	9
BZX84C16	Y5	15.3	16	17.1	5	1	0.05	11.2	40	200	8	9.5
BZX84C18	Y6	16.8	18	19.1	5	1	0.05	12.6	45	225	8	9.5
BZX84C20	Y7	18.8	20	21.2	5	1	0.05	14.0	55	225	8	10
BZX84C22	Y8	20.8	22	23.3	5	1	0.05	15.4	55	250	8	10
BZX84C24	Y9	22.8	24	25.6	5	1	0.05	16.8	70	250	8	10
BZX84C27	Y10	25.1	27	28.9	2	0.5	0.05	18.9	80	300	8	10
BZX84C30	Y11	28	30	32	2	0.5	0.05	21.0	80	300	8	10
BZX84C33	Y12	31	33	35	2	0.5	0.05	23.1	80	325	8	10
BZX84C36	Y13	34	36	38	2	0.5	0.05	25.2	90	350	8	10
BZX84C39	Y14	37	39	41	2	0.5	0.05	27.3	130	350	10	12
BZX84C43	Y15	40	43	46	2	0.5	0.05	30.1	150	375	10	12
BZX84C47	Y16	44	47	50	2	0.5	0.05	32.9	170	375	10	12
BZX84C51	Y17	48	51	54	2	0.5	0.05	35.7	180	400	10	12
BZX84C56	Y18	52	56	60	2	0.5	0.05	39.2	200	425	9	11
BZX84C62	Y19	58	62	66	2	0.5	0.05	43.4	215	450	9	12
BZX84C68	Y20	64	68	72	2	0.5	0.05	47.6	240	475	10	12
BZX84C75	Y21	70	75	79	2	0.5	0.05	52.5	255	500	10	12



ELECTRICAL CHARACTERISTICS ($T_{amb} = 25\text{ }^{\circ}\text{C}$, unless otherwise specified)												
PART NUMBER	MARKING CODE	ZENER VOLTAGE RANGE			TEST CURRENT		REVERSE LEAKAGE CURRENT		DYNAMIC RESISTANCE $f = 1\text{ kHz}$		TEMPERATURE COEFFICIENT	
		V_Z at I_{ZT1}			I_{ZT1}	I_{ZT2}	I_R at V_R		Z_Z at I_{ZT1}	Z_{ZK} at I_{ZT2}	α_{VZ} at I_{ZT1}	
		V			mA		μA	V	Ω		$10^{-4}/^{\circ}\text{C}$	
		MIN.	NOM.	MAX.					MAX.	MAX.	MIN.	MAX.
BZX84B2V4	Z50	2.35	2.4	2.45	5	1	50	1	100	275	-9	-4
BZX84B2V7	Z51	2.65	2.7	2.75	5	1	20	1	100	600	-9	-4
BZX84B3V0	Z52	2.94	3.0	3.06	5	1	10	1	95	600	-9	-3
BZX84B3V3	Z53	3.23	3.3	3.37	5	1	5	1	95	600	-8	-3
BZX84B3V6	Z54	3.53	3.6	3.67	5	1	5	1	90	600	-8	-3
BZX84B3V9	Z55	3.82	3.9	3.98	5	1	3	1	90	600	-7	-3
BZX84B4V3	Z56	4.21	4.3	4.39	5	1	3	1	90	600	-6	-1
BZX84B4V7	Z57	4.61	4.7	4.79	5	1	3	2	80	500	-5	2
BZX84B5V1	Z58	5.0	5.1	5.2	5	1	2	2	60	480	-3	4
BZX84B5V6	Z59	5.49	5.6	5.71	5	1	1	2	40	400	-2	6
BZX84B6V2	Z60	6.08	6.2	6.32	5	1	3	4	10	150	-1	7
BZX84B6V8	Z61	6.66	6.8	6.94	5	1	2	4	15	80	2	7
BZX84B7V5	Z62	7.35	7.5	7.65	5	1	1	5	15	80	3	7
BZX84B8V2	Z63	8.04	8.2	8.36	5	1	0.7	5	15	80	4	7
BZX84B9V1	Z64	8.92	9.1	9.28	5	1	0.5	6	15	100	5	8
BZX84B10	Z65	9.8	10	10.2	5	1	0.2	7	20	150	5	8
BZX84B11	Z66	10.8	11	11.2	5	1	0.1	8	20	150	5	9
BZX84B12	Z67	11.8	12	12.2	5	1	0.1	8	25	150	6	9
BZX84B13	Z68	12.7	13	13.3	5	1	0.1	8	30	170	7	9
BZX84B15	Z69	14.7	15	15.3	5	1	0.05	10.5	30	200	7	9
BZX84B16	Z70	15.7	16	16.3	5	1	0.05	11.2	40	200	8	9.5
BZX84B18	Z71	17.6	18	18.4	5	1	0.05	12.6	45	225	8	9.5
BZX84B20	Z72	19.6	20	20.4	5	1	0.05	14	55	225	8	10
BZX84B22	Z73	21.6	22	22.4	5	1	0.05	15.4	55	250	8	10
BZX84B24	Z74	23.5	24	24.5	5	1	0.05	16.8	70	250	8	10
BZX84B27	Z75	26.5	27	27.5	2	0.5	0.05	18.9	80	300	8	10
BZX84B30	Z76	29.4	30	30.6	2	0.5	0.05	21	80	300	8	10
BZX84B33	Z77	32.3	33	33.7	2	0.5	0.05	23.1	80	325	8	10
BZX84B36	Z78	35.3	36	36.7	2	0.5	0.05	25.2	90	350	8	10
BZX84B39	Z79	38.2	39	39.8	2	0.5	0.05	27.3	130	350	10	12
BZX84B43	Z80	42.1	43	43.9	2	0.5	0.05	30.1	150	375	10	12
BZX84B47	Z81	46.1	47	47.9	2	0.5	0.05	32.9	170	375	10	12
BZX84B51	Z82	50	51	52	2	0.5	0.05	35.7	180	400	10	12
BZX84B56	Z83	54.9	56	57.1	2	0.5	0.05	39.2	200	425	9	11
BZX84B62	Z84	60.8	62	63.2	2	0.5	0.05	43.4	215	450	9	12
BZX84B68	Z85	66.6	68	69.4	2	0.5	0.05	47.6	240	475	10	12
BZX84B75	Z86	73.5	75	76.5	2	0.5	0.05	52.5	255	500	10	12

TYPICAL CHARACTERISTICS ($T_{amb} = 25\text{ }^{\circ}\text{C}$, unless otherwise specified)

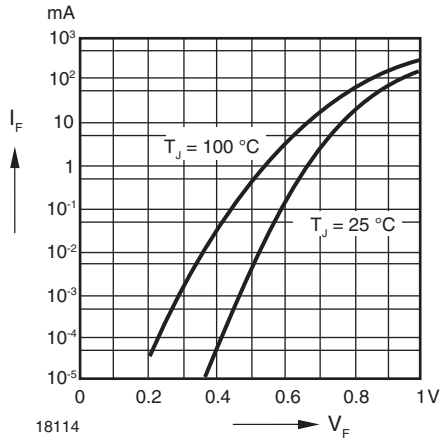

Fig. 1 - Forward Characteristics

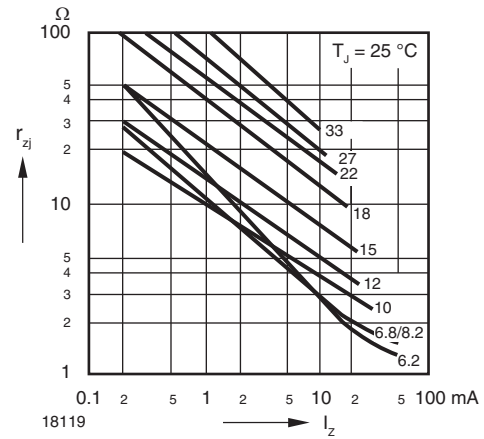

Fig. 4 - Dynamic Resistance vs. Zener Current

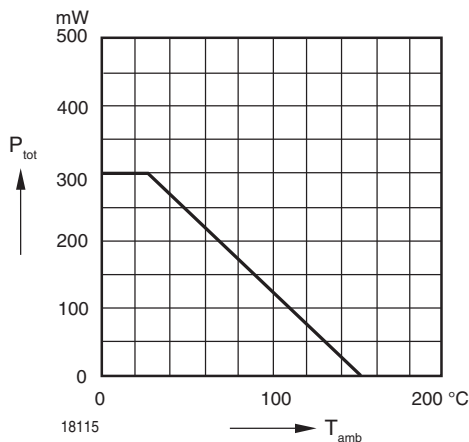

Fig. 2 - Admissible Power Dissipation vs. Ambient Temperature

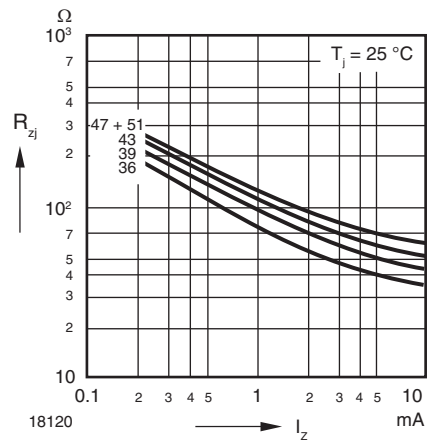

Fig. 5 - Dynamic Resistance vs. Zener Current

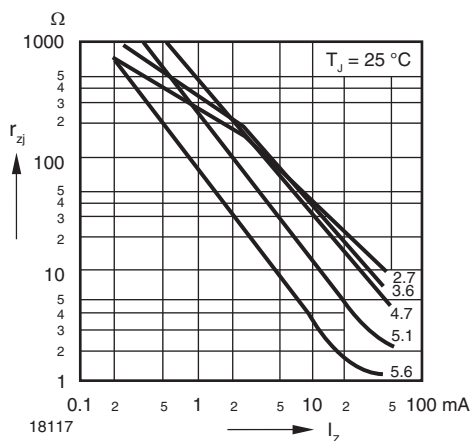

Fig. 3 - Dynamic Resistance vs. Zener Current

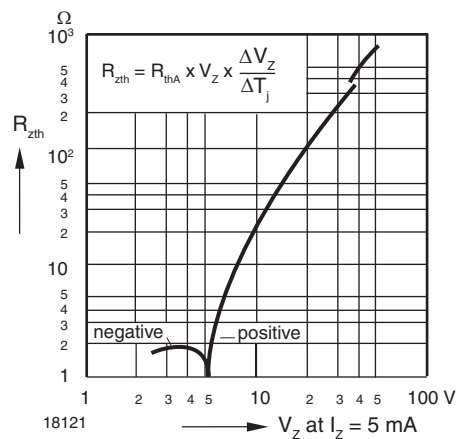

Fig. 6 - Thermal Differential Resistance vs. Zener Voltage

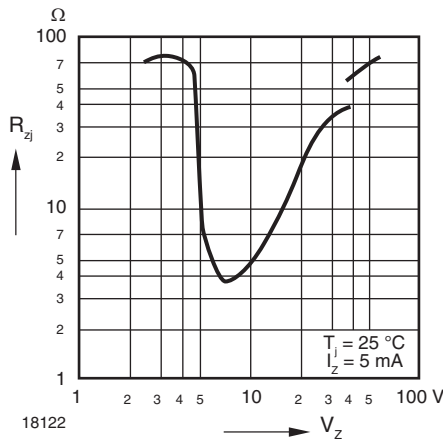

Fig. 7 - Dynamic Resistance vs. Zener Voltage

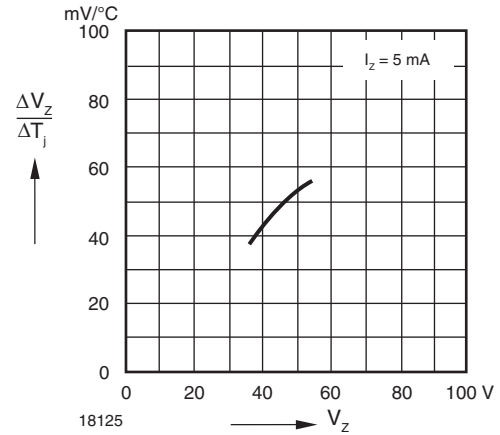

Fig. 10 - Temperature Dependence of Zener Voltage vs. Zener Voltage

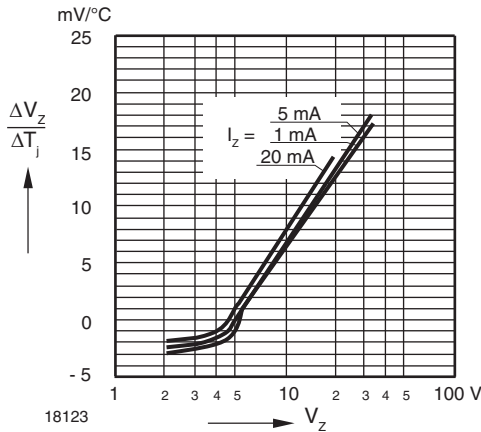

Fig. 8 - Temperature Dependence of Zener Voltage vs. Zener Voltage

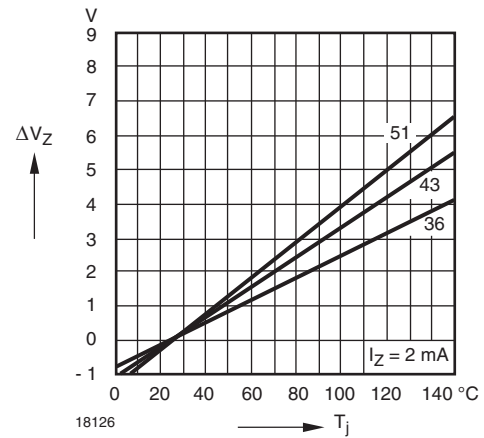

Fig. 11 - Change of Zener Voltage vs. Junction Temperature

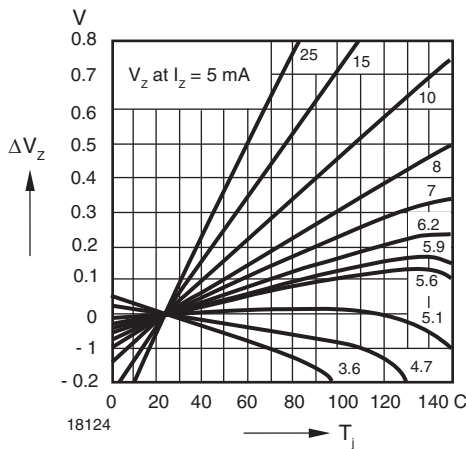

Fig. 9 - Change of Zener Voltage vs. Junction Temperature

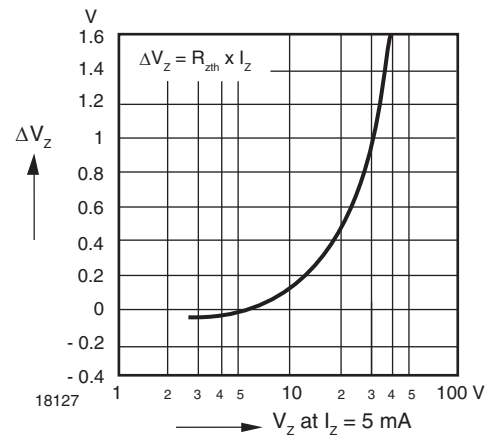

Fig. 12 - Change of Zener Voltage from Turn-on up to the Point of Thermal Equilibrium vs. Zener Voltage

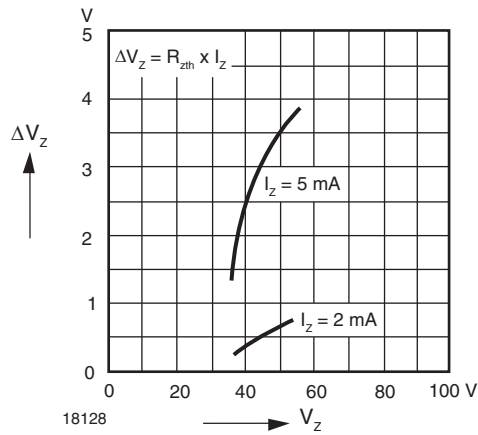

Fig. 13 - Change of Zener Voltage from Turn-on up to the Point of Thermal Equilibrium vs. Zener Voltage

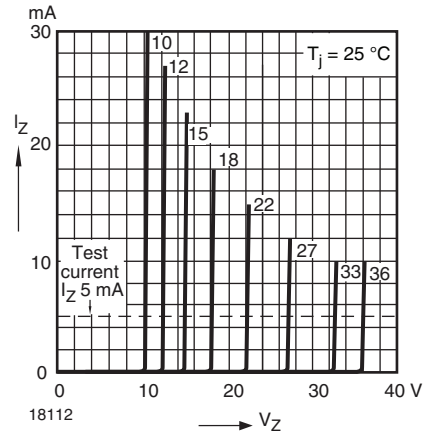

Fig. 15 - Breakdown Characteristics

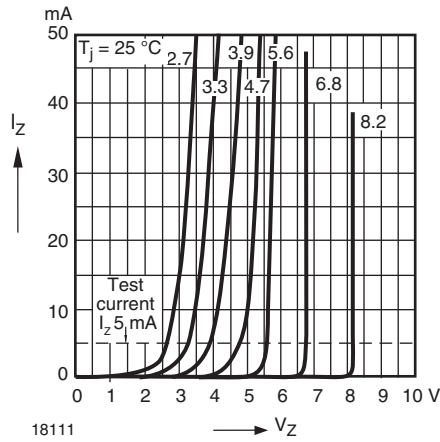

Fig. 14 - Breakdown Characteristics

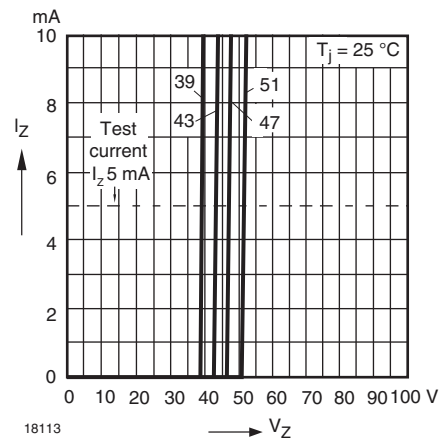
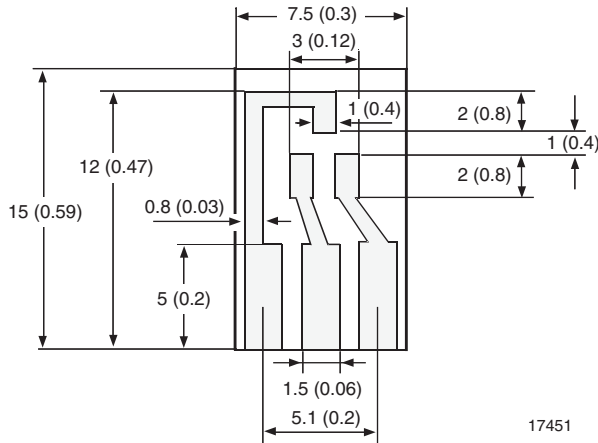

Fig. 16 - Breakdown Characteristics



LAYOUT FOR R_{thJA} TEST

Thickness: fiberglass 0.059" (1.5 mm)
Copper leads 0.012" (0.3 mm)



17451

PACKAGE DIMENSIONS in millimeters (inches): SOT-23

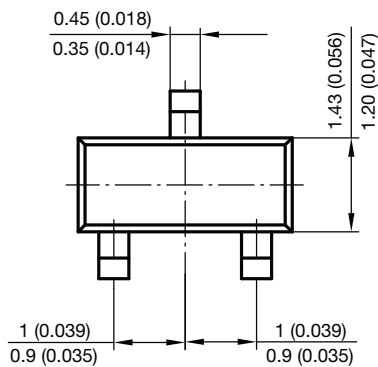
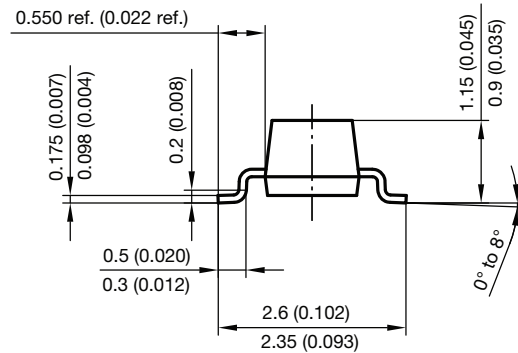
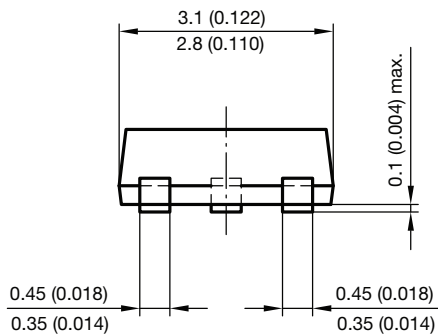

Foot print recommendation:

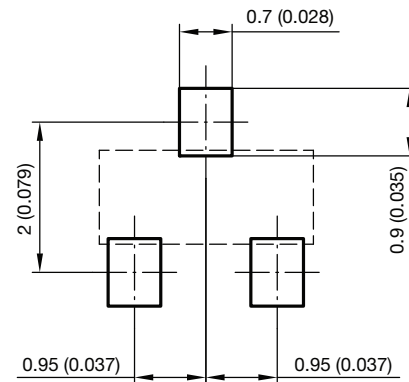

Document no.: 6.541-5014.01-4
Rev. 8 - Date: 23. Sep. 2009
17418



Disclaimer

ALL PRODUCT, PRODUCT SPECIFICATIONS AND DATA ARE SUBJECT TO CHANGE WITHOUT NOTICE TO IMPROVE RELIABILITY, FUNCTION OR DESIGN OR OTHERWISE.

Vishay Intertechnology, Inc., its affiliates, agents, and employees, and all persons acting on its or their behalf (collectively, "Vishay"), disclaim any and all liability for any errors, inaccuracies or incompleteness contained in any datasheet or in any other disclosure relating to any product.

Vishay makes no warranty, representation or guarantee regarding the suitability of the products for any particular purpose or the continuing production of any product. To the maximum extent permitted by applicable law, Vishay disclaims (i) any and all liability arising out of the application or use of any product, (ii) any and all liability, including without limitation special, consequential or incidental damages, and (iii) any and all implied warranties, including warranties of fitness for particular purpose, non-infringement and merchantability.

Statements regarding the suitability of products for certain types of applications are based on Vishay's knowledge of typical requirements that are often placed on Vishay products in generic applications. Such statements are not binding statements about the suitability of products for a particular application. It is the customer's responsibility to validate that a particular product with the properties described in the product specification is suitable for use in a particular application. Parameters provided in datasheets and / or specifications may vary in different applications and performance may vary over time. All operating parameters, including typical parameters, must be validated for each customer application by the customer's technical experts. Product specifications do not expand or otherwise modify Vishay's terms and conditions of purchase, including but not limited to the warranty expressed therein.

Except as expressly indicated in writing, Vishay products are not designed for use in medical, life-saving, or life-sustaining applications or for any other application in which the failure of the Vishay product could result in personal injury or death. Customers using or selling Vishay products not expressly indicated for use in such applications do so at their own risk. Please contact authorized Vishay personnel to obtain written terms and conditions regarding products designed for such applications.

No license, express or implied, by estoppel or otherwise, to any intellectual property rights is granted by this document or by any conduct of Vishay. Product names and markings noted herein may be trademarks of their respective owners.

Looking for pricing, stock, or lifecycle information?

Click below to explore more details on WIN SOURCE:

 [View BZX84C36-E3-08 on WIN SOURCE](#)

 [Vishay Information](#)

Optimize Your Supply Chain with WIN SOURCE Solutions

-  Global Sourcing Solution
-  Obsolete Management
-  Cost Control Management
-  Shortage Management
-  Alternative Solution
-  Excess Inventory Management