



# Photointerrupter Product Data Sheet

LTH-301-05

Spec No.: DS-55-92-0002

Effective Date: 06/29/2000

Revision: -

**LITE-ON DCC**

**RELEASE**

BNS-OD-FC001/A4

## FEATURES

- \* NON-CONTACT SWITCHING.
- \* FOR DIRECT PC BOARD OR DUAL-IN-LINE SOCKET MOUNTING.
- \* FAST SWITCHING SPEED.

## PACKAGE DIMENSIONS

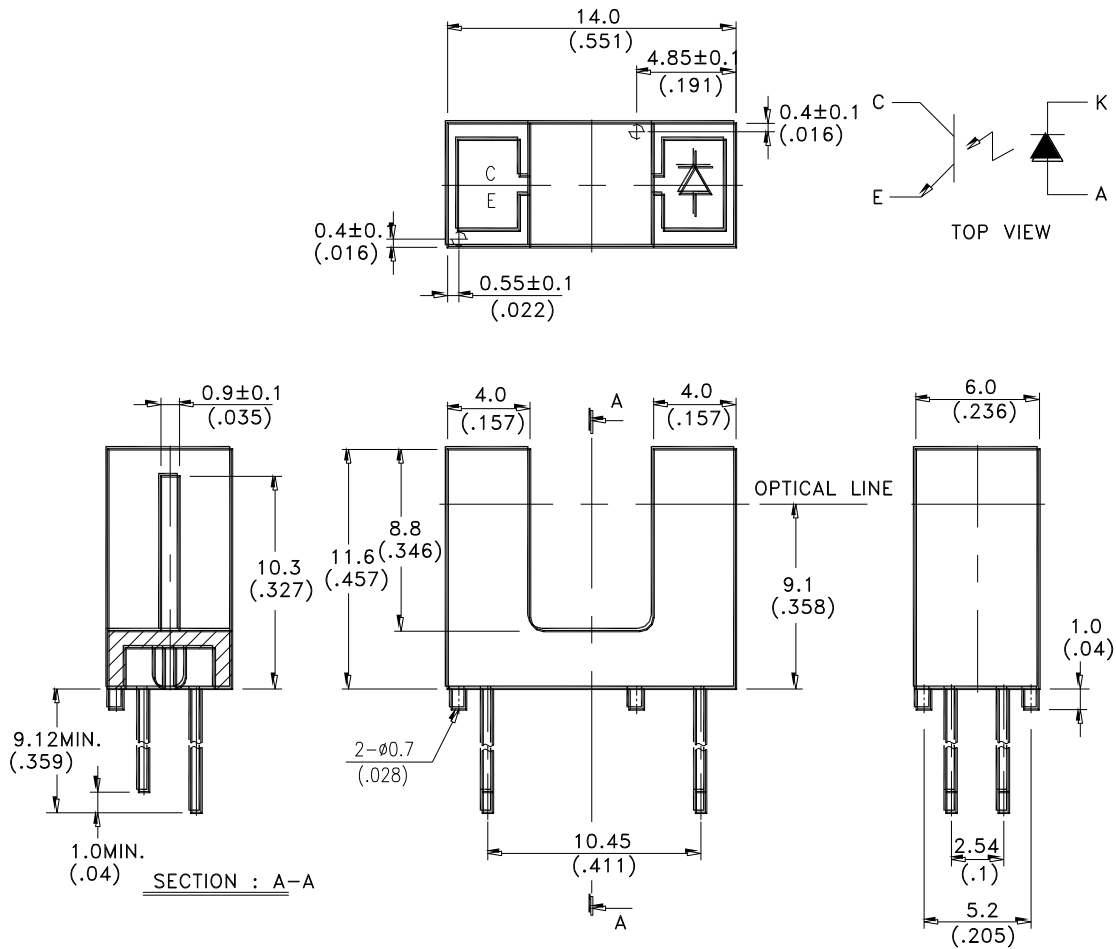

## NOTES:

1. All dimensions are in millimeters (inches).
2. Tolerance is ±0.25mm(.010") unless otherwise noted.

## ABSOLUTE MAXIMUM RATINGS AT T<sub>A</sub>=25°C

PARAMETER	MAXIMUM RATING	UNIT
IR Diode Continuous Forward Current	60	mA
IR Diode Reverse Voltage	5	V
Transistor Collector Current	20	mA
Transistor Power Dissipation	75	mW
IR Diode Peak Forward Current (Pulse Wide = 10 $\mu$ S, 300 pps)	1	A
Diode Power Dissipation	100	mW
Phototransistor Collector-Emitter Voltage	30	V
Phototransistor Emitter-Collector Voltage	5	V
Operating Temperature Range	-25°C to + 85°C	
Storage Temperature Range	-40°C to + 100°C	
Lead Soldering Temperature [1.6mm(.063") From Case]	260°C for 5 Seconds	

## ELECTRICAL OPTICAL CHARACTERISTICS AT TA=25°C

PARAMETER	SYMBOL	MIN.	TYP.	MAX.	UNIT	TEST CONDITION
<b>INPUT LED</b>						
Forward Voltage	VF		1.2	1.6	V	IF = 20mA
Reverse Current	IR			100	μA	VR=5V
<b>OUTPUT PHOTOTRANSISTOR</b>						
Collector-Emitter Breakdown Voltage	V(BR)CEO	30			V	IC=1mA
Emitter-Collector Breakdown Voltage	V(BR)ECO	5			V	IE=100 μA
Collector-Emitter Dark Current	ICEO			100	nA	VCE=10V
<b>COUPLER</b>						
Collector-Emitter Saturation Voltage	VCE(SAT)			0.4	V	IC=0.25mA IF=20mA
On State Collector Current	Ic(ON)	0.5			mA	VCE=5V IF=20mA
Response Time	Rise Time	tr	3	15	μS	VCE=5V, Ic=2mA RL=100Ω
	Fall Time	tf	4	20		

## TYPICAL ELECTRICAL / OPTICAL CHARACTERISTICS CURVES

(25°C Ambient Temperature Unless Otherwise Noted)

Fig.1 Power Dissipation vs. Ambient Temperature

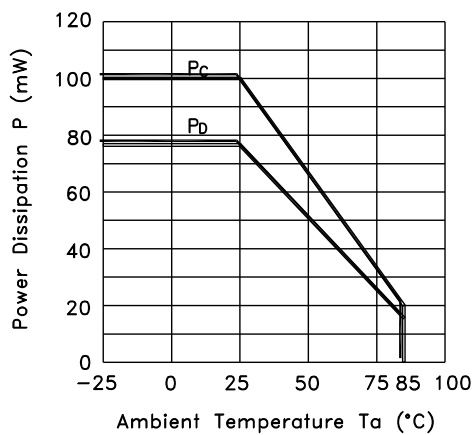

Fig.2 Forward Current vs. Forward Voltage

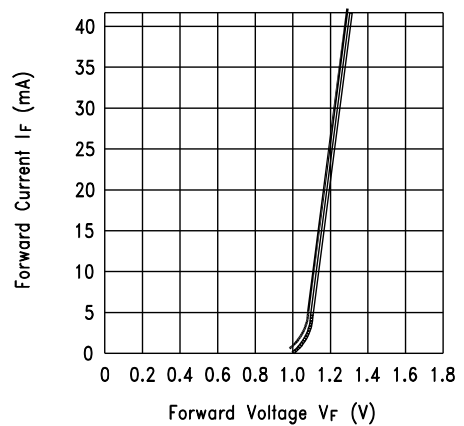

Fig.3 Collector Current vs. Collector-emitter Voltage

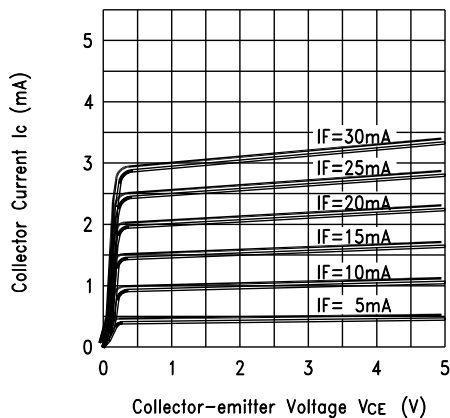
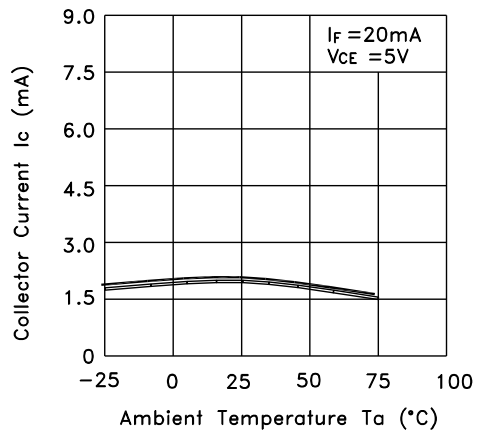

Fig.4 Collector Current vs. Ambient Temperature



## TYPICAL ELECTRICAL / OPTICAL CHARACTERISTICS CURVES

(25°C Ambient Temperature Unless Otherwise Noted)

Fig.5 Collector-emitter Saturation Voltage vs. Ambient Temperature

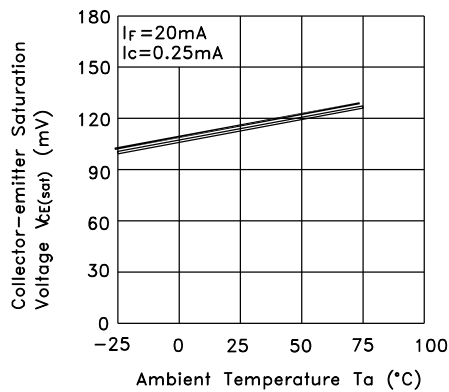
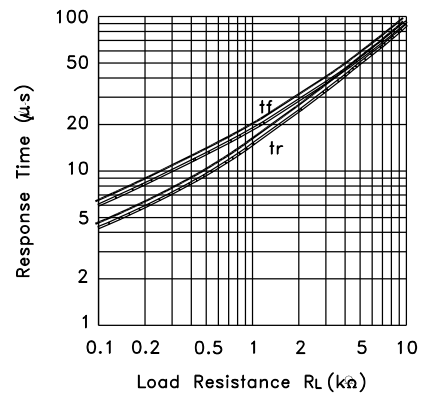
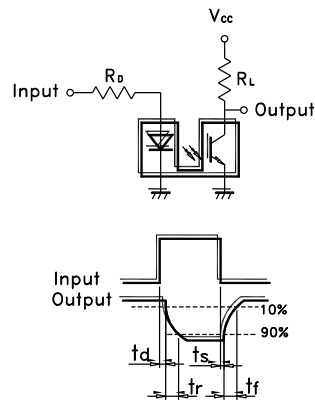

Fig.6 Response Time vs. Load Resistance



Test Circuit for Response Time







## Looking for pricing, stock, or lifecycle information?

Click below to explore more details on WIN SOURCE:

 [View LTH-301-05 on WIN SOURCE](#)

 [Lite-On Inc. Information](#)

## Optimize Your Supply Chain with WIN SOURCE Solutions

-  Global Sourcing Solution
-  Obsolete Management
-  Cost Control Management
-  Shortage Management
-  Alternative Solution
-  Excess Inventory Management