



**THE DATASHEET OF
1SMA22AT3G**



1SMA5.0AT3G Series, SZ1SMA5.0AT3G Series

400 Watt Peak Power Zener Transient Voltage Suppressors

Unidirectional

The SMA series is designed to protect voltage sensitive components from high voltage, high energy transients. They have excellent clamping capability, high surge capability, low zener impedance and fast response time. The SMA series is supplied in ON Semiconductor's exclusive, cost-effective, highly reliable SURMETIC® package and is ideally suited for use in communication systems, automotive, numerical controls, process controls, medical equipment, business machines, power supplies and many other industrial/consumer applications.

Features

- Working Peak Reverse Voltage Range – 5.0 V to 78 V
- Standard Zener Breakdown Voltage Range – 6.7 V to 91.25 V
- Peak Power – 400 W @ 1 ms
- ESD Rating of Class 3 (> 16 kV) per Human Body Model
- Response Time is Typically < 1 ns
- Flat Handling Surface for Accurate Placement
- Package Design for Top Slide or Bottom Circuit Board Mounting
- Low Profile Package
- SZ Prefix for Automotive and Other Applications Requiring Unique Site and Control Change Requirements; AEC-Q101 Qualified and PPAP Capable
- These are Pb-Free Devices*

Mechanical Characteristics:

CASE: Void-free, transfer-molded plastic

FINISH: All external surfaces are corrosion resistant and leads are readily solderable

MAXIMUM CASE TEMPERATURE FOR SOLDERING PURPOSES: 260°C for 10 Seconds

POLARITY: Cathode indicated by molded polarity notch or polarity band

MOUNTING POSITION: Any

*For additional information on our Pb-Free strategy and soldering details, please download the ON Semiconductor Soldering and Mounting Techniques Reference Manual, SOLDERRM/D.



ON Semiconductor®

www.onsemi.com

PLASTIC SURFACE MOUNT ZENER OVERVOLTAGE TRANSIENT SUPPRESSORS 5.0 – 78 V, 400 W PEAK POWER



SMA
CASE 403D
STYLE 1

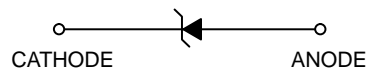

MARKING DIAGRAM



- xx = Device Code (Refer to page 3)
- A = Assembly Location
- Y = Year
- WW = Work Week
- = Pb-Free Package

ORDERING INFORMATION

Device	Package	Shipping†
1SMAxxAT3G	SMA (Pb-Free)	5,000 / Tape & Reel
SZ1SMAxxAT3G	SMA (Pb-Free)	5,000 / Tape & Reel

†For information on tape and reel specifications, including part orientation and tape sizes, please refer to our Tape and Reel Packaging Specifications Brochure, BRD8011/D.

DEVICE MARKING INFORMATION

See specific marking information in the device marking column of the Electrical Characteristics table on page 3 of this data sheet.

1SMA5.0AT3G Series, SZ1SMA5.0AT3G Series

MAXIMUM RATINGS

Rating	Symbol	Value	Unit
Peak Power Dissipation (Note 1) @ $T_L = 25^\circ\text{C}$, Pulse Width = 1 ms	P_{PK}	400	W
DC Power Dissipation @ $T_L = 75^\circ\text{C}$ Measured Zero Lead Length (Note 2) Derate Above 75°C	P_D	1.5	W
Thermal Resistance from Junction to Lead	$R_{\theta JL}$	20	$\text{mW}/^\circ\text{C}$
DC Power Dissipation (Note 3) @ $T_A = 25^\circ\text{C}$ Derate Above 25°C	P_D	0.5	W
Thermal Resistance from Junction to Ambient	$R_{\theta JA}$	4.0	$\text{mW}/^\circ\text{C}$
Forward Surge Current (Note 4) @ $T_A = 25^\circ\text{C}$	I_{FSM}	250	$^\circ\text{C}/\text{W}$
Operating and Storage Temperature Range	T_J, T_{stg}	-65 to +150	$^\circ\text{C}$

Stresses exceeding those listed in the Maximum Ratings table may damage the device. If any of these limits are exceeded, device functionality should not be assumed, damage may occur and reliability may be affected.

- 10 X 1000 μs , non-repetitive.
- 1" square copper pad, FR-4 board.
- FR-4 board, using ON Semiconductor minimum recommended footprint, as shown in 403B case outline dimensions spec.
- 1/2 sine wave (or equivalent square wave), PW = 8.3 ms, duty cycle = 4 pulses per minute maximum.

ELECTRICAL CHARACTERISTICS ($T_A = 25^\circ\text{C}$ unless otherwise noted, $V_F = 3.5\text{ V Max.}$ @ $I_F = 30\text{ A}$ for all types) (Note 5)

Symbol	Parameter
I_{PP}	Maximum Reverse Peak Pulse Current
V_C	Clamping Voltage @ I_{PP}
V_{RWM}	Working Peak Reverse Voltage
I_R	Maximum Reverse Leakage Current @ V_{RWM}
V_{BR}	Breakdown Voltage @ I_T
I_T	Test Current
I_F	Forward Current
V_F	Forward Voltage @ I_F

- 1/2 sine wave or equivalent, PW = 8.3 ms, non-repetitive duty cycle.

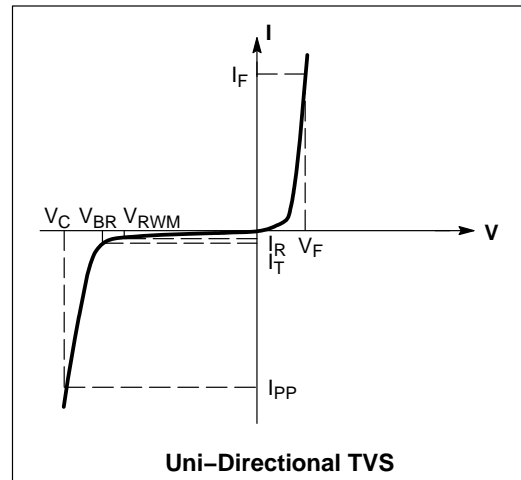

1SMA5.0AT3G Series, SZ1SMA5.0AT3G Series

ELECTRICAL CHARACTERISTICS

Device*	Device Marking	V _{RWM} (Note 6) Volts	I _R @ V _{RWM} μA	Breakdown Voltage			V _C @ I _{PP} (Note 8)		C Typ. (Note 9) pF	
				V _{BR} (Volts) (Note 7)			@ I _T	V _C		I _{PP}
				Min	Nom	Max	mA	Volts		Amps
1SMA5.0AT3G	QE	5.0	400	6.4	6.7	7.0	10	9.2	43.5	2035
1SMA6.0AT3G	QG	6.0	400	6.67	7.02	7.37	10	10.3	38.8	1730
1SMA6.5AT3G	QK	6.5	250	7.22	7.6	7.98	10	11.2	35.7	1605
1SMA8.0AT3G	QR	8.0	25	8.89	9.36	9.83	1	13.6	29.4	1035
1SMA8.5AT3G	QT	8.5	5.0	9.44	9.92	10.4	1	14.4	27.8	1265
1SMA9.0AT3G	QV	9.0	2.5	10	10.55	11.1	1	15.4	26.0	1200
1SMA10AT3G	QX	10	2.5	11.1	11.7	12.3	1	17.0	23.5	1090
1SMA11AT3G	QZ	11	2.5	12.2	12.85	13.5	1	18.2	22.0	1000
1SMA12AT3G	RE	12	2.5	13.3	14.0	14.7	1	19.9	20.1	925
1SMA13AT3G	RG	13	2.5	14.4	15.15	15.9	1	21.5	18.6	860
1SMA14AT3G	RH	14	2.5	15.6	16.4	17.2	1	23.2	17.2	800
1SMA15AT3G	RM	15	2.5	16.7	17.6	18.5	1	24.4	16.4	758
1SMA16AT3G	RP	16	2.5	17.8	18.75	19.7	1	26.0	15.4	715
1SMA17AT3G	RR	17	2.5	18.9	19.9	20.9	1	27.6	14.5	680
1SMA18AT3G	RT	18	2.5	20	21.05	22.1	1	29.2	13.7	645
1SMA20AT3G	RV	20	2.5	22.2	23.35	24.5	1	32.4	12.3	585
1SMA22AT3G	RX	22	2.5	24.4	25.65	26.9	1	35.5	11.3	540
1SMA24AT3G	RZ	24	2.5	26.7	28.1	29.5	1	38.9	10.3	500
1SMA26AT3G	SE	26	2.5	28.9	30.4	31.9	1	42.1	9.5	460
1SMA28AT3G	SG	28	2.5	31.1	32.75	34.4	1	45.4	8.8	430
1SMA30AT3G	SK	30	2.5	33.3	35.05	36.8	1	48.4	8.3	405
1SMA33AT3G	SM	33	2.5	36.7	38.65	40.6	1	53.3	7.5	375
1SMA36AT3G	SP	36	2.5	40	42.1	44.2	1	58.1	6.9	345
1SMA40AT3G	SR	40	2.5	44.4	46.75	49.1	1	64.5	6.2	315
1SMA43AT3G	ST	43	2.5	47.8	50.3	52.8	1	69.4	5.8	295
1SMA45AT3G	SV	45	2.5	50	52.65	55.3	1	72.2	5.5	280
1SMA48AT3G	SX	48	2.5	53.3	56.1	58.9	1	77.4	5.2	265
1SMA54AT3G	TE	54	2.5	60	63.15	66.3	1	87.1	4.6	240
1SMA58AT3G	TG	58	2.5	64.4	67.8	71.5	1	93.6	4.3	225
1SMA70AT3G	TP	70	2.5	77.8	81.9	86.0	1	113	3.5	190

6. A transient suppressor is normally selected according to the working peak reverse voltage (V_{RWM}), which should be equal to or greater than the DC or continuous peak operating voltage level.

7. V_{BR} measured at pulse test current I_T at an ambient temperature of 25°C.

8. Surge current waveform per Figure 2 and derate per Figure 3.

9. Bias voltage = 0 V, F = 1.0 MHz, T_J = 25°C.

†Please see 1SMA10CAT3 to 1SMA75CAT3 for Bidirectional devices.

* Include SZ-prefix devices where applicable.

1SMA5.0AT3G Series, SZ1SMA5.0AT3G Series

RATING AND TYPICAL CHARACTERISTIC CURVES

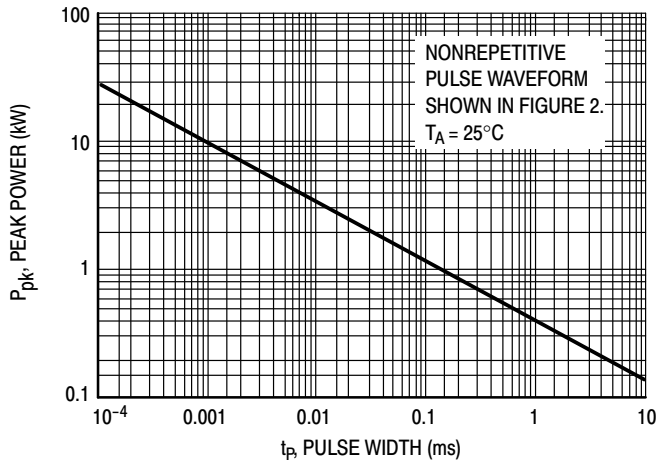

Figure 1. Pulse Rating Curve

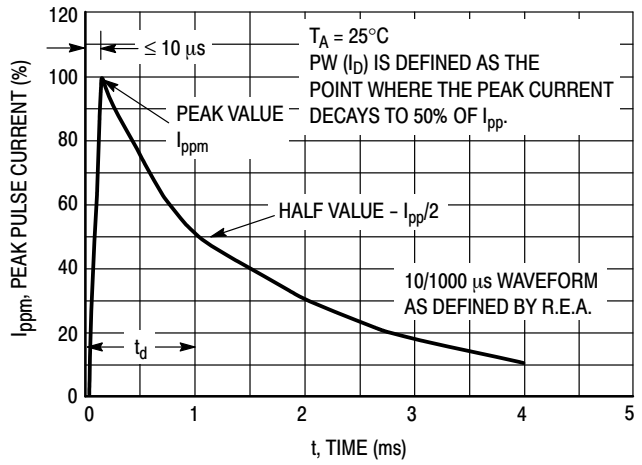

Figure 2. Pulse Waveform

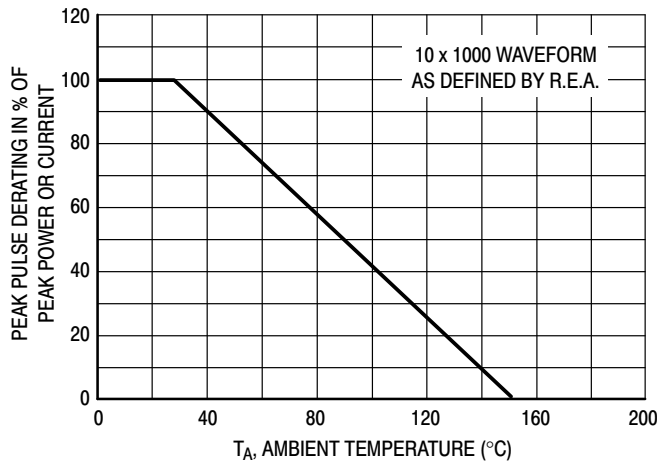

Figure 3. Pulse Derating Curve

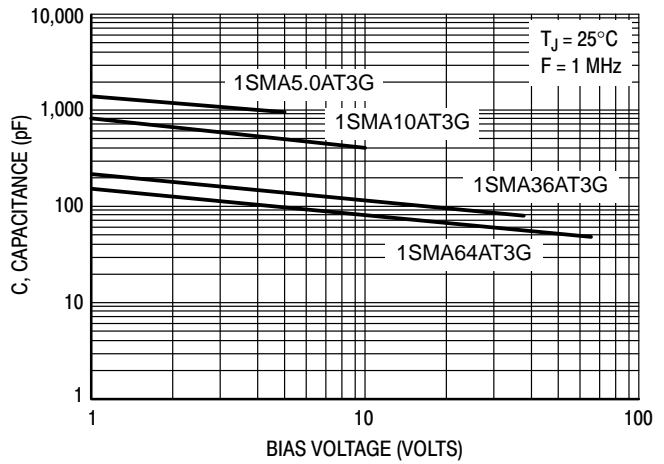

Figure 4. Typical Junction Capacitance vs. Bias Voltage

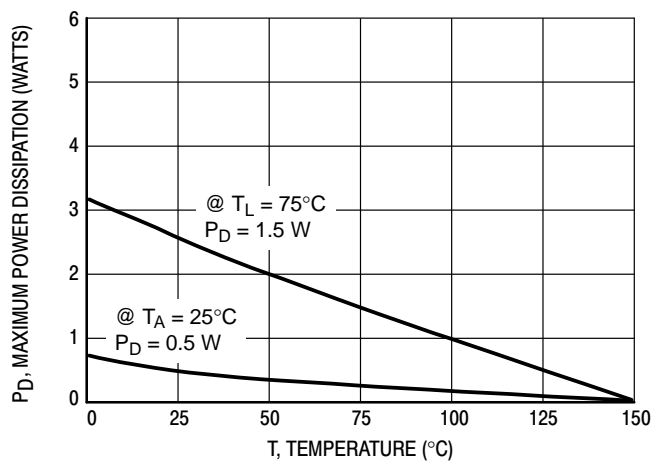
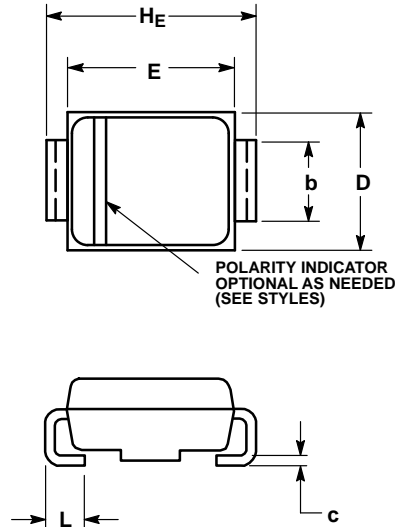

Figure 5. Steady State Power Derating

1SMA5.0AT3G Series, SZ1SMA5.0AT3G Series

PACKAGE DIMENSIONS

SMA CASE 403D ISSUE H



- NOTES:
1. DIMENSIONING AND TOLERANCING PER ANSI Y14.5M, 1982.
 2. CONTROLLING DIMENSION: INCH.
 3. DIMENSION b SHALL BE MEASURED WITHIN DIMENSION L.

DIM	MILLIMETERS			INCHES		
	MIN	NOM	MAX	MIN	NOM	MAX
A	1.97	2.10	2.20	0.078	0.083	0.087
A1	0.05	0.10	0.20	0.002	0.004	0.008
b	1.27	1.45	1.63	0.050	0.057	0.064
c	0.15	0.28	0.41	0.006	0.011	0.016
D	2.29	2.60	2.92	0.090	0.103	0.115
E	4.06	4.32	4.57	0.160	0.170	0.180
HE	4.83	5.21	5.59	0.190	0.205	0.220
L	0.76	1.14	1.52	0.030	0.045	0.060

- STYLE 1:
PIN 1. CATHODE (POLARITY BAND)
2. ANODE

SOLDERING FOOTPRINT*

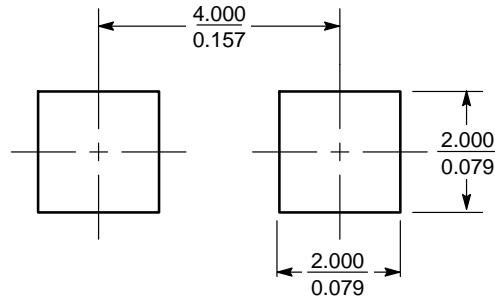

SCALE 8:1 $\left(\frac{\text{mm}}{\text{inches}}\right)$

*For additional information on our Pb-Free strategy and soldering details, please download the ON Semiconductor Soldering and Mounting Techniques Reference Manual, SOLDERM/D.

SURMETIC is a registered trademark of Semiconductor Components Industries, LLC.

ON Semiconductor and are registered trademarks of Semiconductor Components Industries, LLC (SCILLC). SCILLC reserves the right to make changes without further notice to any products herein. SCILLC makes no warranty, representation or guarantee regarding the suitability of its products for any particular purpose, nor does SCILLC assume any liability arising out of the application or use of any product or circuit, and specifically disclaims any and all liability, including without limitation special, consequential or incidental damages. "Typical" parameters which may be provided in SCILLC data sheets and/or specifications can and do vary in different applications and actual performance may vary over time. All operating parameters, including "Typicals" must be validated for each customer application by customer's technical experts. SCILLC does not convey any license under its patent rights nor the rights of others. SCILLC products are not designed, intended, or authorized for use as components in systems intended for surgical implant into the body, or other applications intended to support or sustain life, or for any other application in which the failure of the SCILLC product could create a situation where personal injury or death may occur. Should Buyer purchase or use SCILLC products for any such unintended or unauthorized application, Buyer shall indemnify and hold SCILLC and its officers, employees, subsidiaries, affiliates, and distributors harmless against all claims, costs, damages, and expenses, and reasonable attorney fees arising out of, directly or indirectly, any claim of personal injury or death associated with such unintended or unauthorized use, even if such claim alleges that SCILLC was negligent regarding the design or manufacture of the part. SCILLC is an Equal Opportunity/Affirmative Action Employer. This literature is subject to all applicable copyright laws and is not for resale in any manner.

PUBLICATION ORDERING INFORMATION

LITERATURE FULFILLMENT:
Literature Distribution Center for ON Semiconductor
P.O. Box 5163, Denver, Colorado 80217 USA
Phone: 303-675-2175 or 800-344-3860 Toll Free USA/Canada
Fax: 303-675-2176 or 800-344-3867 Toll Free USA/Canada
Email: orderlit@onsemi.com

N. American Technical Support: 800-282-9855 Toll Free
USA/Canada
Europe, Middle East and Africa Technical Support:
Phone: 421 33 790 2910
Japan Customer Focus Center
Phone: 81-3-5817-1050

ON Semiconductor Website: www.onsemi.com
Order Literature: <http://www.onsemi.com/orderlit>
For additional information, please contact your local
Sales Representative

Looking for pricing, stock, or lifecycle information?

Click below to explore more details on WIN SOURCE:

 [View 1SMA22AT3G on WIN SOURCE](#)

 [Littelfuse Inc. Information](#)

Optimize Your Supply Chain with WIN SOURCE Solutions

-  Global Sourcing Solution
-  Obsolete Management
-  Cost Control Management
-  Shortage Management
-  Alternative Solution
-  Excess Inventory Management