



MIC5330

Dual 300mA μ Cap LDO in 2mm x 2mm MLF[®]

General Description

The MIC5330 is a tiny Dual Ultra Low Dropout (ULDO™) linear regulator ideally suited for portable electronics due to its high power supply ripple rejection (PSRR) and ultra low output noise. The MIC5330 integrates two high performance 300mA ULDOs into a tiny 2mm x 2mm leadless MLF[®] package, which provides exceptional thermal package characteristics.

The MIC5330 is a μ Cap design which enables operation with very small ceramic output capacitors for stability, thereby reducing required board space and component cost. The combination of extremely low drop out voltage, high power supply rejection and exceptional thermal package characteristics makes it ideal for powering RF/noise sensitive circuitry, cellular phone camera modules, imaging sensors for digital still cameras, PDAs, MP3 players and WebCam applications.

The MIC5330 ULDO™ is available in fixed output voltages in the tiny 8-pin 2mm x 2mm leadless MLF[®] package which occupies less than half the board area of a single SOT-6 package. Additional voltage options are available. For more information, contact Micrel marketing department.

Data sheets and support documentation are found on the Micrel web site: www.micrel.com.

Features

- 2.3V to 5.5V input voltage range
- Ultra low dropout voltage ULDO™ 75mV @ 300mA
- High PSRR - >70dB @ 1KHz
- Ultra-low output noise: 30 μ V_{RMS}
- \pm 2% initial output accuracy
- Tiny 8-pin 2mm x 2mm MLF[®] leadless package
- Excellent Load/Line transient response
- Fast start up time: 30 μ s
- 300mA output current per LDO
- Thermal shutdown protection
- Low quiescent current: 75 μ A per output
- Current limit protection

Applications

- Mobile phones
- PDAs
- GPS receivers
- Portable electronics
- Portable media players
- Digital still and video cameras

Typical Application

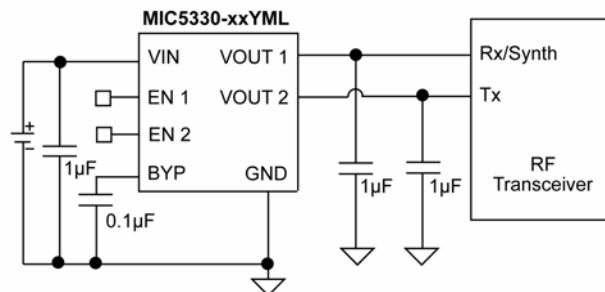

RF Power Supply Circuit

ULDO is a trademark of Micrel, Inc.

MLF and *MicroLeadFrame* are registered trademarks of Amkor Technology, Inc.

Micrel Inc. • 2180 Fortune Drive • San Jose, CA 95131 • USA • tel +1 (408) 944-0800 • fax + 1 (408) 474-1000 • <http://www.micrel.com>

Block Diagram

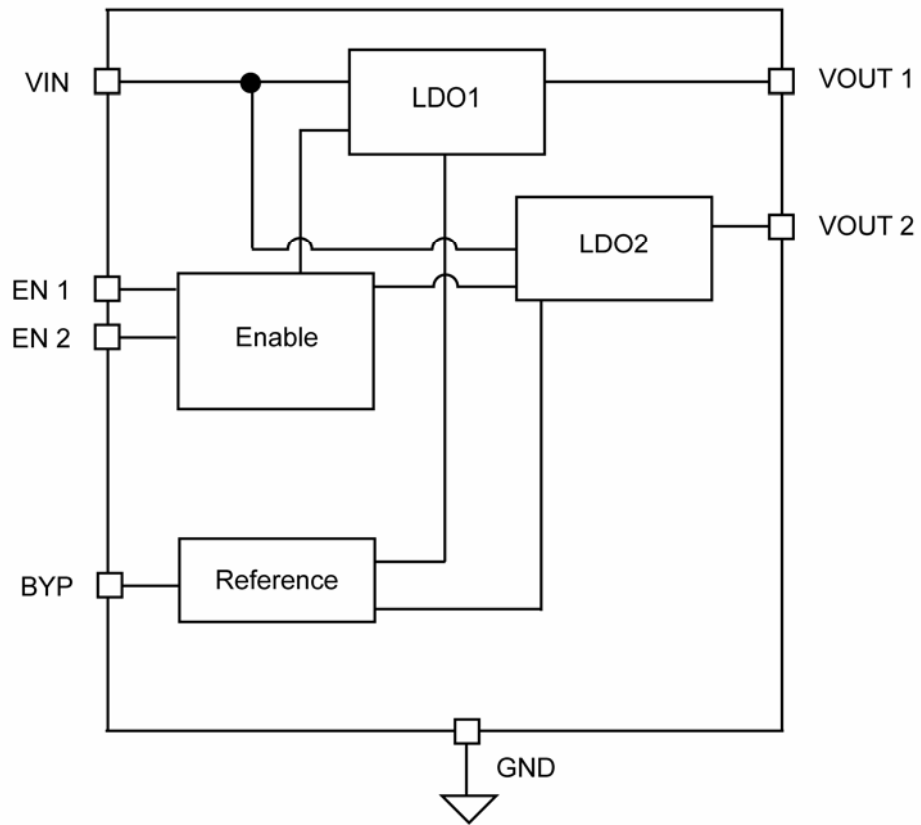

MIC5330 Fixed Block Diagram

Ordering Information

Functional Part number	Ordering Part Number	Marking ¹	V _{OUT1} /V _{OUT2} ²	Junction Temperature Range	Package ³
MIC5330-1.8/1.5YML	MIC5330-GFYML	$\overline{\text{EGF}}$	1.8V/1.5V	-40°C to +125°C	8-Pin 2x2 MLF [®]
MIC5330-1.8/1.8YML	MIC5330-GGYML	$\overline{\text{EGG}}$	1.8V/1.8V	-40°C to +125°C	8-Pin 2x2 MLF [®]
MIC5330-1.8/1.6YML	MIC5330-GWYML	$\overline{\text{EGW}}$	1.8V/1.6V	-40°C to +125°C	8-Pin 2x2 MLF [®]
MIC5330-2.5/1.8YML	MIC5330-JGYML	$\overline{\text{EJG}}$	2.5V/1.8V	-40°C to +125°C	8-Pin 2x2 MLF [®]
MIC5330-2.5/2.5YML	MIC5330-JJYML	$\overline{\text{EJJ}}$	2.5V/2.5V	-40°C to +125°C	8-Pin 2x2 MLF [®]
MIC5330-2.6/1.85YML	MIC5330-KDYML	$\overline{\text{EKD}}$	2.6V/1.85	-40°C to +125°C	8-Pin 2x2 MLF [®]
MIC5330-2.6/1.8YML	MIC5330-KGYML	$\overline{\text{EKG}}$	2.6V/1.8V	-40°C to +125°C	8-Pin 2x2 MLF [®]
MIC5330-2.7/2.7YML	MIC5330-LLYML	$\overline{\text{ELL}}$	2.7V/2.7V	-40°C to +125°C	8-Pin 2x2 MLF [®]
MIC5330-2.8/1.5YML	MIC5330-MFYML	$\overline{\text{EMF}}$	2.8V/1.5V	-40°C to +125°C	8-Pin 2x2 MLF [®]
MIC5330-2.8/1.8YML	MIC5330-MGYML	$\overline{\text{EMG}}$	2.8V/1.8V	-40°C to +125°C	8-Pin 2x2 MLF [®]
MIC5330-2.8/2.6YML	MIC5330-MKYML	$\overline{\text{EMK}}$	2.8V/2.6V	-40°C to +125°C	8-Pin 2x2 MLF [®]
MIC5330-2.8/2.8YML	MIC5330-MMYML	$\overline{\text{EMM}}$	2.8V/2.8V	-40°C to +125°C	8-Pin 2x2 MLF [®]
MIC5330-2.85/1.85YML	MIC5330-NDYML	$\overline{\text{END}}$	2.85V/1.85V	-40°C to +125°C	8-Pin 2x2 MLF [®]
MIC5330-2.85/2.6YML	MIC5330-NKYML	$\overline{\text{ENK}}$	2.85V/2.6V	-40°C to +125°C	8-Pin 2x2 MLF [®]
MIC5330-2.85/2.85YML	MIC5330-NNYML	$\overline{\text{ENN}}$	2.85V/2.85V	-40°C to +125°C	8-Pin 2x2 MLF [®]
MIC5330-2.9/1.5YML	MIC5330-OFYML	$\overline{\text{EOF}}$	2.9V/1.5V	-40°C to +125°C	8-Pin 2x2 MLF [®]
MIC5330-2.9/1.8YML	MIC5330-OGYML	$\overline{\text{EOG}}$	2.9V/1.8V	-40°C to +125°C	8-Pin 2x2 MLF [®]
MIC5330-2.9/2.9YML	MIC5330-OOYML	$\overline{\text{EOO}}$	2.9V/2.9V	-40°C to +125°C	8-Pin 2x2 MLF [®]
MIC5330-3.0/1.8YML	MIC5330-PGYML	$\overline{\text{EPG}}$	3.0V/1.8V	-40°C to +125°C	8-Pin 2x2 MLF [®]
MIC5330-3.0/2.5YML	MIC5330-PJYML	$\overline{\text{EPJ}}$	3.0V/2.5V	-40°C to +125°C	8-Pin 2x2 MLF [®]
MIC5330-3.0/2.6YML	MIC5330-PKYML	$\overline{\text{EPK}}$	3.0V/2.6V	-40°C to +125°C	8-Pin 2x2 MLF [®]
MIC5330-3.0/2.8YML	MIC5330-PMYML	$\overline{\text{EPM}}$	3.0V/2.8V	-40°C to +125°C	8-Pin 2x2 MLF [®]
MIC5330-3.0/2.85YML	MIC5330-PNYML	$\overline{\text{EPN}}$	3.0V/2.85V	-40°C to +125°C	8-Pin 2x2 MLF [®]
MIC5330-3.0/3.0YML	MIC5330-PPYML	$\overline{\text{EPP}}$	3.0V/3.0V	-40°C to +125°C	8-Pin 2x2 MLF [®]
MIC5330-3.3/1.5YML	MIC5330-SFYML	$\overline{\text{ESF}}$	3.3V/1.5V	-40°C to +125°C	8-Pin 2x2 MLF [®]
MIC5330-3.3/1.8YML	MIC5330-SGYML	$\overline{\text{ESG}}$	3.3V/1.8V	-40°C to +125°C	8-Pin 2x2 MLF [®]
MIC5330-3.3/2.5YML	MIC5330-SJYML	$\overline{\text{ESJ}}$	3.3V/2.5V	-40°C to +125°C	8-Pin 2x2 MLF [®]
MIC5330-3.3/2.6YML	MIC5330-SKYML	$\overline{\text{ESK}}$	3.3V/2.6V	-40°C to +125°C	8-Pin 2x2 MLF [®]
MIC5330-3.3/2.8YML	MIC5330-SMYML	$\overline{\text{ESM}}$	3.3V/2.8V	-40°C to +125°C	8-Pin 2x2 MLF [®]
MIC5330-3.3/2.85YML	MIC5330-SNYML	$\overline{\text{ESN}}$	3.3V/2.85V	-40°C to +125°C	8-Pin 2x2 MLF [®]
MIC5330-3.3/2.9YML	MIC5330-SOYML	$\overline{\text{ESO}}$	3.3V/2.9V	-40°C to +125°C	8-Pin 2x2 MLF [®]
MIC5330-3.3/3.0YML	MIC5330-SPYML	$\overline{\text{ESP}}$	3.3V/3.0V	-40°C to +125°C	8-Pin 2x2 MLF [®]
MIC5330-3.3/3.2YML	MIC5330-SRYML	$\overline{\text{ESR}}$	3.3V/3.2V	-40°C to +125°C	8-Pin 2x2 MLF [®]
MIC5330-3.3/3.3YML	MIC5330-SSYML	$\overline{\text{ESS}}$	3.3V/3.3V	-40°C to +125°C	8-Pin 2x2 MLF [®]

Notes:

1. Over bar ($\overline{\quad}$) symbol may not be to scale.
2. Other voltage options available. Contact Micrel for more details.
3. MLF[®] is a GREEN RoHS compliant package. Lead finish is NiPdAu. Mold compound is Halogen Free.

Pin Configuration

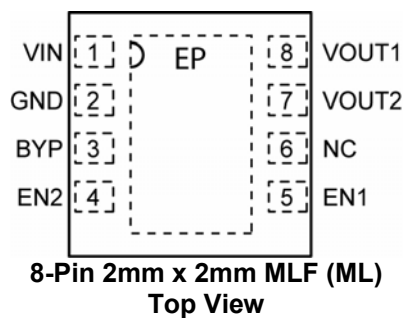

Pin Description

Pin Number MLF-8	Pin Name	Pin Function
1	VIN	Supply Input.
2	GND	Ground
3	BYP	Reference Bypass: Connect external 0.1 μ F to GND to reduce output noise. May be left open when bypass capacitor is not required.
4	EN2	Enable Input (regulator 2). Active High Input. Logic High = On; Logic Low = Off; Do not leave floating.
5	EN1	Enable Input (regulator 1). Active High Input. Logic High = On; Logic Low = Off; Do not leave floating.
6	NC	Not internally connected
7	VOUT2	Regulator Output – LDO2
8	VOUT1	Regulator Output – LDO1
–	EP	Exposed Pad. Connect EP to GND.

Absolute Maximum Ratings⁽¹⁾

Supply Voltage (V_{IN})	0V to +6V
Enable Input Voltage (V_{EN})	0V to +6V
Power Dissipation	Internally Limited ⁽³⁾
Lead Temperature (soldering, 3sec)	260°C
Storage Temperature (T_S)	-65°C to +150°C
ESD Rating ⁽⁴⁾	2kV

Operating Ratings⁽²⁾

Supply voltage (V_{IN})	+2.3V to +5.5V
Enable Input Voltage (V_{EN})	0V to V_{IN}
Junction Temperature	-40°C to +125°C
Junction Thermal Resistance	
MLF-8 (θ_{JA})	90°C/W

Electrical Characteristics⁽⁵⁾

$V_{IN} = EN1 = EN2 = V_{OUT} + 1.0V$; higher of the two regulator outputs, $I_{OUTLDO1} = I_{OUTLDO2} = 100\mu A$; $C_{OUT1} = C_{OUT2} = 1\mu F$; $C_{BYP} = 0.1\mu F$; $T_J = 25^\circ C$, **bold** values indicate $-40^\circ C \leq T_J \leq +125^\circ C$, unless noted.

Parameter	Conditions	Min	Typ	Max	Units
Output Voltage Accuracy	Variation from nominal V_{OUT}	-2.0		+2.0	%
	Variation from nominal V_{OUT} ; $-40^\circ C$ to $+125^\circ C$	-3.0		+3.0	%
Line Regulation	$V_{IN} = V_{OUT} + 1V$ to 5.5V; $I_{OUT} = 100\mu A$		0.02	0.3 0.6	%/V %/V
Load Regulation	$I_{OUT} = 100\mu A$ to 300mA		0.5		%
Dropout Voltage (Note 6)	$I_{OUT} = 100\mu A$		0.1		mV
	$I_{OUT} = 100mA$		25	75	mV
	$I_{OUT} = 150mA$		35	100	mV
	$I_{OUT} = 300mA$		75	200	mV
Ground Current	EN1 = High; EN2 = Low; $I_{OUT} = 100\mu A$ to 300mA		85	120	μA
	EN1 = Low; EN2 = High; $I_{OUT} = 100\mu A$ to 300mA		85	120	μA
	EN1 = EN2 = High; $I_{OUT1} = 300mA$, $I_{OUT2} = 300mA$		150	200	μA
Ground Current in Shutdown	EN1 = EN2 = 0V		0.01	2	μA
Ripple Rejection	$f = 1kHz$; $C_{OUT} = 1.0\mu F$; $C_{BYP} = 0.1\mu F$		70		dB
	$f = 20kHz$; $C_{OUT} = 1.0\mu F$; $C_{BYP} = 0.1\mu F$		65		dB
Current Limit	$V_{OUT} = 0V$	350	550	950	mA
Output Voltage Noise	$C_{OUT} = 1.0\mu F$; $C_{BYP} = 0.1\mu F$; 10Hz to 100kHz		30		μV_{RMS}
Enable Inputs (EN1 / EN2)					
Enable Input Voltage	Logic Low			0.2	V
	Logic High	1.1			V
Enable Input Current	$V_{IL} \leq 0.2V$		0.01		μA
	$V_{IH} \geq 1.0V$		0.01		μA
Turn on Time (See Timing Diagram)					
Turn on Time (LDO1 and 2)	$C_{OUT} = 1.0\mu F$; $C_{BYP} = 0.01\mu F$		30	100	μs

Notes:

- Exceeding the absolute maximum rating may damage the device.
- The device is not guaranteed to function outside its operating rating.
- The maximum allowable power dissipation of any T_A (ambient temperature) is $P_{D(max)} = (T_{J(max)} - T_A) / \theta_{JA}$. Exceeding the maximum allowable power dissipation will result in excessive die temperature, and the regulator will go into thermal shutdown.
- Devices are ESD sensitive. Handling precautions recommended. Human body model, 1.5k in series with 100pF.
- Specification for packaged product only.
- Dropout voltage is defined as the input to output differential at which the output voltage drops 2% below its nominal V_{OUT} . For outputs below 2.3V, the dropout voltage is the input to output differential with the minimum input voltage 2.3V.

Typical Characteristics

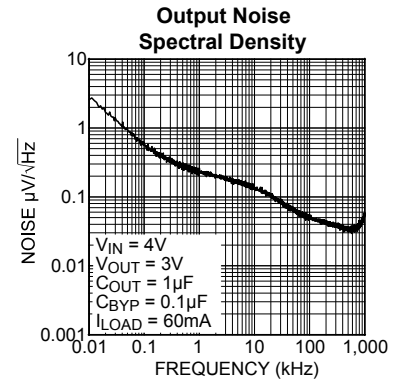
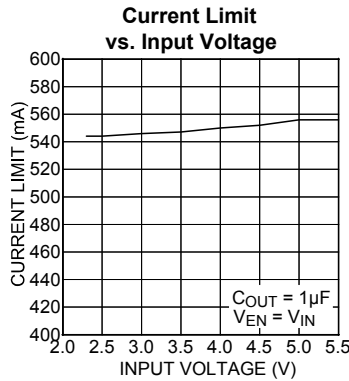
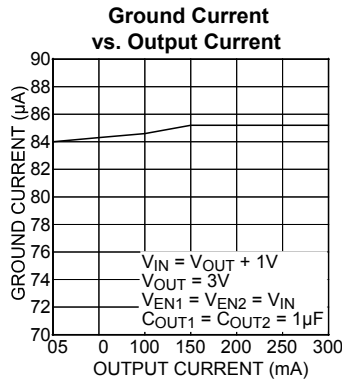
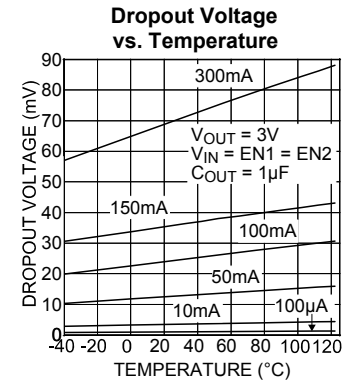
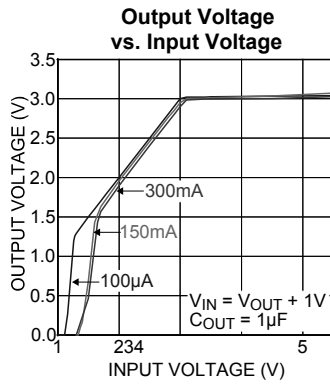
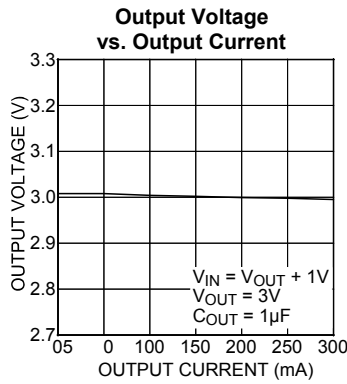
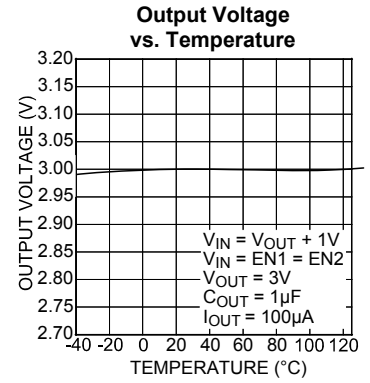
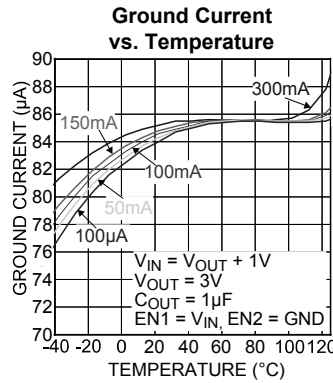
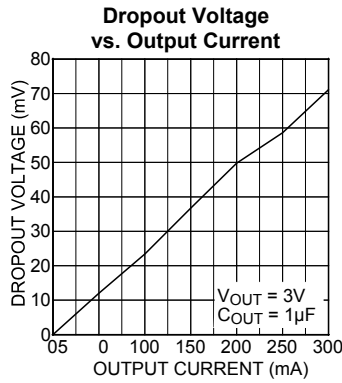
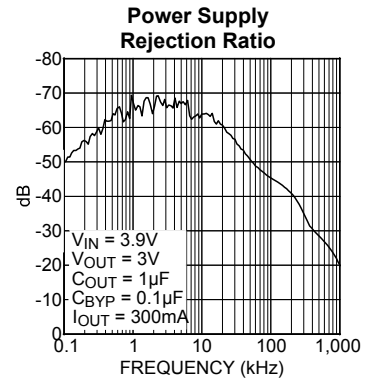
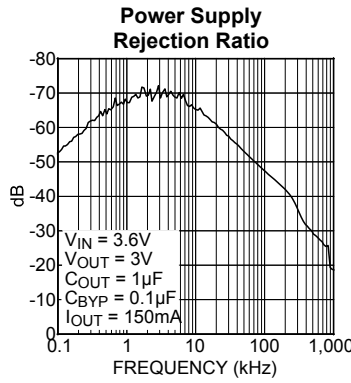
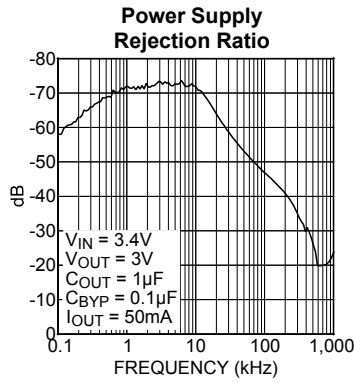

Functional Characteristics

Line Transient

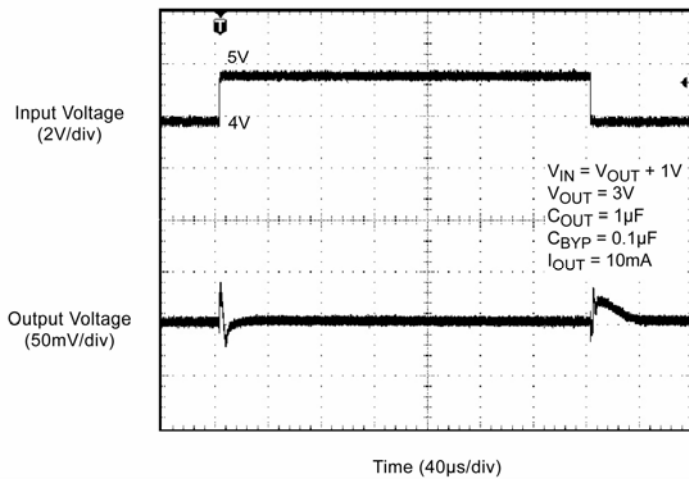

Load Transient

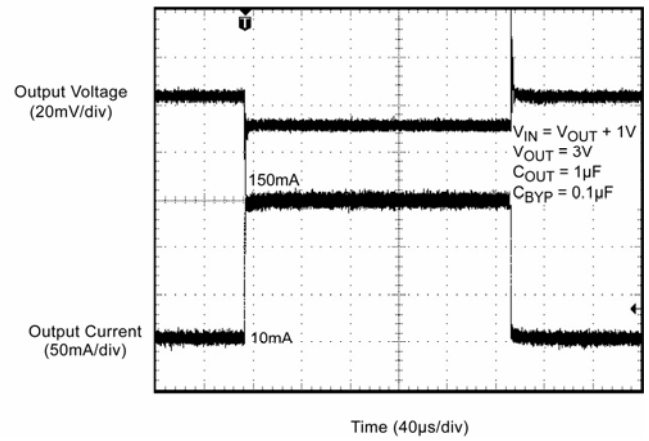

Enable Turn On

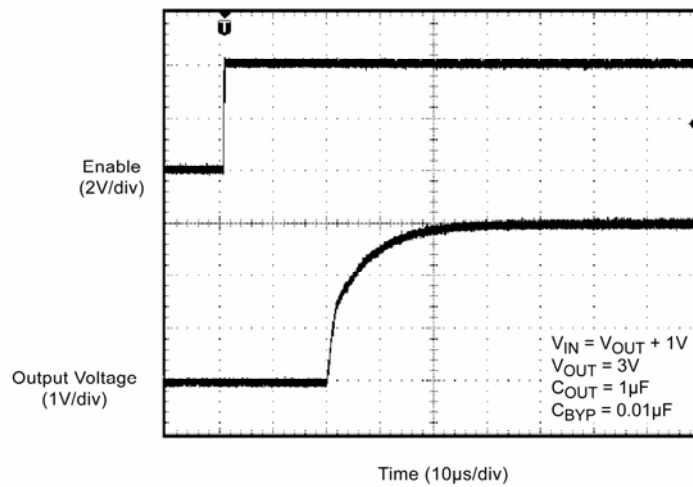

Applications Information

Enable/Shutdown

The MIC5330 comes with dual active high enable pins that allow each regulator to be enabled independently. Forcing the enable pin low disables the regulator and sends it into a “zero” off mode current state. In this state, current consumed by the regulator goes nearly to zero. Forcing the enable pin high enables the output voltage. The active high enable pin uses CMOS technology and the enable pin cannot be left floating; a floating enable pin may cause an indeterminate state on the output.

Input Capacitor

The MIC5330 is a high performance, high bandwidth device. Therefore, it requires a well bypassed input supply for optimal performance. A 1 μ F capacitor is required from the input to ground to provide stability. Low ESR ceramic capacitors provide optimal performance at a minimum of space. Additional high frequency capacitors, such as small valued NPO dielectric type capacitors, help filter out high frequency noise and are good practice in any RF based circuit.

Output Capacitor

The MIC5330 requires an output capacitor of 1 μ F or greater to maintain stability. The design is optimized for use with low ESR ceramic chip capacitors. High ESR capacitors may cause high frequency oscillation. The output capacitor can be increased, but performance has been optimized for a 1 μ F ceramic output capacitor and does not improve significantly with larger capacitance.

X7R/X5R dielectric type ceramic capacitors are recommended because of their temperature performance. X7R type capacitors change capacitance by 15% over their operating temperature range and are the most stable type of ceramic capacitors. Z5U and Y5V dielectric capacitors change value by as much as 50% and 60%, respectively, over their operating temperature ranges. To use a ceramic chip capacitor with Y5V dielectric, the value must be much higher than an X7R ceramic capacitor to ensure the same minimum capacitance over the equivalent operating temperature range.

Bypass Capacitor

A capacitor can be placed from the noise bypass pin to ground to reduce output voltage noise. The capacitor bypasses the internal reference. A 0.1 μ F capacitor is recommended for applications that require low noise outputs. The bypass capacitor can be increased, further reducing noise and improving PSRR. Turn on time increases slightly with respect to

bypass capacitance. A unique, quick start circuit allows the MIC5330 to drive a large capacitor on the bypass pin without significantly slowing turn on time.

No-Load Stability

Unlike many other voltage regulators, the MIC5330 will remain stable and in regulation with no load. This is especially important in CMOS RAM keep alive applications.

Thermal Considerations

The MIC5330 is designed to provide 300mA of continuous current for both outputs in a very small package. Maximum ambient operating temperature can be calculated based on the output current and the voltage drop across the part. Given that the input voltage is 3.3V, the output voltage is 2.8V for V_{OUT1} , 2.5V for V_{OUT2} and the output current = 300mA. The actual power dissipation of the regulator circuit can be determined using the equation:

$$P_D = (V_{IN} - V_{OUT1}) I_{OUT1} + (V_{IN} - V_{OUT2}) I_{OUT2} + V_{IN} I_{GND}$$

Because this device is CMOS and the ground current is typically <100 μ A over the load range, the power dissipation contributed by the ground current is < 1% and can be ignored for this calculation.

$$P_D = (3.3V - 2.8V) \times 300mA + (3.3V - 1.5) \times 300mA$$

$$P_D = 0.69W$$

To determine the maximum ambient operating temperature of the package, use the junction-to-ambient thermal resistance of the device and the following basic equation:

$$P_{D(MAX)} = \left(\frac{T_{J(MAX)} - T_A}{\theta_{JA}} \right)$$

$T_{J(max)} = 125^\circ\text{C}$, the maximum junction temperature of the die θ_{JA} thermal resistance = 90°C/W .

The table below shows junction-to-ambient thermal resistance for the MIC5330 in the MLF package.

Package	θ_{JA} Recommended Minimum Footprint
8-Pin 2x2 MLF [®]	90°C/W

Thermal Resistance

Substituting P_D for $P_{D(max)}$ and solving for the ambient operating temperature will give the maximum operating conditions for the regulator circuit. The junction-to-ambient thermal resistance for the minimum footprint is $90^\circ\text{C}/\text{W}$.

The maximum power dissipation must not be exceeded for proper operation.

For example, when operating the MIC5330-MFYML at an input voltage of 3.3V and 300mA loads at each output with a minimum footprint layout, the maximum ambient operating temperature T_A can be determined as follows:

$$0.99\text{W} = (125^\circ\text{C} - T_A)/(90^\circ\text{C}/\text{W})$$

$$T_A = 62.9^\circ\text{C}$$

Therefore, a 2.8V/1.5V application with 300mA at each output current can accept an ambient operating temperature of 62.9°C in a 2mm x 2mm MLF[®] package. For a full discussion of heat sinking and thermal effects on voltage regulators, refer to the "Regulator Thermals" section of *Micrel's Designing with Low-Dropout Voltage Regulators* handbook. This information can be found on Micrel's website at:

http://www.micrel.com/PDF/other/LDOBk_ds.pdf

Package Information

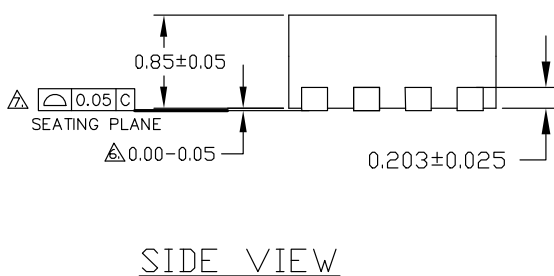
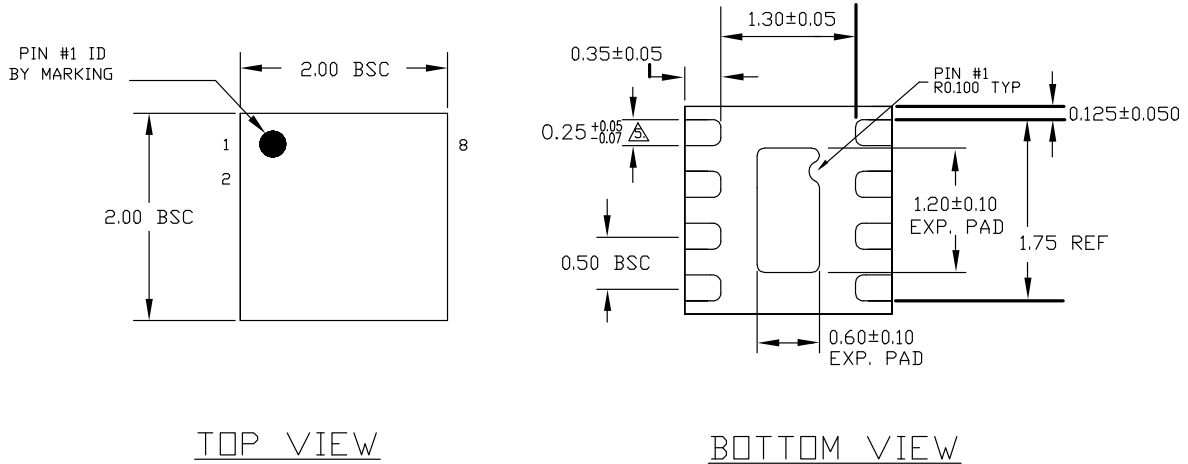

- NOTE:
1. ALL DIMENSIONS ARE IN MILLIMETERS.
 2. MAX. PACKAGE WARPAGE IS 0.05 mm.
 3. MAXIMUM ALLOWABLE BURRS IS 0.076 mm IN ALL DIRECTIONS.
 4. PIN #1 ID ON TOP WILL BE LASER/INK MARKED.
- ⚠ DIMENSION APPLIES TO METALIZED TERMINAL AND IS MEASURED BETWEEN 0.20 AND 0.25 mm FROM TERMINAL TIP.
- ⚠ APPLIED ONLY FOR TERMINALS.
- ⚠ APPLIED FOR EXPOSED PAD AND TERMINALS.

8-Pin 2mm x 2mm MLF (ML)

MICREL, INC. 2180 FORTUNE DRIVE SAN JOSE, CA 95131 USA
 TEL +1 (408) 944-0800 FAX +1 (408) 474-1000 WEB <http://www.micrel.com>

Micrel makes no representations or warranties with respect to the accuracy or completeness of the information furnished in this data sheet. This information is not intended as a warranty and Micrel does not assume responsibility for its use. Micrel reserves the right to change circuitry, specifications and descriptions at any time without notice. No license, whether express, implied, arising by estoppel or otherwise, to any intellectual property rights is granted by this document. Except as provided in Micrel's terms and conditions of sale for such products, Micrel assumes no liability whatsoever, and Micrel disclaims any express or implied warranty relating to the sale and/or use of Micrel products including liability or warranties relating to fitness for a particular purpose, merchantability, or infringement of any patent, copyright or other intellectual property right.

Micrel Products are not designed or authorized for use as components in life support appliances, devices or systems where malfunction of a product can reasonably be expected to result in personal injury. Life support devices or systems are devices or systems that (a) are intended for surgical implant into the body or (b) support or sustain life, and whose failure to perform can be reasonably expected to result in a significant injury to the user. A Purchaser's use or sale of Micrel Products for use in life support appliances, devices or systems is a Purchaser's own risk and Purchaser agrees to fully indemnify Micrel for any damages resulting from such use or sale.

© 2006 Micrel, Incorporated.

Looking for pricing, stock, or lifecycle information?

Click below to explore more details on WIN SOURCE:

- ⊖ [View MIC5330-PKYML-TR on WIN SOURCE](#)
- ⊖ [Microchip Technology](#) Information

Optimize Your Supply Chain with WIN SOURCE Solutions

- ✓ Global Sourcing Solution
- ✓ Obsolete Management
- ✓ Cost Control Management
- ✓ Shortage Management
- ✓ Alternative Solution
- ✓ Excess Inventory Management