



**THE DATASHEET OF
BFN19H6327XTSA1**



PNP Silicon High-Voltage Transistors

- Suitable for video output stages in TV sets and switching power supplies
- High breakdown voltage
- Low collector-emitter saturation voltage
- Complementary types: BFN18 (NPN)
- Pb-free (RoHS compliant) package
- Qualified according AEC Q101

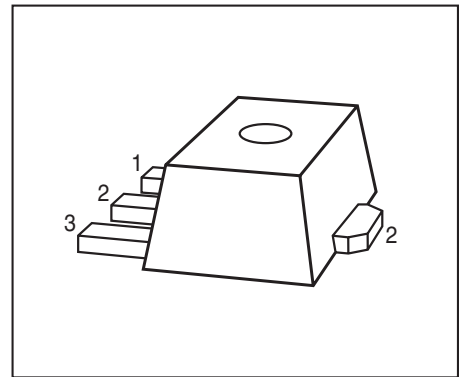

Type	Marking	Pin Configuration			Package
BFN19	DH	1=B	2=C	3=E	SOT89

Maximum Ratings

Parameter	Symbol	Value	Unit
Collector-emitter voltage	V_{CEO}	300	V
Collector-base voltage	V_{CBO}	300	
Emitter-base voltage	V_{EBO}	5	
Collector current	I_C	200	mA
Peak collector current, $t_p \leq 10$ ms	I_{CM}	500	
Base current	I_B	100	
Peak base current	I_{BM}	200	
Total power dissipation- $T_S \leq 130$ °C	P_{tot}	1	W
Junction temperature	T_j	150	°C
Storage temperature	T_{stg}	-65 ... 150	

Thermal Resistance

Parameter	Symbol	Value	Unit
Junction - soldering point ¹⁾	R_{thJS}	≤ 20	K/W

¹⁾For calculation of R_{thJA} please refer to Application Note AN077 (Thermal Resistance Calculation)

Electrical Characteristics at $T_A = 25^\circ\text{C}$, unless otherwise specified

Parameter	Symbol	Values			Unit
		min.	typ.	max.	
DC Characteristics					
Collector-emitter breakdown voltage $I_C = 1\text{ mA}, I_B = 0$	$V_{(BR)CEO}$	300	-	-	V
Collector-base breakdown voltage $I_C = 100\text{ }\mu\text{A}, I_E = 0$	$V_{(BR)CBO}$	300	-	-	
Emitter-base breakdown voltage $I_E = 100\text{ }\mu\text{A}, I_C = 0$	$V_{(BR)EBO}$	5	-	-	
Collector-base cutoff current $V_{CB} = 250\text{ V}, I_E = 0$ $V_{CB} = 250\text{ V}, I_E = 0, T_A = 150\text{ }^\circ\text{C}$	I_{CBO}	-	-	0.1 20	μA
Emitter-base cutoff current $V_{EB} = 5\text{ V}, I_C = 0$	I_{EBO}	-	-	100	nA
DC current gain ¹⁾ $I_C = 1\text{ mA}, V_{CE} = 10\text{ V}$ $I_C = 10\text{ mA}, V_{CE} = 10\text{ V}$ $I_C = 30\text{ mA}, V_{CE} = 10\text{ V}$	h_{FE}	25 40 30	- - -	- - -	-
Collector-emitter saturation voltage ¹⁾ $I_C = 20\text{ mA}, I_B = 2\text{ mA}$	V_{CEsat}	-	-	0.5	V
Base emitter saturation voltage ¹⁾ $I_C = 20\text{ mA}, I_B = 2\text{ mA}$	V_{BEsat}	-	-	0.9	
AC Characteristics					
Transition frequency $I_C = 20\text{ MHz}, V_{CE} = 10\text{ V}, f = 20\text{ MHz}$	f_T	-	100	-	MHz
Collector-base capacitance $V_{CB} = 30\text{ V}, f = 1\text{ MHz}$	C_{cb}	-	2.5	-	pF

¹⁾Pulse test: $t < 300\mu\text{s}$; $D < 2\%$

DC current gain $h_{FE} = f(I_C)$

$V_{CE} = 10\text{ V}$

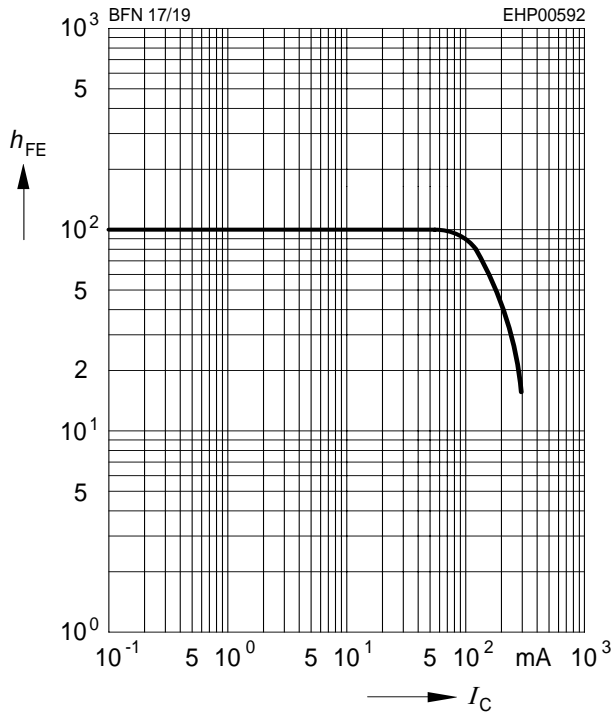

Operating range $I_C = f(V_{CE0})$

$T_A = 25^\circ\text{C}, D = 0$

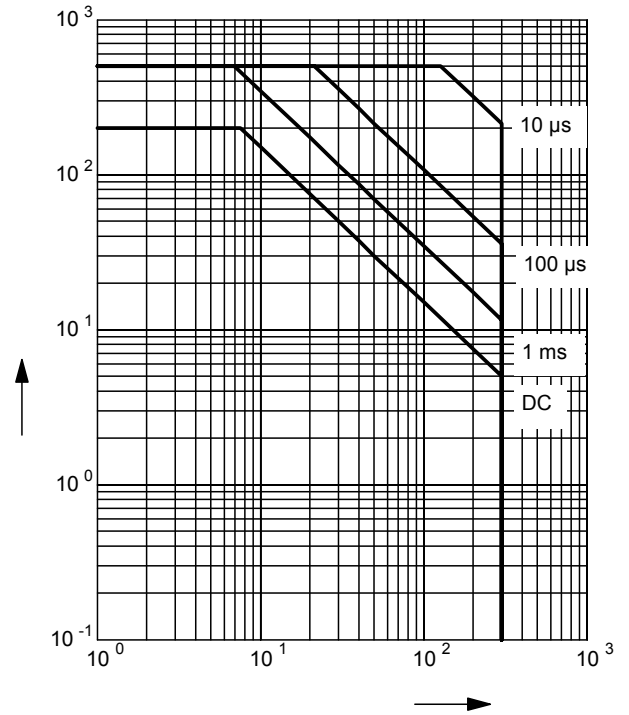

Collector current $I_C = f(V_{BE})$

$V_{CE} = 10\text{ V}$

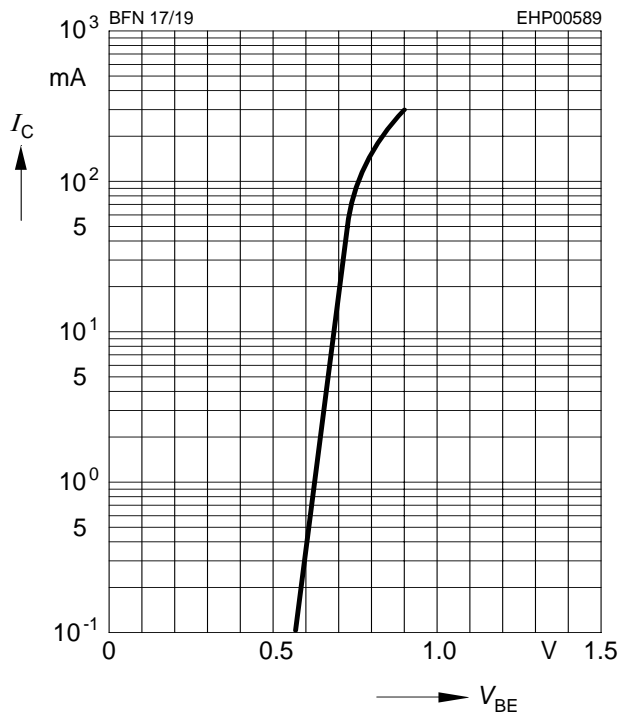

Collector cutoff current $I_{CBO} = f(T_A)$

$V_{CBO} = 200\text{ V}$

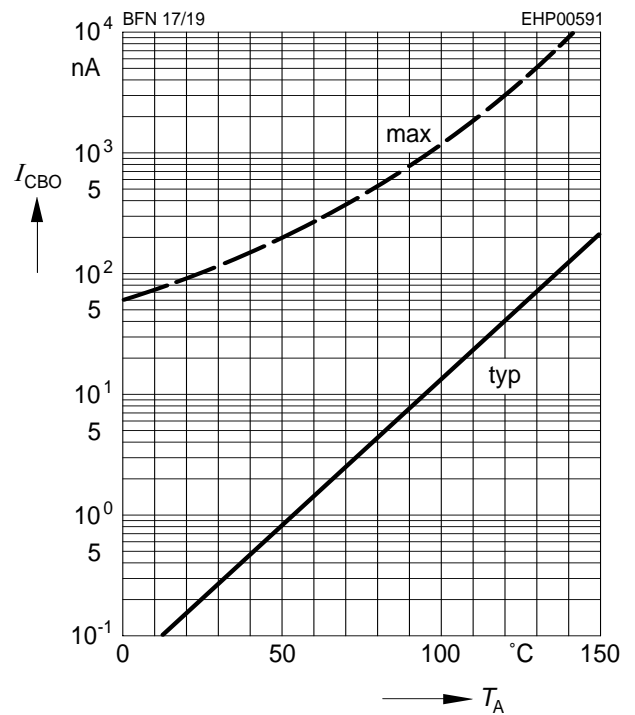

Transition frequency $f_T = f(I_C)$

$V_{CE} = 10\text{ V}$

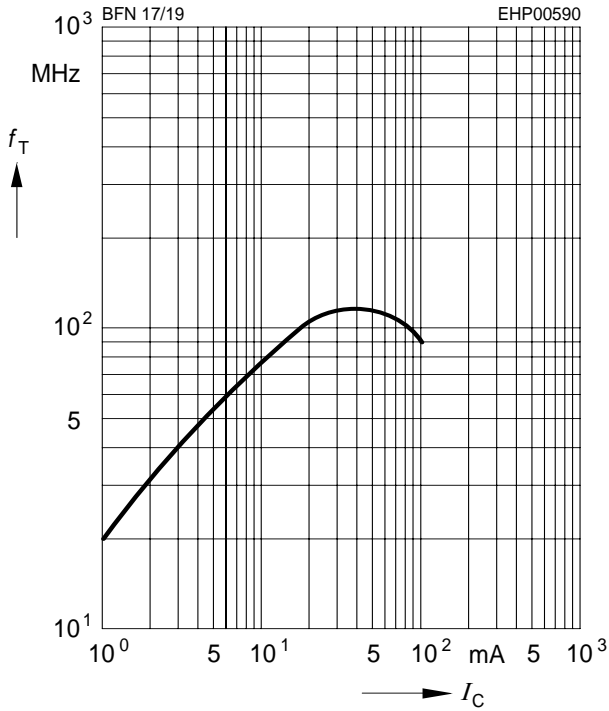

Collector-base capacitance $C_{cb} = f(V_{CB})$

Emitter-base capacitance $C_{eb} = f(V_{EB})$

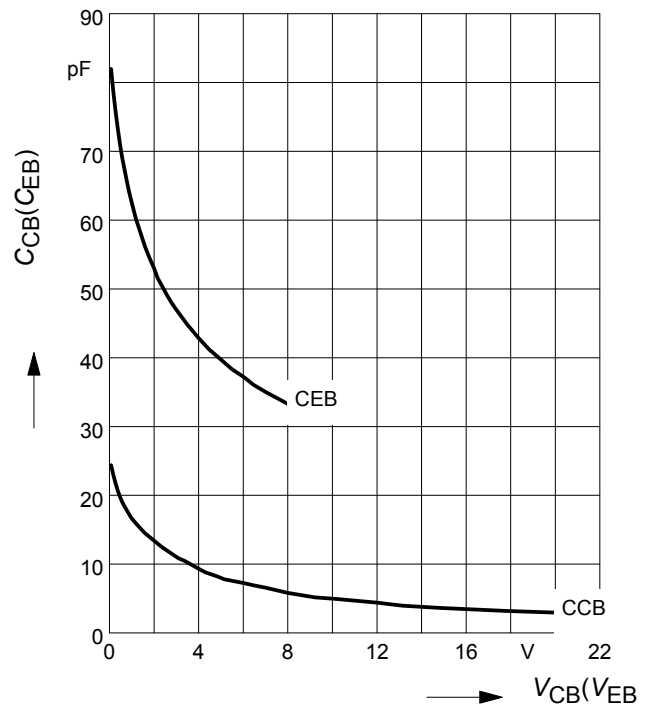

Total power dissipation $P_{tot} = f(T_S)$

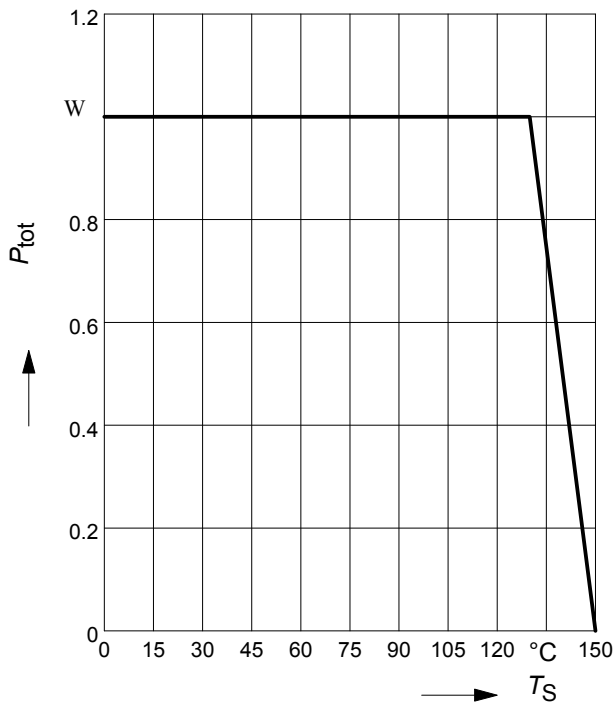

Permissible Pulse Load

$P_{totmax}/P_{totDC} = f(t_p)$

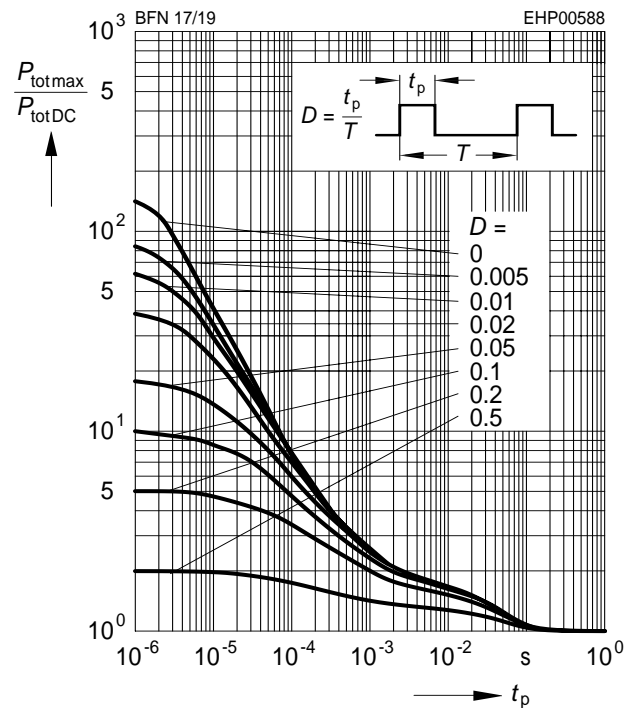

Package Outline

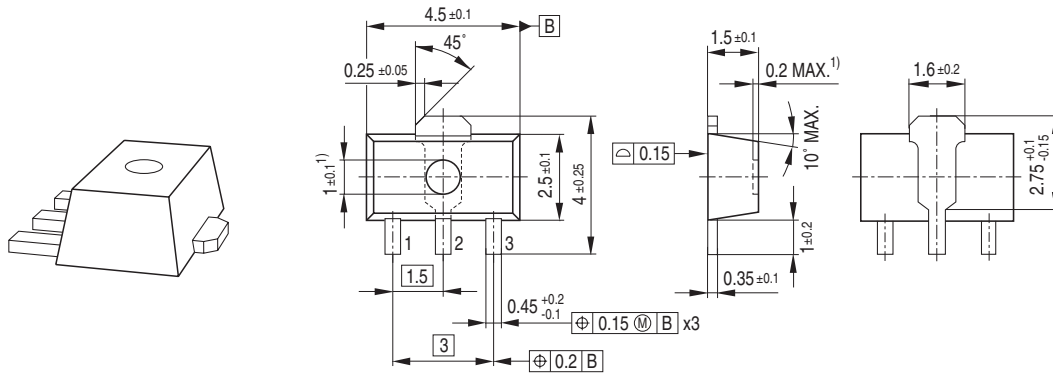

1) Ejector pin markings possible

Foot Print

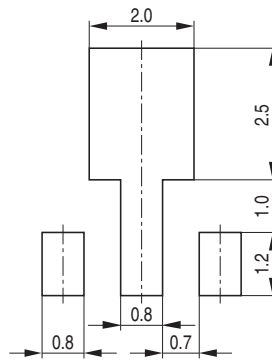

Marking Layout (Example)

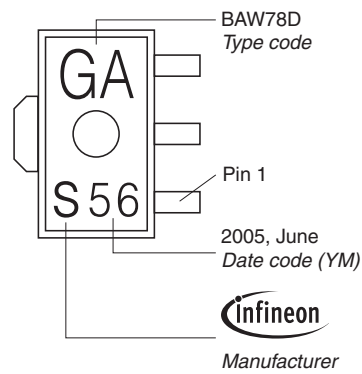

Standard Packing

Reel $\varnothing 180$ mm = 1.000 Pieces/Reel
 Reel $\varnothing 330$ mm = 4.000 Pieces/Reel

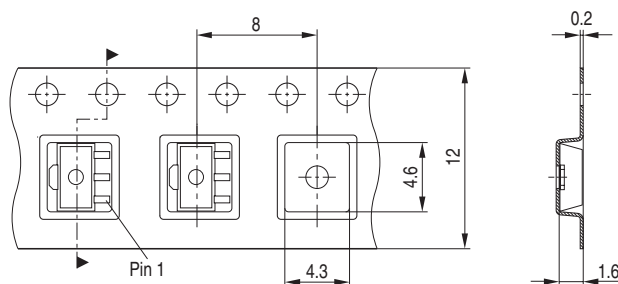

Edition 2009-11-16

**Published by
Infineon Technologies AG
81726 Munich, Germany**

**© 2009 Infineon Technologies AG
All Rights Reserved.**

Legal Disclaimer

The information given in this document shall in no event be regarded as a guarantee of conditions or characteristics. With respect to any examples or hints given herein, any typical values stated herein and/or any information regarding the application of the device, Infineon Technologies hereby disclaims any and all warranties and liabilities of any kind, including without limitation, warranties of non-infringement of intellectual property rights of any third party.

Information

For further information on technology, delivery terms and conditions and prices, please contact the nearest Infineon Technologies Office (www.infineon.com).



Warnings

Due to technical requirements, components may contain dangerous substances. For information on the types in question, please contact the nearest Infineon Technologies Office.

Infineon Technologies components may be used in life-support devices or systems only with the express written approval of Infineon Technologies, if a failure of such components can reasonably be expected to cause the failure of that life-support device or system or to affect the safety or effectiveness of that device or system. Life support devices or systems are intended to be implanted in the human body or to support and/or maintain and sustain and/or protect human life. If they fail, it is reasonable to assume that the health of the user or other persons may be endangered.

Looking for pricing, stock, or lifecycle information?

Click below to explore more details on WIN SOURCE:

-  [View BFN19H6327XTSA1 on WIN SOURCE](#)
-  [Infineon Technologies Information](#)

Optimize Your Supply Chain with WIN SOURCE Solutions

-  Global Sourcing Solution
-  Obsolete Management
-  Cost Control Management
-  Shortage Management
-  Alternative Solution
-  Excess Inventory Management