



**THE DATASHEET OF  
MLG0402Q1N7BT000**



Inductors for high frequency circuits  
Multilayer ceramic  
MLG-Q series



## MLG0402Q type



### FEATURES

- High Q type inductor for high-frequency circuits.
- Inductance range: from 0.2 to 33nH.
- 0.1n step inductance lineup.
- Compared with existing products, the size was greatly reduced, making it optimal for fine-pitch circuits.
- Optimal configuration that greatly improves the Q to 800MHz or higher.
- Advanced monolithic structure is formed using a multilayering and sintering process with ceramic and conductive materials for high-frequency.
- Operating temperature range: -55 to +125°C

### APPLICATION

- Smart phones, tablet terminals, high frequency modules (PAs, VCOs, FEMs , etc.), Bluetooth, W-LAN, UWB, tuners and other high frequency circuits for the mobile communication industry
- Application guides: [Smart phones/tablets](#)

### PART NUMBER CONSTRUCTION

MLG	0402	Q	0N2	B	T	000
Series name	L×W×H dimensions 0.4×0.2×0.2 mm	Characteristics	Inductance (nH)	Inductance tolerance	Packaging style	Internal code

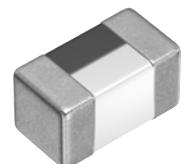

## MLG0402Q type

## CHARACTERISTICS SPECIFICATION TABLE

L (nH)	Q Tolerance	L, Q measuring frequency min. (MHz)	Self-resonant frequency		DC resistance		Rated current (mA)max.	Part No.*	
			(GHz)min.	(GHz)typ.	( $\Omega$ )max.	( $\Omega$ )typ.			
0.2	$\pm 0.1$ nH	—	100	10.0	20.0	0.10	0.03	350	<a href="#">MLG0402Q0N2BT000</a>
0.2	$\pm 0.2$ nH	—	100	10.0	20.0	0.10	0.03	350	<a href="#">MLG0402Q0N2CT000</a>
0.3	$\pm 0.1$ nH	—	100	10.0	18.5	0.20	0.07	350	<a href="#">MLG0402Q0N3BT000</a>
0.3	$\pm 0.2$ nH	—	100	10.0	18.5	0.20	0.07	350	<a href="#">MLG0402Q0N3CT000</a>
0.4	$\pm 0.1$ nH	—	100	10.0	20.0	0.20	0.08	350	<a href="#">MLG0402Q0N4BT000</a>
0.4	$\pm 0.2$ nH	—	100	10.0	20.0	0.20	0.08	350	<a href="#">MLG0402Q0N4CT000</a>
0.5	$\pm 0.1$ nH	—	100	10.0	20.0	0.20	0.11	350	<a href="#">MLG0402Q0N5BT000</a>
0.5	$\pm 0.2$ nH	—	100	10.0	20.0	0.20	0.11	350	<a href="#">MLG0402Q0N5CT000</a>
0.6	$\pm 0.1$ nH	—	100	10.0	20.0	0.30	0.13	320	<a href="#">MLG0402Q0N6BT000</a>
0.6	$\pm 0.2$ nH	—	100	10.0	20.0	0.30	0.13	320	<a href="#">MLG0402Q0N6CT000</a>
0.7	$\pm 0.1$ nH	—	100	10.0	20.0	0.40	0.19	320	<a href="#">MLG0402Q0N7BT000</a>
0.7	$\pm 0.2$ nH	—	100	10.0	20.0	0.40	0.19	320	<a href="#">MLG0402Q0N7CT000</a>
0.8	$\pm 0.1$ nH	—	100	10.0	19.5	0.40	0.11	320	<a href="#">MLG0402Q0N8BT000</a>
0.8	$\pm 0.2$ nH	—	100	10.0	19.5	0.40	0.11	320	<a href="#">MLG0402Q0N8CT000</a>
0.9	$\pm 0.1$ nH	—	100	10.0	20.0	0.40	0.15	320	<a href="#">MLG0402Q0N9BT000</a>
0.9	$\pm 0.2$ nH	—	100	10.0	20.0	0.40	0.15	320	<a href="#">MLG0402Q0N9CT000</a>
1.0	$\pm 0.1$ nH	2	100	10.0	16.8	0.40	0.20	250	<a href="#">MLG0402Q1N0BT000</a>
1.0	$\pm 0.2$ nH	2	100	10.0	16.8	0.40	0.20	250	<a href="#">MLG0402Q1N0CT000</a>
1.0	$\pm 0.3$ nH	2	100	10.0	16.8	0.40	0.20	250	<a href="#">MLG0402Q1N0ST000</a>
1.1	$\pm 0.1$ nH	2	100	10.0	16.6	0.50	0.22	250	<a href="#">MLG0402Q1N1BT000</a>
1.1	$\pm 0.2$ nH	2	100	10.0	16.6	0.50	0.22	250	<a href="#">MLG0402Q1N1CT000</a>
1.1	$\pm 0.3$ nH	2	100	10.0	16.6	0.50	0.22	250	<a href="#">MLG0402Q1N1ST000</a>
1.2	$\pm 0.1$ nH	2	100	10.0	16.2	0.50	0.25	250	<a href="#">MLG0402Q1N2BT000</a>
1.2	$\pm 0.2$ nH	2	100	10.0	16.2	0.50	0.25	250	<a href="#">MLG0402Q1N2CT000</a>
1.2	$\pm 0.3$ nH	2	100	10.0	16.2	0.50	0.25	250	<a href="#">MLG0402Q1N2ST000</a>
1.3	$\pm 0.1$ nH	2	100	10.0	16.0	0.60	0.28	250	<a href="#">MLG0402Q1N3BT000</a>
1.3	$\pm 0.2$ nH	2	100	10.0	16.0	0.60	0.28	250	<a href="#">MLG0402Q1N3CT000</a>
1.3	$\pm 0.3$ nH	2	100	10.0	16.0	0.60	0.28	250	<a href="#">MLG0402Q1N3ST000</a>
1.4	$\pm 0.1$ nH	2	100	10.0	15.8	0.60	0.30	250	<a href="#">MLG0402Q1N4BT000</a>
1.4	$\pm 0.2$ nH	2	100	10.0	15.8	0.60	0.30	250	<a href="#">MLG0402Q1N4CT000</a>
1.4	$\pm 0.3$ nH	2	100	10.0	15.8	0.60	0.30	250	<a href="#">MLG0402Q1N4ST000</a>
1.5	$\pm 0.1$ nH	2	100	10.0	15.6	0.60	0.37	220	<a href="#">MLG0402Q1N5BT000</a>
1.5	$\pm 0.2$ nH	2	100	10.0	15.6	0.60	0.37	220	<a href="#">MLG0402Q1N5CT000</a>
1.5	$\pm 0.3$ nH	2	100	10.0	15.6	0.60	0.37	220	<a href="#">MLG0402Q1N5ST000</a>
1.6	$\pm 0.1$ nH	2	100	10.0	14.4	0.60	0.25	220	<a href="#">MLG0402Q1N6BT000</a>
1.6	$\pm 0.2$ nH	2	100	10.0	14.4	0.60	0.25	220	<a href="#">MLG0402Q1N6CT000</a>
1.6	$\pm 0.3$ nH	2	100	10.0	14.4	0.60	0.25	220	<a href="#">MLG0402Q1N6ST000</a>
1.7	$\pm 0.1$ nH	2	100	10.0	13.4	0.60	0.25	200	<a href="#">MLG0402Q1N7BT000</a>
1.7	$\pm 0.2$ nH	2	100	10.0	13.4	0.60	0.25	200	<a href="#">MLG0402Q1N7CT000</a>
1.7	$\pm 0.3$ nH	2	100	10.0	13.4	0.60	0.25	200	<a href="#">MLG0402Q1N7ST000</a>
1.8	$\pm 0.1$ nH	2	100	10.0	13.9	0.60	0.28	200	<a href="#">MLG0402Q1N8BT000</a>
1.8	$\pm 0.2$ nH	2	100	10.0	13.9	0.60	0.28	200	<a href="#">MLG0402Q1N8CT000</a>
1.8	$\pm 0.3$ nH	2	100	10.0	13.9	0.60	0.28	200	<a href="#">MLG0402Q1N8ST000</a>
1.9	$\pm 0.1$ nH	2	100	9.0	12.2	0.60	0.27	200	<a href="#">MLG0402Q1N9BT000</a>
1.9	$\pm 0.2$ nH	2	100	9.0	12.2	0.60	0.27	200	<a href="#">MLG0402Q1N9CT000</a>
1.9	$\pm 0.3$ nH	2	100	9.0	12.2	0.60	0.27	200	<a href="#">MLG0402Q1N9ST000</a>

\* Please contact us for information on inductance tolerance, G ( $\pm 2\%$ ).

## Measurement equipment

Measurement item	Product No.	Manufacturer
L, Q	4291B+16196D	Keysight Technologies
Self-resonant frequency	8720C	Keysight Technologies
DC resistance	4338A	Keysight Technologies

\* Equivalent measurement equipment may be used.

## MLG0402Q type

## CHARACTERISTICS SPECIFICATION TABLE

L (nH)	Q Tolerance	Q min.	L, Q measuring frequency (MHz)	Self-resonant frequency		DC resistance		Rated current (mA)max.	Part No.*
				(GHz)min.	(GHz)typ.	( $\Omega$ )max.	( $\Omega$ )typ.		
2.0	$\pm 0.1$ nH	2	100	9.0	12.5	0.60	0.30	200	<a href="#">MLG0402Q2N0BT000</a>
2.0	$\pm 0.2$ nH	2	100	9.0	12.5	0.60	0.30	200	<a href="#">MLG0402Q2N0CT000</a>
2.0	$\pm 0.3$ nH	2	100	9.0	12.5	0.60	0.30	200	<a href="#">MLG0402Q2N0ST000</a>
2.1	$\pm 0.1$ nH	2	100	8.0	11.8	0.70	0.36	200	<a href="#">MLG0402Q2N1BT000</a>
2.1	$\pm 0.2$ nH	2	100	8.0	11.8	0.70	0.36	200	<a href="#">MLG0402Q2N1CT000</a>
2.1	$\pm 0.3$ nH	2	100	8.0	11.8	0.70	0.36	200	<a href="#">MLG0402Q2N1ST000</a>
2.2	$\pm 0.1$ nH	2	100	8.0	11.7	0.80	0.43	200	<a href="#">MLG0402Q2N2BT000</a>
2.2	$\pm 0.2$ nH	2	100	8.0	11.7	0.80	0.43	200	<a href="#">MLG0402Q2N2CT000</a>
2.2	$\pm 0.3$ nH	2	100	8.0	11.7	0.80	0.43	200	<a href="#">MLG0402Q2N2ST000</a>
2.3	$\pm 0.1$ nH	2	100	7.0	11.0	0.80	0.46	200	<a href="#">MLG0402Q2N3BT000</a>
2.3	$\pm 0.2$ nH	2	100	7.0	11.0	0.80	0.46	200	<a href="#">MLG0402Q2N3CT000</a>
2.3	$\pm 0.3$ nH	2	100	7.0	11.0	0.80	0.46	200	<a href="#">MLG0402Q2N3ST000</a>
2.4	$\pm 0.1$ nH	2	100	7.0	10.9	0.80	0.43	200	<a href="#">MLG0402Q2N4BT000</a>
2.4	$\pm 0.2$ nH	2	100	7.0	10.9	0.80	0.43	200	<a href="#">MLG0402Q2N4CT000</a>
2.4	$\pm 0.3$ nH	2	100	7.0	10.9	0.80	0.43	200	<a href="#">MLG0402Q2N4ST000</a>
2.5	$\pm 0.1$ nH	2	100	7.0	10.5	0.80	0.54	200	<a href="#">MLG0402Q2N5BT000</a>
2.5	$\pm 0.2$ nH	2	100	7.0	10.5	0.80	0.54	200	<a href="#">MLG0402Q2N5CT000</a>
2.5	$\pm 0.3$ nH	2	100	7.0	10.5	0.80	0.54	200	<a href="#">MLG0402Q2N5ST000</a>
2.6	$\pm 0.1$ nH	2	100	7.0	10.7	0.80	0.54	200	<a href="#">MLG0402Q2N6BT000</a>
2.6	$\pm 0.2$ nH	2	100	7.0	10.7	0.80	0.54	200	<a href="#">MLG0402Q2N6CT000</a>
2.6	$\pm 0.3$ nH	2	100	7.0	10.7	0.80	0.54	200	<a href="#">MLG0402Q2N6ST000</a>
2.7	$\pm 0.1$ nH	2	100	7.0	10.7	0.80	0.54	200	<a href="#">MLG0402Q2N7BT000</a>
2.7	$\pm 0.2$ nH	2	100	7.0	10.7	0.80	0.54	200	<a href="#">MLG0402Q2N7CT000</a>
2.7	$\pm 0.3$ nH	2	100	7.0	10.7	0.80	0.54	200	<a href="#">MLG0402Q2N7ST000</a>
2.8	$\pm 0.1$ nH	2	100	7.0	10.4	0.80	0.56	200	<a href="#">MLG0402Q2N8BT000</a>
2.8	$\pm 0.2$ nH	2	100	7.0	10.4	0.80	0.56	200	<a href="#">MLG0402Q2N8CT000</a>
2.8	$\pm 0.3$ nH	2	100	7.0	10.4	0.80	0.56	200	<a href="#">MLG0402Q2N8ST000</a>
2.9	$\pm 0.1$ nH	2	100	7.0	10.0	0.80	0.52	200	<a href="#">MLG0402Q2N9BT000</a>
2.9	$\pm 0.2$ nH	2	100	7.0	10.0	0.80	0.52	200	<a href="#">MLG0402Q2N9CT000</a>
2.9	$\pm 0.3$ nH	2	100	7.0	10.0	0.80	0.52	200	<a href="#">MLG0402Q2N9ST000</a>
3.0	$\pm 0.1$ nH	2	100	7.0	10.0	0.80	0.45	200	<a href="#">MLG0402Q3N0BT000</a>
3.0	$\pm 0.2$ nH	2	100	7.0	10.0	0.80	0.45	200	<a href="#">MLG0402Q3N0CT000</a>
3.0	$\pm 0.3$ nH	2	100	7.0	10.0	0.80	0.45	200	<a href="#">MLG0402Q3N0ST000</a>
3.1	$\pm 0.1$ nH	2	100	7.0	9.7	0.90	0.58	200	<a href="#">MLG0402Q3N1BT000</a>
3.1	$\pm 0.2$ nH	2	100	7.0	9.7	0.90	0.58	200	<a href="#">MLG0402Q3N1CT000</a>
3.1	$\pm 0.3$ nH	2	100	7.0	9.7	0.90	0.58	200	<a href="#">MLG0402Q3N1ST000</a>
3.2	$\pm 0.1$ nH	2	100	7.0	9.4	1.00	0.66	200	<a href="#">MLG0402Q3N2BT000</a>
3.2	$\pm 0.2$ nH	2	100	7.0	9.4	1.00	0.66	200	<a href="#">MLG0402Q3N2CT000</a>
3.2	$\pm 0.3$ nH	2	100	7.0	9.4	1.00	0.66	200	<a href="#">MLG0402Q3N2ST000</a>
3.3	$\pm 0.1$ nH	2	100	7.0	10.0	1.10	0.73	180	<a href="#">MLG0402Q3N3BT000</a>
3.3	$\pm 0.2$ nH	2	100	7.0	10.0	1.10	0.73	180	<a href="#">MLG0402Q3N3CT000</a>
3.3	$\pm 0.3$ nH	2	100	7.0	10.0	1.10	0.73	180	<a href="#">MLG0402Q3N3ST000</a>
3.4	$\pm 0.1$ nH	2	100	6.5	9.1	1.10	0.73	180	<a href="#">MLG0402Q3N4BT000</a>
3.4	$\pm 0.2$ nH	2	100	6.5	9.1	1.10	0.73	180	<a href="#">MLG0402Q3N4CT000</a>
3.4	$\pm 0.3$ nH	2	100	6.5	9.1	1.10	0.73	180	<a href="#">MLG0402Q3N4ST000</a>
3.5	$\pm 0.1$ nH	2	100	6.0	9.0	1.10	0.74	180	<a href="#">MLG0402Q3N5BT000</a>
3.5	$\pm 0.2$ nH	2	100	6.0	9.0	1.10	0.74	180	<a href="#">MLG0402Q3N5CT000</a>
3.5	$\pm 0.3$ nH	2	100	6.0	9.0	1.10	0.74	180	<a href="#">MLG0402Q3N5ST000</a>

\* Please contact us for information on inductance tolerance, G ( $\pm 2\%$ ).

## Measurement equipment

Measurement item	Product No.	Manufacturer
L, Q	4291B+16196D	Keysight Technologies
Self-resonant frequency	8720C	Keysight Technologies
DC resistance	4338A	Keysight Technologies

\* Equivalent measurement equipment may be used.

## MLG0402Q type

## CHARACTERISTICS SPECIFICATION TABLE

L (nH)	Q Tolerance	Q min.	L, Q measuring frequency (MHz)	Self-resonant frequency		DC resistance		Rated current (mA)max.	Part No.*
				(GHz)min.	(GHz)typ.	( $\Omega$ )max.	( $\Omega$ )typ.		
3.6	$\pm 0.1$ nH	2	100	6.0	9.0	1.10	0.75	180	<a href="#">MLG0402Q3N6BT000</a>
3.6	$\pm 0.2$ nH	2	100	6.0	9.0	1.10	0.75	180	<a href="#">MLG0402Q3N6CT000</a>
3.6	$\pm 0.3$ nH	2	100	6.0	9.0	1.10	0.75	180	<a href="#">MLG0402Q3N6ST000</a>
3.7	$\pm 0.1$ nH	2	100	6.0	8.9	1.10	0.73	180	<a href="#">MLG0402Q3N7BT000</a>
3.7	$\pm 0.2$ nH	2	100	6.0	8.9	1.10	0.73	180	<a href="#">MLG0402Q3N7CT000</a>
3.7	$\pm 0.3$ nH	2	100	6.0	8.9	1.10	0.73	180	<a href="#">MLG0402Q3N7ST000</a>
3.8	$\pm 0.1$ nH	2	100	6.0	8.4	1.10	0.70	180	<a href="#">MLG0402Q3N8BT000</a>
3.8	$\pm 0.2$ nH	2	100	6.0	8.4	1.10	0.70	180	<a href="#">MLG0402Q3N8CT000</a>
3.8	$\pm 0.3$ nH	2	100	6.0	8.4	1.10	0.70	180	<a href="#">MLG0402Q3N8ST000</a>
3.9	$\pm 0.1$ nH	2	100	6.0	8.8	1.20	0.77	180	<a href="#">MLG0402Q3N9BT000</a>
3.9	$\pm 0.2$ nH	2	100	6.0	8.8	1.20	0.77	180	<a href="#">MLG0402Q3N9CT000</a>
3.9	$\pm 0.3$ nH	2	100	6.0	8.8	1.20	0.77	180	<a href="#">MLG0402Q3N9ST000</a>
4.0	$\pm 0.1$ nH	2	100	6.0	8.4	1.20	0.71	180	<a href="#">MLG0402Q4N0BT000</a>
4.0	$\pm 0.2$ nH	2	100	6.0	8.4	1.20	0.71	180	<a href="#">MLG0402Q4N0CT000</a>
4.0	$\pm 0.3$ nH	2	100	6.0	8.4	1.20	0.71	180	<a href="#">MLG0402Q4N0ST000</a>
4.3	$\pm 0.3$ nH	2	100	6.0	8.6	1.20	0.77	180	<a href="#">MLG0402Q4N3ST000</a>
4.3	$\pm 3\%$	2	100	6.0	8.6	1.20	0.77	180	<a href="#">MLG0402Q4N3HT000</a>
4.7	$\pm 0.3$ nH	2	100	6.0	8.1	1.30	0.88	160	<a href="#">MLG0402Q4N7ST000</a>
4.7	$\pm 3\%$	2	100	6.0	8.1	1.30	0.88	160	<a href="#">MLG0402Q4N7HT000</a>
5.1	$\pm 0.3$ nH	2	100	6.0	7.8	1.40	0.90	160	<a href="#">MLG0402Q5N1ST000</a>
5.1	$\pm 3\%$	2	100	6.0	7.8	1.40	0.90	160	<a href="#">MLG0402Q5N1HT000</a>
5.6	$\pm 0.3$ nH	2	100	6.0	7.8	1.50	1.02	140	<a href="#">MLG0402Q5N6ST000</a>
5.6	$\pm 3\%$	2	100	6.0	7.8	1.50	1.02	140	<a href="#">MLG0402Q5N6HT000</a>
6.2	$\pm 0.3$ nH	2	100	5.5	7.2	1.50	1.04	140	<a href="#">MLG0402Q6N2ST000</a>
6.2	$\pm 3\%$	2	100	5.5	7.2	1.50	1.04	140	<a href="#">MLG0402Q6N2HT000</a>
6.8	$\pm 3\%$	2	100	5.5	6.9	1.60	1.12	140	<a href="#">MLG0402Q6N8HT000</a>
6.8	$\pm 5\%$	2	100	5.5	6.9	1.60	1.12	140	<a href="#">MLG0402Q6N8JT000</a>
7.5	$\pm 3\%$	2	100	5.0	6.7	1.70	1.13	140	<a href="#">MLG0402Q7N5HT000</a>
7.5	$\pm 5\%$	2	100	5.0	6.7	1.70	1.13	140	<a href="#">MLG0402Q7N5JT000</a>
8.2	$\pm 3\%$	2	100	4.5	6.2	1.80	1.16	140	<a href="#">MLG0402Q8N2HT000</a>
8.2	$\pm 5\%$	2	100	4.5	6.2	1.80	1.16	140	<a href="#">MLG0402Q8N2JT000</a>
9.1	$\pm 3\%$	2	100	4.0	5.7	1.80	1.20	140	<a href="#">MLG0402Q9N1HT000</a>
9.1	$\pm 5\%$	2	100	4.0	5.7	1.80	1.20	140	<a href="#">MLG0402Q9N1JT000</a>
10.0	$\pm 3\%$	3	100	4.0	5.3	2.10	1.45	140	<a href="#">MLG0402Q10NHT000</a>
10.0	$\pm 5\%$	3	100	4.0	5.3	2.10	1.45	140	<a href="#">MLG0402Q10NJT000</a>
12.0	$\pm 3\%$	3	100	3.5	4.8	2.40	1.64	140	<a href="#">MLG0402Q12NHT000</a>
12.0	$\pm 5\%$	3	100	3.5	4.8	2.40	1.64	140	<a href="#">MLG0402Q12NJT000</a>
15.0	$\pm 3\%$	3	100	3.0	4.5	2.60	1.77	140	<a href="#">MLG0402Q15NHT000</a>
15.0	$\pm 5\%$	3	100	3.0	4.5	2.60	1.77	140	<a href="#">MLG0402Q15NJT000</a>
18.0	$\pm 3\%$	3	100	2.5	3.0	2.80	1.94	140	<a href="#">MLG0402Q18NHT000</a>
18.0	$\pm 5\%$	3	100	2.5	3.0	2.80	1.94	140	<a href="#">MLG0402Q18NJT000</a>
22.0	$\pm 3\%$	3	100	2.2	2.7	3.20	2.18	130	<a href="#">MLG0402Q22NHT000</a>
22.0	$\pm 5\%$	3	100	2.2	2.7	3.20	2.18	130	<a href="#">MLG0402Q22NJT000</a>
27.0	$\pm 3\%$	3	100	1.9	2.5	3.50	2.44	120	<a href="#">MLG0402Q27NHT000</a>
27.0	$\pm 5\%$	3	100	1.9	2.5	3.50	2.44	120	<a href="#">MLG0402Q27NJT000</a>
33.0	$\pm 3\%$	3	100	1.7	2.2	3.80	2.71	120	<a href="#">MLG0402Q33NHT000</a>
33.0	$\pm 5\%$	3	100	1.7	2.2	3.80	2.71	120	<a href="#">MLG0402Q33NJT000</a>

\* Please contact us for information on inductance tolerance, G ( $\pm 2\%$ ).

## Measurement equipment

Measurement item	Product No.	Manufacturer
L, Q	4291B+16196D	Keysight Technologies
Self-resonant frequency	8720C	Keysight Technologies
DC resistance	4338A	Keysight Technologies

\* Equivalent measurement equipment may be used.

## MLG0402Q type

## L, Q FREQUENCY CHARACTERISTICS TABLE

L(nH)typ.					Q typ.					Part No.*
500MHz	800MHz	1.8GHz	2.0GHz	2.4GHz	500MHz	800MHz	1.8GHz	2.0GHz	2.4GHz	
0.2	0.2	0.2	0.2	0.2	8	11	18	20	23	<a href="#">MLG0402Q0N2BT000</a>
0.2	0.2	0.2	0.2	0.2	8	11	18	20	23	<a href="#">MLG0402Q0N2CT000</a>
0.3	0.3	0.3	0.3	0.3	7	9	15	16	19	<a href="#">MLG0402Q0N3BT000</a>
0.3	0.3	0.3	0.3	0.3	7	9	15	16	19	<a href="#">MLG0402Q0N3CT000</a>
0.4	0.4	0.4	0.4	0.3	9	12	19	20	22	<a href="#">MLG0402Q0N4BT000</a>
0.4	0.4	0.4	0.4	0.3	9	12	19	20	22	<a href="#">MLG0402Q0N4CT000</a>
0.5	0.5	0.4	0.4	0.4	9	12	19	21	23	<a href="#">MLG0402Q0N5BT000</a>
0.5	0.5	0.4	0.4	0.4	9	12	19	21	23	<a href="#">MLG0402Q0N5CT000</a>
0.6	0.5	0.5	0.5	0.5	7	11	17	18	20	<a href="#">MLG0402Q0N6BT000</a>
0.6	0.5	0.5	0.5	0.5	7	11	17	18	20	<a href="#">MLG0402Q0N6CT000</a>
0.7	0.7	0.6	0.6	0.6	8	11	18	19	22	<a href="#">MLG0402Q0N7BT000</a>
0.7	0.7	0.7	0.7	0.7	9	12	20	21	24	<a href="#">MLG0402Q0N8BT000</a>
0.7	0.7	0.6	0.6	0.6	8	11	18	19	22	<a href="#">MLG0402Q0N7CT000</a>
0.7	0.7	0.7	0.7	0.7	9	12	20	21	24	<a href="#">MLG0402Q0N8CT000</a>
0.8	0.8	0.8	0.8	0.8	10	13	21	23	26	<a href="#">MLG0402Q0N9BT000</a>
0.8	0.8	0.8	0.8	0.8	10	13	21	23	26	<a href="#">MLG0402Q0N9CT000</a>
0.9	0.9	0.9	0.9	0.9	10	12	20	22	25	<a href="#">MLG0402Q1N0BT000</a>
0.9	0.9	0.9	0.9	0.9	10	12	20	22	25	<a href="#">MLG0402Q1N0CT000</a>
0.9	0.9	0.9	0.9	0.9	10	12	20	22	25	<a href="#">MLG0402Q1N0ST000</a>
1.0	1.0	1.0	1.0	1.0	9	12	20	22	25	<a href="#">MLG0402Q1N1BT000</a>
1.0	1.0	1.0	1.0	1.0	9	12	20	22	25	<a href="#">MLG0402Q1N1CT000</a>
1.0	1.0	1.0	1.0	1.0	9	12	20	22	25	<a href="#">MLG0402Q1N1ST000</a>
1.1	1.1	1.1	1.1	1.1	9	12	20	21	24	<a href="#">MLG0402Q1N2BT000</a>
1.1	1.1	1.1	1.1	1.1	9	12	20	21	24	<a href="#">MLG0402Q1N2CT000</a>
1.1	1.1	1.1	1.1	1.1	9	12	20	21	24	<a href="#">MLG0402Q1N2ST000</a>
1.2	1.2	1.2	1.2	1.2	9	12	20	22	25	<a href="#">MLG0402Q1N3BT000</a>
1.2	1.2	1.2	1.2	1.2	9	12	20	22	25	<a href="#">MLG0402Q1N3CT000</a>
1.2	1.2	1.2	1.2	1.2	9	12	20	22	25	<a href="#">MLG0402Q1N3ST000</a>
1.3	1.3	1.3	1.3	1.3	9	12	20	22	25	<a href="#">MLG0402Q1N4BT000</a>
1.3	1.3	1.3	1.3	1.3	9	12	20	22	25	<a href="#">MLG0402Q1N4CT000</a>
1.3	1.3	1.3	1.3	1.3	9	12	20	22	25	<a href="#">MLG0402Q1N4ST000</a>
1.4	1.4	1.4	1.4	1.4	9	12	19	21	23	<a href="#">MLG0402Q1N5BT000</a>
1.4	1.4	1.4	1.4	1.4	9	12	19	21	23	<a href="#">MLG0402Q1N5CT000</a>
1.4	1.4	1.4	1.4	1.4	9	12	19	21	23	<a href="#">MLG0402Q1N5ST000</a>
1.5	1.5	1.4	1.4	1.4	10	13	22	23	26	<a href="#">MLG0402Q1N6BT000</a>
1.5	1.5	1.4	1.4	1.4	10	13	22	23	26	<a href="#">MLG0402Q1N6CT000</a>
1.5	1.5	1.4	1.4	1.4	10	13	22	23	26	<a href="#">MLG0402Q1N6ST000</a>
1.6	1.5	1.5	1.5	1.5	10	13	21	23	25	<a href="#">MLG0402Q1N7BT000</a>
1.6	1.5	1.5	1.5	1.5	10	13	21	23	25	<a href="#">MLG0402Q1N7CT000</a>
1.6	1.5	1.5	1.5	1.5	10	13	21	23	25	<a href="#">MLG0402Q1N7ST000</a>
1.7	1.6	1.6	1.6	1.6	11	14	22	24	27	<a href="#">MLG0402Q1N8BT000</a>
1.7	1.6	1.6	1.6	1.6	11	14	22	24	27	<a href="#">MLG0402Q1N8CT000</a>
1.7	1.6	1.6	1.6	1.6	11	14	22	24	27	<a href="#">MLG0402Q1N8ST000</a>

\* Please contact us for information on inductance tolerance, G ( $\pm 2\%$ ).

## Measurement equipment

Product No.	Manufacturer
4291B+16196D	Keysight Technologies

\* Equivalent measurement equipment may be used.

## MLG0402Q type

## L, Q FREQUENCY CHARACTERISTICS TABLE

L(nH)typ.					Q typ.					Part No.*
500MHz	800MHz	1.8GHz	2.0GHz	2.4GHz	500MHz	800MHz	1.8GHz	2.0GHz	2.4GHz	
1.8	1.8	1.7	1.7	1.7	10	14	22	24	27	<a href="#">MLG0402Q1N9BT000</a>
1.8	1.8	1.7	1.7	1.7	10	14	22	24	27	<a href="#">MLG0402Q1N9CT000</a>
1.8	1.8	1.7	1.7	1.7	10	14	22	24	27	<a href="#">MLG0402Q1N9ST000</a>
1.9	1.8	1.8	1.8	1.8	10	13	21	23	26	<a href="#">MLG0402Q2N0BT000</a>
1.9	1.8	1.8	1.8	1.8	10	13	21	23	26	<a href="#">MLG0402Q2N0CT000</a>
1.9	1.8	1.8	1.8	1.8	10	13	21	23	26	<a href="#">MLG0402Q2N0ST000</a>
2.0	2.0	1.9	1.9	1.9	10	14	22	24	27	<a href="#">MLG0402Q2N1BT000</a>
2.0	2.0	1.9	1.9	1.9	10	14	22	24	27	<a href="#">MLG0402Q2N1CT000</a>
2.0	2.0	1.9	1.9	1.9	10	14	22	24	27	<a href="#">MLG0402Q2N1ST000</a>
2.1	2.1	2.0	2.0	2.0	10	14	22	24	27	<a href="#">MLG0402Q2N2BT000</a>
2.1	2.1	2.0	2.0	2.0	10	14	22	24	27	<a href="#">MLG0402Q2N2CT000</a>
2.1	2.1	2.0	2.0	2.0	10	14	22	24	27	<a href="#">MLG0402Q2N2ST000</a>
2.2	2.2	2.1	2.1	2.2	10	13	21	23	25	<a href="#">MLG0402Q2N3BT000</a>
2.2	2.2	2.1	2.1	2.2	10	13	21	23	25	<a href="#">MLG0402Q2N3CT000</a>
2.2	2.2	2.1	2.1	2.2	10	13	21	23	25	<a href="#">MLG0402Q2N3ST000</a>
2.3	2.3	2.2	2.2	2.2	9	13	21	22	25	<a href="#">MLG0402Q2N4BT000</a>
2.3	2.3	2.2	2.2	2.2	9	13	21	22	25	<a href="#">MLG0402Q2N4CT000</a>
2.3	2.3	2.2	2.2	2.2	9	13	21	22	25	<a href="#">MLG0402Q2N4ST000</a>
2.4	2.4	2.3	2.3	2.4	10	13	21	22	25	<a href="#">MLG0402Q2N5BT000</a>
2.4	2.4	2.3	2.3	2.4	10	13	21	22	25	<a href="#">MLG0402Q2N5CT000</a>
2.4	2.4	2.3	2.3	2.4	10	13	21	22	25	<a href="#">MLG0402Q2N5ST000</a>
2.5	2.5	2.4	2.4	2.4	10	13	20	22	24	<a href="#">MLG0402Q2N6BT000</a>
2.5	2.5	2.4	2.4	2.4	10	13	20	22	24	<a href="#">MLG0402Q2N6CT000</a>
2.5	2.5	2.4	2.4	2.4	10	13	20	22	24	<a href="#">MLG0402Q2N6ST000</a>
2.5	2.5	2.5	2.5	2.5	10	13	21	23	25	<a href="#">MLG0402Q2N7BT000</a>
2.5	2.5	2.5	2.5	2.5	10	13	21	23	25	<a href="#">MLG0402Q2N7CT000</a>
2.5	2.5	2.5	2.5	2.5	10	13	21	23	25	<a href="#">MLG0402Q2N7ST000</a>
2.6	2.6	2.6	2.6	2.6	10	13	20	22	24	<a href="#">MLG0402Q2N8BT000</a>
2.6	2.6	2.6	2.6	2.6	10	13	20	22	24	<a href="#">MLG0402Q2N8CT000</a>
2.6	2.6	2.6	2.6	2.6	10	13	20	22	24	<a href="#">MLG0402Q2N8ST000</a>
2.7	2.7	2.7	2.7	2.7	10	13	20	21	23	<a href="#">MLG0402Q2N9BT000</a>
2.7	2.7	2.7	2.7	2.7	10	13	20	21	23	<a href="#">MLG0402Q2N9CT000</a>
2.7	2.7	2.7	2.7	2.7	10	13	20	21	23	<a href="#">MLG0402Q2N9ST000</a>
2.8	2.8	2.7	2.7	2.8	10	13	20	21	23	<a href="#">MLG0402Q3N0BT000</a>
2.8	2.8	2.7	2.7	2.8	10	13	20	21	23	<a href="#">MLG0402Q3N0CT000</a>
2.8	2.8	2.7	2.7	2.8	10	13	20	21	23	<a href="#">MLG0402Q3N0ST000</a>
2.9	2.9	2.9	2.9	2.9	9	12	19	21	23	<a href="#">MLG0402Q3N1BT000</a>
2.9	2.9	2.9	2.9	2.9	9	12	19	21	23	<a href="#">MLG0402Q3N1CT000</a>
2.9	2.9	2.9	2.9	2.9	9	12	19	21	23	<a href="#">MLG0402Q3N1ST000</a>
3.0	3.0	3.0	3.0	3.0	9	12	19	20	22	<a href="#">MLG0402Q3N2BT000</a>
3.0	3.0	3.0	3.0	3.0	9	12	19	20	22	<a href="#">MLG0402Q3N2CT000</a>
3.0	3.0	3.0	3.0	3.0	9	12	19	20	22	<a href="#">MLG0402Q3N2ST000</a>

\* Please contact us for information on inductance tolerance, G ( $\pm 2\%$ ).

## Measurement equipment

Product No.	Manufacturer
4291B+16196D	Keysight Technologies

\* Equivalent measurement equipment may be used.

## MLG0402Q type

## L, Q FREQUENCY CHARACTERISTICS TABLE

L(nH)typ.					Q typ.					Part No.*
500MHz	800MHz	1.8GHz	2.0GHz	2.4GHz	500MHz	800MHz	1.8GHz	2.0GHz	2.4GHz	
3.2	3.1	3.1	3.1	3.1	9	12	19	21	23	<a href="#">MLG0402Q3N3BT000</a>
3.2	3.1	3.1	3.1	3.1	9	12	19	21	23	<a href="#">MLG0402Q3N3CT000</a>
3.2	3.1	3.1	3.1	3.1	9	12	19	21	23	<a href="#">MLG0402Q3N3ST000</a>
3.2	3.2	3.2	3.2	3.2	9	12	19	20	22	<a href="#">MLG0402Q3N4BT000</a>
3.2	3.2	3.2	3.2	3.2	9	12	19	20	22	<a href="#">MLG0402Q3N4CT000</a>
3.2	3.2	3.2	3.2	3.2	9	12	19	20	22	<a href="#">MLG0402Q3N4ST000</a>
3.3	3.3	3.3	3.3	3.3	9	12	19	20	22	<a href="#">MLG0402Q3N5BT000</a>
3.3	3.3	3.3	3.3	3.3	9	12	19	20	22	<a href="#">MLG0402Q3N5CT000</a>
3.3	3.3	3.3	3.3	3.3	9	12	19	20	22	<a href="#">MLG0402Q3N5ST000</a>
3.4	3.4	3.4	3.4	3.4	10	13	20	22	24	<a href="#">MLG0402Q3N6BT000</a>
3.4	3.4	3.4	3.4	3.4	10	13	20	22	24	<a href="#">MLG0402Q3N6CT000</a>
3.4	3.4	3.4	3.4	3.4	10	13	20	22	24	<a href="#">MLG0402Q3N6ST000</a>
3.5	3.5	3.4	3.5	3.5	9	12	19	21	23	<a href="#">MLG0402Q3N7BT000</a>
3.5	3.5	3.4	3.5	3.5	9	12	19	21	23	<a href="#">MLG0402Q3N7CT000</a>
3.5	3.5	3.4	3.5	3.5	9	12	19	21	23	<a href="#">MLG0402Q3N7ST000</a>
3.6	3.6	3.5	3.6	3.6	10	13	19	21	23	<a href="#">MLG0402Q3N8BT000</a>
3.6	3.6	3.5	3.6	3.6	10	13	19	21	23	<a href="#">MLG0402Q3N8CT000</a>
3.6	3.6	3.5	3.6	3.6	10	13	19	21	23	<a href="#">MLG0402Q3N8ST000</a>
3.7	3.7	3.7	3.7	3.7	9	12	19	20	22	<a href="#">MLG0402Q3N9BT000</a>
3.7	3.7	3.7	3.7	3.7	9	12	19	20	22	<a href="#">MLG0402Q3N9CT000</a>
3.7	3.7	3.7	3.7	3.7	9	12	19	20	22	<a href="#">MLG0402Q3N9ST000</a>
3.8	3.8	3.7	3.8	3.8	9	12	19	20	22	<a href="#">MLG0402Q4N0BT000</a>
3.8	3.8	3.7	3.8	3.8	9	12	19	20	22	<a href="#">MLG0402Q4N0CT000</a>
3.8	3.8	3.7	3.8	3.8	9	12	19	20	22	<a href="#">MLG0402Q4N0ST000</a>
4.1	4.0	4.0	4.0	4.1	10	13	21	23	25	<a href="#">MLG0402Q4N3ST000</a>
4.1	4.0	4.0	4.0	4.1	10	13	21	23	25	<a href="#">MLG0402Q4N3HT000</a>
4.5	4.5	4.5	4.5	4.6	10	13	21	23	25	<a href="#">MLG0402Q4N7ST000</a>
4.5	4.5	4.5	4.5	4.6	10	13	21	23	25	<a href="#">MLG0402Q4N7HT000</a>
4.8	4.8	4.8	4.8	4.9	10	13	20	22	24	<a href="#">MLG0402Q5N1ST000</a>
4.8	4.8	4.8	4.8	4.9	10	13	20	22	24	<a href="#">MLG0402Q5N1HT000</a>
5.3	5.3	5.3	5.3	5.4	11	14	22	23	25	<a href="#">MLG0402Q5N6ST000</a>
5.3	5.3	5.3	5.3	5.4	11	14	22	23	25	<a href="#">MLG0402Q5N6HT000</a>
5.9	5.8	5.9	5.9	6.0	11	14	21	23	25	<a href="#">MLG0402Q6N2ST000</a>
5.9	5.8	5.9	5.9	6.0	11	14	21	23	25	<a href="#">MLG0402Q6N2HT000</a>
6.5	6.4	6.5	6.6	6.7	10	13	21	22	23	<a href="#">MLG0402Q6N8HT000</a>
6.5	6.4	6.5	6.6	6.7	10	13	21	22	23	<a href="#">MLG0402Q6N8JT000</a>
7.1	7.0	7.1	7.2	7.4	11	14	22	23	25	<a href="#">MLG0402Q7N5HT000</a>
7.1	7.0	7.1	7.2	7.4	11	14	22	23	25	<a href="#">MLG0402Q7N5JT000</a>
7.8	7.8	7.9	8.0	8.3	11	14	21	23	24	<a href="#">MLG0402Q8N2HT000</a>
7.8	7.8	7.9	8.0	8.3	11	14	21	23	24	<a href="#">MLG0402Q8N2JT000</a>
8.6	8.5	8.7	8.8	9.1	11	14	21	23	24	<a href="#">MLG0402Q9N1HT000</a>
8.6	8.5	8.7	8.8	9.1	11	14	21	23	24	<a href="#">MLG0402Q9N1JT000</a>

\* Please contact us for information on inductance tolerance, G ( $\pm 2\%$ ).

## Measurement equipment

Product No.	Manufacturer
4291B+16196D	Keysight Technologies

\* Equivalent measurement equipment may be used.

# MLG0402Q type

## L, Q FREQUENCY CHARACTERISTICS TABLE

L(nH)typ.					Q typ.					Part No.*
500MHz	800MHz	1.8GHz	2.0GHz	2.4GHz	500MHz	800MHz	1.8GHz	2.0GHz	2.4GHz	
9.5	9.5	9.8	9.9	10.3	11	14	21	22	23	<a href="#">MLG0402Q10NHT000</a>
9.5	9.5	9.8	9.9	10.3	11	14	21	22	23	<a href="#">MLG0402Q10NJT000</a>
11.4	11.4	11.9	12.2	12.8	11	13	20	21	21	<a href="#">MLG0402Q12NHT000</a>
11.4	11.4	11.9	12.2	12.8	11	13	20	21	21	<a href="#">MLG0402Q12NJT000</a>
14.1	14.0	14.8	15.2	16.2	11	14	20	21	21	<a href="#">MLG0402Q15NHT000</a>
14.1	14.0	14.8	15.2	16.2	11	14	20	21	21	<a href="#">MLG0402Q15NJT000</a>
17.0	17.2	21.3	23.3	29.2	11	13	16	16	13	<a href="#">MLG0402Q18NHT000</a>
17.0	17.2	21.3	23.3	29.2	11	13	16	16	13	<a href="#">MLG0402Q18NJT000</a>
20.7	21.1	28.1	32.0	45.2	10	12	13	12	9	<a href="#">MLG0402Q22NHT000</a>
20.7	21.1	28.1	32.0	45.2	10	12	13	12	9	<a href="#">MLG0402Q22NJT000</a>
25.3	25.7	34.1	38.9		10	12	12	11		<a href="#">MLG0402Q27NHT000</a>
25.3	25.7	34.1	38.9		10	12	12	11		<a href="#">MLG0402Q27NJT000</a>
31.0	32.2	52.2			10	12	10			<a href="#">MLG0402Q33NHT000</a>
31.0	32.2	52.2			10	12	10			<a href="#">MLG0402Q33NJT000</a>

\* Please contact us for information on inductance tolerance, G ( $\pm 2\%$ ).

### Measurement equipment

Product No.	Manufacturer
4291B+16196D	Keysight Technologies

\* Equivalent measurement equipment may be used.

# MLG0402Q type

## L FREQUENCY CHARACTERISTICS (EXAMPLE)

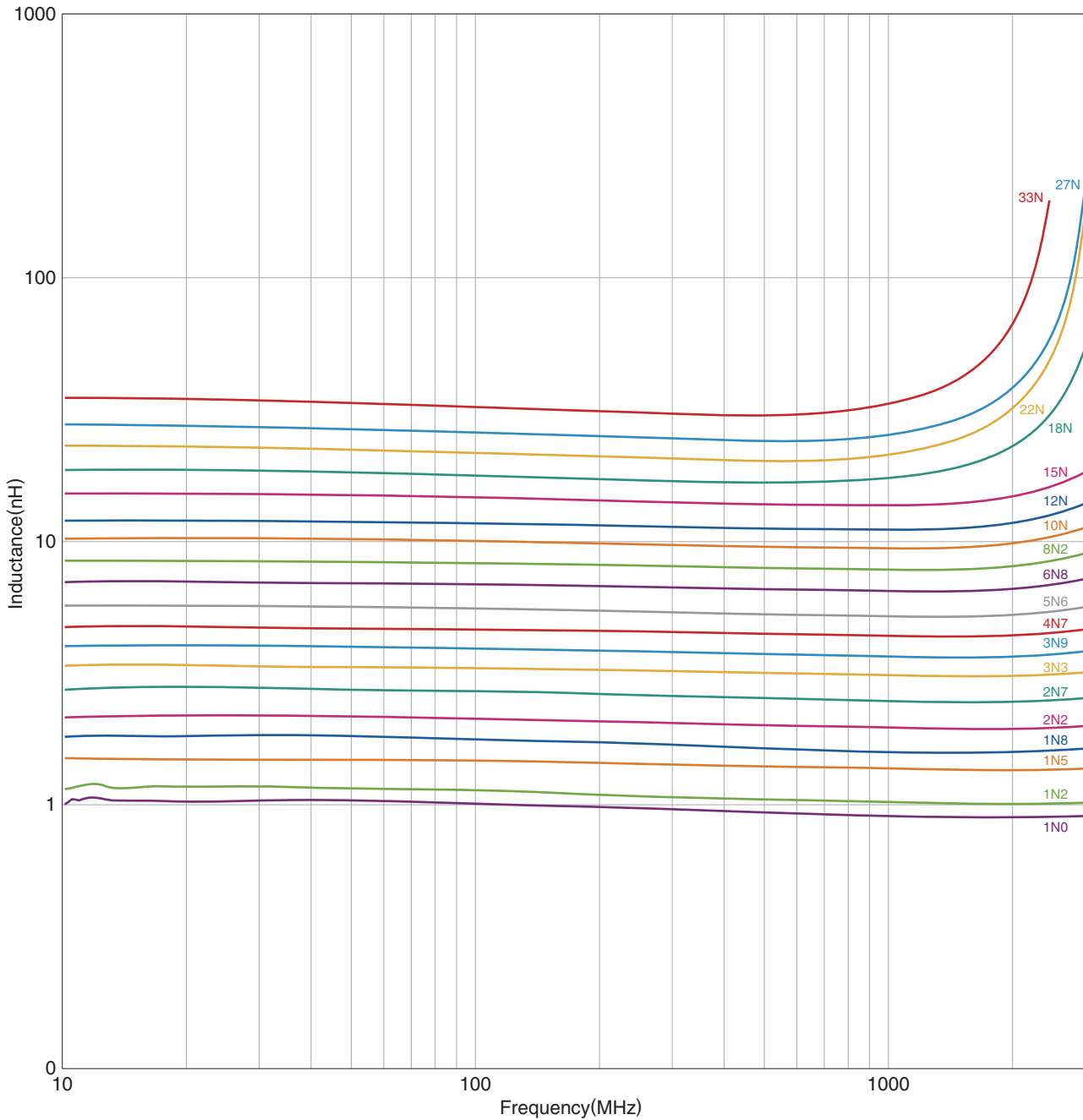

Measurement equipment

Product No.	Manufacturer
E4991A+16196D	Keysight Technologies

\* Equivalent measurement equipment may be used.

# MLG0402Q type

## Q FREQUENCY CHARACTERISTICS (EXAMPLE)

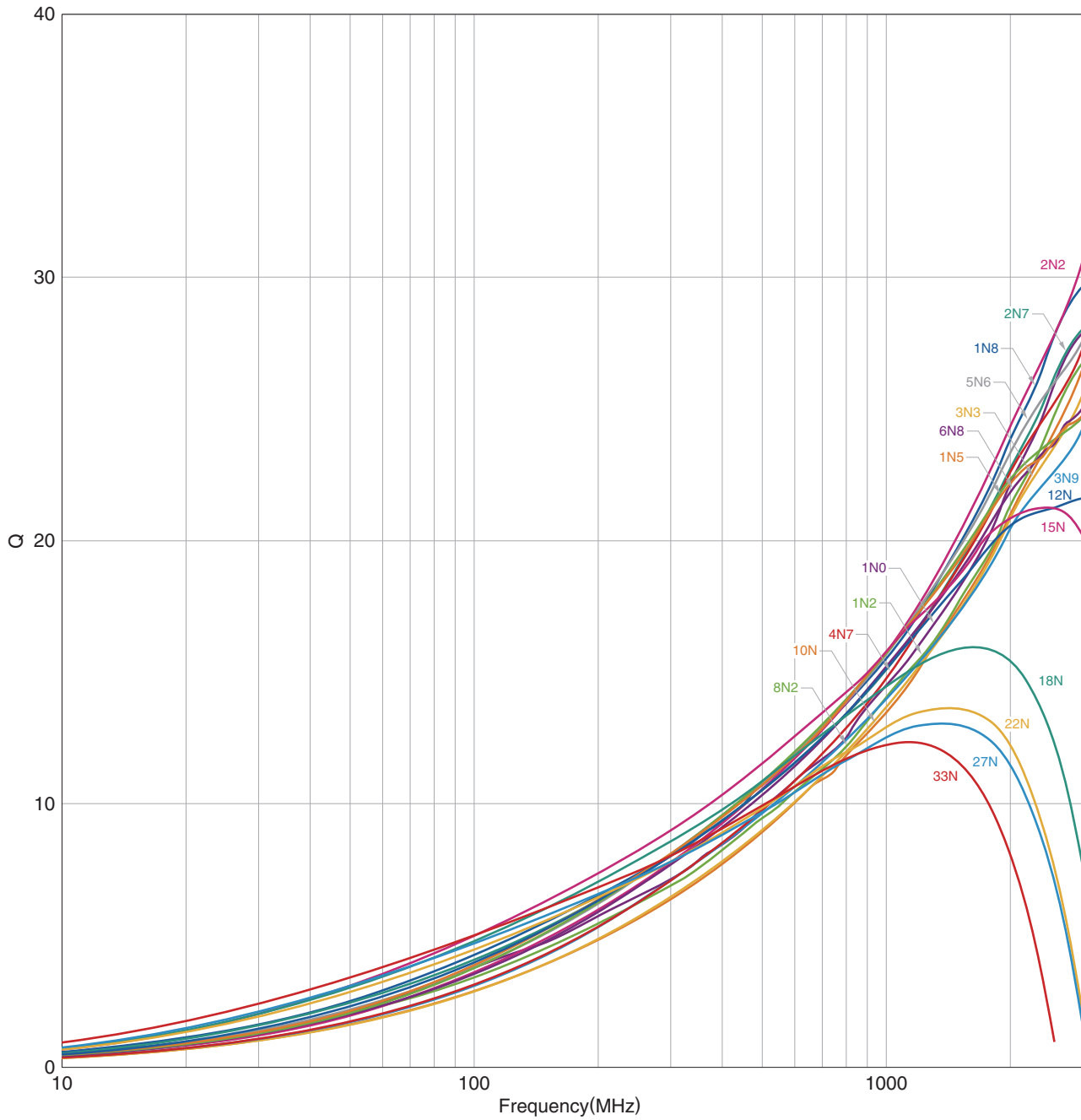

Measurement equipment

Product No.	Manufacturer
E4991A+16196D	Keysight Technologies

\* Equivalent measurement equipment may be used.

# MLG0402Q type

## SHAPE & DIMENSIONS

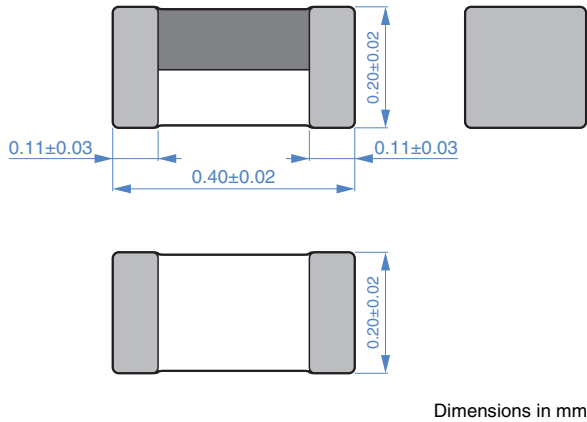

## PACKAGING STYLE

### REEL DIMENSIONS

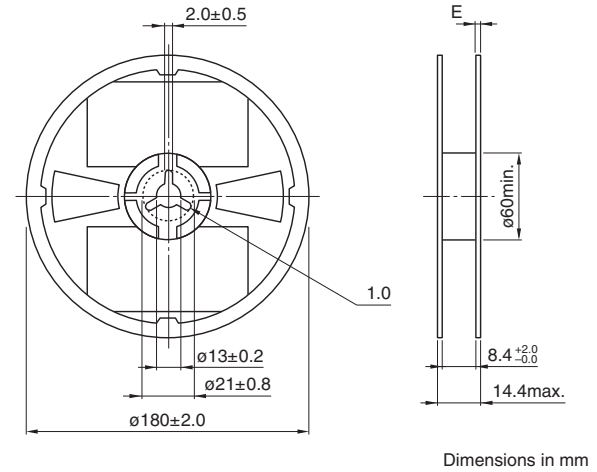

## RECOMMENDED LAND PATTERN

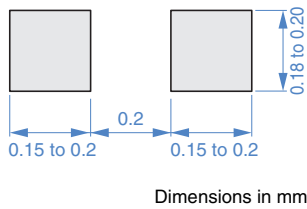

### TAPE DIMENSIONS

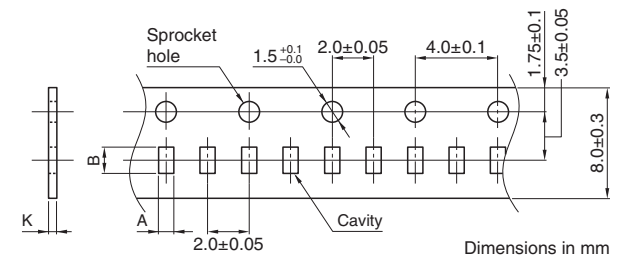

## RECOMMENDED REFLOW PROFILE

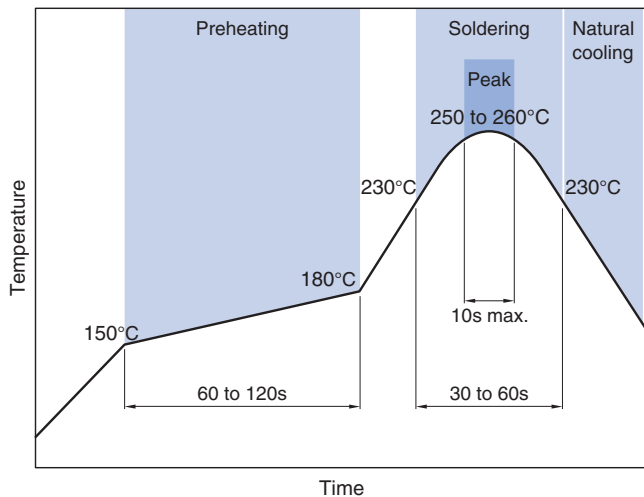

Type	A	B	K
MLG0402Q	0.26±0.04	0.46±0.04	0.4 max.

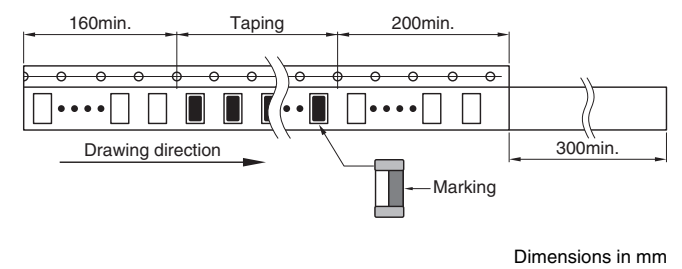

### PACKAGE QUANTITY

Package quantity	20000 pcs/reel
------------------	----------------

## TEMPERATURE RANGE, INDIVIDUAL WEIGHT

Operating temperature range	Storage temperature range*	Individual weight
-55 to +125 °C	-55 to +125 °C	0.07 mg

\* The storage temperature range is for after the assembly.

## REMINDERS FOR USING THESE PRODUCTS

Before using these products, be sure to request the delivery specifications.

### SAFETY REMINDERS

Please pay sufficient attention to the warnings for safe designing when using this products.

#### REMINDERS

- The storage period is less than 12 months. Be sure to follow the storage conditions (temperature: 5 to 40°C, humidity: 10 to 75% RH or less).  
If the storage period elapses, the soldering of the terminal electrodes may deteriorate.
- Do not use or store in locations where there are conditions such as gas corrosion (salt, acid, alkali, etc.).
- Before soldering, be sure to preheat components.  
The preheating temperature should be set so that the temperature difference between the solder temperature and chip temperature does not exceed 150°C.
- Soldering corrections after mounting should be within the range of the conditions determined in the specifications.  
If overheated, a short circuit, performance deterioration, or lifespan shortening may occur.
- When embedding a printed circuit board where a chip is mounted to a set, be sure that residual stress is not given to the chip due to the overall distortion of the printed circuit board and partial distortion such as at screw tightening portions.
- Self heating (temperature increase) occurs when the power is turned ON, so the tolerance should be sufficient for the set thermal design.
- Carefully lay out the coil for the circuit board design of the non-magnetic shield type.  
A malfunction may occur due to magnetic interference.
- Use a wrist band to discharge static electricity in your body through the grounding wire.
- Do not expose the products to magnets or magnetic fields.
- Do not use for a purpose outside of the contents regulated in the delivery specifications.
- The products listed on this catalog are intended for use in general electronic equipment (AV equipment, telecommunications equipment, home appliances, amusement equipment, computer equipment, personal equipment, office equipment, measurement equipment, industrial robots) under a normal operation and use condition.  
The products are not designed or warranted to meet the requirements of the applications listed below, whose performance and/or quality require a more stringent level of safety or reliability, or whose failure, malfunction or trouble could cause serious damage to society, person or property.  
If you intend to use the products in the applications listed below or if you have special requirements exceeding the range or conditions set forth in the each catalog, please contact us.

- (1) Aerospace/aviation equipment
- (2) Transportation equipment (cars, electric trains, ships, etc.)
- (3) Medical equipment
- (4) Power-generation control equipment
- (5) Atomic energy-related equipment
- (6) Seabed equipment
- (7) Transportation control equipment

- (8) Public information-processing equipment
- (9) Military equipment
- (10) Electric heating apparatus, burning equipment
- (11) Disaster prevention/crime prevention equipment
- (12) Safety equipment
- (13) Other applications that are not considered general-purpose applications

When designing your equipment even for general-purpose applications, you are kindly requested to take into consideration securing protection circuit/device or providing backup circuits in your equipment.

## Looking for pricing, stock, or lifecycle information?

Click below to explore more details on WIN SOURCE:

- ⊖ [View MLG0402Q1N7BT000 on WIN SOURCE](#)
- ⊖ [TDK Corporation](#) Information

## Optimize Your Supply Chain with WIN SOURCE Solutions

- ✓ Global Sourcing Solution
- ✓ Obsolete Management
- ✓ Cost Control Management
- ✓ Shortage Management
- ✓ Alternative Solution
- ✓ Excess Inventory Management