



**THE DATASHEET OF
BD8629FS-E2**



System Power Supply for TV Series

Built-in 1ch FET Synchronous Rectification Type DC/DC converters

**BD8629FS****●Description**

BD8629FS has realized the high performance and reliability required as a power supply for thin-screen TV.

With built-in FET 1ch current mode control, the DC/DC Converter series has the advantage of high-speed load response and wide phase margin.

Due to the high-speed load response, it is most suitable for TV-purpose processors with increasingly high performance, and due to the wide phase margin it leaves a good margin for board pattern & constant setting and so facilitates its application design.

As a high-reliability design, it has various built-in protection circuits (overcurrent protection, output voltage abnormal protection, thermal protection, and off-latch function at the time of abnormality etc.), therefore as an advantage it does not easily damage in every possible abnormal condition such as all-pin short circuit test etc. and hence most suitable for thin-screen TV which requires the high reliability.

●Features

- 1) High efficiency in all load area
- 2) 2.0A output current
- 3) Low RDS(ON) internal switches (PchMOS:170mΩ, NchMOS:130mΩ)
- 4) ±1% reference voltage accuracy
- 5) Programmable frequency : 250kHz-1MHz
- 6) Terminal RT OPEN/SHORT detecting function
- 7) Over current protection function
- 8) Output over voltage/low voltage protection function (over : FB > VREF +60mV , low : FB < VREF -60mV)
- 9) Timer off latch function in abnormal circumstances
- 10) Thermal shutdown function
- 11) Under voltage protection
- 12) Soft start/start delay circuit
- 13) Soft start time out function
- 14) SSOP-A16 package

Aug. 2008

• Electrical characteristic

(Unless otherwise noted Ta=25°C, V_{IN}=5.6V)

Parameter	Symbol	Specification value			UNIT	Condition
		MIN	TYP	MAX		
VIN supply current (operating)	I _{Q_active}	-	1.3	2.0	mA	V _{FB} = 0.83V, V _{FC} = 1V
VIN supply current (standby)	I _{Q_stby}	-	350	700	μA	V _{EN} = 0V
Reference voltage (VREF)	V _{REF}	0.792	0.8	0.808	V	
Output rise detection voltage	V _{OVP}	30	60	90	mV	Monitoring FB terminal
Output decrease detection voltage	V _{LVP}	-90	-60	-30	mV	Monitoring FB terminal
Terminal PDET output current	I _{PDET}	1	-	-	mA	V _{PDET} < 0.5V
Oscillation frequency	f _{OSC}	500	550	600	kHz	R _{OSC} = 220kΩ
Pch FET ON resistance	R _{PFET}	-	170	240	mΩ	I _{SW} = 1A
Nch FET ON resistance	R _{NFET}	-	130	200	mΩ	I _{SW} = -1A
UVLO voltage	V _{UVLO}	3.8	4.0	4.2	V	
SW leak current	I _{LSW}	-	0	1	μA	V _{EN} = 0V, V _{IN} = 6V
EN terminal H threshold voltage	V _{ENH}	2.0	-	-	V	
EN terminal L threshold voltage	V _{ENL}	-	-	0.5	V	
SS/DELAY terminal source current	I _{SSSO}	2	4	6	μA	

V_{FB}:FB terminal voltage, V_{EN}:EN terminal voltage, V_{FC}:FC terminal voltage, V_{PDET}: PDET terminal voltage

Current capability should not exceed Pd.

Permissible loss

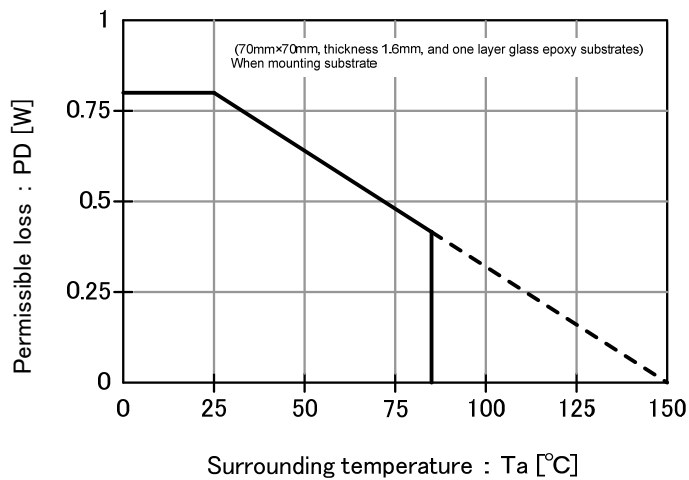

Fig. 1 heat decrease curve

• Block Diagram

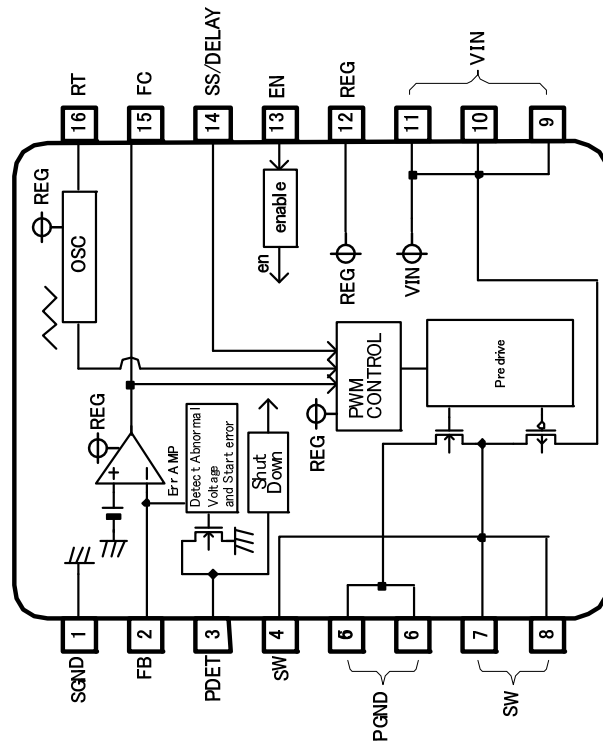

Fig.2 Block diagram

• Pin description

No.	Symbol	Description	Explanation
1	SGND	Signal GND terminal	Small signal system GND
2	FB	Feed back terminal	Output voltage detection
3	PDET	Off latch signal output	Reset output
4	SW	Output terminal	Switching output
5	PGND	Power GND terminal	GND for power MOSFET
6	PGND		
7	SW	Output terminal	Power Mos output
8	SW		
9	VIN	Power supply input terminal	Power supply input. The decoupling is done to PGND
10	VIN		
11	VIN		
12	REG	Internal regulator	Internal regulator
13	EN	Enable input	ON/OFF control for device operation
14	SS/DELAY	Soft start adjustment capacity connection terminal	The soft start time is adjusted with the connected capacitor
15	FC	Error amplifier output	Error amplifier phase compensation point
16	RT	Frequency adjustment resistance connection terminal	The switching frequency is set by the connected resistance

●Pin equivalence circuit diagram

No.	Symbol	Explanation	Terminal equivalent circuit diagram
1	SGND	GND (connected 0V)	
2	FB	Output voltage detection terminal	
3	PDET	Off latch signal output terminal	
4,7,8	SW	Output terminal	
5,6	PGND	Power GND (Same voltage as SGND)	
9,10,11	VIN	Power supply input terminal	

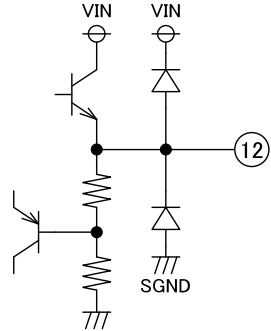
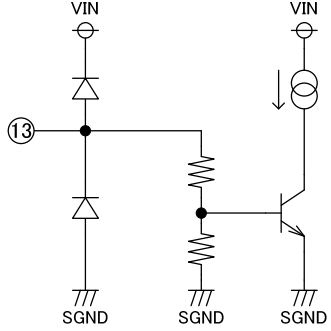
No.	Symbol	Explanation	Terminal equivalent circuit diagram
12	REG	Internal regulator output terminal	 <p>The diagram shows a differential pair of transistors. The top transistor's emitter is connected to a node labeled 12. The bottom transistor's emitter is connected to a node labeled 12. The top transistor's collector is connected to VIN through a diode. The bottom transistor's collector is connected to VIN through a diode. The top transistor's base is connected to a resistor, which is connected to a diode to VIN. The bottom transistor's base is connected to a resistor, which is connected to a diode to SGND. The top transistor's emitter is connected to a resistor, which is connected to a diode to SGND. The bottom transistor's emitter is connected to a resistor, which is connected to a diode to SGND.</p>
13	EN	Enable terminal	 <p>The diagram shows a diode connected to VIN and SGND. The output terminal is labeled 13. A resistor is connected to a diode to SGND. A transistor is connected to a diode to SGND.</p>

No.	Symbol	Explanation	Terminal equivalent circuit diagram
14	SS	Soft start time adjustment terminal	
15	FC	Error amplifier compensation terminal	
16	RT	Oscillator frequency adjustment terminal	

- Operation description

- **Enable control**

- The device can be controlled ON/OFF by EN terminal (13 pin) voltage.

- An internal circuit starts when VEN reaches 1.4V.

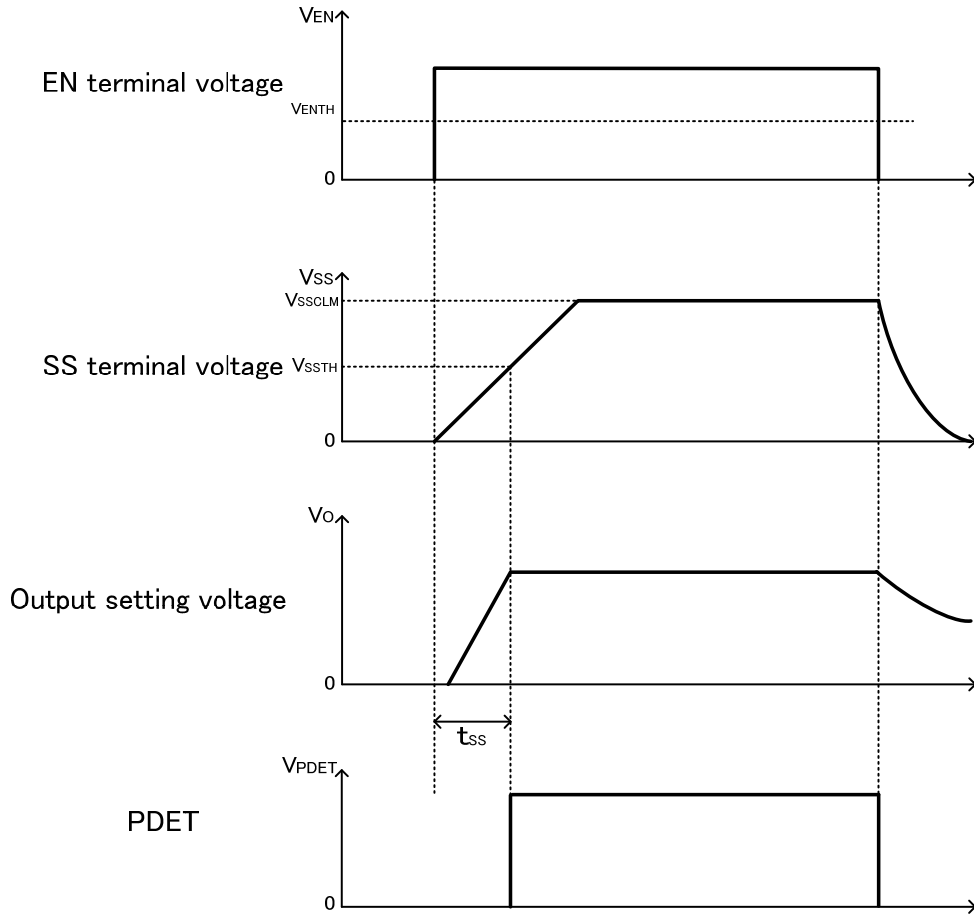

Fig. 3 ON/OFF transition wave form in EN controlling

- **Soft start time set function**

- As for BD8629FS, output can do soft start without overshoot by charging soft start capacity (CSS) connected between SS and SGND terminal.

- Also, soft start time (tss) can be set by setting soft start capacity (CSS) arbitrarily.

OSC oscillation frequency setting function

The output oscillation frequency can be set by connecting resistance between terminal RT (16 pins) and SGND (range = 250kHz - 1MHz)

The relation between RT terminal resistance and the oscillation frequency follows Fig.3.

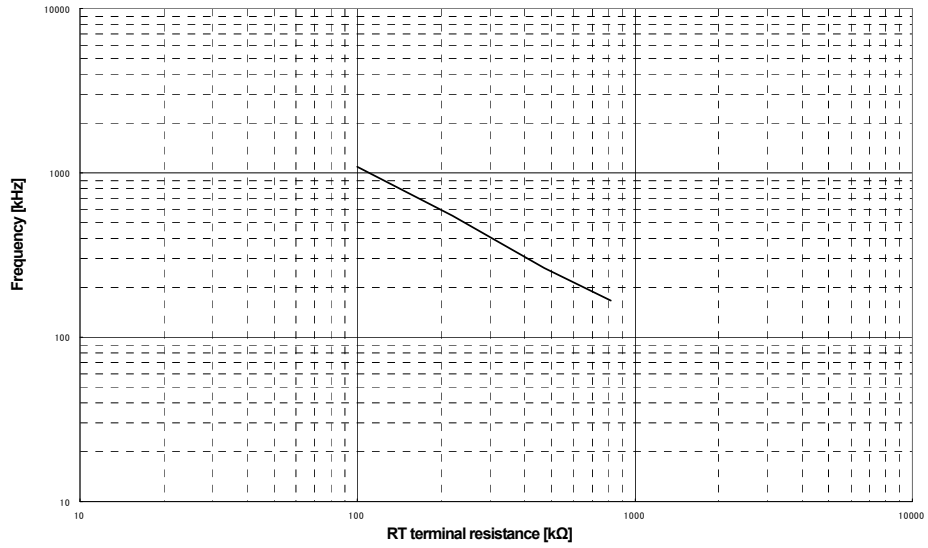

Fig. 4 RT resistance-oscillation frequency

● **Protection function**

Protection circuit is effective for destruction prevention due to accident so that avoid using under continuous protection operation.

Low voltage protection function (LVP)

The voltage of the terminal FB (2 pins) is compared with internal reference voltage VREF.

If FB terminal voltage falls below $V_{LVP}(= VREF - 60mV)$ and the state continues for 500us, output changes to low voltage and the state is fixed. In that case , PDET (3pin) output changes to L.

Table 4-1 output low voltage protection function

EN terminal	SS terminal	FB terminal	Low voltage protection function	Low voltage protection operation
$>V_{IHEN}$	$>1.4V(\text{typ})$	$<V_{LVP}$	Effective	ON
		$>V_{LVP}$		OFF
	$<1.4V(\text{typ})$	-	Invalidity	OFF
$<V_{ILEN}$	-	-	Invalidity	OFF

* Low voltage protection function is available when SS terminal voltage becomes more than 1.4V (typ) in the transition to ON control (during soft start).

Over voltage protection function(OVP)

The voltage of the terminal FB is compared with internal reference voltage VREF.

If FB terminal voltage is over $V_{ovp}(=VREF + 60mV)$ and the state is continues for 500usec, output changes to low voltage and the state is fixed.

Table 4-2 output overvoltage protection function

EN terminal	SS terminal	FB terminal	Over voltage protection function	Over voltage protection operation
$>V_{IHEN}$	$>1.4V(\text{typ})$	$>V_{OVP}$	Effective	ON
		$<V_{OVP}$		OFF
	$<1.4V(\text{typ})$	-	Invalidity	OFF
$<V_{ILEN}$	-	-	Invalidity	OFF

* Over voltage protection function is available when SS terminal voltage becomes more than 1.4V (typ) in the transition to ON control (during soft start).

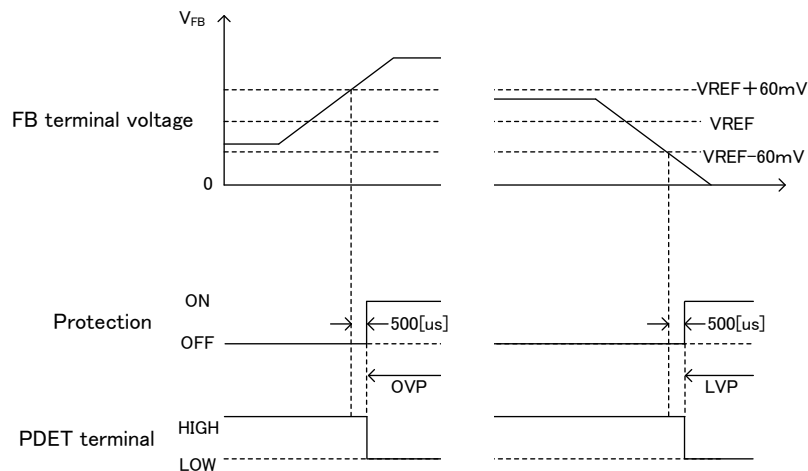

Fig. 5 Output voltage error detection range

Under voltage lock out protection (UVLO)

As for BD8629FS, the power-supply voltage decrease detection protection circuit is built in.

If the input voltage decrease below the UVLO voltage (4.0V typ), the device state changes to the standby mode (Moreover, to prevent the chattering of the output) hysteresis width of 300mV(typ) has been installed in the UVLO cancel voltage.

RT terminal open/short protection function (RTO/RTS)

RT terminal opening/short protection function prevent the clock from abnormal oscillation.

If RT terminal open/short protection function is detected, output voltage changes to low level and is fixed.

Terminal RT opening/short protection function is always effective after the power supply start-up.

Terminal RT opening/short protection function is available if the state continue for 500usec, abnormal detection operates when the state continues about 500μsec(typ).

Soft start time-out function

If VSS doesn't exceed VSSTH within 64msec (typ) since a soft start began, BD8629FS controls an off latch.

Vo is fixed in a low level.

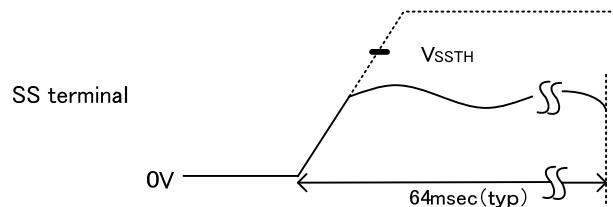

Fig. 6 Soft start time-out

Error detection (off latch) release method

BD8629FS enters the state of an off latch when the protection function operates.

To release the off latch state, EN terminal voltage should be changed to low level once time.

Thermal shut down function

Thermal shut down circuit (TSD circuit) is built into BD8629FS. When the temperature of the chip exceeds $T_{jmax}=175$, the DC/DC converter is fixed in a low voltage.

TSD function is aimed to shut down IC from thermal reckless driving under an abnormal state to exceed $T_{jmax}=175$. It aims at neither protection nor the guarantee of the set. Therefore, please do not use this function to protect the set.

Over current protection function

The over current protection function has been achieved by limiting the current that flows on high side MOSFET.

The current is controlled in every one cycle of the switching frequency. When an abnormal state continues for about 500μsec(typ), the output is fixed in a low level.

SSOP-A16

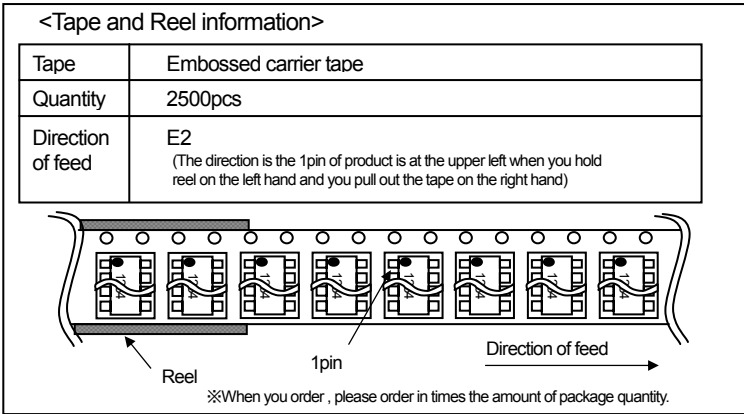
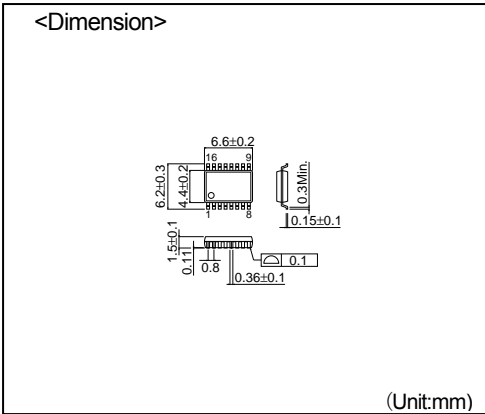

- The contents described herein are correct as of August, 2008
- The contents described herein are subject to change without notice. For updates of the latest information, please contact and confirm with ROHM CO.,LTD.
- Any part of this application note must not be duplicated or copied without our permission.
- Application circuit diagrams and circuit constants contained herein are shown as examples of standard use and operation. Please pay careful attention to the peripheral conditions when designing circuits and deciding upon circuit constants in the set.
- Any data, including, but not limited to application circuit diagrams and information, described herein are intended only as illustrations of such devices and not as the specifications for such devices. ROHM CO.,LTD. disclaims any warranty that any use of such devices shall be free from infringement of any third party's intellectual property rights or other proprietary rights, and further, assumes no liability of whatsoever nature in the event of any such infringement, or arising from or connected with or related to the use of such devices.
- Upon the sale of any such devices, other than for buyer's right to use such devices itself, resell or otherwise dispose of the same, implied right or license to practice or commercially exploit any intellectual property rights or other proprietary rights owned or controlled by ROHM CO., LTD. is granted to any such buyer.
- The products described herein utilize silicon as the main material.
- The products described herein are not designed to be X ray proof.

The products listed in this catalog are designed to be used with ordinary electronic equipment or devices (such as audio visual equipment, office-automation equipment, communications devices, electrical appliances and electronic toys). Should you intend to use these products with equipment or devices which require an extremely high level of reliability and the malfunction of which would directly endanger human life (such as medical instruments, transportation equipment, aerospace machinery, nuclear-reactor controllers, fuel controllers and other safety devices), please be sure to consult with our sales representative in advance.

Contact us for further information about the products.

San Diego	TEL: +1-858-625-3630	FAX: +1-858-625-3670	Tianjin	TEL: +86-22-23029181	FAX: +86-22-23029183
Atlanta	TEL: +1-770-754-5972	FAX: +1-770-754-0691	Shanghai	TEL: +86-21-6279-2727	FAX: +86-21-6247-2066
Boston	TEL: +1-978-371-0382	FAX: +1-928-438-7164	Hangzhou	TEL: +86-571-87658072	FAX: +86-571-87658071
Chicago	TEL: +1-847-368-1006	FAX: +1-847-368-1008	Nanjing	TEL: +86-25-8689-0015	FAX: +86-25-8689-0393
Dallas	TEL: +1-469-287-5366	FAX: +1-469-362-7973	Ningbo	TEL: +86-574-87654201	FAX: +86-574-87654208
Denver	TEL: +1-303-708-0908	FAX: +1-303-708-0858	Qingdao	TEL: +86-532-5779-312	FAX: +86-532-5779-653
Detroit	TEL: +1-248-348-9920	FAX: +1-248-348-9942	Suzhou	TEL: +86-510-82702693	FAX: +86-510-82702992
Nashville	TEL: +1-615-620-6700	FAX: +1-615-620-6702	Wuxi	TEL: +86-510-82702693	FAX: +86-510-82702992
Mexico	TEL: +52-33-3123-2001	FAX: +52-33-3123-2002	Shenzhen	TEL: +86-755-8307-3008	FAX: +86-755-8307-3003
Düsseldorf	TEL: +49-2154-9210	FAX: +49-2154-921400	Dongguan	TEL: +86-769-8393-3320	FAX: +86-769-8398-4140
Munich	TEL: +49-8999-216168	FAX: +49-8999-216176	Fuzhou	TEL: +86-591-8801-8698	FAX: +86-591-8801-8690
Stuttgart	TEL: +49-711-7272-370	FAX: +49-711-7272-3720	Guangzhou	TEL: +86-20-3878-8100	FAX: +86-20-3825-5965
France	TEL: +33-1-5697-3060	FAX: +33-1-5697-3080	Huizhou	TEL: +86-752-205-1054	FAX: +86-752-205-1059
United Kingdom	TEL: +44-1-908-306700	FAX: +44-1-908-235788	Xiamen	TEL: +86-592-238-5705	FAX: +86-592-239-8380
Denmark	TEL: +45-3694-4739	FAX: +45-3694-4789	Zhuhai	TEL: +86-756-3232-480	FAX: +86-756-3232-460
Espoo	TEL: +358-9725-54491	FAX: +358-9-7255-4499	Hong Kong	TEL: +852-2-740-6262	FAX: +852-2-375-8971
Salò	TEL: +358-2-7332234	FAX: +358-2-7332237	Taipei	TEL: +886-2-2500-6956	FAX: +886-2-2503-2869
Oulu	TEL: +358-8-5372930	FAX: +358-8-5372931	Kaohsiung	TEL: +886-7-237-0881	FAX: +886-7-238-7332
Barcelona	TEL: +34-9375-24320	FAX: +34-9375-24410	Singapore	TEL: +65-6332-2322	FAX: +65-6332-5662
Hungary	TEL: +36-1-4719338	FAX: +36-1-4719339	Philippines	TEL: +63-2-807-6872	FAX: +63-2-809-1422
Poland	TEL: +48-22-5757213	FAX: +48-22-5757001	Thailand	TEL: +66-2-254-4890	FAX: +66-2-256-6334
Russia	TEL: +7-495-739-41-74	FAX: +7-495-739-41-74	Kuala Lumpur	TEL: +60-3-7958-8355	FAX: +60-3-7958-8377
Seoul	TEL: +82-2-8182-700	FAX: +82-2-8182-715	Penang	TEL: +60-4-2286453	FAX: +60-4-2286452
Masan	TEL: +82-55-240-6234	FAX: +82-55-240-6236	Kyoto	TEL: +81-75-365-1218	FAX: +81-75-365-1228
Dalian	TEL: +86-411-8230-8549	FAX: +86-411-8230-8537	Yokohama	TEL: +81-45-476-2290	FAX: +81-45-476-2295
Beijing	TEL: +86-10-8525-2483	FAX: +86-10-8525-2489			

Excellence in Electronics



ROHM CO., LTD.

21 Saiin Mizosaki-cho, Ukyo-ku, Kyoto
615-8585, Japan
TEL: +81-75-311-2121 FAX: +81-75-315-0172
URL: <http://www.rohm.com>

Published by
KTC LSI Development Headquarters
LSI Business Promotion Group

Notes

- No technical content pages of this document may be reproduced in any form or transmitted by any means without prior permission of ROHM CO.,LTD.
- The contents described herein are subject to change without notice. The specifications for the product described in this document are for reference only. Upon actual use, therefore, please request that specifications to be separately delivered.
- Application circuit diagrams and circuit constants contained herein are shown as examples of standard use and operation. Please pay careful attention to the peripheral conditions when designing circuits and deciding upon circuit constants in the set.
- Any data, including, but not limited to application circuit diagrams information, described herein are intended only as illustrations of such devices and not as the specifications for such devices. ROHM CO.,LTD. disclaims any warranty that any use of such devices shall be free from infringement of any third party's intellectual property rights or other proprietary rights, and further, assumes no liability of whatsoever nature in the event of any such infringement, or arising from or connected with or related to the use of such devices.
- Upon the sale of any such devices, other than for buyer's right to use such devices itself, resell or otherwise dispose of the same, no express or implied right or license to practice or commercially exploit any intellectual property rights or other proprietary rights owned or controlled by
- ROHM CO., LTD. is granted to any such buyer.
- Products listed in this document are no antiradiation design.

The products listed in this document are designed to be used with ordinary electronic equipment or devices (such as audio visual equipment, office-automation equipment, communications devices, electrical appliances and electronic toys).

Should you intend to use these products with equipment or devices which require an extremely high level of reliability and the malfunction of which would directly endanger human life (such as medical instruments, transportation equipment, aerospace machinery, nuclear-reactor controllers, fuel controllers and other safety devices), please be sure to consult with our sales representative in advance.

It is our top priority to supply products with the utmost quality and reliability. However, there is always a chance of failure due to unexpected factors. Therefore, please take into account the derating characteristics and allow for sufficient safety features, such as extra margin, anti-flammability, and fail-safe measures when designing in order to prevent possible accidents that may result in bodily harm or fire caused by component failure. ROHM cannot be held responsible for any damages arising from the use of the products under conditions out of the range of the specifications or due to non-compliance with the NOTES specified in this catalog.

Thank you for your accessing to ROHM product informations.

More detail product informations and catalogs are available, please contact your nearest sales office.

ROHM Customer Support System



THE AMERICAS / EUROPE / ASIA / JAPAN

www.rohm.com







Contact us : webmaster@rohm.co.jp

Looking for pricing, stock, or lifecycle information?

Click below to explore more details on WIN SOURCE:

-  [View BD8629FS-E2 on WIN SOURCE](#)
-  [Rohm Semiconductor](#) Information

Optimize Your Supply Chain with WIN SOURCE Solutions

-  Global Sourcing Solution
-  Obsolete Management
-  Cost Control Management
-  Shortage Management
-  Alternative Solution
-  Excess Inventory Management