



**THE DATASHEET OF
LM4041DQDBZT**



FEATURES

- 1.225-V Fixed and Adjustable Outputs (1.225 V to 10 V)
- Tight Output Tolerances and Low Temperature Coefficient
 - Max 0.1%, 100 ppm/°C – A Grade
 - Max 0.2%, 100 ppm/°C – B Grade
 - Max 0.5%, 100 ppm/°C – C Grade
 - Max 1.0%, 150 ppm/°C – D Grade
- Low Output Noise . . . 20 μV_{RMS} (Typ)
- Wide Operating Current Range . . . 45 μA (Typ) to 12 mA
- Stable With All Capacitive Loads; No Output Capacitor Required
- Available in
 - Industrial Temperature: –40°C to 85°C
 - Extended Temperature: –40°C to 125°C

- Applications
 - Data-Acquisition Systems
 - Power Supplies and Power-Supply Monitors
 - Instrumentation and Test Equipment
 - Process Control
 - Precision Audio
 - Automotive Electronics
 - Energy Management/Metering
 - Battery-Powered Equipment

1.2 V . . . DBZ (SOT-23) PACKAGE
(TOP VIEW)



* Pin 3 must be connected to ANODE or left open.

1.2 V . . . DCK (SC-70) PACKAGE
(TOP VIEW)

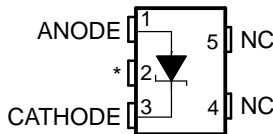

NC – No internal connection
* Pin 2 must be connected to ANODE or left open.

1.2 V . . . LP (TO-92/TO-226) PACKAGE
(TOP VIEW)

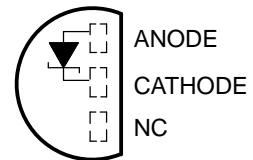

NC – No internal connection

Adjustable . . . DBZ (SOT-23) PACKAGE
(TOP VIEW)



Adjustable . . . DCK (SC-70) PACKAGE
(TOP VIEW)

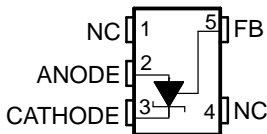

NC – No internal connection

Adjustable . . . LP (TO-92/TO-226) PACKAGE
(TOP VIEW)

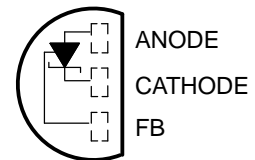

DESCRIPTION/ORDERING INFORMATION

The LM4041 series of shunt voltage references are versatile, easy-to-use references suitable for a wide array of applications. They require no external capacitors for operation and are stable with all capacitive loads. Additionally, the reference offers low dynamic impedance, low noise, and a low temperature coefficient to ensure a stable output voltage over a wide range of operating currents and temperatures. The LM4041 uses fuse and Zener-zap reverse breakdown voltage trim during wafer sort to offer four output voltage tolerances, ranging from 0.1% (max) for the A grade to 1% (max) for the D grade. Thus, a great deal of flexibility is offered to designers in choosing the best cost-to-performance ratio for their applications. The LM4041 is available in a fixed (1.225 V nominal) or an adjustable version (which requires an external resistor divider to set the output to a value between 1.225 V and 10 V).



Please be aware that an important notice concerning availability, standard warranty, and use in critical applications of Texas Instruments semiconductor products and disclaimers thereto appears at the end of this data sheet.

LM4041

PRECISION MICROPOWER SHUNT VOLTAGE REFERENCE

SLCS146E—FEBRUARY 2005—REVISED FEBRUARY 2006

Packaged in space-saving SC-70 and SOT-23-3 and requiring a minimum current of 45 μ A (typ), the LM4041 also is ideal for portable applications. The TO-92 package also is available for through-hole packaging needs. The LM4041xl is characterized for operation over an ambient temperature range of -40°C to 85°C . The LM4041xQ is characterized for operation over an ambient temperature range of -40°C to 125°C .

ORDERING INFORMATION

T _A	DEVICE GRADE	V _Z	PACKAGE ⁽¹⁾		ORDERABLE PART NUMBER	TOP-SIDE MARKING ⁽²⁾
-40°C to 85°C	A grade: 0.1% initial accuracy and 100 ppm/ $^{\circ}\text{C}$ temperature coefficient	1.2 V	SC-70 (DCK)	Reel of 3000	LM4041A12IDCKR	MK_
				Reel of 250	LM4041A12IDBZR	4MK_
			SOT-23-3 (DBZ)	Bulk of 1000	LM4041A12ILP	PREVIEW
				Reel of 2000	LM4041A12ILPR	
			TO-92/TO-226 (LP)	Reel of 3000	LM4041B1DCKR	MG_
				Reel of 250	LM4041B1DCKT	
	B grade: 0.2% initial accuracy and 100 ppm/ $^{\circ}\text{C}$ temperature coefficient	ADJ	SC-70 (DCK)	Reel of 3000	LM4041B1DBZR	4MG_
				Reel of 250	LM4041B1DBZT	
			SOT-23-3 (DBZ)	Bulk of 1000	LM4041B1ILP	PREVIEW
				Reel of 2000	LM4041B1ILPR	
			TO-92/TO-226 (LP)	Reel of 3000	LM4041B12IDCKR	ML_
				Reel of 250	LM4041B12IDBZR	
	C grade: 0.5% initial accuracy and 100 ppm/ $^{\circ}\text{C}$ temperature coefficient	1.2 V	SC-70 (DCK)	Reel of 3000	LM4041B12IDBZT	4ML_
				Reel of 250	LM4041B12IDBZT	
			SOT-23-3 (DBZ)	Bulk of 1000	LM4041B12ILP	PREVIEW
				Reel of 2000	LM4041B12ILPR	
			TO-92/TO-226 (LP)	Reel of 3000	LM4041C1DCKR	MH_
				Reel of 250	LM4041C1DCKT	
	D grade: 1.0% initial accuracy and 150 ppm/ $^{\circ}\text{C}$ temperature coefficient	ADJ	SC-70 (DCK)	Reel of 3000	LM4041C1DBZR	4MH_
				Reel of 250	LM4041C1DBZT	
			SOT-23-3 (DBZ)	Bulk of 1000	LM4041C1ILP	PREVIEW
				Reel of 2000	LM4041C1ILPR	
			TO-92/TO-226 (LP)	Reel of 3000	LM4041C12IDCKR	MM_
				Reel of 250	LM4041C12IDBZR	
-40°C to 85°C	1.2 V	SC-70 (DCK)	Reel of 3000	LM4041C12IDBZT	4MM_	
			Reel of 250	LM4041C12IDBZT		
		SOT-23-3 (DBZ)	Bulk of 1000	LM4041C12ILP	PREVIEW	
			Reel of 2000	LM4041C12ILPR		
		TO-92/TO-226 (LP)	Reel of 3000	LM4041D1DCKR	MJ_	
			Reel of 250	LM4041D1DCKT		
	D grade: 1.0% initial accuracy and 150 ppm/ $^{\circ}\text{C}$ temperature coefficient	ADJ	SC-70 (DCK)	Reel of 3000	LM4041D1DBZR	4MJ_
				Reel of 250	LM4041D1DBZT	
			SOT-23-3 (DBZ)	Bulk of 1000	LM4041D1ILP	PREVIEW
				Reel of 2000	LM4041D1ILPR	
			TO-92/TO-226 (LP)	Reel of 3000	LM4041D12IDCKR	MN_
				Reel of 250	LM4041D12IDBZR	
D grade: 1.0% initial accuracy and 150 ppm/ $^{\circ}\text{C}$ temperature coefficient	1.2 V	SC-70 (DCK)	Reel of 3000	LM4041D12IDBZT	4MN_	
			Reel of 250	LM4041D12IDBZT		
		SOT-23-3 (DBZ)	Bulk of 1000	LM4041D12ILP	PREVIEW	
			Reel of 2000	LM4041D12ILPR		
		TO-92/TO-226 (LP)	Reel of 3000	LM4041D12IDCKR	MN_	
			Reel of 250	LM4041D12IDBZR		

(1) Package drawings, standard packing quantities, thermal data, symbolization, and PCB design guidelines are available at www.ti.com/sc/package.

(2) DBZ/DCK: The actual top-side marking has one additional character that designates the assembly/test site.

ORDERING INFORMATION

T _A	DEVICE GRADE	V _Z	PACKAGE ⁽¹⁾		ORDERABLE PART NUMBER	TOP-SIDE MARKING ⁽²⁾
–40°C to 125°C	C grade: 0.5% initial accuracy and 100 ppm/°C temperature coefficient	ADJ	SOT-23-3 (DBZ)	Reel of 3000	LM4041CQDBZR	4MP_
				Reel of 250	LM4041CQDBZT	
		1.2 V	SOT-23-3 (DBZ)	Reel of 3000	LM4041C12QDBZR	4MS_
				Reel of 250	LM4041C12QDBZT	
	D grade: 1.0% initial accuracy and 150 ppm/°C temperature coefficient	ADJ	SOT-23-3 (DBZ)	Reel of 3000	LM4041DQDBZR	4MR_
				Reel of 250	LM4041DQDBZT	
		1.2 V	SOT-23-3 (DBZ)	Reel of 3000	LM4041D12QDBZR	4MT_
				Reel of 250	LM4041D12QDBZT	

(1) Package drawings, standard packing quantities, thermal data, symbolization, and PCB design guidelines are available at www.ti.com/sc/package.

(2) DBZ/DCK: The actual top-side marking has one additional character that designates the assembly/test site.

LM4041 PRECISION MICROPOWER SHUNT VOLTAGE REFERENCE

SLCS146E—FEBRUARY 2005—REVISED FEBRUARY 2006

FUNCTIONAL BLOCK DIAGRAM



- (1) LM4041x (ADJ) only
(2) LM4041x12 only

Absolute Maximum Ratings⁽¹⁾

over free-air temperature range (unless otherwise noted)

		MIN	MAX	UNIT
V_Z	Continuous cathode voltage		15	V
I_Z	Continuous cathode current	-10	25	mA
θ_{JA}	Package thermal impedance ⁽²⁾⁽³⁾	DBZ package	206	°C/W
		DCK package	252	
		LP package	156	
T_J	Operating virtual junction temperature		150	°C
T_{stg}	Storage temperature range	-65	150	°C

- (1) Stresses beyond those listed under "absolute maximum ratings" may cause permanent damage to the device. These are stress ratings only, and functional operation of the device at these or any other conditions beyond those indicated under "recommended operating conditions" is not implied. Exposure to absolute-maximum-rated conditions for extended periods may affect device reliability.
(2) Maximum power dissipation is a function of $T_J(\text{max})$, θ_{JA} , and T_A . The maximum allowable power dissipation at any allowable ambient temperature is $P_D = (T_J(\text{max}) - T_A)/\theta_{JA}$. Operating at the absolute maximum T_J of 150°C can affect reliability.
(3) The package thermal impedance is calculated in accordance with JESD 51-7.

Recommended Operating Conditions

		MIN	MAX	UNIT
I_Z	Cathode current	(1)	12	mA
V_Z	Reverse breakdown voltage (adjustable version)		10	V
T_A	Free-air temperature	LM4041 (I temperature)	-40	°C
		LM4041 (Q temperature)	-40	

- (1) See parametric tables

LM4041x12I Electrical Characteristics

 full-range $T_A = -40^{\circ}\text{C}$ to 85°C (unless otherwise noted)

PARAMETER	TEST CONDITIONS	T_A	LM4041A12I			LM4041B12I			UNIT	
			MIN	TYP	MAX	MIN	TYP	MAX		
V_Z	Reverse breakdown voltage	$I_Z = 100\ \mu\text{A}$	25°C			1.225			V	
	Reverse breakdown voltage tolerance	$I_Z = 100\ \mu\text{A}$	25°C			1.225			mV	
			Full range			-1.2	1.2	-2.4		2.4
$I_{Z,\text{min}}$	Minimum cathode current		25°C			1.225			μA	
			Full range			-9.2	9.2	-10.4		10.4
α_{VZ}	Average temperature coefficient of reverse breakdown voltage	$I_Z = 10\ \text{mA}$	25°C			±20			ppm/°C	
		$I_Z = 1\ \text{mA}$	25°C			±15				
			Full range			±100				
		$I_Z = 100\ \mu\text{A}$	25°C			±15				
$\Delta V_Z/\Delta I_Z$	Reverse breakdown voltage change with cathode current change	$I_{Z,\text{min}} < I_Z < 1\ \text{mA}$	25°C			0.7	1.5	0.7	1.5	mV
			Full range			2				
		$1\ \text{mA} < I_Z < 12\ \text{mA}$	25°C			4	6	4	6	
			Full range			8				
Z_Z	Reverse dynamic impedance	$I_Z = 1\ \text{mA}$, $f = 120\ \text{Hz}$, $I_{AC} = 0.1 I_Z$	25°C			0.5	1.5	0.5	1.5	Ω
e_N	Wideband noise	$I_Z = 100\ \mu\text{A}$, $10\ \text{Hz} \leq f \leq 10\ \text{kHz}$	25°C			20			μV_{RMS}	
	Long-term stability of reverse breakdown voltage	$t = 1000\ \text{h}$, $T_A = 25^{\circ}\text{C} \pm 0.1^{\circ}\text{C}$, $I_Z = 100\ \mu\text{A}$	25°C			120			ppm	

LM4041 PRECISION MICROPOWER SHUNT VOLTAGE REFERENCE

SLCS146E—FEBRUARY 2005—REVISED FEBRUARY 2006

LM4041x12I Electrical Characteristics

full-range $T_A = -40^\circ\text{C}$ to 85°C (unless otherwise noted)

PARAMETER	TEST CONDITIONS	T_A	LM4041C12I			LM4041D12I			UNIT
			MIN	TYP	MAX	MIN	TYP	MAX	
V_Z	Reverse breakdown voltage	$I_Z = 100\ \mu\text{A}$	1.225			1.225			V
	Reverse breakdown voltage tolerance	$I_Z = 100\ \mu\text{A}$	25°C		-6	6	-12	12	mV
			Full range		-14	14	-24	24	
$I_{Z,\text{min}}$	Minimum cathode current		25°C		45	75	45	75	μA
			Full range		80				
α_{VZ}	Average temperature coefficient of reverse breakdown voltage	$I_Z = 10\ \text{mA}$	25°C		± 20		± 20		ppm/°C
		$I_Z = 1\ \text{mA}$	25°C		± 15		± 15		
			Full range		± 100		± 150		
		$I_Z = 100\ \mu\text{A}$	25°C		± 15		± 15		
$\Delta V_Z/\Delta I_Z$	Reverse breakdown voltage change with cathode current change	$I_{Z,\text{min}} < I_Z < 1\ \text{mA}$	25°C		0.7	1.5	0.7	2	mV
			Full range		2		2.5		
		$1\ \text{mA} < I_Z < 12\ \text{mA}$	25°C		2.5	6	2.5	8	
			Full range		8		10		
Z_Z	Reverse dynamic impedance	$I_Z = 1\ \text{mA}$, $f = 120\ \text{Hz}$, $I_{AC} = 0.1\ I_Z$	25°C		0.5	1.5	0.5	2	Ω
e_N	Wideband noise	$I_Z = 100\ \mu\text{A}$, $10\ \text{Hz} \leq f \leq 10\ \text{kHz}$	25°C		20		20		μV_{RMS}
	Long-term stability of reverse breakdown voltage	$t = 1000\ \text{h}$, $T_A = 25^\circ\text{C} \pm 0.1^\circ\text{C}$, $I_Z = 100\ \mu\text{A}$	25°C		120		120		ppm

LM4041x12Q Electrical Characteristics

full-range $T_A = -40^\circ\text{C}$ to 125°C (unless otherwise noted)

PARAMETER	TEST CONDITIONS	T_A	LM4041C12Q			LM4041D12Q			UNIT	
			MIN	TYP	MAX	MIN	TYP	MAX		
V_Z	Reverse breakdown voltage	$I_Z = 100\ \mu\text{A}$	1.225			1.225			V	
	Reverse breakdown voltage tolerance	25°C	-6		6	-12		12	mV	
		Full range	-18.4		18.4	-31		31		
$I_{Z,\text{min}}$	Minimum cathode current	25°C		45	75		45	75	μA	
		Full range			80			80		
α_{VZ}	Average temperature coefficient of reverse breakdown voltage	$I_Z = 10\ \text{mA}$	± 20			± 20			ppm/ $^\circ\text{C}$	
		$I_Z = 1\ \text{mA}$	25°C	± 15			± 15			
			Full range		± 100			± 150		
		$I_Z = 100\ \mu\text{A}$	25°C	± 15			± 15			
$\Delta V_Z/\Delta I_Z$	Reverse breakdown voltage change with cathode current change	$I_{Z,\text{min}} < I_Z < 1\ \text{mA}$	25°C	0.7	1.5	0.7		2	mV	
			Full range		2			2.5		
		$1\ \text{mA} < I_Z < 12\ \text{mA}$	25°C		2.5	6	2.5			8
			Full range		8			10		
Z_Z	Reverse dynamic impedance	$I_Z = 1\ \text{mA}$, $f = 120\ \text{Hz}$, $I_{AC} = 0.1 I_Z$	25°C	0.5			0.5			Ω
			Full range		1.5			2		
e_N	Wideband noise	$I_Z = 100\ \mu\text{A}$, $10\ \text{Hz} \leq f \leq 10\ \text{kHz}$	20			20			μV_{RMS}	
	Long-term stability of reverse breakdown voltage	$t = 1000\ \text{h}$, $T_A = 25^\circ\text{C} \pm 0.1^\circ\text{C}$, $I_Z = 100\ \mu\text{A}$	120			120			ppm	

LM4041 PRECISION MICROPOWER SHUNT VOLTAGE REFERENCE

SLCS146E—FEBRUARY 2005—REVISED FEBRUARY 2006

LM4041xl (Adjustable Version) Electrical Characteristics

full-range $T_A = -40^\circ\text{C}$ to 85°C (unless otherwise noted)

PARAMETER	TEST CONDITIONS	T_A	LM4041BI			LM4041CI			UNIT
			MIN	TYP	MAX	MIN	TYP	MAX	
V_{REF}	Reference voltage	$I_Z = 100\ \mu\text{A}$, $V_Z = 5\ \text{V}$	25°C			1.233			V
	Reference voltage tolerance ⁽¹⁾	$I_Z = 100\ \mu\text{A}$, $V_Z = 5\ \text{V}$	25°C			-2.5 2.5			mV
			Full range			-10.5 10.5			
$I_{Z,min}$	Minimum cathode current		25°C			45 75			μA
			Full range			80 80			
$\Delta V_{REF}/\Delta I_Z$	Reference voltage change with cathode current change	$I_{Z,min} < I_Z < 1\ \text{mA}$	25°C			0.7 1.5			mV
			Full range			2 2			
		$1\ \text{mA} < I_Z < 12\ \text{mA}$	25°C			2 4			
			Full range			6 6			
$\Delta V_{REF}/\Delta V_{KA}$	Reference voltage change with output voltage change	$I_Z = 1\ \text{mA}$	25°C			-1.55 -2			mV/V
			Full range			-2.5 -2.5			
I_{FB}	Feedback current		25°C			60 100			nA
			Full range			120 120			
αV_{REF}	Average temperature coefficient of reference voltage ⁽¹⁾	$I_Z = 10\ \text{mA}$, $V_Z = 5\ \text{V}$	25°C			± 20			ppm/°C
		$I_Z = 1\ \text{mA}$, $V_Z = 5\ \text{V}$	25°C			± 15			
			Full range			± 100			
		$I_Z = 100\ \mu\text{A}$, $V_Z = 5\ \text{V}$	25°C			± 15			
Z_Z	Reverse dynamic impedance	$I_Z = 1\ \text{mA}$, $f = 120\ \text{Hz}$, $I_{AC} = 0.1\ I_Z$, $V_Z = V_{REF}$	25°C			0.3			Ω
		$I_Z = 1\ \text{mA}$, $f = 120\ \text{Hz}$, $I_{AC} = 0.1\ I_Z$, $V_Z = 10\ \text{V}$	25°C			2			
e_N	Wideband noise	$I_Z = 100\ \mu\text{A}$, $V_Z = V_{REF}$, $10\ \text{Hz} \leq f \leq 10\ \text{kHz}$	25°C			20			μV_{RMS}
	Long-term stability of reverse breakdown voltage	$t = 1000\ \text{h}$, $T_A = 25^\circ\text{C} \pm 0.1^\circ\text{C}$, $I_Z = 100\ \mu\text{A}$	25°C			120			ppm

(1) Reference voltage tolerance and average temperature coefficient change with output voltage (V_Z). See *Typical Characteristics*.

LM4041xl (Adjustable Version) Electrical Characteristics

full-range $T_A = -40^\circ\text{C}$ to 85°C (unless otherwise noted)

PARAMETER	TEST CONDITIONS	T_A	LM4041DI			UNIT
			MIN	TYP	MAX	
V_{REF}	Reference voltage	$I_Z = 100\ \mu\text{A}$, $V_Z = 5\ \text{V}$	25°C	1.233		V
	Reference voltage tolerance ⁽¹⁾	$I_Z = 100\ \mu\text{A}$, $V_Z = 5\ \text{V}$	25°C	-12	12	mV
			Full range	-24	24	
$I_{Z,min}$	Minimum cathode current		25°C	45	75	μA
			Full range		80	
$\Delta V_{REF}/\Delta I_Z$	Reference voltage change with cathode current change	$I_{Z,min} < I_Z < 1\ \text{mA}$	25°C	0.7	2	mV
			Full range		2.5	
		$1\ \text{mA} < I_Z < 12\ \text{mA}$	25°C	2	6	
			Full range		8	
$\Delta V_{REF}/\Delta V_{KA}$	Reference voltage change with output voltage change	$I_Z = 1\ \text{mA}$	25°C	-1.55	-2	mV/V
			Full range		-3	
I_{FB}	Feedback current		25°C	60	150	nA
			Full range		200	
αV_{REF}	Average temperature coefficient of reference voltage ⁽¹⁾		$I_Z = 10\ \text{mA}$, $V_Z = 5\ \text{V}$	25°C	± 20	ppm/°C
			$I_Z = 1\ \text{mA}$, $V_Z = 5\ \text{V}$	25°C	± 15	
			Full range		± 150	
			$I_Z = 100\ \mu\text{A}$, $V_Z = 5\ \text{V}$	25°C	± 15	
Z_Z	Reverse dynamic impedance		$I_Z = 1\ \text{mA}$, $f = 120\ \text{Hz}$, $I_{AC} = 0.1\ I_Z$, $V_Z = V_{REF}$	25°C	0.3	Ω
			$I_Z = 1\ \text{mA}$, $f = 120\ \text{Hz}$, $I_{AC} = 0.1\ I_Z$, $V_Z = 10\ \text{V}$	25°C	2	
e_N	Wideband noise	$I_Z = 100\ \mu\text{A}$, $V_Z = V_{REF}$, $10\ \text{Hz} \leq f \leq 10\ \text{kHz}$	25°C	20		μV_{RMS}
	Long-term stability of reverse breakdown voltage	$t = 1000\ \text{h}$, $T_A = 25^\circ\text{C} \pm 0.1^\circ\text{C}$, $I_Z = 100\ \mu\text{A}$	25°C	120		ppm

(1) Reference voltage tolerance and average temperature coefficient change with output voltage (V_Z). See *Typical Characteristics*.

LM4041

PRECISION MICROPOWER SHUNT VOLTAGE REFERENCE

SLCS146E—FEBRUARY 2005—REVISED FEBRUARY 2006

LM4041xQ (Adjustable Version) Electrical Characteristics

full-range $T_A = -40^\circ\text{C}$ to 125°C (unless otherwise noted)

PARAMETER	TEST CONDITIONS	T_A	LM4041CQ			LM4041DQ			UNIT
			MIN	TYP	MAX	MIN	TYP	MAX	
V_{REF}	Reference voltage	$I_Z = 100\ \mu\text{A}$, $V_Z = 5\ \text{V}$	25°C			1.233			V
	Reference voltage tolerance ⁽¹⁾	$I_Z = 100\ \mu\text{A}$, $V_Z = 5\ \text{V}$	25°C			-6.2 6.2			mV
			Full range			-18 18			
$I_{Z,min}$	Minimum cathode current		25°C			45 75			μA
			Full range			80 80			
$\Delta V_{REF}/\Delta I_Z$	Reference voltage change with cathode current change	$I_{Z,min} < I_Z < 1\ \text{mA}$	25°C			0.7 1.5			mV
			Full range			2 2.5			
		$1\ \text{mA} < I_Z < 12\ \text{mA}$	25°C			2 4			
			Full range			8 10			
$\Delta V_{REF}/\Delta V_{KA}$	Reference voltage change with output voltage change	$I_Z = 1\ \text{mA}$	25°C			-1.55 -2			mV/V
			Full range			-3 -4			
I_{FB}	Feedback current		25°C			60 100			nA
			Full range			120 200			
αV_{REF}	Average temperature coefficient of reference voltage ⁽¹⁾	$I_Z = 10\ \text{mA}$, $V_Z = 5\ \text{V}$	25°C			± 20			ppm/°C
			25°C			± 15			
		$I_Z = 1\ \text{mA}$, $V_Z = 5\ \text{V}$	Full range			± 100			
			25°C			± 15			
Z_Z	Reverse dynamic impedance	$I_Z = 1\ \text{mA}$, $f = 120\ \text{Hz}$, $I_{AC} = 0.1\ I_Z$, $V_Z = V_{REF}$	25°C			0.3			Ω
			25°C			2			
e_N	Wideband noise	$I_Z = 100\ \mu\text{A}$, $V_Z = V_{REF}$, $10\ \text{Hz} \leq f \leq 10\ \text{kHz}$	25°C			20			μV_{RMS}
	Long-term stability of reverse breakdown voltage	$t = 1000\ \text{h}$, $T_A = 25^\circ\text{C} \pm 0.1^\circ\text{C}$, $I_Z = 100\ \mu\text{A}$	25°C			120			ppm

(1) Reference voltage tolerance and average temperature coefficient change with output voltage (V_Z). See *Typical Characteristics*.

TYPICAL CHARACTERISTICS

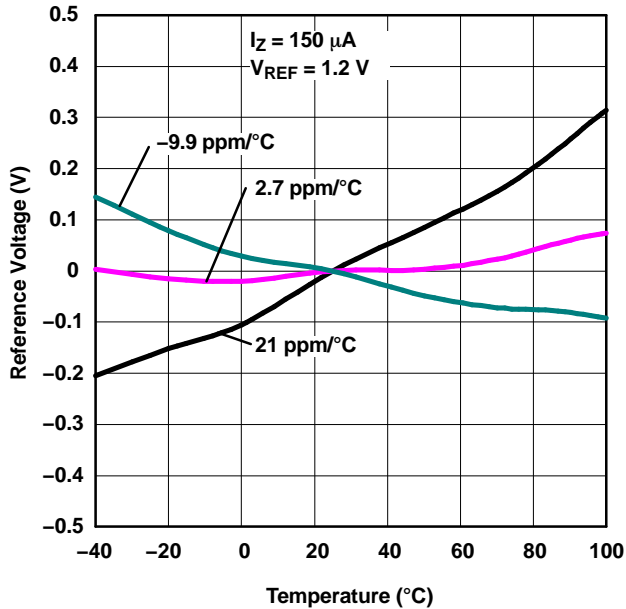

Figure 1. Temperature Drift for Different Average Temperature Coefficients

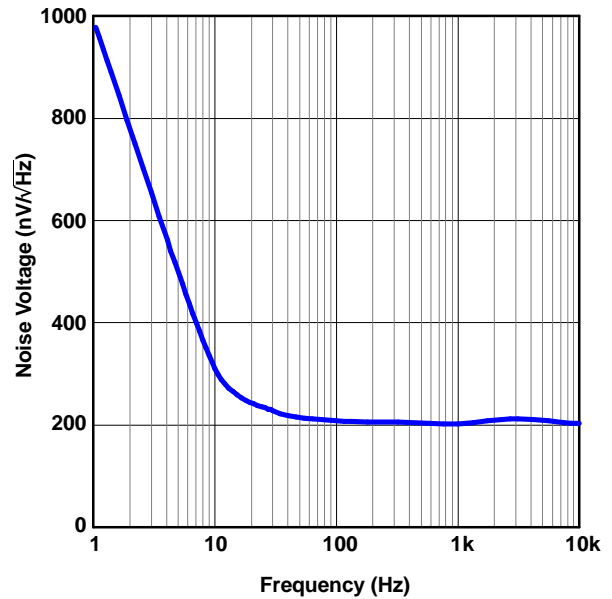

Figure 2. Noise Voltage vs Frequency

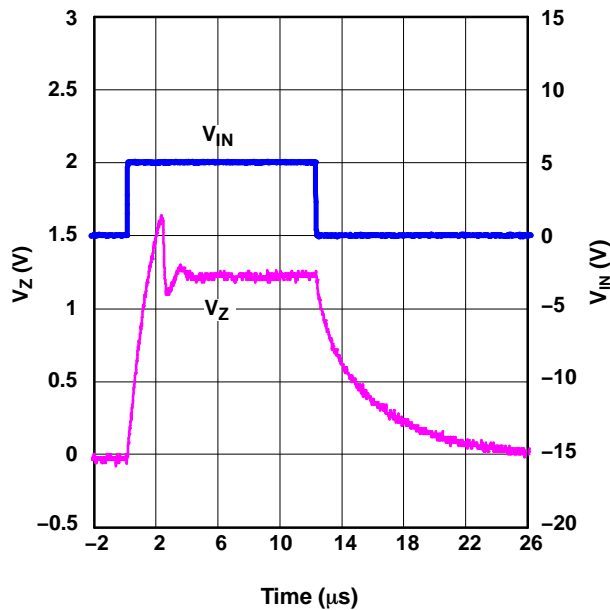

Figure 3. Start-Up Characteristics

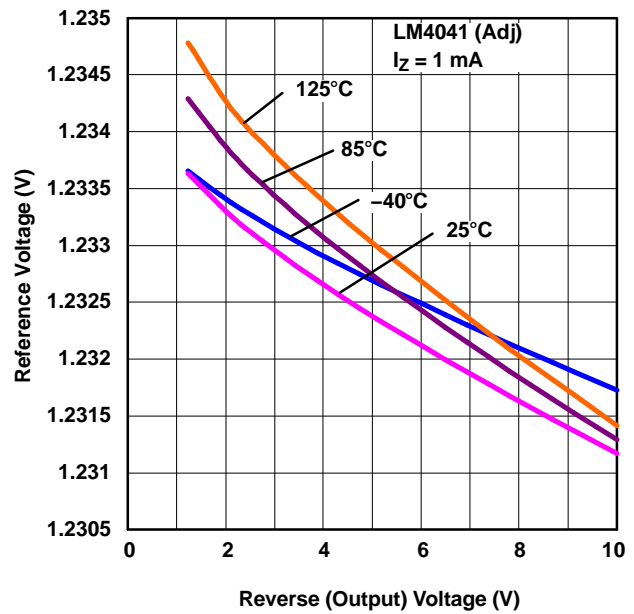

Figure 4. Reference Voltage vs Reverse (Output) Voltage (for Different Temperatures)

TYPICAL CHARACTERISTICS



Figure 5. Reference Voltage vs Temperature (for Different Reverse Voltages)



Figure 6. Feedback Current vs Reverse (Output) Voltage (for Different Temperatures)



Figure 7. Output Impedance vs Frequency



Figure 8. Output Impedance vs Frequency

TYPICAL CHARACTERISTICS



Figure 9. Reverse Characteristics

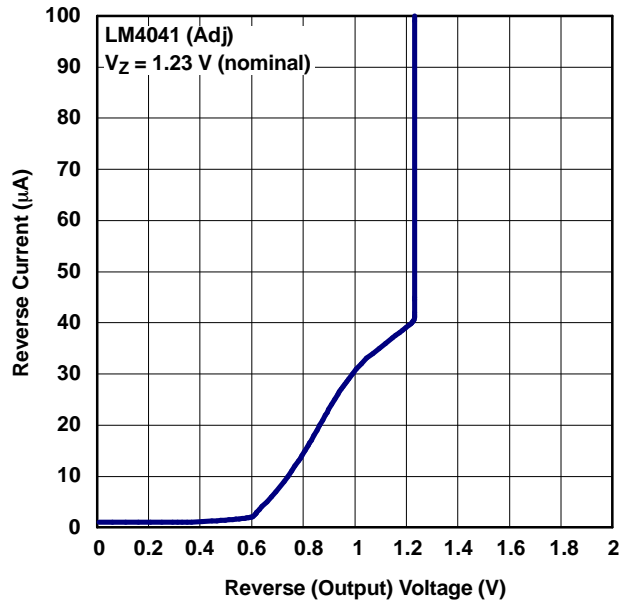

Figure 10. Reverse Characteristics and Minimum Operating Current



Figure 11. Output Saturation vs Output Current

APPLICATION INFORMATION



Figure 12. Startup Characteristics Test Circuit



Figure 13. Reverse Characteristics Test Circuit

Output Capacitor

The LM4041 does not require an output capacitor across CATHODE and ANODE for stability. However, if an output bypass capacitor is desired, the LM4041 is designed to be stable with all capacitive loads.

SOT-23 and SC-70 Pin Connections

There is a parasitic Schottky diode connected between pins 2 and 3 of the SOT-23 packaged device. Thus, pin 3 of the SOT-23 package must be left floating or connected to pin 2. Similarly, pin 2 of the SC-70 package also must be left floating or connected to pin 1.

APPLICATION INFORMATION

Adjustable Version

The adjustable version allows V_Z to be set by a user-defined resistor divider. The output voltage, V_Z , is set according to the equation shown in [Figure 14](#).



Figure 14. Adjustable Shunt Regulator

Cathode and Load Currents

In a typical shunt regulator configuration (see [Figure 15](#)), an external resistor, R_S , is connected between the supply and the cathode of the LM4041. R_S must be set properly, as it sets the total current available to supply the load (I_L) and bias the LM4041 (I_Z). In all cases, I_Z must stay within a specified range for proper operation of the reference. Taking into consideration one extreme in the variation of the load and supply voltage (maximum I_L and minimum V_S), R_S must be small enough to supply the minimum I_Z required for operation of the regulator, as given by data sheet parameters. At the other extreme, maximum V_S and minimum I_L , R_S must be large enough to limit I_Z to less than its maximum recommended rating of 12 mA.

R_S is calculated as shown in [Equation 1](#).

$$R_S = \frac{(V_S - V_Z)}{(I_L + I_Z)} \quad (1)$$



Figure 15. Shunt Regulator

PACKAGING INFORMATION

Orderable Device	Status (1)	Package Type	Package Drawing	Pins	Package Qty	Eco Plan (2)	Lead/Ball Finish (6)	MSL Peak Temp (3)	Op Temp (°C)	Device Marking (4/5)	Samples
LM4041A12IDBZR	ACTIVE	SOT-23	DBZ	3	3000	Green (RoHS & no Sb/Br)	CU NIPDAU	Level-1-260C-UNLIM	-40 to 85	(4MK3, 4MKU)	Samples
LM4041A12IDBZRG4	ACTIVE	SOT-23	DBZ	3	3000	Green (RoHS & no Sb/Br)	CU NIPDAU	Level-1-260C-UNLIM	-40 to 85	(4MK3, 4MKU)	Samples
LM4041A12IDBZT	ACTIVE	SOT-23	DBZ	3	250	Green (RoHS & no Sb/Br)	CU NIPDAU	Level-1-260C-UNLIM	-40 to 85	(4MK3, 4MKU)	Samples
LM4041A12IDCKR	ACTIVE	SC70	DCK	5	3000	Green (RoHS & no Sb/Br)	CU NIPDAU	Level-1-260C-UNLIM	-40 to 85	MKU	Samples
LM4041B12IDBZR	ACTIVE	SOT-23	DBZ	3	3000	Green (RoHS & no Sb/Br)	CU NIPDAU	Level-1-260C-UNLIM	-40 to 85	(4ML3, 4MLU)	Samples
LM4041B12IDBZT	ACTIVE	SOT-23	DBZ	3	250	Green (RoHS & no Sb/Br)	CU NIPDAU	Level-1-260C-UNLIM	-40 to 85	(4ML3, 4MLU)	Samples
LM4041B12IDCKR	ACTIVE	SC70	DCK	5	3000	Green (RoHS & no Sb/Br)	CU NIPDAU	Level-1-260C-UNLIM	-40 to 85	MLU	Samples
LM4041BIDBZR	ACTIVE	SOT-23	DBZ	3	3000	Green (RoHS & no Sb/Br)	CU NIPDAU	Level-1-260C-UNLIM	-40 to 85	(4MG3, 4MGU)	Samples
LM4041BIDBZRG4	ACTIVE	SOT-23	DBZ	3	3000	Green (RoHS & no Sb/Br)	CU NIPDAU	Level-1-260C-UNLIM	-40 to 85	(4MG3, 4MGU)	Samples
LM4041BIDBZT	ACTIVE	SOT-23	DBZ	3	250	Green (RoHS & no Sb/Br)	CU NIPDAU	Level-1-260C-UNLIM	-40 to 85	(4MG3, 4MGU)	Samples
LM4041BIDBZTG4	ACTIVE	SOT-23	DBZ	3	250	Green (RoHS & no Sb/Br)	CU NIPDAU	Level-1-260C-UNLIM	-40 to 85	(4MG3, 4MGU)	Samples
LM4041BIDCKR	ACTIVE	SC70	DCK	5	3000	Green (RoHS & no Sb/Br)	CU NIPDAU	Level-1-260C-UNLIM	-40 to 85	MGU	Samples
LM4041BIDCKT	ACTIVE	SC70	DCK	5	250	Green (RoHS & no Sb/Br)	CU NIPDAU	Level-1-260C-UNLIM	-40 to 85	MGU	Samples
LM4041C12IDBZR	ACTIVE	SOT-23	DBZ	3	3000	Green (RoHS & no Sb/Br)	CU NIPDAU	Level-1-260C-UNLIM	-40 to 85	(4MM3, 4MMU)	Samples
LM4041C12IDBZRG4	ACTIVE	SOT-23	DBZ	3	3000	Green (RoHS & no Sb/Br)	CU NIPDAU	Level-1-260C-UNLIM	-40 to 85	(4MM3, 4MMU)	Samples
LM4041C12IDBZT	ACTIVE	SOT-23	DBZ	3	250	Green (RoHS & no Sb/Br)	CU NIPDAU	Level-1-260C-UNLIM	-40 to 85	(4MM3, 4MMU)	Samples
LM4041C12IDBZTG4	ACTIVE	SOT-23	DBZ	3	250	Green (RoHS & no Sb/Br)	CU NIPDAU	Level-1-260C-UNLIM	-40 to 85	(4MM3, 4MMU)	Samples

Orderable Device	Status (1)	Package Type	Package Drawing	Pins	Package Qty	Eco Plan (2)	Lead/Ball Finish (6)	MSL Peak Temp (3)	Op Temp (°C)	Device Marking (4/5)	Samples
LM4041C12IDCKR	ACTIVE	SC70	DCK	5	3000	Green (RoHS & no Sb/Br)	CU NIPDAU	Level-1-260C-UNLIM	-40 to 85	MMU	Samples
LM4041C12IDCKRE4	ACTIVE	SC70	DCK	5	3000	Green (RoHS & no Sb/Br)	CU NIPDAU	Level-1-260C-UNLIM	-40 to 85	MMU	Samples
LM4041C12IDCKRG4	ACTIVE	SC70	DCK	5	3000	Green (RoHS & no Sb/Br)	CU NIPDAU	Level-1-260C-UNLIM	-40 to 85	MMU	Samples
LM4041C12ILP	ACTIVE	TO-92	LP	3	1000	Pb-Free (RoHS)	CU SN	N / A for Pkg Type	-40 to 85	NPC12I	Samples
LM4041C12ILPR	ACTIVE	TO-92	LP	3	2000	Pb-Free (RoHS)	CU SN	N / A for Pkg Type	-40 to 85	NPC12I	Samples
LM4041C12QDBZR	ACTIVE	SOT-23	DBZ	3	3000	Green (RoHS & no Sb/Br)	CU NIPDAU	Level-1-260C-UNLIM	-40 to 125	(4MS3, 4MSU)	Samples
LM4041C12QDBZRG4	ACTIVE	SOT-23	DBZ	3	3000	Green (RoHS & no Sb/Br)	CU NIPDAU	Level-1-260C-UNLIM	-40 to 125	(4MS3, 4MSU)	Samples
LM4041C12QDBZT	ACTIVE	SOT-23	DBZ	3	250	Green (RoHS & no Sb/Br)	CU NIPDAU	Level-1-260C-UNLIM	-40 to 125	(4MS3, 4MSU)	Samples
LM4041CIDBZR	ACTIVE	SOT-23	DBZ	3	3000	Green (RoHS & no Sb/Br)	CU NIPDAU	Level-1-260C-UNLIM	-40 to 85	(4MH3, 4MHU)	Samples
LM4041CIDBZRG4	ACTIVE	SOT-23	DBZ	3	3000	Green (RoHS & no Sb/Br)	CU NIPDAU	Level-1-260C-UNLIM	-40 to 85	(4MH3, 4MHU)	Samples
LM4041CIDBZT	ACTIVE	SOT-23	DBZ	3	250	Green (RoHS & no Sb/Br)	CU NIPDAU	Level-1-260C-UNLIM	-40 to 85	(4MH3, 4MHU)	Samples
LM4041CIDBZTG4	ACTIVE	SOT-23	DBZ	3	250	Green (RoHS & no Sb/Br)	CU NIPDAU	Level-1-260C-UNLIM	-40 to 85	(4MH3, 4MHU)	Samples
LM4041CIDCKR	ACTIVE	SC70	DCK	5	3000	Green (RoHS & no Sb/Br)	CU NIPDAU	Level-1-260C-UNLIM	-40 to 85	MHU	Samples
LM4041CIDCKT	ACTIVE	SC70	DCK	5	250	Green (RoHS & no Sb/Br)	CU NIPDAU	Level-1-260C-UNLIM	-40 to 85	MHU	Samples
LM4041CILP	ACTIVE	TO-92	LP	3	1000	Pb-Free (RoHS)	CU SN	N / A for Pkg Type	-40 to 85	NPCI	Samples
LM4041CILPE3	ACTIVE	TO-92	LP	3	1000	Pb-Free (RoHS)	CU SN	N / A for Pkg Type	-40 to 85	NPCI	Samples
LM4041CILPR	ACTIVE	TO-92	LP	3	2000	Pb-Free (RoHS)	CU SN	N / A for Pkg Type	-40 to 85	NPCI	Samples
LM4041CQDBZR	ACTIVE	SOT-23	DBZ	3	3000	Green (RoHS & no Sb/Br)	CU NIPDAU	Level-1-260C-UNLIM	-40 to 125	(4MP3, 4MPU)	Samples

Orderable Device	Status (1)	Package Type	Package Drawing	Pins	Package Qty	Eco Plan (2)	Lead/Ball Finish (6)	MSL Peak Temp (3)	Op Temp (°C)	Device Marking (4/5)	Samples
LM4041CQDBZT	ACTIVE	SOT-23	DBZ	3	250	Green (RoHS & no Sb/Br)	CU NIPDAU	Level-1-260C-UNLIM	-40 to 125	(4MP3, 4MPU)	Samples
LM4041CQDBZTG4	ACTIVE	SOT-23	DBZ	3	250	Green (RoHS & no Sb/Br)	CU NIPDAU	Level-1-260C-UNLIM	-40 to 125	(4MP3, 4MPU)	Samples
LM4041D12IDBZR	ACTIVE	SOT-23	DBZ	3	3000	Green (RoHS & no Sb/Br)	CU NIPDAU	Level-1-260C-UNLIM	-40 to 85	(4MN3, 4MNU)	Samples
LM4041D12IDBZRG4	ACTIVE	SOT-23	DBZ	3	3000	Green (RoHS & no Sb/Br)	CU NIPDAU	Level-1-260C-UNLIM	-40 to 85	(4MN3, 4MNU)	Samples
LM4041D12IDBZT	ACTIVE	SOT-23	DBZ	3	250	Green (RoHS & no Sb/Br)	CU NIPDAU	Level-1-260C-UNLIM	-40 to 85	(4MN3, 4MNU)	Samples
LM4041D12IDBZTG4	ACTIVE	SOT-23	DBZ	3	250	Green (RoHS & no Sb/Br)	CU NIPDAU	Level-1-260C-UNLIM	-40 to 85	(4MN3, 4MNU)	Samples
LM4041D12IDCKR	ACTIVE	SC70	DCK	5	3000	Green (RoHS & no Sb/Br)	CU NIPDAU	Level-1-260C-UNLIM	-40 to 85	MNU	Samples
LM4041D12ILP	ACTIVE	TO-92	LP	3	1000	Pb-Free (RoHS)	CU SN	N / A for Pkg Type	-40 to 85	NPD12I	Samples
LM4041D12ILPE3	ACTIVE	TO-92	LP	3	1000	Pb-Free (RoHS)	CU SN	N / A for Pkg Type	-40 to 85	NPD12I	Samples
LM4041D12ILPR	ACTIVE	TO-92	LP	3	2000	Pb-Free (RoHS)	CU SN	N / A for Pkg Type	-40 to 85	NPD12I	Samples
LM4041D12QDBZR	ACTIVE	SOT-23	DBZ	3	3000	Green (RoHS & no Sb/Br)	CU NIPDAU	Level-1-260C-UNLIM	-40 to 125	(4MT3, 4MTU)	Samples
LM4041DIDBZR	ACTIVE	SOT-23	DBZ	3	3000	Green (RoHS & no Sb/Br)	CU NIPDAU	Level-1-260C-UNLIM	-40 to 85	(4MJ3, 4MJU)	Samples
LM4041DIDBZRG4	ACTIVE	SOT-23	DBZ	3	3000	Green (RoHS & no Sb/Br)	CU NIPDAU	Level-1-260C-UNLIM	-40 to 85	(4MJ3, 4MJU)	Samples
LM4041DIDBZT	ACTIVE	SOT-23	DBZ	3	250	Green (RoHS & no Sb/Br)	CU NIPDAU	Level-1-260C-UNLIM	-40 to 85	(4MJ3, 4MJU)	Samples
LM4041DIDBZTG4	ACTIVE	SOT-23	DBZ	3	250	Green (RoHS & no Sb/Br)	CU NIPDAU	Level-1-260C-UNLIM	-40 to 85	(4MJ3, 4MJU)	Samples
LM4041DIDCKR	ACTIVE	SC70	DCK	5	3000	Green (RoHS & no Sb/Br)	CU NIPDAU	Level-1-260C-UNLIM	-40 to 85	MJU	Samples
LM4041DIDCKT	ACTIVE	SC70	DCK	5	250	Green (RoHS & no Sb/Br)	CU NIPDAU	Level-1-260C-UNLIM	-40 to 85	MJU	Samples
LM4041DILP	ACTIVE	TO-92	LP	3	1000	Pb-Free (RoHS)	CU SN	N / A for Pkg Type	-40 to 85	NPDI	Samples

Orderable Device	Status (1)	Package Type	Package Drawing	Pins	Package Qty	Eco Plan (2)	Lead/Ball Finish (6)	MSL Peak Temp (3)	Op Temp (°C)	Device Marking (4/5)	Samples
LM4041DILPR	ACTIVE	TO-92	LP	3	2000	Pb-Free (RoHS)	CU SN	N / A for Pkg Type	-40 to 85	NPDI	Samples
LM4041DQDBZR	ACTIVE	SOT-23	DBZ	3	3000	Green (RoHS & no Sb/Br)	CU NIPDAU	Level-1-260C-UNLIM	-40 to 125	(4MR3, 4MRU)	Samples
LM4041DQDBZRG4	ACTIVE	SOT-23	DBZ	3	3000	Green (RoHS & no Sb/Br)	CU NIPDAU	Level-1-260C-UNLIM	-40 to 125	(4MR3, 4MRU)	Samples
LM4041DQDBZT	ACTIVE	SOT-23	DBZ	3	250	Green (RoHS & no Sb/Br)	CU NIPDAU	Level-1-260C-UNLIM	-40 to 125	(4MR3, 4MRU)	Samples
LM4041DQDBZTG4	ACTIVE	SOT-23	DBZ	3	250	Green (RoHS & no Sb/Br)	CU NIPDAU	Level-1-260C-UNLIM	-40 to 125	(4MR3, 4MRU)	Samples

(1) The marketing status values are defined as follows:

ACTIVE: Product device recommended for new designs.

LIFEBUY: TI has announced that the device will be discontinued, and a lifetime-buy period is in effect.

NRND: Not recommended for new designs. Device is in production to support existing customers, but TI does not recommend using this part in a new design.

PREVIEW: Device has been announced but is not in production. Samples may or may not be available.

OBSELETE: TI has discontinued the production of the device.

(2) **RoHS:** TI defines "RoHS" to mean semiconductor products that are compliant with the current EU RoHS requirements for all 10 RoHS substances, including the requirement that RoHS substance do not exceed 0.1% by weight in homogeneous materials. Where designed to be soldered at high temperatures, "RoHS" products are suitable for use in specified lead-free processes. TI may reference these types of products as "Pb-Free".

RoHS Exempt: TI defines "RoHS Exempt" to mean products that contain lead but are compliant with EU RoHS pursuant to a specific EU RoHS exemption.

Green: TI defines "Green" to mean the content of Chlorine (Cl) and Bromine (Br) based flame retardants meet JS709B low halogen requirements of <=1000ppm threshold. Antimony trioxide based flame retardants must also meet the <=1000ppm threshold requirement.

(3) MSL, Peak Temp. - The Moisture Sensitivity Level rating according to the JEDEC industry standard classifications, and peak solder temperature.

(4) There may be additional marking, which relates to the logo, the lot trace code information, or the environmental category on the device.

(5) Multiple Device Markings will be inside parentheses. Only one Device Marking contained in parentheses and separated by a "~" will appear on a device. If a line is indented then it is a continuation of the previous line and the two combined represent the entire Device Marking for that device.

(6) Lead/Ball Finish - Orderable Devices may have multiple material finish options. Finish options are separated by a vertical ruled line. Lead/Ball Finish values may wrap to two lines if the finish value exceeds the maximum column width.

Important Information and Disclaimer: The information provided on this page represents TI's knowledge and belief as of the date that it is provided. TI bases its knowledge and belief on information provided by third parties, and makes no representation or warranty as to the accuracy of such information. Efforts are underway to better integrate information from third parties. TI has taken and

continues to take reasonable steps to provide representative and accurate information but may not have conducted destructive testing or chemical analysis on incoming materials and chemicals. TI and TI suppliers consider certain information to be proprietary, and thus CAS numbers and other limited information may not be available for release.

In no event shall TI's liability arising out of such information exceed the total purchase price of the TI part(s) at issue in this document sold by TI to Customer on an annual basis.

TAPE AND REEL INFORMATION

QUADRANT ASSIGNMENTS FOR PIN 1 ORIENTATION IN TAPE

*All dimensions are nominal

Device	Package Type	Package Drawing	Pins	SPQ	Reel Diameter (mm)	Reel Width W1 (mm)	A0 (mm)	B0 (mm)	K0 (mm)	P1 (mm)	W (mm)	Pin1 Quadrant
LM4041A12IDBZR	SOT-23	DBZ	3	3000	178.0	9.2	3.15	2.77	1.22	4.0	8.0	Q3
LM4041A12IDBZT	SOT-23	DBZ	3	250	178.0	9.2	3.15	2.77	1.22	4.0	8.0	Q3
LM4041A12IDCKR	SC70	DCK	5	3000	179.0	8.4	2.2	2.5	1.2	4.0	8.0	Q3
LM4041B12IDBZR	SOT-23	DBZ	3	3000	178.0	9.2	3.15	2.77	1.22	4.0	8.0	Q3
LM4041B12IDBZT	SOT-23	DBZ	3	250	178.0	9.2	3.15	2.77	1.22	4.0	8.0	Q3
LM4041B12IDCKR	SC70	DCK	5	3000	179.0	8.4	2.2	2.5	1.2	4.0	8.0	Q3
LM4041BIDBZR	SOT-23	DBZ	3	3000	178.0	9.2	3.15	2.77	1.22	4.0	8.0	Q3
LM4041BIDBZT	SOT-23	DBZ	3	250	178.0	9.2	3.15	2.77	1.22	4.0	8.0	Q3
LM4041BIDCKR	SC70	DCK	5	3000	179.0	8.4	2.2	2.5	1.2	4.0	8.0	Q3
LM4041BIDCKT	SC70	DCK	5	250	179.0	8.4	2.2	2.5	1.2	4.0	8.0	Q3
LM4041C12IDBZR	SOT-23	DBZ	3	3000	178.0	9.2	3.15	2.77	1.22	4.0	8.0	Q3
LM4041C12IDBZT	SOT-23	DBZ	3	250	178.0	9.2	3.15	2.77	1.22	4.0	8.0	Q3
LM4041C12IDCKR	SC70	DCK	5	3000	179.0	8.4	2.2	2.5	1.2	4.0	8.0	Q3
LM4041C12QDBZR	SOT-23	DBZ	3	3000	178.0	9.2	3.15	2.77	1.22	4.0	8.0	Q3
LM4041C12QDBZR	SOT-23	DBZ	3	3000	179.0	8.4	3.15	2.95	1.22	4.0	8.0	Q3
LM4041C12QDBZT	SOT-23	DBZ	3	250	179.0	8.4	3.15	2.95	1.22	4.0	8.0	Q3
LM4041C12QDBZT	SOT-23	DBZ	3	250	178.0	9.2	3.15	2.77	1.22	4.0	8.0	Q3
LM4041CIDBZR	SOT-23	DBZ	3	3000	178.0	9.2	3.15	2.77	1.22	4.0	8.0	Q3

Device	Package Type	Package Drawing	Pins	SPQ	Reel Diameter (mm)	Reel Width W1 (mm)	A0 (mm)	B0 (mm)	K0 (mm)	P1 (mm)	W (mm)	Pin1 Quadrant
LM4041CIDBZT	SOT-23	DBZ	3	250	178.0	9.2	3.15	2.77	1.22	4.0	8.0	Q3
LM4041CIDCKR	SC70	DCK	5	3000	179.0	8.4	2.2	2.5	1.2	4.0	8.0	Q3
LM4041CIDCKT	SC70	DCK	5	250	179.0	8.4	2.2	2.5	1.2	4.0	8.0	Q3
LM4041CQDBZR	SOT-23	DBZ	3	3000	179.0	8.4	3.15	2.95	1.22	4.0	8.0	Q3
LM4041CQDBZR	SOT-23	DBZ	3	3000	178.0	9.2	3.15	2.77	1.22	4.0	8.0	Q3
LM4041CQDBZT	SOT-23	DBZ	3	250	179.0	8.4	3.15	2.95	1.22	4.0	8.0	Q3
LM4041CQDBZT	SOT-23	DBZ	3	250	178.0	9.2	3.15	2.77	1.22	4.0	8.0	Q3
LM4041D12IDBZR	SOT-23	DBZ	3	3000	178.0	9.2	3.15	2.77	1.22	4.0	8.0	Q3
LM4041D12IDBZT	SOT-23	DBZ	3	250	178.0	9.2	3.15	2.77	1.22	4.0	8.0	Q3
LM4041D12IDCKR	SC70	DCK	5	3000	179.0	8.4	2.2	2.5	1.2	4.0	8.0	Q3
LM4041D12QDBZR	SOT-23	DBZ	3	3000	178.0	9.2	3.15	2.77	1.22	4.0	8.0	Q3
LM4041D12QDBZR	SOT-23	DBZ	3	3000	179.0	8.4	3.15	2.95	1.22	4.0	8.0	Q3
LM4041DIDBZR	SOT-23	DBZ	3	3000	178.0	9.2	3.15	2.77	1.22	4.0	8.0	Q3
LM4041DIDBZT	SOT-23	DBZ	3	250	178.0	9.2	3.15	2.77	1.22	4.0	8.0	Q3
LM4041DIDCKR	SC70	DCK	5	3000	179.0	8.4	2.2	2.5	1.2	4.0	8.0	Q3
LM4041DIDCKT	SC70	DCK	5	250	179.0	8.4	2.2	2.5	1.2	4.0	8.0	Q3
LM4041DQDBZR	SOT-23	DBZ	3	3000	179.0	8.4	3.15	2.95	1.22	4.0	8.0	Q3
LM4041DQDBZR	SOT-23	DBZ	3	3000	178.0	9.2	3.15	2.77	1.22	4.0	8.0	Q3
LM4041DQDBZT	SOT-23	DBZ	3	250	178.0	9.2	3.15	2.77	1.22	4.0	8.0	Q3
LM4041DQDBZT	SOT-23	DBZ	3	250	179.0	8.4	3.15	2.95	1.22	4.0	8.0	Q3

TAPE AND REEL BOX DIMENSIONS

*All dimensions are nominal

Device	Package Type	Package Drawing	Pins	SPQ	Length (mm)	Width (mm)	Height (mm)
LM4041A12IDBZR	SOT-23	DBZ	3	3000	180.0	180.0	18.0
LM4041A12IDBZT	SOT-23	DBZ	3	250	180.0	180.0	18.0
LM4041A12IDCKR	SC70	DCK	5	3000	203.0	203.0	35.0
LM4041B12IDBZR	SOT-23	DBZ	3	3000	180.0	180.0	18.0
LM4041B12IDBZT	SOT-23	DBZ	3	250	180.0	180.0	18.0
LM4041B12IDCKR	SC70	DCK	5	3000	203.0	203.0	35.0
LM4041BIDBZR	SOT-23	DBZ	3	3000	180.0	180.0	18.0
LM4041BIDBZT	SOT-23	DBZ	3	250	180.0	180.0	18.0
LM4041BIDCKR	SC70	DCK	5	3000	203.0	203.0	35.0
LM4041BIDCKT	SC70	DCK	5	250	203.0	203.0	35.0
LM4041C12IDBZR	SOT-23	DBZ	3	3000	180.0	180.0	18.0
LM4041C12IDBZT	SOT-23	DBZ	3	250	180.0	180.0	18.0
LM4041C12IDCKR	SC70	DCK	5	3000	203.0	203.0	35.0
LM4041C12QDBZR	SOT-23	DBZ	3	3000	180.0	180.0	18.0
LM4041C12QDBZR	SOT-23	DBZ	3	3000	203.0	203.0	35.0
LM4041C12QDBZT	SOT-23	DBZ	3	250	203.0	203.0	35.0
LM4041C12QDBZT	SOT-23	DBZ	3	250	180.0	180.0	18.0
LM4041CIDBZR	SOT-23	DBZ	3	3000	180.0	180.0	18.0
LM4041CIDBZT	SOT-23	DBZ	3	250	180.0	180.0	18.0
LM4041CIDCKR	SC70	DCK	5	3000	203.0	203.0	35.0
LM4041CIDCKT	SC70	DCK	5	250	203.0	203.0	35.0
LM4041CQDBZR	SOT-23	DBZ	3	3000	203.0	203.0	35.0
LM4041CQDBZR	SOT-23	DBZ	3	3000	180.0	180.0	18.0
LM4041CQDBZT	SOT-23	DBZ	3	250	203.0	203.0	35.0
LM4041CQDBZT	SOT-23	DBZ	3	250	180.0	180.0	18.0
LM4041D12IDBZR	SOT-23	DBZ	3	3000	180.0	180.0	18.0
LM4041D12IDBZT	SOT-23	DBZ	3	250	180.0	180.0	18.0
LM4041D12IDCKR	SC70	DCK	5	3000	203.0	203.0	35.0
LM4041D12QDBZR	SOT-23	DBZ	3	3000	180.0	180.0	18.0
LM4041D12QDBZR	SOT-23	DBZ	3	3000	203.0	203.0	35.0
LM4041DIDBZR	SOT-23	DBZ	3	3000	180.0	180.0	18.0
LM4041DIDBZT	SOT-23	DBZ	3	250	180.0	180.0	18.0
LM4041DIDCKR	SC70	DCK	5	3000	203.0	203.0	35.0
LM4041DIDCKT	SC70	DCK	5	250	203.0	203.0	35.0
LM4041DQDBZR	SOT-23	DBZ	3	3000	203.0	203.0	35.0
LM4041DQDBZR	SOT-23	DBZ	3	3000	180.0	180.0	18.0
LM4041DQDBZT	SOT-23	DBZ	3	250	180.0	180.0	18.0
LM4041DQDBZT	SOT-23	DBZ	3	250	203.0	203.0	35.0

DCK (R-PDSO-G5)

PLASTIC SMALL-OUTLINE PACKAGE



- NOTES:
- A. All linear dimensions are in millimeters.
 - B. This drawing is subject to change without notice.
 - C. Body dimensions do not include mold flash or protrusion. Mold flash and protrusion shall not exceed 0.15 per side.
 - D. Falls within JEDEC MO-203 variation AA.

DCK (R-PDSO-G5)

PLASTIC SMALL OUTLINE



- NOTES:
- All linear dimensions are in millimeters.
 - This drawing is subject to change without notice.
 - Customers should place a note on the circuit board fabrication drawing not to alter the center solder mask defined pad.
 - Publication IPC-7351 is recommended for alternate designs.
 - Laser cutting apertures with trapezoidal walls and also rounding corners will offer better paste release. Customers should contact their board assembly site for stencil design recommendations. Example stencil design based on a 50% volumetric metal load solder paste. Refer to IPC-7525 for other stencil recommendations.

GENERIC PACKAGE VIEW

DBZ 3

SOT-23 - 1.12 mm max height

SMALL OUTLINE TRANSISTOR



Images above are just a representation of the package family, actual package may vary.
Refer to the product data sheet for package details.

4203227/C

DBZ0003A



PACKAGE OUTLINE

SOT-23 - 1.12 mm max height

SMALL OUTLINE TRANSISTOR

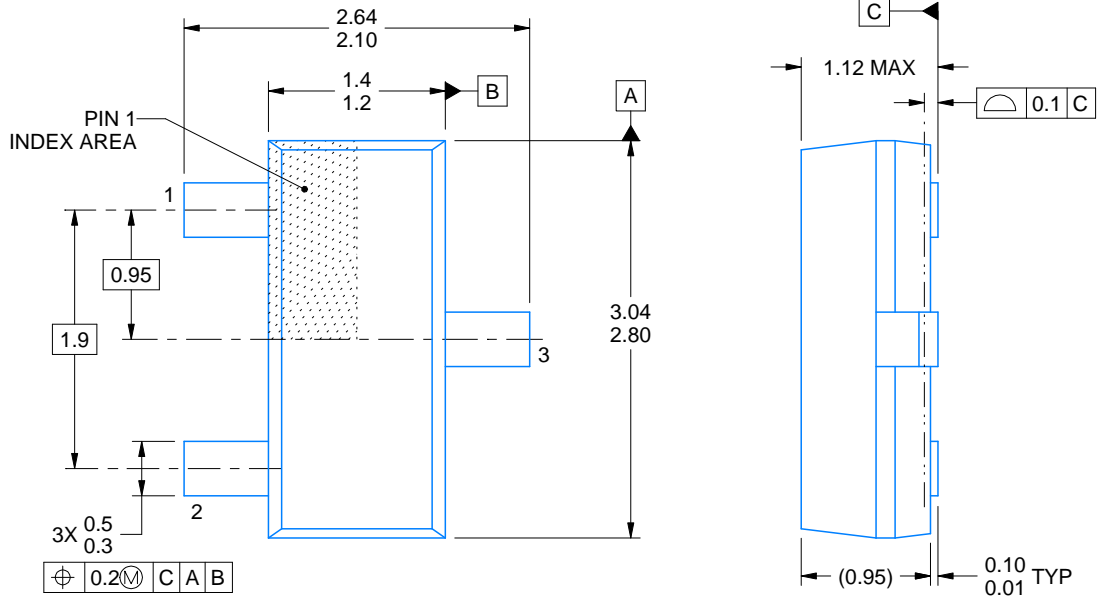

4214838/C 04/2017

NOTES:

1. All linear dimensions are in millimeters. Any dimensions in parenthesis are for reference only. Dimensioning and tolerancing per ASME Y14.5M.
2. This drawing is subject to change without notice.
3. Reference JEDEC registration TO-236, except minimum foot length.

EXAMPLE BOARD LAYOUT

DBZ0003A

SOT-23 - 1.12 mm max height

SMALL OUTLINE TRANSISTOR



LAND PATTERN EXAMPLE
SCALE:15X



SOLDER MASK DETAILS

4214838/C 04/2017

NOTES: (continued)

4. Publication IPC-7351 may have alternate designs.
5. Solder mask tolerances between and around signal pads can vary based on board fabrication site.

EXAMPLE STENCIL DESIGN

DBZ0003A

SOT-23 - 1.12 mm max height

SMALL OUTLINE TRANSISTOR



SOLDER PASTE EXAMPLE
BASED ON 0.125 THICK STENCIL
SCALE:15X

4214838/C 04/2017

NOTES: (continued)

6. Laser cutting apertures with trapezoidal walls and rounded corners may offer better paste release. IPC-7525 may have alternate design recommendations.
7. Board assembly site may have different recommendations for stencil design.

GENERIC PACKAGE VIEW

LP 3

TO-92 - 5.34 mm max height

TRANSISTOR OUTLINE



Images above are just a representation of the package family, actual package may vary.
Refer to the product data sheet for package details.

4040001-2/F

LP0003A



PACKAGE OUTLINE

TO-92 - 5.34 mm max height

TO-92



4215214/B 04/2017

NOTES:

1. All linear dimensions are in millimeters. Any dimensions in parenthesis are for reference only. Dimensioning and tolerancing per ASME Y14.5M.
2. This drawing is subject to change without notice.
3. Lead dimensions are not controlled within this area.
4. Reference JEDEC TO-226, variation AA.
5. Shipping method:
 - a. Straight lead option available in bulk pack only.
 - b. Formed lead option available in tape and reel or ammo pack.
 - c. Specific products can be offered in limited combinations of shipping medium and lead options.
 - d. Consult product folder for more information on available options.



LAND PATTERN EXAMPLE
STRAIGHT LEAD OPTION
NON-SOLDER MASK DEFINED
SCALE:15X



LAND PATTERN EXAMPLE
FORMED LEAD OPTION
NON-SOLDER MASK DEFINED
SCALE:15X

TAPE SPECIFICATIONS

LP0003A

TO-92 - 5.34 mm max height

TO-92

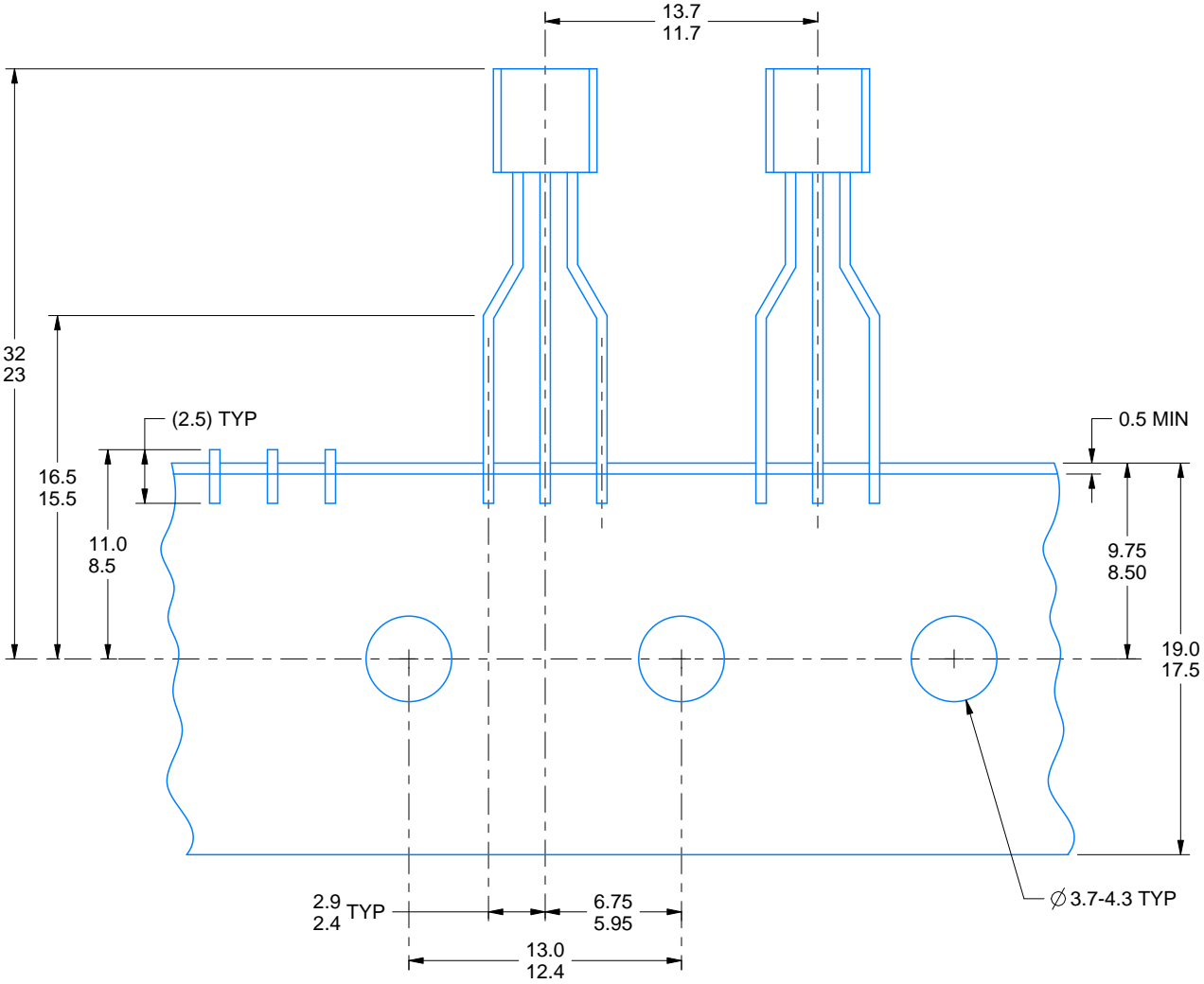

FOR FORMED LEAD OPTION PACKAGE

4215214/B 04/2017

IMPORTANT NOTICE AND DISCLAIMER

TI PROVIDES TECHNICAL AND RELIABILITY DATA (INCLUDING DATASHEETS), DESIGN RESOURCES (INCLUDING REFERENCE DESIGNS), APPLICATION OR OTHER DESIGN ADVICE, WEB TOOLS, SAFETY INFORMATION, AND OTHER RESOURCES "AS IS" AND WITH ALL FAULTS, AND DISCLAIMS ALL WARRANTIES, EXPRESS AND IMPLIED, INCLUDING WITHOUT LIMITATION ANY IMPLIED WARRANTIES OF MERCHANTABILITY, FITNESS FOR A PARTICULAR PURPOSE OR NON-INFRINGEMENT OF THIRD PARTY INTELLECTUAL PROPERTY RIGHTS.

These resources are intended for skilled developers designing with TI products. You are solely responsible for (1) selecting the appropriate TI products for your application, (2) designing, validating and testing your application, and (3) ensuring your application meets applicable standards, and any other safety, security, or other requirements. These resources are subject to change without notice. TI grants you permission to use these resources only for development of an application that uses the TI products described in the resource. Other reproduction and display of these resources is prohibited. No license is granted to any other TI intellectual property right or to any third party intellectual property right. TI disclaims responsibility for, and you will fully indemnify TI and its representatives against, any claims, damages, costs, losses, and liabilities arising out of your use of these resources.

TI's products are provided subject to TI's Terms of Sale (www.ti.com/legal/termsofsale.html) or other applicable terms available either on ti.com or provided in conjunction with such TI products. TI's provision of these resources does not expand or otherwise alter TI's applicable warranties or warranty disclaimers for TI products.

Mailing Address: Texas Instruments, Post Office Box 655303, Dallas, Texas 75265
Copyright © 2019, Texas Instruments Incorporated

Looking for pricing, stock, or lifecycle information?

Click below to explore more details on WIN SOURCE:

 [View LM4041DQDBZT on WIN SOURCE](#)

 [Texas Instruments](#) Information

Optimize Your Supply Chain with WIN SOURCE Solutions

-  Global Sourcing Solution
-  Obsolete Management
-  Cost Control Management
-  Shortage Management
-  Alternative Solution
-  Excess Inventory Management