

1A Variable/Fixed Output LDO Regulators

BAxxBC0 Series(Fixed) BAxxBC0W Series(Fixed) BA00BC0WCP-V5(Variable)

●General Description

The BAxxBC0 are low-saturation regulators with an output current of 1.0 A and an output voltage accuracy of $\pm 2\%$. A broad output voltage range is offered, from 1.5V to 10V, and built-in overcurrent protection and thermal shutdown (TSD) circuits prevent damage due to short-circuiting and overloading, respectively.

●Features

- Output voltage accuracy: $\pm 2\%$
Broad output range available: 1.5 V -10 V (BAxxBC0 series)
- Low saturation-voltage type with PNP output
- Built-in overcurrent protection circuit
- Built-in thermal shutdown circuit
- Integrated shutdown switch (BAxxBC0WT, BAxxBC0WT-5, or BAxxBC0WFP Series, BA00BC0WCP-V5)

●Key Specifications

- Input Power Supply Voltage: 16.0V(Max.)
- Output voltage:(BA00BC0xx) Variable
(BAxxBC0) Fixed
- Output current: 1A(Max.)
- Shutdown current: 0 μ A(Typ.)
- Operating temperature range: -40°C to +105°C

●Applications

All electronic devices that use microcontrollers and logic circuits

●Packages

TO252-3	W (Typ.) x D (Typ.) x H (Max.) 6.50mm x 9.50mm x 2.50mm
TO252-5	6.50mm x 9.50mm x 2.50mm
TO220CP-V5	10.00mm x 20.12mm x 4.60mm
TO220FP-3	10.00mm x 30.50mm x 4.60mm
TO220FP-5	10.00mm x 30.50mm x 4.60mm
TO220FP-5(V5)	10.00mm x 31.50mm x 8.15mm

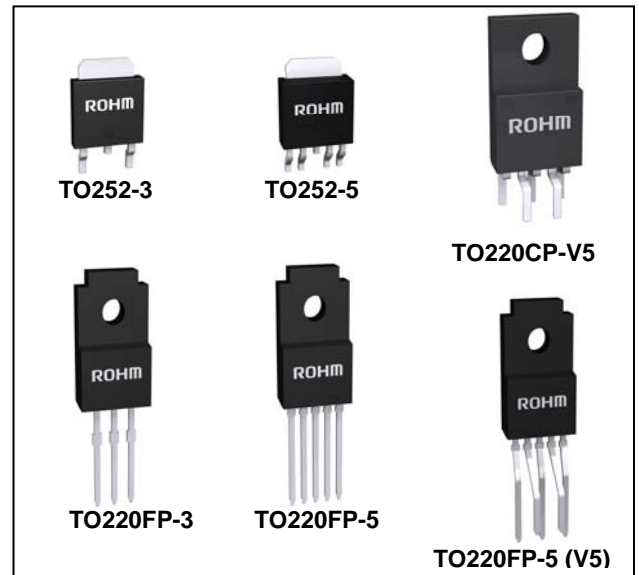

●Lineup Matrix

Part Number	Output Voltage (V)												Package	
	1.5	1.8	2.5	3.0	3.3	5.0	6.0	7.0	8.0	9.0	10.0	Variable		
BAxxBC0WT	○	○	○	○	○	○	○	○	○	○	○	○	○	TO220FP-5
BAxxBC0WT-V5	○	○	○	-	○	○	-	-	-	○	-	○	○	TO220FP-5 (V5)
BAxxBC0WFP	○	○	○	○	○	○	○	○	○	○	○	○	○	TO252-5
BAxxBC0T	○	○	○	○	○	○	○	○	○	○	○	○	-	TO220FP-3
BAxxBC0FP	○	○	○	○	○	○	○	○	○	○	○	○	-	TO252-3
BA00BC0WCP-V5	-	-	-	-	-	-	-	-	-	-	-	○	○	TO220CP-V5

○Product structure : Silicon monolithic integrated circuit ○This product is not designed protection against radioactive rays.

●Lineup

Maximum output current(Max.)	Shutdown Switch	Package		Output voltage(Typ.)	Orderable Part Number	
1A	With Switch	TO252-5	Reel of 2000	1.5 V	BA15BC0WFP-E2	
				1.8 V	BA18BC0WFP-E2	
				2.5 V	BA25BC0WFP-E2	
				3.0 V	BA30BC0WFP-E2	
				3.3 V	BA33BC0WFP-E2	
				5.0 V	BA50BC0WFP-E2	
				6.0 V	BA60BC0WFP-E2	
				7.0 V	BA70BC0WFP-E2	
				8.0 V	BA80BC0WFP-E2	
				9.0 V	BA90BC0WFP-E2	
				10.0 V	BAJ0BC0WFP-E2	
				Variable	BA00BC0WFP-E2	
				TO220FP-5	Tube of 500	1.5 V
		1.8 V	BA18BC0WT			
		2.5 V	BA25BC0WT			
		3.0 V	BA30BC0WT			
		3.3 V	BA33BC0WT			
		5.0 V	BA50BC0WT			
		6.0 V	BA60BC0WT			
		7.0 V	BA70BC0WT			
		8.0 V	BA80BC0WT			
		9.0 V	BA90BC0WT			
		10.0 V	BAJ0BC0WT			
		Variable	BA00BC0WT			
		TO220FP-5 (V5)	Tube of 500			1.5 V
				1.8 V	BA18BC0WT-V5	
				2.5 V	BA25BC0WT-V5	
	3.3 V			BA33BC0WT-V5		
	5.0 V			BA50BC0WT-V5		
	9.0 V			BA90BC0WT-V5		
	Variable	BA00BC0WT-V5				
	TO220CP-V5	Reel of 500	Variable	BA00BC0WCP-V5E2		
	No Switch	TO252-3	Reel of 2000	1.5 V	BA15BC0FP-E2	
				1.8 V	BA18BC0FP-E2	
				2.5 V	BA25BC0FP-E2	
				3.0 V	BA30BC0FP-E2	
				3.3 V	BA33BC0FP-E2	
				5.0 V	BA50BC0FP-E2	
				6.0 V	BA60BC0FP-E2	
				7.0 V	BA70BC0FP-E2	
				8.0 V	BA80BC0FP-E2	
				9.0 V	BA90BC0FP-E2	
10.0 V				BAJ0BC0FP-E2		
TO220FP-3				Tube of 500	1.5 V	BA15BC0T
					1.8 V	BA18BC0T
		2.5 V	BA25BC0T			
		3.0 V	BA30BC0T			
		3.3 V	BA33BC0T			
		5.0 V	BA50BC0T			
		6.0 V	BA60BC0T			
		7.0 V	BA70BC0T			
		8.0 V	BA80BC0T			
		9.0 V	BA90BC0T			
		10.0 V	BAJ0BC0T			

●Block Diagrams / Standard Example Application Circuits / Pin Configurations / Pin Descriptions

[BAxxBC0T] / [BAxxBC0FP]

Fig.1

Pin No.	Pin name	Function
1	Vcc	Supply voltage input
2	N.C./GND	NC pin/GND *1
3	OUT	Voltage output
FIN	GND	GND*2

*1 NC pin for TO252-3 and GND pin for TO220FP-3 and TO220FP-5 (V5).
*2 TO252-3 only.

PIN	External capacitor setting range
Vcc (1Pin)	Approximately 0.33µF.
OUT (3Pin)	22µF to 1000µF

[BAxxBC0WT] / [BAxxBC0WT-V5] / [BAxxBC0WFP]

Fig.2

Pin No.	Pin name	Function
1	CTL	Output voltage on/off control
2	Vcc	Supply voltage input
3	N.C./GND	NC pin/GND*1
4	OUT	Power supply output
5	N.C.	NC pin
FIN	GND	GND*2

*1 NC pin for TO252-5 and GND pin for TO220FP-5 and TO220FP-5 (V5).
*2 TO252-5 only.

PIN	External capacitor setting range
Vcc (2Pin)	Approximately 0.33µF.
OUT (4Pin)	22µF to 1000µF

[BA00BC0WT] / [BA00BC0WCP-V5] / [BA00BC0WFP] / [BA00BC0WT-V5]

Fig.3

Pin No.	Pin name	Function
1	CTL	Output voltage on/off control
2	Vcc	Supply voltage input
3	N.C./GND	NC pin/GND*1
4	OUT	Power supply output
5	C	ADJ pin
FIN	GND	GND*2

*1 NC pin for TO252-5 and GND pin for TO220FP-5 and TO220FP-5 (V5).
*2 TO252-5 only.

PIN	External capacitor setting range
Vcc (2Pin)	Approximately 0.33µF.
OUT (4Pin)	22µF to 1000µF

● Absolute Maximum Ratings (Ta = 25°C)

Parameter	Symbol	Limits	Unit
Power supply voltage	V _{CC}	18 ^{*1}	V
Power dissipation	TO252-3	1200 ^{*2}	mW
	TO252-5	1300 ^{*3}	
	TO220FP-3	2000 ^{*4}	
	TO220FP-5	2000 ^{*4}	
	TO220FP-5 (V5)	2000 ^{*4}	
	TO220CP-V5	2000 ^{*4}	
Operating temperature range	T _{opr}	-40 to +105	°C
Ambient storage temperature	T _{stg}	-55 to +150	°C
Maximum junction temperature	T _{jmax}	150	°C

*1 Must not exceed Pd.

*2 Derated at 9.6mW/°C at Ta>25°C when mounted on a glass epoxy board (70 mm × 70 mm × 1.6 mm).

*3 Derated at 10.4mW/°C at Ta>25°C when mounted on a glass epoxy board (70 mm × 70 mm × 1.6 mm).

*4 Derated at 16mW/°C at Ta > 25°C

● Recommended Operating Ratings

Parameter	Symbol	Min.	Max.	Unit
Input power supply voltage	V _{CC} ^{*5}	3.0	16.0	V
Input power supply voltage	V _{CC} ^{*6}	V _o +1.0	16.0	V
Output current	I _o	-	1	A
Variable output voltage setting value	V _o	1.5	12	V

*5 When output voltage is 1.5 V, 1.8 V, or 2.5 V.

*6 When output voltage is 3.0 V or higher.

● Electrical Characteristics

BAxxBC0 Series BAxxBC0W Series (Unless otherwise specified, Ta = 25°C; V_{CTL} = 3 V; V_{CCDC}^{*7})

Parameter	Symbol	Min.	Typ.	Max.	Unit	Conditions
Output voltage	V _o	V _o (T) × 0.98	V _o (T)	V _o (T) × 1.02	V	I _o = 200mA
Shutdown circuit current	I _{sd}	-	0	10	μA	V _{CTL} = 0 V while in off mode
Minimum I/O voltage difference ^{*8}	ΔV _d	-	0.3	0.5	V	I _o = 200mA, V _{CC} = 0.95 × V _o
Output current capacity	I _o	1	-	-	A	
Input stability ^{*9}	Reg.I	-	15	35	mV	V _{CC} = V _o +1.0V → 16V, I _o = 200mA
Load stability	Reg.L	-	35	75	mV	I _o = 0mA → 1A
Temperature coefficient of output voltage ^{*10}	T _{cvo}	-	±0.02	-	%/°C	I _o = 5mA, T _j = 0°C to 125°C

V_o(T): Set output voltage

*7 V_o = 1.5 V, 1.8 V, 2.5 V : V_{CC} = 3.3 V, V_o = 3.0 V, 3.3 V : V_{CC} = 5 V,

V_o = 5.0 V : V_{CC} = 8 V, V_o = 6.0 V : V_{CC} = 9 V, V_o = 8.0 V : V_{CC} = 11 V,

V_o = 9.0 V : V_{CC} = 12 V, V_o = 10.0 V : V_{CC} = 13 V

*8 V_o ≥ 3.3 V

*9 Change V_{CC} from 3.0 V to 6 V if 1.5 V ≤ V_o ≤ 2.5 V.

*10 Not 100% tested

BA00BC0W Series (Unless otherwise specified, Ta=25°C, V_{CC}=3.3V, V_{CTL}=3V, I_o=200mA, V_o=2.5V setting)

Parameter	Symbol	Min.	Typ.	Max.	Unit	Conditions
Shutdown circuit current	I _{sd}	-	0	10	μA	V _{CTL} = 0V while in OFF mode
Bias Current	I _b	-	0.5	0.9	mA	I _o = 0mA
Reference voltage(CTL terminal)	V _c	1.225	1.250	1.275	V	I _o = 50mA
Minimum I/O voltage difference	ΔV _d	-	0.3	0.5	V	I _o = 500mA, V _{CC} = 2.5V
Output current capacity	I _o	1	-	-	A	
Ripple Rejection	R.R.	44	55	-	dB	f=120Hz, e _{in} ^{*12} =-20dBV, I _o =100mA
Input stability	Reg.I	-	15	30	mV	V _{CC} = V _o + 1.0 V → 16V, I _o = 200mA
Load stability	Reg.L	-	35	75	mV	I _o = 0mA → 1A
Temperature coefficient of output voltage ^{*11}	T _{cvo}	-	±0.02	-	%/°C	I _o = 5mA, T _j =0°C to 125°C
Output Short Current	I _{os}	-	0.40	-	A	V _{CC} =16V
CTL ON Mode Voltage	V _{th1}	2.0	-	-	V	ACTIVE MODE, I _o = 0mA
CTL OFF Mode Voltage	V _{th2}	-	-	0.8	V	OFF MODE, I _o = 0mA
CTL Input Current	I _{in}	40	80	130	μA	I _o = 0mA

*11 Not 100% tested

*12 e_{in}=Input Voltage Ripple

● Typical Performance Curves (Unless otherwise specified, Ta = 25°C, Vcc = 8 V, VCTL = 2 V, Io = 0 mA)

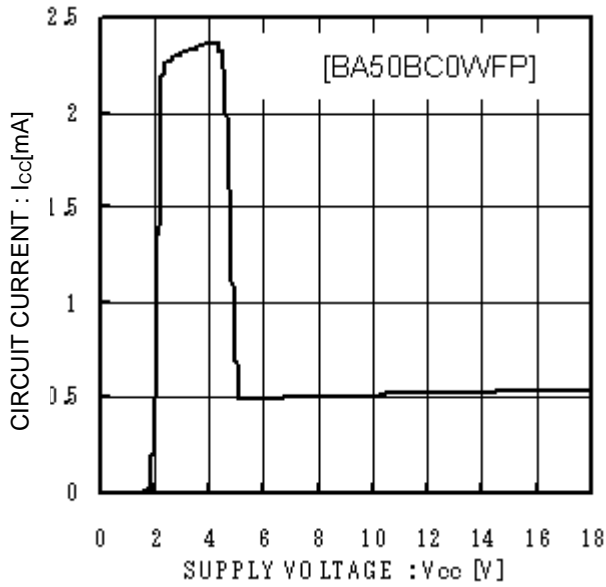

Fig.4
Circuit Current

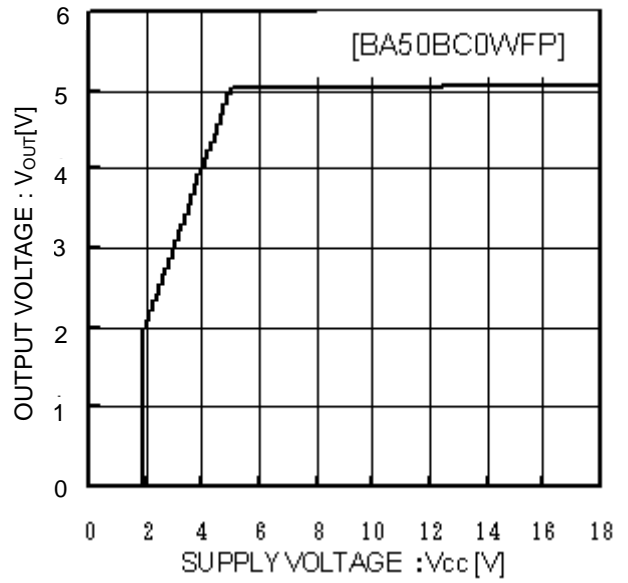

Fig.5
Input Stability (Io=0mA)

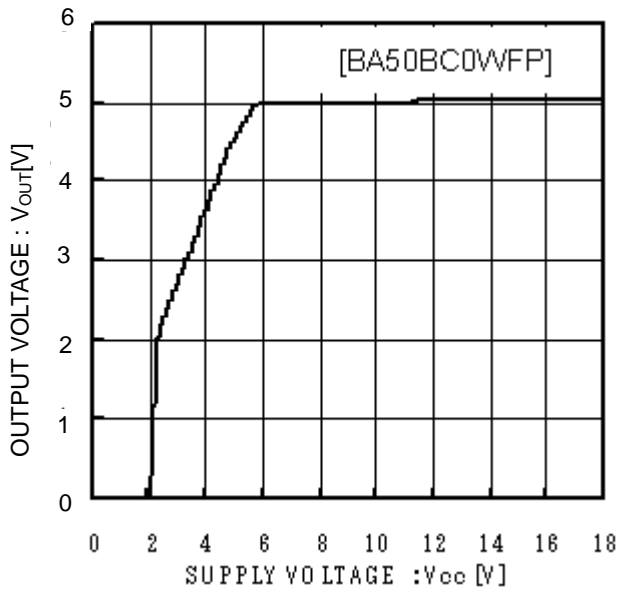

Fig.6
Input Stability (Io = 1 A)



Fig.7
Load Stability

● Typical Performance Curves - continued

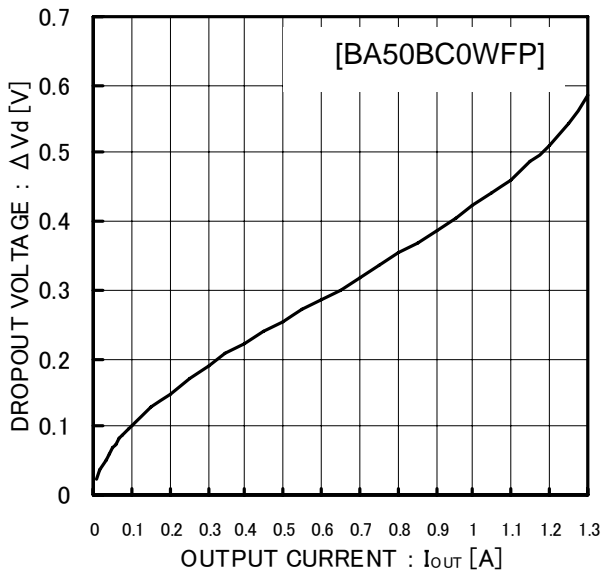

Fig.8
I/O Voltage Difference



Fig.9
Ripple Rejection

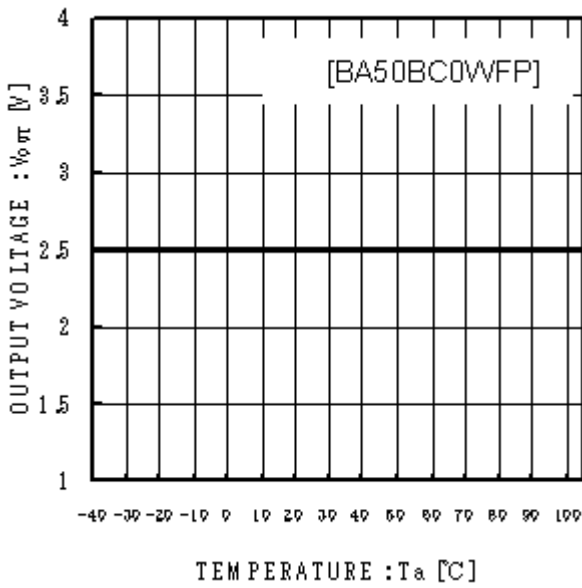

Fig.10
Output Voltage vs Temperature

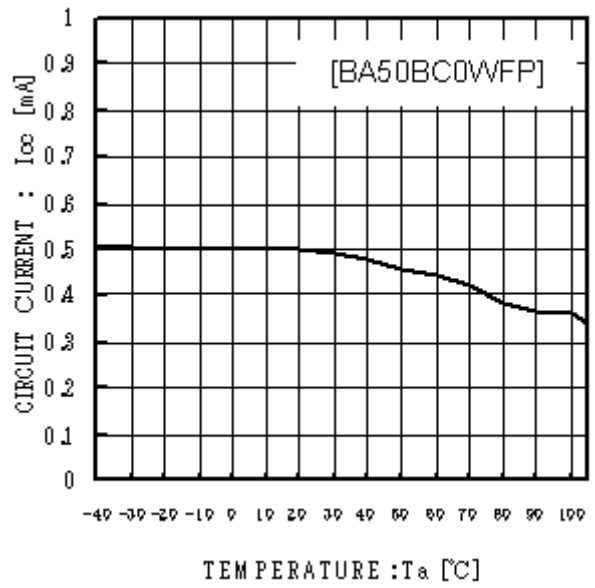

Fig.11
Circuit Current Temperature

● Typical Performance Curves - continued



Fig.12
Circuit Current Classified by Load



Fig.13
CTL Voltage vs Output Voltage



Fig.14
CTL Voltage vs CTL Current



Fig.15
Thermal Shutdown Circuit

Application Information

● I/O equivalence circuit



● Power Dissipation



Fig.18



Fig.19

The characteristics of the IC are greatly influenced by the operating temperature. If the temperature exceeds the maximum junction temperature T_{jmax} , deterioration or damage may occur. Implement proper thermal designs to ensure that power dissipation is within the permissible range in order to prevent instantaneous damage resulting from heat and maintain the reliability of the IC for long-term operation.

The following method is used to calculate the power consumption P_c (W).

$$P_c = (V_{cc} - V_o) \times I_o + V_{cc} \times I_{cca}$$

Power dissipation $P_d \geq P_c$

V_{cc} : Input voltage
 V_o : Output current
 I_o : Load current
 I_{cca} : Circuit current

The load current I_o is calculated:

$$I_o \leq \frac{P_d - V_{cc} \times I_{cca}}{V_{cc} - V_o}$$

Calculation Example:

$V_{cc} = 6.0$ V and $V_o = 5.0$ V at $T_a = 85^\circ\text{C}$

$$I_o \leq \frac{0.676 - 6.0 \times I_{cca}}{6.0 - 5.0}$$

$$\left(\begin{array}{l} \theta_{ja} = 96.2^\circ\text{C/W} \rightarrow -10.4\text{mW}/^\circ\text{C} \\ 25^\circ\text{C} = 1300\text{mW} \rightarrow 85^\circ\text{C} = 676\text{mW} \end{array} \right)$$

$$I_o \leq 550\text{mA} \quad (I_{cca} \approx 20\text{mA})$$

Refer to the above and implement proper thermal designs so that the IC will not be used under excessive power dissipation conditions under the entire operating temperature range.

The power consumption P_c of the IC in the event of shorting (i.e. the V_o and GND pins are shorted) can be obtained from the following equation:

$$P_c = V_{cc} \times (I_{cca} + I_{short}) \quad (I_{short}: \text{short current}).$$

●Peripheral Circuit Considerations

• Vcc pin

Insert a capacitor (0.33μF approx.) between V_{CC} and GND.

The capacitance will vary depending on the application. Use a suitable capacitance and implement designs with sufficient margins.

• GND pin

Verify that there is no potential difference between the ground of the application board and the IC.

If there is a potential difference, the set voltage will not be output accurately, resulting in unstable IC operation. Therefore, lower the impedance by designing the ground pattern as wide and as short as possible.

• CTL terminal



Fig.20 Input Equivalent Circuit

The CTL terminal turns on at an operating power supply voltage of 2.0 V or higher and turns off at 0.8 V or lower.

There is no particular order when turning the power supply and CTL terminals on or off.

●Vo Terminal

Insert a capacitor between the V_o and GND pins in order to prevent output oscillation.

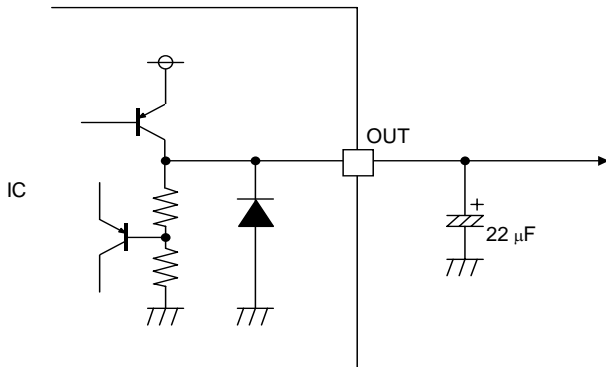

Fig.21 Output Equivalent Circuit



Fig.22 ESR vs. I_o (22μF)

The capacitance may vary greatly with temperature changes, thus making it impossible to completely prevent oscillation. Therefore, use a tantalum aluminum electrolytic capacitor with a low ESR (Equivalent Serial Resistance). The output will oscillate if the ESR is too high or too low, so refer to the ESR characteristics in Fig.22 and operate the IC within the stable region. Use a capacitor within a capacitance between 22μF and 1,000μF.

Below figure, it is ESR-to- I_o stability Area characteristics, measured by 22μ F -ceramic-capacitor and resistor connected in series.

This characteristic is not equal value perfectly to 22μ F -aluminum electrolytic capacitor in order to measurement method.

Note, however, that the stable range suggested in the figure depends on the IC and the resistance load involved, and can vary with the board's wiring impedance, input impedance, and/or load impedance. Therefore, be certain to ascertain the final status of these items for actual use.

Keep capacitor capacitance within a range of 22μF to 1000μF. It is also recommended that a 0.33μF bypass capacitor be connected as close to the input pin-GND as location possible. However, in situations such as rapid fluctuation of the input voltage or the load, please check the operation in real application to determine proper capacitance.

●Operational Notes

1. Absolute maximum ratings
An excess in the absolute maximum ratings, such as supply voltage, temperature range of operating conditions, etc., can break down the devices, thus making impossible to identify breaking mode, such as a short circuit or an open circuit. If any over rated values will expect to exceed the absolute maximum ratings, consider adding circuit protection devices, such as fuses.
2. GND voltage
The potential of GND pin must be minimum potential in all operating conditions.
3. Thermal design
Use a thermal design that allows for a sufficient margin in light of the power dissipation (Pd) in actual operating conditions.
4. Inter-pin shorts and mounting errors
Use caution when positioning the IC for mounting on printed circuit boards.
The IC may be damaged if there is any connection error or if pins are shorted together.
5. Actions in strong electromagnetic field
Use caution when using the IC in the presence of a strong electromagnetic field as doing so may cause the IC to malfunction.
6. Testing on application boards
When testing the IC on an application board, connecting a capacitor to a pin with low impedance subjects the IC to stress. Always discharge capacitors after each process or step. Always turn the IC's power supply off before connecting it to or removing it from a jig or fixture during the inspection process. Ground the IC during assembly steps as an antistatic measure. Use similar precaution when transporting or storing the IC.
7. Regarding input pin of the IC
This monolithic IC contains P+ isolation and P substrate layers between adjacent elements in order to keep them isolated.
P-N junctions are formed at the intersection of these P layers with the N layers of other elements, creating a parasitic diode or transistor. For example, the relation between each potential is as follows:
When $GND > PIN A$ and $GND > PIN B$, the P-N junction operates as a parasitic diode.
When $GND > PIN B$, the P-N junction operates as a parasitic transistor.
Parasitic diodes can occur inevitable in the structure of the IC. The operation of parasitic diodes can result in mutual interference among circuits, operational faults, or physical damage. Accordingly, methods by which parasitic diodes operate, such as applying a voltage that is lower than the GND (P substrate) voltage to an input pin, should not be used.
8. Ground Wiring Pattern
When using both small signal and large current GND patterns, it is recommended to isolate the two ground patterns, placing a single ground point at the ground potential of application so that the pattern wiring resistance and voltage variations caused by large currents do not cause variations in the small signal ground voltage. Be careful not to change the GND wiring pattern of any external components, either.
9. Thermal shutdown circuit
The IC incorporates a built-in thermal shutdown circuit (TSD circuit). The thermal shutdown circuit (TSD circuit) is designed only to shut the IC off to prevent thermal runaway. It is not designed to protect the IC or guarantee its operation. Do not continue to use the IC after operating this circuit or use the IC in an environment where the operation of this circuit is assumed.
10. Overcurrent Protection Circuit
An overcurrent protection circuit is incorporated in order to prevention destruction due to short-time overload currents. Continued use of the protection circuits should be avoided. Please note that the current increases negatively impact the temperature.
11. Damage to the internal circuit or element may occur when the polarity of the Vcc pin is opposite to that of the other pins in applications. (I.e. Vcc is shorted with the GND pin while an external capacitor is charged.) Use a maximum capacitance of 1000 μ F for the output pins. Inserting a diode to prevent back-current flow in series with Vcc or bypass diodes between Vcc and each pin is recommended.



Fig.23 Bypass Diode

Fig.24 Example of Simple Bipolar IC Architecture

Status of this document

The Japanese version of this document is formal specification. A customer may use this translation version only for a reference to help reading the formal version.
 If there are any differences in translation version of this document formal version takes priority.

●Ordering Information

B A x x B C 0 x x x				-	E2
Part Number	Output voltage 00:Variable Other:Fixed	Current capacity BC0 : 1A	Shutdown switch W : Include None:Without	Packages FP : TO252-3 TO252-5 T : TO220FP-3 TO220FP-5 TO220FP-5(V5) CP : TO220CP-V5	Packaging and forming specification E2: Embossed tape and reel None: Container tube

●Physical Dimension Tape and Reel Information

TO252-3

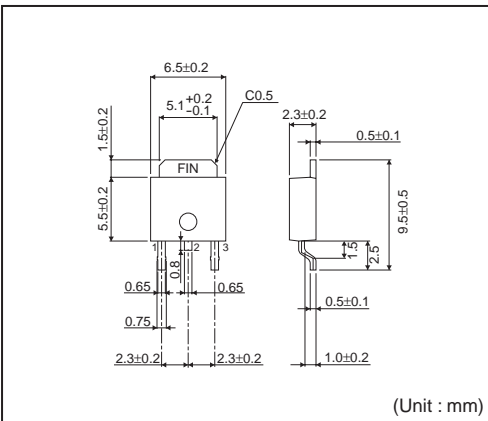

<Tape and Reel information>

Tape	Embossed carrier tape
Quantity	2000pcs
Direction of feed	E2 (The direction is the 1pin of product is at the lower left when you hold reel on the left hand and you pull out the tape on the right hand)

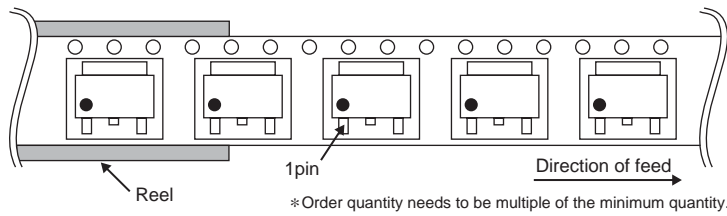

TO252-5



<Tape and Reel information>

Tape	Embossed carrier tape
Quantity	2000pcs
Direction of feed	E2 (The direction is the 1pin of product is at the lower left when you hold reel on the left hand and you pull out the tape on the right hand)

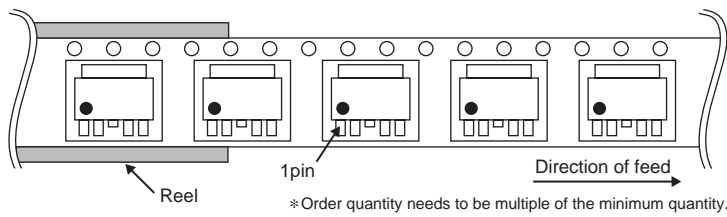

TO220CP-V5



<Tape and Reel information>

Tape	Embossed carrier tape
Quantity	500pcs
Direction of feed	E2 (The direction is the 1pin of product is at the lower left when you hold reel on the left hand and you pull out the tape on the right hand)

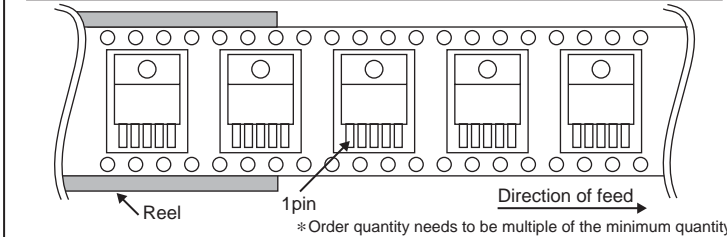

TO220FP-3



<Tape and Reel information>

Container	Tube
Quantity	500pcs
Direction of feed	Direction of products is fixed in a container tube



*Order quantity needs to be multiple of the minimum quantity.

TO220FP-5

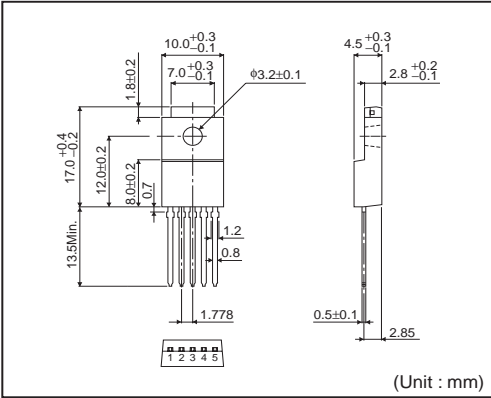

<Tape and Reel information>

Container	Tube
Quantity	500pcs
Direction of feed	Direction of products is fixed in a container tube

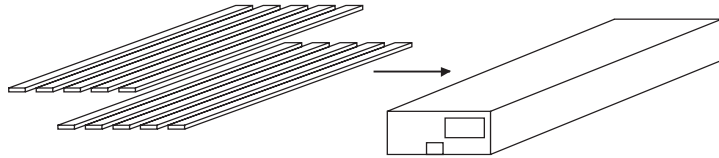

*Order quantity needs to be multiple of the minimum quantity.

TO220FP-5(V5)

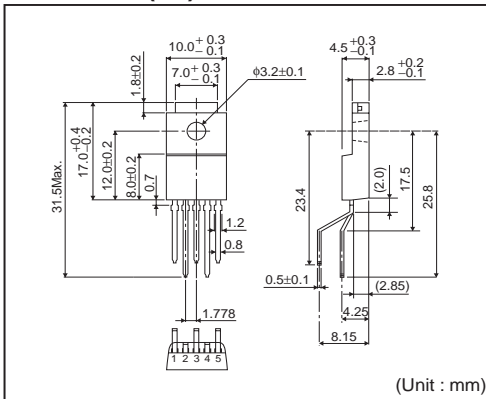

<Tape and Reel information>

Container	Tube
Quantity	500pcs
Direction of feed	Direction of products is fixed in a container tube

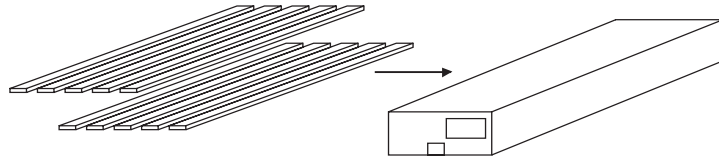

* Order quantity needs to be multiple of the minimum quantity.

●Marking Diagrams

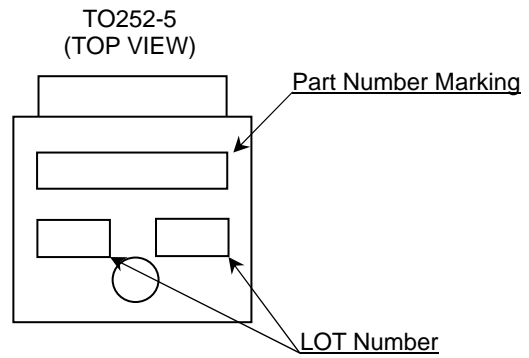
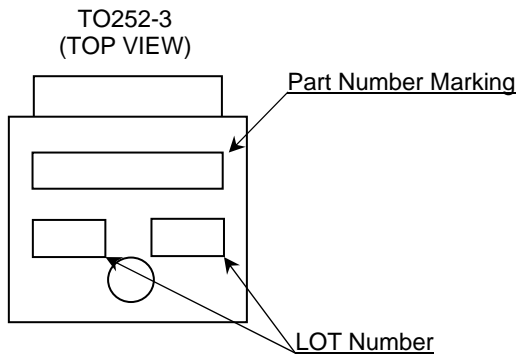

Orderable Part Number	Package	Part Number Marking
BA15BC0WFP-E2	TO252-5	15BC0W
BA18BC0WFP-E2		18BC0W
BA25BC0WFP-E2		25BC0W
BA30BC0WFP-E2		30BC0W
BA33BC0WFP-E2		33BC0W
BA50BC0WFP-E2		50BC0W
BA60BC0WFP-E2		60BC0W
BA70BC0WFP-E2		70BC0W
BA80BC0WFP-E2		80BC0W
BA90BC0WFP-E2		90BC0W
BAJ0BC0WFP-E2		J0BC0W
BA00BC0WFP-E2		00BC0W
BA15BC0WT		TO220FP-5
BA18BC0WT	18BC0W	
BA25BC0WT	25BC0W	
BA30BC0WT	30BC0W	
BA33BC0WT	33BC0W	
BA50BC0WT	50BC0W	
BA60BC0WT	60BC0W	
BA70BC0WT	70BC0W	
BA80BC0WT	80BC0W	
BA90BC0WT	90BC0W	
BAJ0BC0WT	J0BC0W	
BA00BC0WT	00BC0W	
BA15BC0WT-V5	TO220FP-5 (V5)	
BA18BC0WT-V5		18BC0W
BA25BC0WT-V5		25BC0W
BA33BC0WT-V5		33BC0W
BA50BC0WT-V5		50BC0W
BA90BC0WT-V5		90BC0W
BA00BC0WT-V5		00BC0W
BA00BC0WCP-V5E2	TO220CP-V5	00BC0W
BA15BC0FP-E2	TO252-3	BA15BC0
BA18BC0FP-E2		BA18BC0
BA25BC0FP-E2		BA25BC0
BA30BC0FP-E2		BA30BC0
BA33BC0FP-E2		BA33BC0
BA50BC0FP-E2		BA50BC0
BA60BC0FP-E2		BA60BC0
BA70BC0FP-E2		BA70BC0
BA80BC0FP-E2		BA80BC0
BA90BC0FP-E2		BA90BC0
BAJ0BC0FP-E2		BAJ0BC0
BA15BC0T	TO220FP-3	BA15BC0
BA18BC0T		BA18BC0
BA25BC0T		BA25BC0
BA30BC0T		BA30BC0
BA33BC0T		BA33BC0
BA50BC0T		BA50BC0
BA60BC0T		BA60BC0
BA70BC0T		BA70BC0
BA80BC0T		BA80BC0
BA90BC0T		BA90BC0
BAJ0BC0T		BAJ0BC0

●Revision History

Date	Revision	Changes
26.Jun.2012	001	New Release

Notice

Precaution on using ROHM Products

- Our Products are designed and manufactured for application in ordinary electronic equipments (such as AV equipment, OA equipment, telecommunication equipment, home electronic appliances, amusement equipment, etc.). If you intend to use our Products in devices requiring extremely high reliability (such as medical equipment ^(Note 1), transport equipment, traffic equipment, aircraft/spacecraft, nuclear power controllers, fuel controllers, car equipment including car accessories, safety devices, etc.) and whose malfunction or failure may cause loss of human life, bodily injury or serious damage to property ("Specific Applications"), please consult with the ROHM sales representative in advance. Unless otherwise agreed in writing by ROHM in advance, ROHM shall not be in any way responsible or liable for any damages, expenses or losses incurred by you or third parties arising from the use of any ROHM's Products for Specific Applications.

(Note1) Medical Equipment Classification of the Specific Applications

JAPAN	USA	EU	CHINA
CLASS III	CLASS III	CLASS II b	CLASS III
CLASS IV		CLASS III	

- ROHM designs and manufactures its Products subject to strict quality control system. However, semiconductor products can fail or malfunction at a certain rate. Please be sure to implement, at your own responsibilities, adequate safety measures including but not limited to fail-safe design against the physical injury, damage to any property, which a failure or malfunction of our Products may cause. The following are examples of safety measures:
 - Installation of protection circuits or other protective devices to improve system safety
 - Installation of redundant circuits to reduce the impact of single or multiple circuit failure
- Our Products are designed and manufactured for use under standard conditions and not under any special or extraordinary environments or conditions, as exemplified below. Accordingly, ROHM shall not be in any way responsible or liable for any damages, expenses or losses arising from the use of any ROHM's Products under any special or extraordinary environments or conditions. If you intend to use our Products under any special or extraordinary environments or conditions (as exemplified below), your independent verification and confirmation of product performance, reliability, etc. prior to use, must be necessary:
 - Use of our Products in any types of liquid, including water, oils, chemicals, and organic solvents
 - Use of our Products outdoors or in places where the Products are exposed to direct sunlight or dust
 - Use of our Products in places where the Products are exposed to sea wind or corrosive gases, including Cl₂, H₂S, NH₃, SO₂, and NO₂
 - Use of our Products in places where the Products are exposed to static electricity or electromagnetic waves
 - Use of our Products in proximity to heat-producing components, plastic cords, or other flammable items
 - Sealing or coating our Products with resin or other coating materials
 - Use of our Products without cleaning residue of flux (even if you use no-clean type fluxes, cleaning residue of flux is recommended); or Washing our Products by using water or water-soluble cleaning agents for cleaning residue after soldering
 - Use of the Products in places subject to dew condensation
- The Products are not subject to radiation-proof design.
- Please verify and confirm characteristics of the final or mounted products in using the Products.
- In particular, if a transient load (a large amount of load applied in a short period of time, such as pulse. is applied, confirmation of performance characteristics after on-board mounting is strongly recommended. Avoid applying power exceeding normal rated power; exceeding the power rating under steady-state loading condition may negatively affect product performance and reliability.
- De-rate Power Dissipation (Pd) depending on Ambient temperature (Ta). When used in sealed area, confirm the actual ambient temperature.
- Confirm that operation temperature is within the specified range described in the product specification.
- ROHM shall not be in any way responsible or liable for failure induced under deviant condition from what is defined in this document.

Precaution for Mounting / Circuit board design

- When a highly active halogenous (chlorine, bromine, etc.) flux is used, the residue of flux may negatively affect product performance and reliability.
- In principle, the reflow soldering method must be used; if flow soldering method is preferred, please consult with the ROHM representative in advance.

For details, please refer to ROHM Mounting specification

Precautions Regarding Application Examples and External Circuits

1. If change is made to the constant of an external circuit, please allow a sufficient margin considering variations of the characteristics of the Products and external components, including transient characteristics, as well as static characteristics.
2. You agree that application notes, reference designs, and associated data and information contained in this document are presented only as guidance for Products use. Therefore, in case you use such information, you are solely responsible for it and you must exercise your own independent verification and judgment in the use of such information contained in this document. ROHM shall not be in any way responsible or liable for any damages, expenses or losses incurred by you or third parties arising from the use of such information.

Precaution for Electrostatic

This Product is electrostatic sensitive product, which may be damaged due to electrostatic discharge. Please take proper caution in your manufacturing process and storage so that voltage exceeding the Products maximum rating will not be applied to Products. Please take special care under dry condition (e.g. Grounding of human body / equipment / solder iron, isolation from charged objects, setting of ionizer, friction prevention and temperature / humidity control).

Precaution for Storage / Transportation

1. Product performance and soldered connections may deteriorate if the Products are stored in the places where:
 - [a] the Products are exposed to sea winds or corrosive gases, including Cl₂, H₂S, NH₃, SO₂, and NO₂
 - [b] the temperature or humidity exceeds those recommended by ROHM
 - [c] the Products are exposed to direct sunshine or condensation
 - [d] the Products are exposed to high Electrostatic
2. Even under ROHM recommended storage condition, solderability of products out of recommended storage time period may be degraded. It is strongly recommended to confirm solderability before using Products of which storage time is exceeding the recommended storage time period.
3. Store / transport cartons in the correct direction, which is indicated on a carton with a symbol. Otherwise bent leads may occur due to excessive stress applied when dropping of a carton.
4. Use Products within the specified time after opening a humidity barrier bag. Baking is required before using Products of which storage time is exceeding the recommended storage time period.

Precaution for Product Label

QR code printed on ROHM Products label is for ROHM's internal use only.

Precaution for Disposition

When disposing Products please dispose them properly using an authorized industry waste company.

Precaution for Foreign Exchange and Foreign Trade act

Since our Products might fall under controlled goods prescribed by the applicable foreign exchange and foreign trade act, please consult with ROHM representative in case of export.

Precaution Regarding Intellectual Property Rights

1. All information and data including but not limited to application example contained in this document is for reference only. ROHM does not warrant that foregoing information or data will not infringe any intellectual property rights or any other rights of any third party regarding such information or data. ROHM shall not be in any way responsible or liable for infringement of any intellectual property rights or other damages arising from use of such information or data.:
2. No license, expressly or implied, is granted hereby under any intellectual property rights or other rights of ROHM or any third parties with respect to the information contained in this document.

Other Precaution

1. This document may not be reprinted or reproduced, in whole or in part, without prior written consent of ROHM.
2. The Products may not be disassembled, converted, modified, reproduced or otherwise changed without prior written consent of ROHM.
3. In no event shall you use in any way whatsoever the Products and the related technical information contained in the Products or this document for any military purposes, including but not limited to, the development of mass-destruction weapons.
4. The proper names of companies or products described in this document are trademarks or registered trademarks of ROHM, its affiliated companies or third parties.

General Precaution

1. Before you use our Products, you are requested to carefully read this document and fully understand its contents. ROHM shall not be in any way responsible or liable for failure, malfunction or accident arising from the use of any ROHM's Products against warning, caution or note contained in this document.
2. All information contained in this document is current as of the issuing date and subject to change without any prior notice. Before purchasing or using ROHM's Products, please confirm the latest information with a ROHM sales representative.
3. The information contained in this document is provided on an "as is" basis and ROHM does not warrant that all information contained in this document is accurate and/or error-free. ROHM shall not be in any way responsible or liable for any damages, expenses or losses incurred by you or third parties resulting from inaccuracy or errors of or concerning such information.

Looking for pricing, stock, or lifecycle information?

Click below to explore more details on WIN SOURCE:

- ⊖ [View BA00BC0WT-V5 on WIN SOURCE](#)
- ⊖ [Rohm Semiconductor](#) Information

Optimize Your Supply Chain with WIN SOURCE Solutions

- ✓ Global Sourcing Solution
- ✓ Obsolete Management
- ✓ Cost Control Management
- ✓ Shortage Management
- ✓ Alternative Solution
- ✓ Excess Inventory Management