



**THE DATASHEET OF
ZXTN08400BFFTA**



400V NPN MEDIUM POWER HIGH VOLTAGE TRANSISTOR IN SOT23F
Features

- $BV_{CEX} > 450V$
- $BV_{CEO} > 400V$
- $BV_{ECO} > 6V$
- $I_C = 0.5A$ Continuous Collector Current
- Low Saturation Voltage $V_{CE(SAT)} < 175mV @ 500mA$
- 1.5W Power Dissipation
- Complementary PNP Type: ZXP08400BFF
- **Totally Lead-Free & Fully RoHS Compliant (Notes 1 & 2)**
- **Halogen and Antimony Free. "Green" Device (Note 3)**
- **Qualified to AEC-Q101 Standards for High Reliability**

Description

This NPN transistor has been designed for applications requiring high voltage blocking. The SOT23F package is pin compatible with the industry standard SOT23 foot print but offers lower profile and higher power dissipation for applications where power density is of utmost importance.

Mechanical Data

- Case: SOT23F
- Case Material: Molded Plastic. "Green" Molding Compound. UL Flammability Classification Rating 94V-0
- Moisture Sensitivity: Level 1 per J-STD-020
- Terminals: Finish – Matte Tin Plated Leads, Solderable per MIL-STD-202, Method 208 (E3)
- Weight: 0.012 grams (Approximate)

Applications

- High Voltage
- Low Saturation Voltage
- Low Profile Small Package Outline

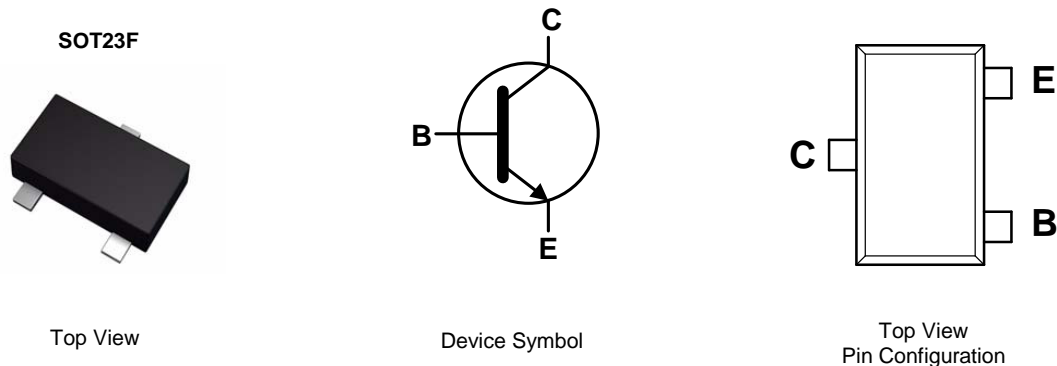
Ordering Information (Note 4)

Product	Compliance	Marking	Reel Size (inches)	Tape Width (mm)	Quantity per Reel
ZXTN08400BFFTA	AEC-Q101	1D5	7	8	3,000

- Notes:
1. No purposely added lead. Fully EU Directive 2002/95/EC (RoHS) & 2011/65/EU (RoHS 2) compliant.
 2. See http://www.diodes.com/quality/lead_free.html for more information about Diodes Incorporated's definitions of Halogen- and Antimony-free, "Green" and Lead-free.
 3. Halogen- and Antimony-free "Green" products are defined as those which contain <900ppm bromine, <900ppm chlorine (<1500ppm total Br + Cl) and <1000ppm antimony compounds.
 4. For packaging details, go to our website at <http://www.diodes.com/products/packages.html>.

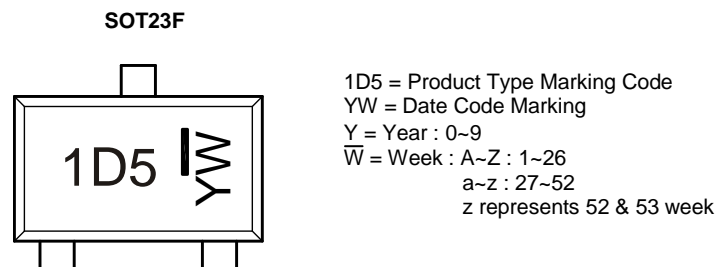
Marking Information

Absolute Maximum Ratings (@T_A = +25°C, unless otherwise specified.)

Characteristic	Symbol	Value	Unit
Collector-Base Voltage	V _{CB0}	450	V
Collector-Emitter Voltage (Forward Blocking)	V _{CEx}	450	V
Collector-Emitter Voltage	V _{CEO}	400	V
Emitter-Collector Voltage (Reverse Blocking)	V _{ECO}	6	V
Emitter-Base Voltage	V _{EBO}	7	V
Continuous Collector Current	I _C	0.5	A
Peak Pulse Current	I _{CM}	1	A
Base Current	I _B	0.2	A

Thermal Characteristics (@T_A = +25°C, unless otherwise specified.)

Characteristic	Symbol	Value	Unit	
Power Dissipation Linear Derating Factor	P _D	(Note 5)	0.84	W mW/°C
		(Note 6)	6.72	
		(Note 7)	1.34	
		(Note 8)	10.72	
		(Note 8)	1.5	
Thermal Resistance, Junction to Ambient	R _{θJA}	(Note 5)	12	°C/W
		(Note 6)	2	
		(Note 7)	16	
		(Note 8)	149	
Thermal Resistance, Junction to Lead	R _{θJL}	93.4	°C/W	
Operating and Storage Temperature Range	T _J , T _{STG}	(Note 9)	83.3	°C
			60	
			43.8	°C/W
			-55 to +150	°C

ESD Ratings (Note 10)

Characteristic	Symbol	Value	Unit	JEDEC Class
Electrostatic Discharge – Human Body Model	ESD HBM	4,000	V	3A
Electrostatic Discharge – Machine Model	ESD MM	400	V	C

- Notes:
5. For a device mounted with the exposed collector pad on 15mm x 15mm 1oz copper that is on a single-sided 1.6mm FR-4 PCB; device is measured under still air conditions whilst operating in a steady-state.
 6. Same as Note 5, except the device is mounted on 25mm x 25mm 2oz copper.
 7. Same as Note 5, except the device is mounted on 50mm x 50mm 2oz copper.
 8. Same as Note 7, whilst measured at t < 5 seconds.
 9. Thermal resistance from junction to solder-point (at the end of the collector lead).
 10. Refer to JEDEC specification JESD22-A114 and JESD22-A115.

Thermal Characteristics and Derating Information

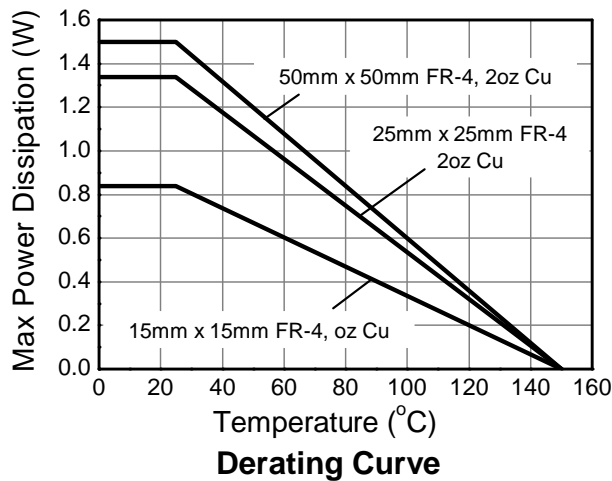
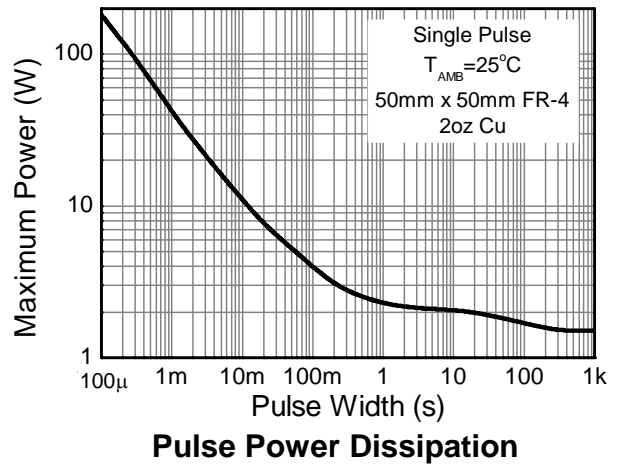
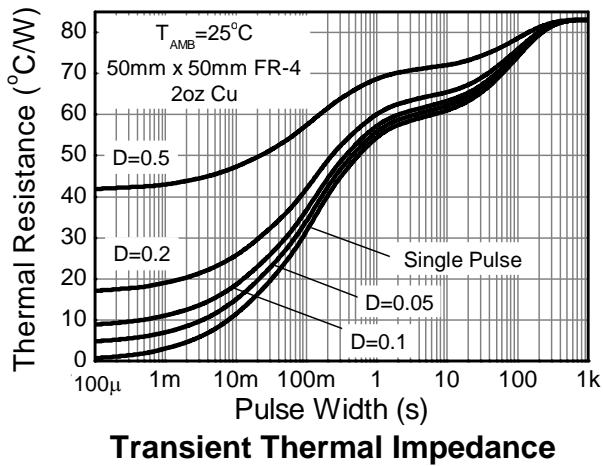
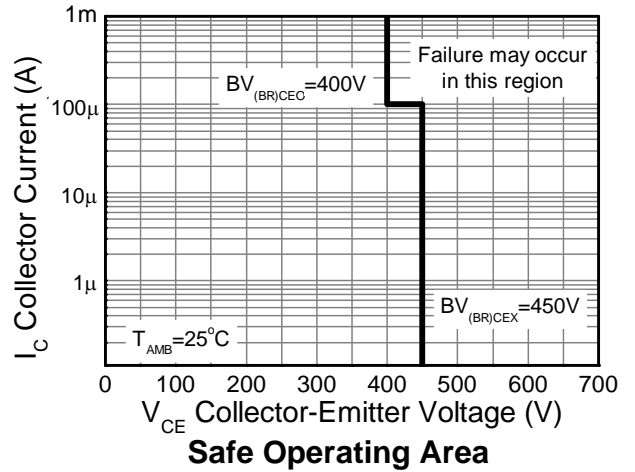
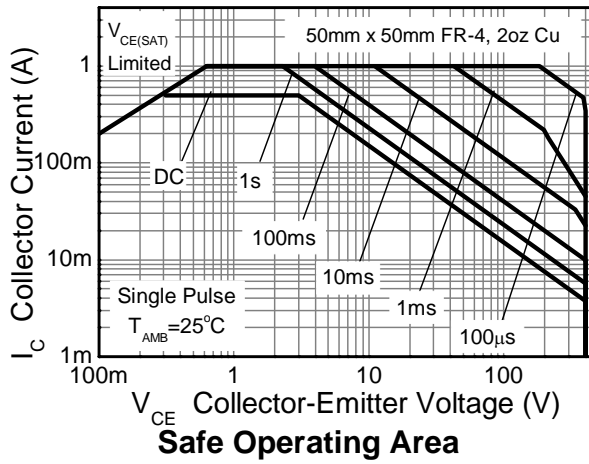

Electrical Characteristics (@ $T_A = +25^\circ\text{C}$, unless otherwise specified.)

Characteristic	Symbol	Min	Typ	Max	Unit	Test Condition
OFF CHARACTERISTICS						
Collector-Base Breakdown Voltage	BV_{CBO}	450	550	—	V	$I_C = 100\mu\text{A}$
Collector-Emitter Breakdown Voltage (Forward Blocking)	BV_{CEX}	450	550	—	V	$I_C = 100\mu\text{A}$, $R_{BE} \leq 1\text{k}\Omega$ or $-1\text{V} < V_{BE} < 0.25\text{V}$
Collector-Emitter Breakdown Voltage (Base Open) (Note 11)	BV_{CEO}	400	500	—	V	$I_C = 10\text{mA}$
Emitter-Base Breakdown Voltage	BV_{EBO}	7	8.1	—	V	$I_E = 100\mu\text{A}$
Emitter-Collector Breakdown Voltage (Reverse Blocking)	BV_{ECX}	6	8	—	V	$I_E = 100\mu\text{A}$, $R_{BC} \leq 1\text{k}\Omega$ or $-0.25\text{V} < V_{BC} < 0.25\text{V}$
Emitter-Collector Breakdown Voltage (Base Open)	BV_{ECO}	6	8.5	—	V	$I_E = 100\mu\text{A}$
Collector-Base Cutoff Current	I_{CBO}	—	<1	50	nA	$V_{CB} = 360\text{V}$
Collector-Emitter Cutoff Current	I_{CEX}	—	<1	100	nA	$V_{CE} = 360\text{V}$, $R_{BE} \leq 1\text{k}\Omega$ or $-1\text{V} < V_{BE} < 0.25\text{V}$
Emitter-Base Cutoff Current	I_{EBO}	—	<1	50	nA	$V_{EB} = 5.6\text{V}$
ON CHARACTERISTICS (Note 11)						
Static Forward Current Transfer Ratio	h_{FE}	90 100 10	165 180 20	300	—	$I_C = 1\text{mA}$, $V_{CE} = 5\text{V}$ $I_C = 50\text{mA}$, $V_{CE} = 5\text{V}$ $I_C = 500\text{mA}$, $V_{CE} = 5\text{V}$
Collector-Emitter Saturation Voltage	$V_{CE(SAT)}$	—	70 50 120 125	85 70 170 175	mV	$I_C = 20\text{mA}$, $I_B = 1\text{mA}$ $I_C = 50\text{mA}$, $I_B = 5\text{mA}$ $I_C = 300\text{mA}$, $I_B = 30\text{mA}$ $I_C = 500\text{mA}$, $I_B = 100\text{mA}$
Base-Emitter Saturation Voltage	$V_{BE(SAT)}$	—	865	950	mV	$I_C = 500\text{mA}$, $I_B = 100\text{mA}$
Base-Emitter On Voltage	$V_{BE(ON)}$	—	800	900	mV	$I_C = 500\text{mA}$, $V_{CE} = 10\text{V}$
SMALL SIGNAL CHARACTERISTICS (Note 11)						
Transition Frequency	f_T	—	40	—	MHz	$I_C = 10\text{mA}$, $V_{CE} = 20\text{V}$, $f = 20\text{MHz}$
Output Capacitance	C_{OBO}	—	8	10	pF	$V_{CB} = 20\text{V}$, $f = 1\text{MHz}$
Delay Time	t_D	—	100	—	ns	$V_{CC} = 100\text{V}$, $I_C = 100\text{mA}$, $I_{B1} = 10\text{mA}$, $I_{B2} = -20\text{mA}$
Rise Time	t_R	—	52	—	ns	
Storage Time	t_S	—	3122	—	ns	
Fall Time	t_F	—	240	—	ns	

Note: 11. Measured under pulsed conditions. Pulse width $\leq 300\mu\text{s}$. Duty cycle $\leq 2\%$.

Typical Electrical Characteristics (@ $T_A = +25^\circ\text{C}$, unless otherwise specified.)

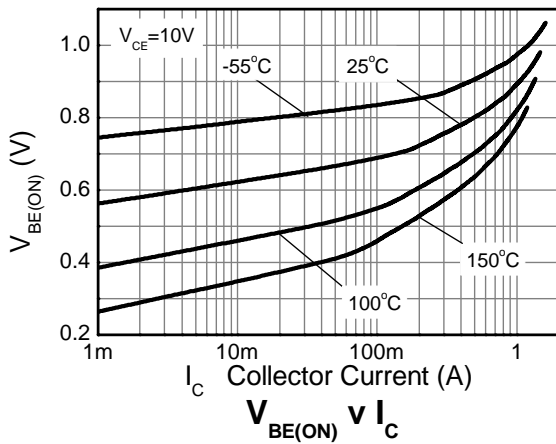
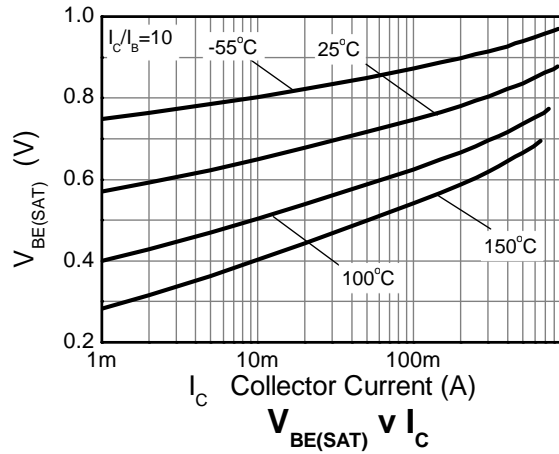
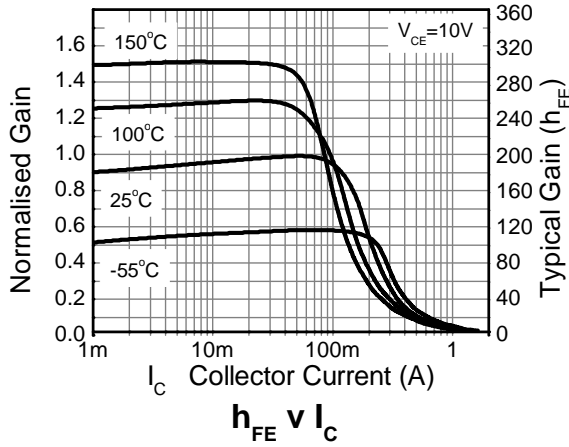
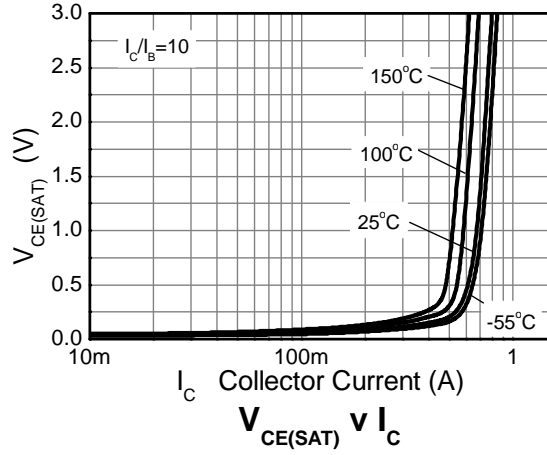
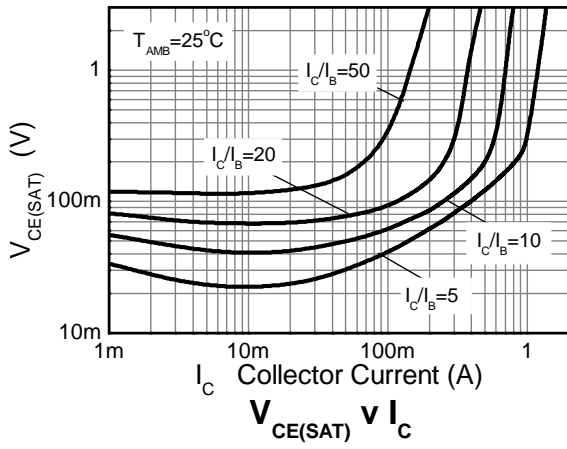

Package Outline Dimensions

Please see <http://www.diodes.com/package-outlines.html> for the latest version.

SOT23F

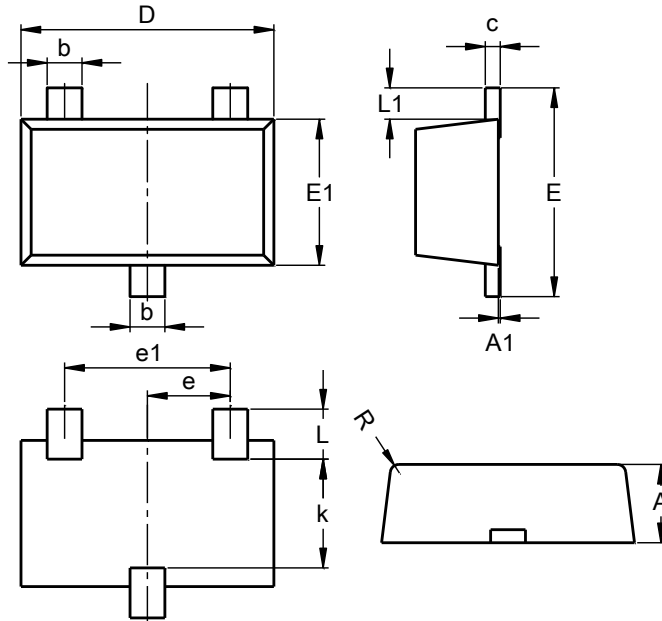

SOT23F			
Dim	Min	Max	Typ
A	0.80	1.00	0.90
A1	0.00	0.10	0.01
b	0.35	0.50	0.44
c	0.10	0.20	0.16
D	2.80	3.00	2.90
e	0.95 REF		
e1	1.90 REF		
E	2.30	2.50	2.40
E1	1.50	1.70	1.65
k	1.20	-	-
L	0.30	0.65	0.50
L1	0.30	0.50	0.40
R	0.05	0.15	-
All Dimensions in mm			

Suggested Pad Layout

Please see <http://www.diodes.com/package-outlines.html> for the latest version.

SOT23F

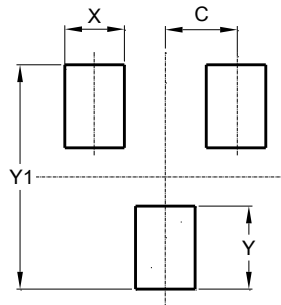

Dimensions	Value (in mm)
C	0.95
X	0.80
Y	1.110
Y1	3.000

IMPORTANT NOTICE

DIODES INCORPORATED MAKES NO WARRANTY OF ANY KIND, EXPRESS OR IMPLIED, WITH REGARDS TO THIS DOCUMENT, INCLUDING, BUT NOT LIMITED TO, THE IMPLIED WARRANTIES OF MERCHANTABILITY AND FITNESS FOR A PARTICULAR PURPOSE (AND THEIR EQUIVALENTS UNDER THE LAWS OF ANY JURISDICTION).

Diodes Incorporated and its subsidiaries reserve the right to make modifications, enhancements, improvements, corrections or other changes without further notice to this document and any product described herein. Diodes Incorporated does not assume any liability arising out of the application or use of this document or any product described herein; neither does Diodes Incorporated convey any license under its patent or trademark rights, nor the rights of others. Any Customer or user of this document or products described herein in such applications shall assume all risks of such use and will agree to hold Diodes Incorporated and all the companies whose products are represented on Diodes Incorporated website, harmless against all damages.

Diodes Incorporated does not warrant or accept any liability whatsoever in respect of any products purchased through unauthorized sales channel. Should Customers purchase or use Diodes Incorporated products for any unintended or unauthorized application, Customers shall indemnify and hold Diodes Incorporated and its representatives harmless against all claims, damages, expenses, and attorney fees arising out of, directly or indirectly, any claim of personal injury or death associated with such unintended or unauthorized application.

Products described herein may be covered by one or more United States, international or foreign patents pending. Product names and markings noted herein may also be covered by one or more United States, international or foreign trademarks.

This document is written in English but may be translated into multiple languages for reference. Only the English version of this document is the final and determinative format released by Diodes Incorporated.

LIFE SUPPORT

Diodes Incorporated products are specifically not authorized for use as critical components in life support devices or systems without the express written approval of the Chief Executive Officer of Diodes Incorporated. As used herein:

A. Life support devices or systems are devices or systems which:

1. are intended to implant into the body, or
2. support or sustain life and whose failure to perform when properly used in accordance with instructions for use provided in the labeling can be reasonably expected to result in significant injury to the user.

B. A critical component is any component in a life support device or system whose failure to perform can be reasonably expected to cause the failure of the life support device or to affect its safety or effectiveness.

Customers represent that they have all necessary expertise in the safety and regulatory ramifications of their life support devices or systems, and acknowledge and agree that they are solely responsible for all legal, regulatory and safety-related requirements concerning their products and any use of Diodes Incorporated products in such safety-critical, life support devices or systems, notwithstanding any devices- or systems-related information or support that may be provided by Diodes Incorporated. Further, Customers must fully indemnify Diodes Incorporated and its representatives against any damages arising out of the use of Diodes Incorporated products in such safety-critical, life support devices or systems.

Copyright © 2016, Diodes Incorporated

www.diodes.com

Looking for pricing, stock, or lifecycle information?

Click below to explore more details on WIN SOURCE:

 [View ZXTN08400BFFTA on WIN SOURCE](#)

 [Diodes Incorporated](#) Information

Optimize Your Supply Chain with WIN SOURCE Solutions

-  Global Sourcing Solution
-  Obsolete Management
-  Cost Control Management
-  Shortage Management
-  Alternative Solution
-  Excess Inventory Management