



**THE DATASHEET OF
AUIRF7304QTR**



Features

- Advanced Planar Technology
- Low On-Resistance
- Dual P Channel MOSFET
- Dynamic dv/dt Rating
- Logic Level
- 150°C Operating Temperature
- Fast Switching
- Lead-Free, RoHS Compliant
- Automotive Qualified *

HEXFET® Power MOSFET

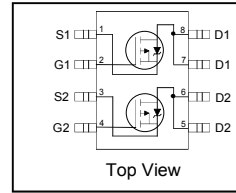

V_{DSS}		-20V
$R_{DS(on)}$ max.		0.090Ω
I_D		-4.3A

Description

Specifically designed for Automotive applications, this cellular design of HEXFET® Power MOSFETs utilizes the latest processing techniques to achieve low on-resistance per silicon area. This benefit combined with the fast switching speed and ruggedized device design that HEXFET power MOSFETs are well known for, provides the designer with an extremely efficient and reliable device for use in Automotive and a wide variety of other applications.



G	D	S
Gate	Drain	Source

Base part number	Package Type	Standard Pack		Orderable Part Number
		Form	Quantity	
AUIRF7304Q	SO-8	Tape and Reel	4000	AUIRF7304QTR

Absolute Maximum Ratings

Stresses beyond those listed under “Absolute Maximum Ratings” may cause permanent damage to the device. These are stress ratings only; and functional operation of the device at these or any other condition beyond those indicated in the specifications is not implied. Exposure to absolute-maximum-rated conditions for extended periods may affect device reliability. The thermal resistance and power dissipation ratings are measured under board mounted and still air conditions. Ambient temperature (TA) is 25°C, unless otherwise specified.

Symbol	Parameter	Max.	Units
$I_D @ T_A = 25^\circ C$	Continuous Drain Current, $V_{GS} @ -4.5V$	-4.7	A
$I_D @ T_A = 25^\circ C$	Continuous Drain Current, $V_{GS} @ -4.5V$	-4.3	
$I_D @ T_A = 70^\circ C$	Continuous Drain Current, $V_{GS} @ -4.5V$	-3.4	
I_{DM}	Pulsed Drain Current ①	-17	
$P_D @ T_A = 25^\circ C$	Maximum Power Dissipation ③	2.0	W
	Linear Derating Factor	0.016	W/°C
V_{GS}	Gate-to-Source Voltage	± 12	V
dv/dt	Peak Diode Recovery dv/dt ②	-5.0	V/ns
T_J T_{STG}	Operating Junction and Storage Temperature Range	-55 to + 150	°C

Thermal Resistance

Symbol	Parameter	Typ.	Max.	Units
$R_{\theta JA}$	Junction-to-Ambient ④	—	62.5	°C/W

HEXFET® is a registered trademark of Infineon.

*Qualification standards can be found at www.infineon.com

Static @ $T_J = 25^\circ\text{C}$ (unless otherwise specified)

	Parameter	Min.	Typ.	Max.	Units	Conditions
$V_{(BR)DSS}$	Drain-to-Source Breakdown Voltage	-20	—	—	V	$V_{GS} = 0V, I_D = -250\mu A$
$\Delta V_{(BR)DSS}/\Delta T_J$	Breakdown Voltage Temp. Coefficient	—	-0.012	—	V/ $^\circ\text{C}$	Reference to 25°C , $I_D = -1\text{mA}$
$R_{DS(on)}$	Static Drain-to-Source On-Resistance	—	—	0.090	Ω	$V_{GS} = -4.5V, I_D = -2.2A$ ③
		—	—	0.140		$V_{GS} = -2.7V, I_D = -1.8A$ ③
$V_{GS(th)}$	Gate Threshold Voltage	-0.70	—	-1.5	V	$V_{DS} = V_{GS}, I_D = -250\mu A$
g_{fs}	Forward Trans conductance	4.0	—	—	S	$V_{DS} = -16V, I_D = -2.2A$
I_{DSS}	Drain-to-Source Leakage Current	—	—	-1.0	μA	$V_{DS} = -16V, V_{GS} = 0V$
		—	—	-25		$V_{DS} = -16V, V_{GS} = 0V, T_J = 125^\circ\text{C}$
I_{GSS}	Gate-to-Source Forward Leakage	—	—	-100	nA	$V_{GS} = -12V$
	Gate-to-Source Reverse Leakage	—	—	100		$V_{GS} = 12V$

Dynamic Electrical Characteristics @ $T_J = 25^\circ\text{C}$ (unless otherwise specified)

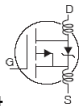
Q_g	Total Gate Charge	—	—	22	nC	$I_D = -2.2A$ $V_{DS} = -16V$ $V_{GS} = -4.5V$, See Fig.6 & 12 ③
Q_{gs}	Gate-to-Source Charge	—	—	3.3		
Q_{gd}	Gate-to-Drain Charge	—	—	9.0		
$t_{d(on)}$	Turn-On Delay Time	—	8.4	—	ns	$V_{DD} = -10V$ $I_D = -2.2A$ $R_G = 6.0\Omega$ $R_D = 4.5\Omega$, See Fig.10 ③
t_r	Rise Time	—	26	—		
$t_{d(off)}$	Turn-Off Delay Time	—	51	—		
t_f	Fall Time	—	33	—		
L_D	Internal Drain Inductance	—	4.0	—	nH	Between lead, 6mm (0.25in.) from package and center of die contact 
L_S	Internal Source Inductance	—	6.0	—		
C_{iss}	Input Capacitance	—	610	—	pF	$V_{GS} = 0V$ $V_{DS} = -15V$ $f = 1.0\text{MHz}$, See Fig.5
C_{oss}	Output Capacitance	—	310	—		
C_{rss}	Reverse Transfer Capacitance	—	170	—		

Diode Characteristics

	Parameter	Min.	Typ.	Max.	Units	Conditions
I_S	Continuous Source Current (Body Diode)	—	—	-2.5	A	MOSFET symbol showing the integral reverse p-n junction diode. 
	I_{SM}	Pulsed Source Current (Body Diode) ①	—	—		
V_{SD}	Diode Forward Voltage	—	—	-1.0	V	$T_J = 25^\circ\text{C}, I_S = -1.8A, V_{GS} = 0V$ ③
t_{rr}	Reverse Recovery Time	—	56	84	ns	$T_J = 25^\circ\text{C}, I_F = -2.2A$,
Q_{rr}	Reverse Recovery Charge	—	71	110	nC	$di/dt = 100A/\mu s$ ③
t_{on}	Forward Turn-On Time	Intrinsic turn-on time is negligible (turn-on is dominated by $L_S + L_D$)				

Notes:

- ① Repetitive rating; pulse width limited by max. junction temperature. (See Fig. 11)
- ② $I_{SD} \leq -2.2A$, $di/dt \leq 50A/\mu s$, $V_{DD} \leq V_{(BR)DSS}$, $T_J \leq 150^\circ\text{C}$.
- ③ Pulse width $\leq 300\mu s$; duty cycle $\leq 2\%$.
- ④ When mounted on 1 inch square copper board, $t \leq 10\text{sec}$.

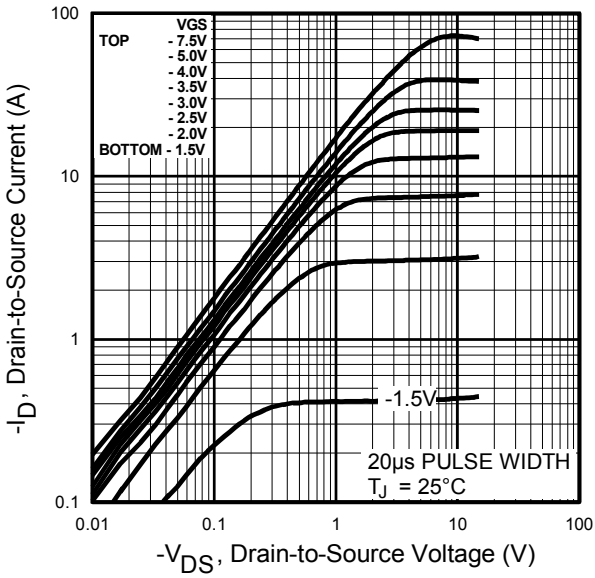
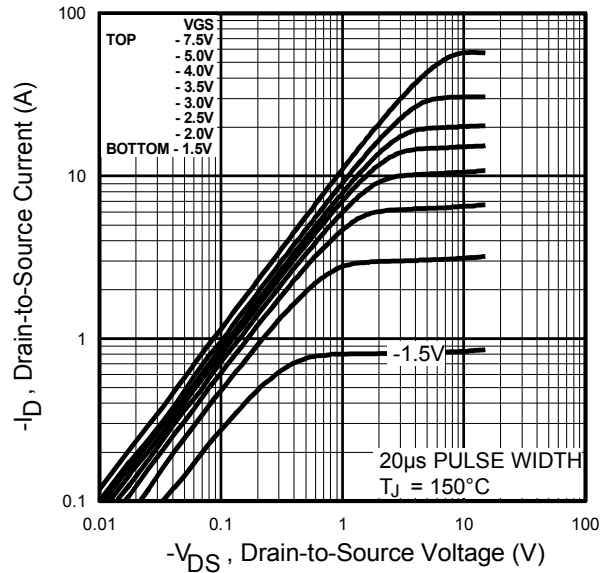
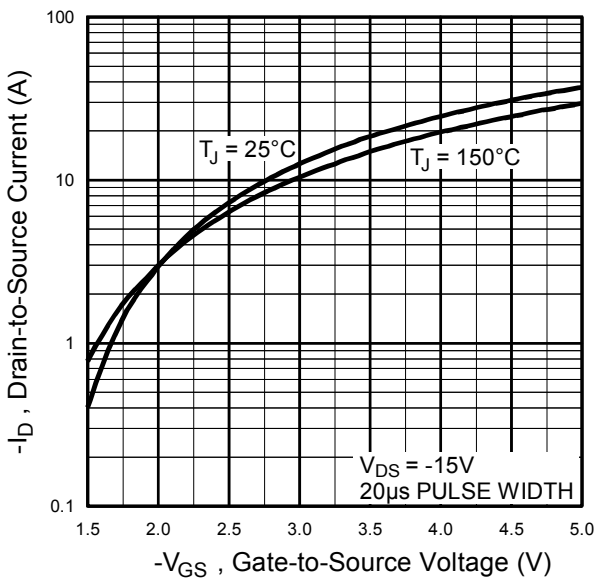
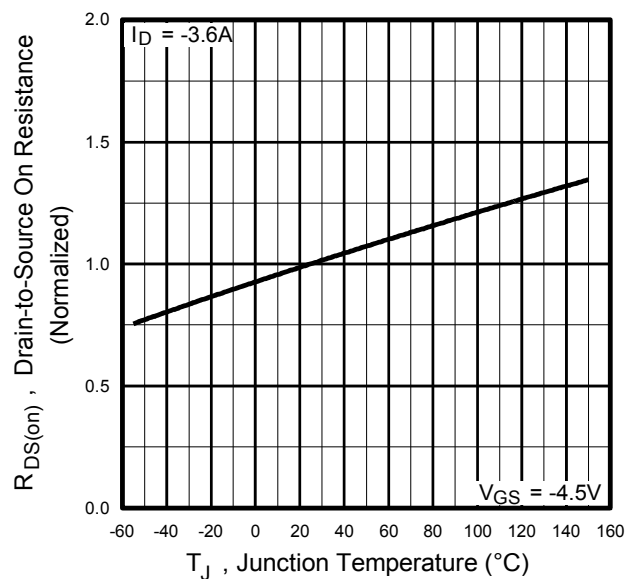
Fig. 1 Typical Output Characteristics

Fig. 2 Typical Output Characteristics

Fig. 3 Typical Transfer Characteristics

Fig. 4 Normalized On-Resistance Vs. Temperature

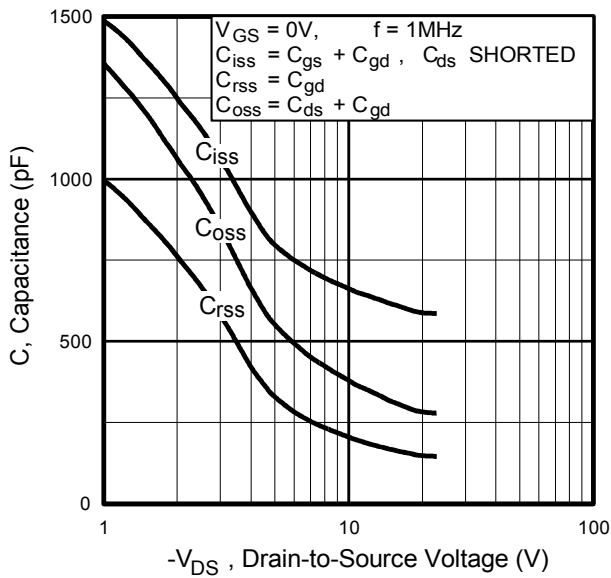

Fig 5. Typical Capacitance Vs. Drain-to-Source Voltage

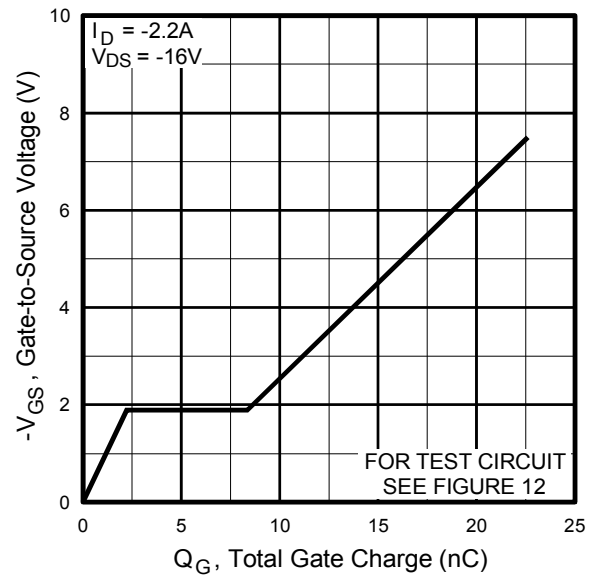

Fig 6. Typical Gate Charge Vs. Gate-to-Source Voltage

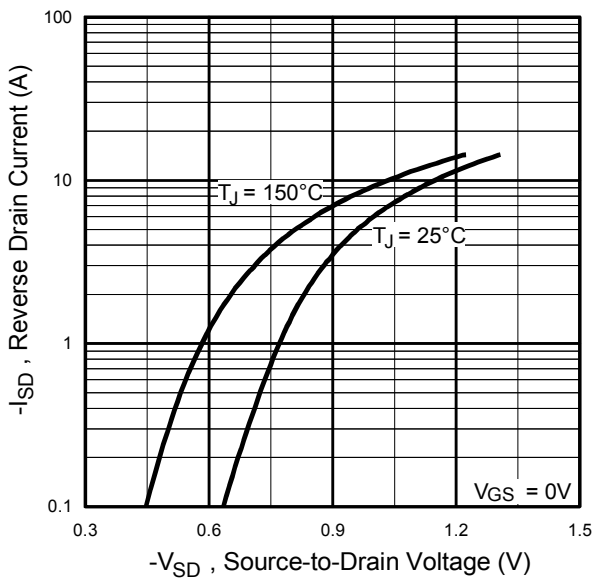

Fig. 7 Typical Source-Drain Diode Forward Voltage

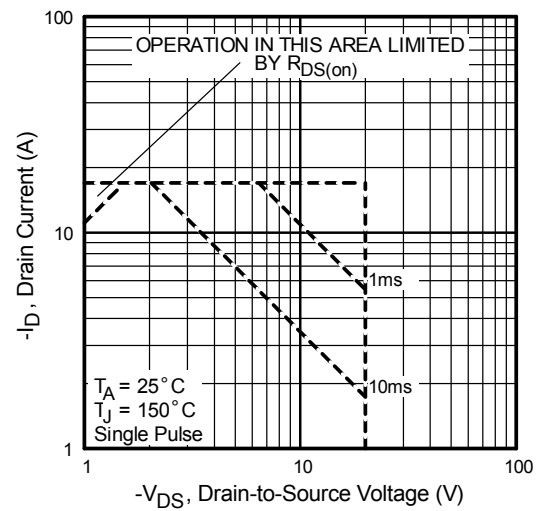

Fig 8. Maximum Safe Operating Area

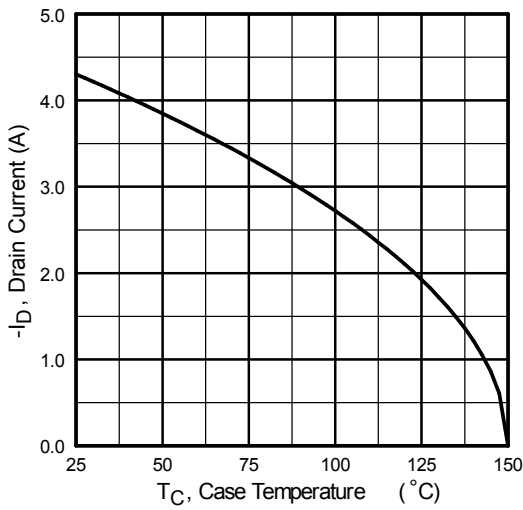

Fig 9. Maximum Drain Current Vs. Ambient Temperature

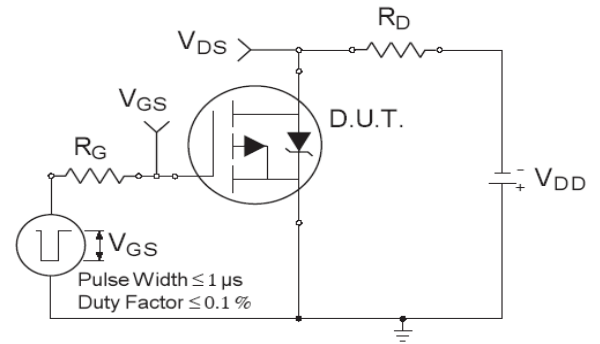

Fig 10a. Switching Time Test Circuit

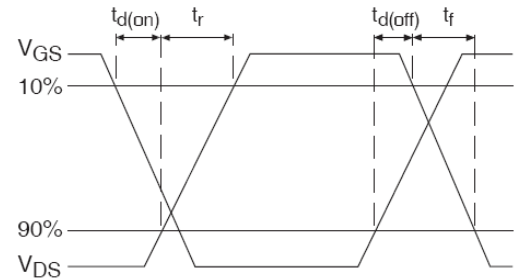

Fig 10b. Switching Time Waveforms

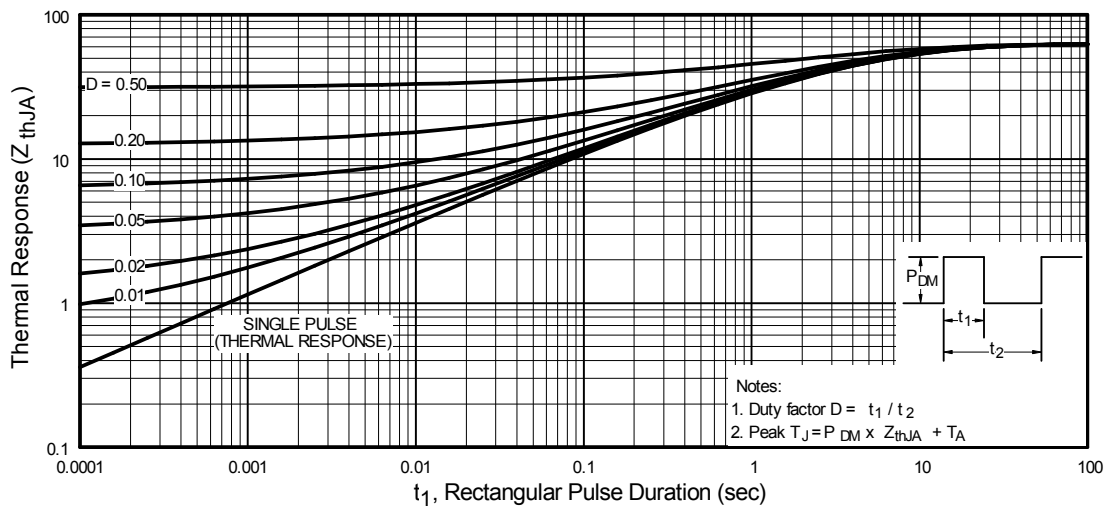
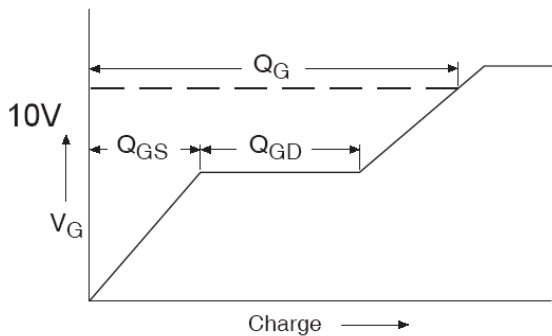
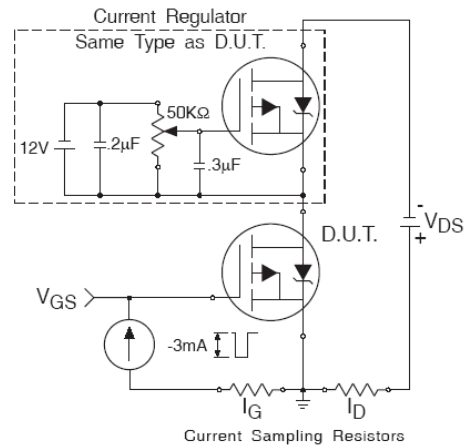
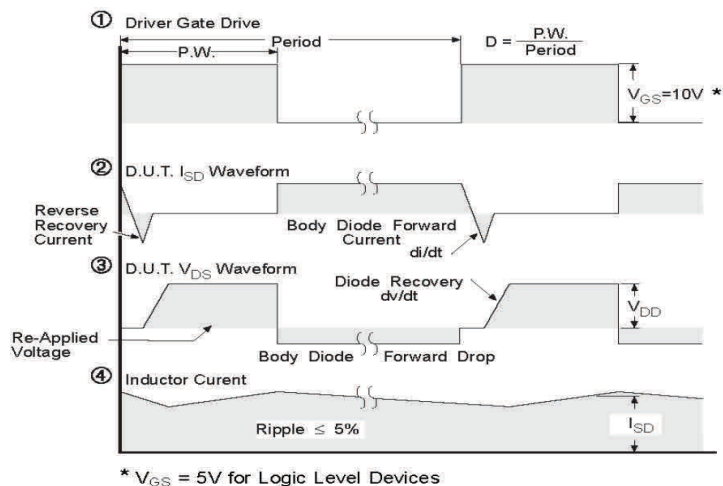
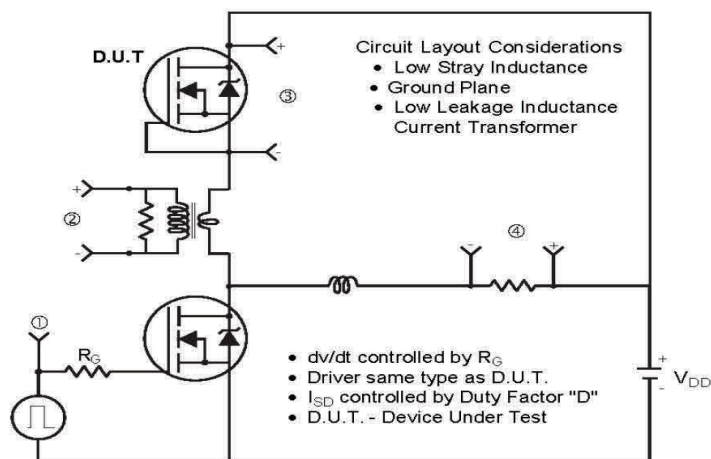

Fig 11. Maximum Effective Transient Thermal Impedance, Junction-to-Ambient

Fig 12a. Basic Gate Charge Waveform

Fig 12b. Gate Charge Test Circuit

Peak Diode Recovery dv/dt Test Circuit

Fig 13. Peak Diode Recovery dv/dt Test Circuit for P-Channel HEXFET® Power MOSFETs

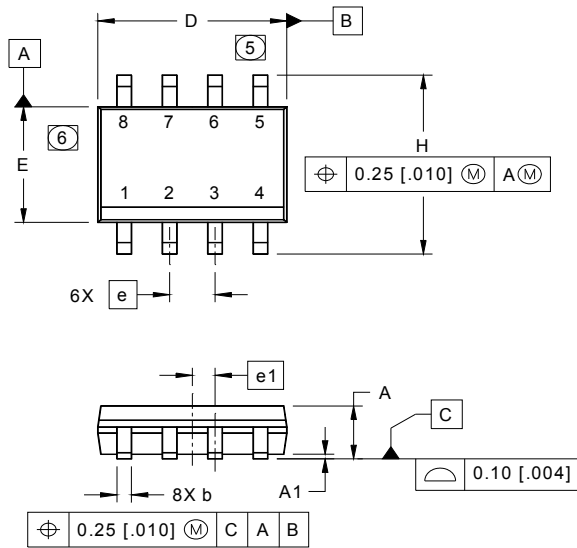
SO-8 Package Outline (Dimensions are shown in millimeters (inches))



DIM	INCHES		MILLIMETERS	
	MIN	MAX	MIN	MAX
A	.0532	.0688	1.35	1.75
A1	.0040	.0098	0.10	0.25
b	.013	.020	0.33	0.51
c	.0075	.0098	0.19	0.25
D	.189	.1968	4.80	5.00
E	.1497	.1574	3.80	4.00
e	.050 BASIC		1.27 BASIC	
e 1	.025 BASIC		0.635 BASIC	
H	.2284	.2440	5.80	6.20
K	.0099	.0196	0.25	0.50
L	.016	.050	0.40	1.27
y	0°	8°	0°	8°

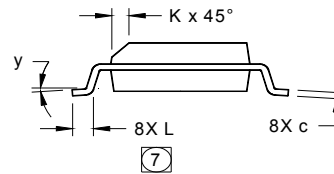

- NOTES:
1. DIMENSIONING & TOLERANCING PER ASME Y14.5M-1994.
 2. CONTROLLING DIMENSION: MILLIMETER
 3. DIMENSIONS ARE SHOWN IN MILLIMETERS [INCHES].
 4. OUTLINE CONFORMS TO JEDEC OUTLINE MS-012AA.
 5. DIMENSION DOES NOT INCLUDE MOLD PROTRUSIONS. MOLD PROTRUSIONS NOT TO EXCEED 0.15 [0.006].
 6. DIMENSION DOES NOT INCLUDE MOLD PROTRUSIONS. MOLD PROTRUSIONS NOT TO EXCEED 0.25 [0.010].
 7. DIMENSION IS THE LENGTH OF LEAD FOR SOLDERING TO A SUBSTRATE.

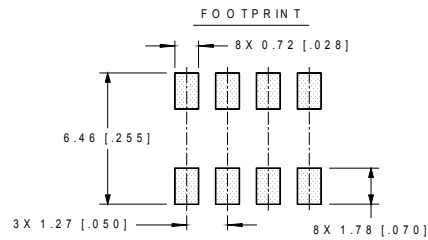

SO-8 Part Marking Information

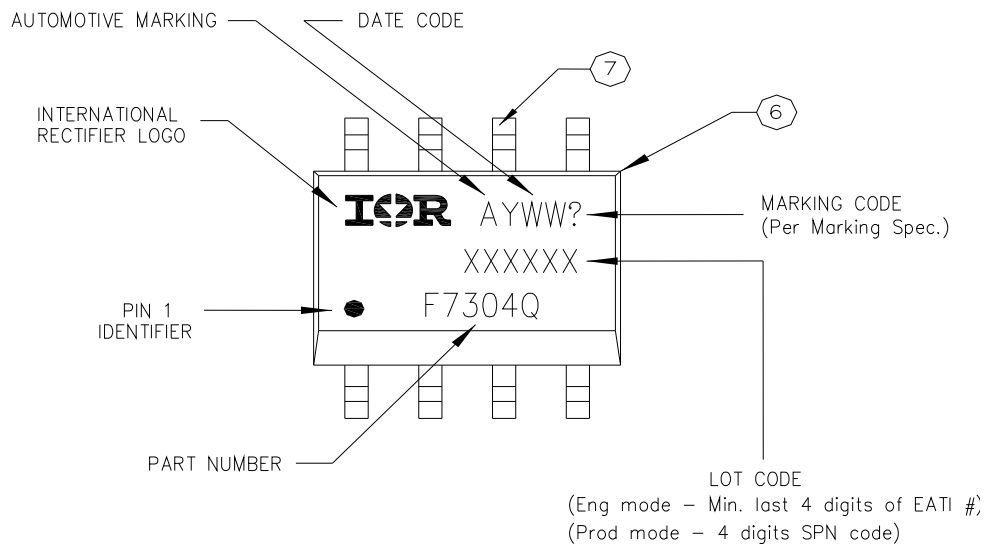

Note: For the most current drawing please refer to IR website at <http://www.irf.com/package/>

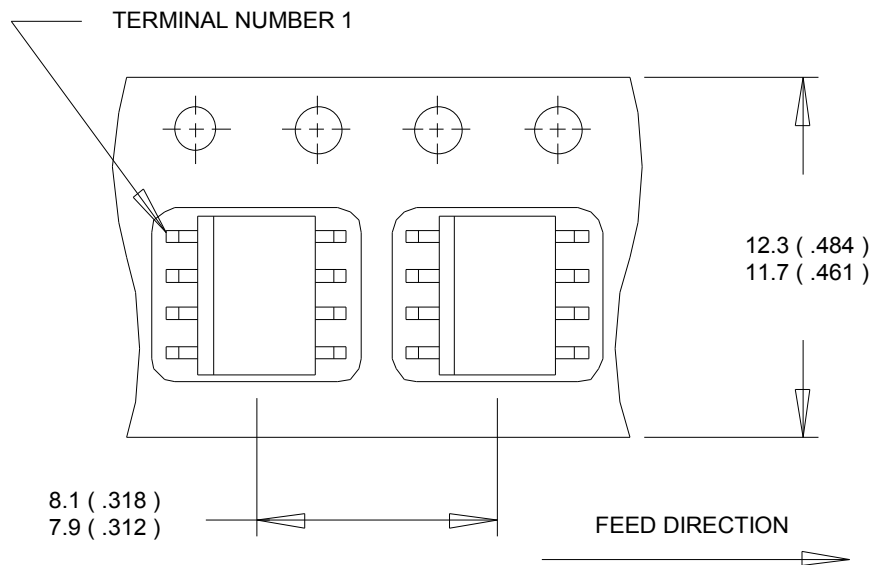
SO-8 Tape and Reel (Dimensions are shown in millimeters (inches))

NOTES:

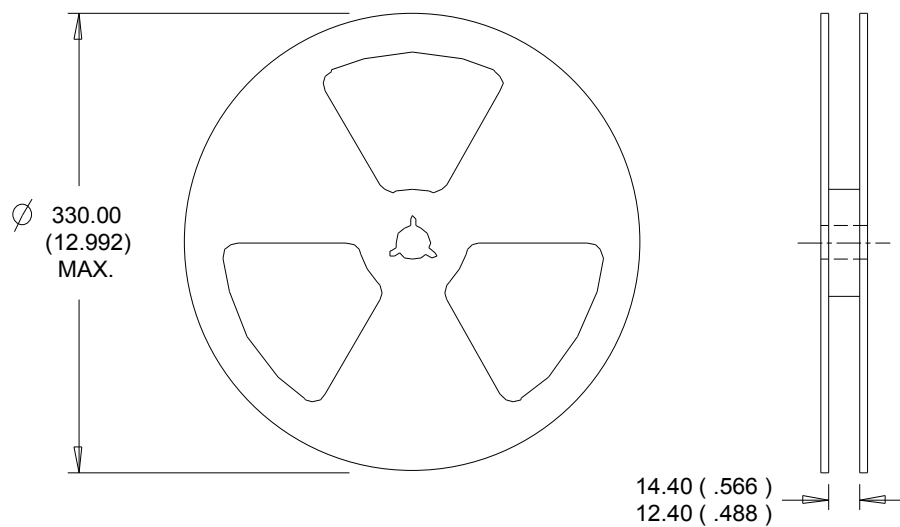
1. CONTROLLING DIMENSION : MILLIMETER.
2. ALL DIMENSIONS ARE SHOWN IN MILLIMETERS(INCHES).
3. OUTLINE CONFORMS TO EIA-481 & EIA-541.

NOTES :

1. CONTROLLING DIMENSION : MILLIMETER.
2. OUTLINE CONFORMS TO EIA-481 & EIA-541.

Note: For the most current drawing please refer to IR website at <http://www.irf.com/package/>

Qualification Information

Qualification Level		Automotive (per AEC-Q101)	
		Comments: This part number(s) passed Automotive qualification. Infineon's Industrial and Consumer qualification level is granted by extension of the higher Automotive level.	
Moisture Sensitivity Level		SO-8	MSL1
ESD	Machine Model	Class M1B (+/- 100V) [†] AEC-Q101-002	
	Human Body Model	Class H0 (+/- 250V) [†] AEC-Q101-001	
	Charged Device Model	Class C5 (+/- 2000V) [†] AEC-Q101-005	
RoHS Compliant		Yes	

† Highest passing voltage.

Revision History

Date	Comments
11/16/2015	<ul style="list-style-type: none"> Updated datasheet with corporate template Corrected ordering table on page 1.

Published by
Infineon Technologies AG
81726 München, Germany
 © Infineon Technologies AG 2015
All Rights Reserved.

IMPORTANT NOTICE

The information given in this document shall in no event be regarded as a guarantee of conditions or characteristics ("Beschaffenhheitsgarantie"). With respect to any examples, hints or any typical values stated herein and/or any information regarding the application of the product, Infineon Technologies hereby disclaims any and all warranties and liabilities of any kind, including without limitation warranties of non-infringement of intellectual property rights of any third party.

In addition, any information given in this document is subject to customer's compliance with its obligations stated in this document and any applicable legal requirements, norms and standards concerning customer's products and any use of the product of Infineon Technologies in customer's applications.

The data contained in this document is exclusively intended for technically trained staff. It is the responsibility of customer's technical departments to evaluate the suitability of the product for the intended application and the completeness of the product information given in this document with respect to such application.

For further information on the product, technology, delivery terms and conditions and prices please contact your nearest Infineon Technologies office (www.infineon.com).

WARNINGS

Due to technical requirements products may contain dangerous substances. For information on the types in question please contact your nearest Infineon Technologies office.

Except as otherwise explicitly approved by Infineon Technologies in a written document signed by authorized representatives of Infineon Technologies, Infineon Technologies' products may not be used in any applications where a failure of the product or any consequences of the use thereof can reasonably be expected to result in personal injury.

Looking for pricing, stock, or lifecycle information?

Click below to explore more details on WIN SOURCE:

 [View AUIRF7304QTR](#) on WIN SOURCE

 [Infineon Technologies](#) Information

Optimize Your Supply Chain with WIN SOURCE Solutions

-  Global Sourcing Solution
-  Obsolete Management
-  Cost Control Management
-  Shortage Management
-  Alternative Solution
-  Excess Inventory Management