



**THE DATASHEET OF
AOZ1038DI**



IR2184(4)(S) & (PbF)

HALF-BRIDGE DRIVER

Features

- Floating channel designed for bootstrap operation
Fully operational to +600V
Tolerant to negative transient voltage
dV/dt immune
- Gate drive supply range from 10 to 20V
- Undervoltage lockout for both channels
- 3.3V and 5V input logic compatible
- Matched propagation delay for both channels
- Logic and power ground +/- 5V offset.
- Lower di/dt gate driver for better noise immunity
- Output source/sink current capability 1.4A/1.8A
- Also available LEAD-FREE (PbF)

Packages

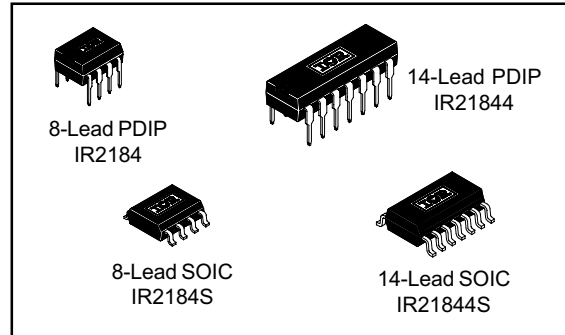

Description

The IR2184(4)(S) are high voltage, high speed power MOSFET and IGBT drivers with dependent high and low side referenced output channels. Proprietary HVIC and latch immune CMOS technologies enable ruggedized monolithic construction. The logic input is compatible with standard CMOS or LSTTL output, down to 3.3V logic. The output drivers feature a high pulse current buffer stage designed for minimum driver cross-conduction. The floating channel can be used to drive an N-channel power MOSFET or IGBT in the high side configuration which operates up to 600 volts.

IR2181/IR2183/IR2184 Feature Comparison

Part	Input logic	Cross-conduction prevention logic	Dead-Time	Ground Pins	Ton/Toff
2181 21814	HIN/LIN	no	none	COM VSS/COM	180/220 ns
2183 21834	HIN/LIN	yes	Internal 500ns Program 0.4 ~ 5 us	COM VSS/COM	180/220 ns
2184 21844	IN/SD	yes	Internal 500ns Program 0.4 ~ 5 us	COM VSS/COM	680/270 ns

Typical Connection

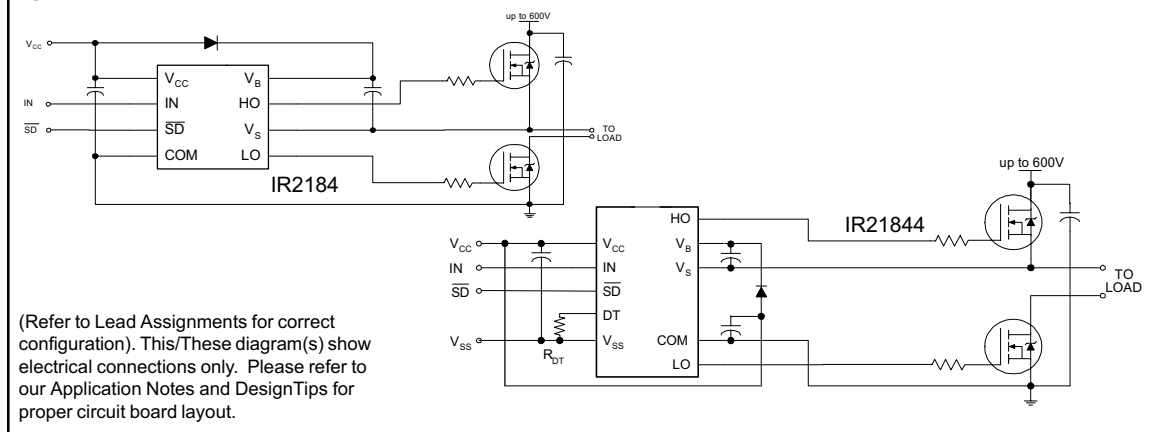

IR2184(4)(S) & (PbF)

Absolute Maximum Ratings

Absolute maximum ratings indicate sustained limits beyond which damage to the device may occur. All voltage parameters are absolute voltages referenced to COM. The thermal resistance and power dissipation ratings are measured under board mounted and still air conditions.

Symbol	Definition	Min.	Max.	Units	
V _B	High side floating absolute voltage	-0.3	625	V	
V _S	High side floating supply offset voltage	V _B - 25	V _B + 0.3		
V _{HO}	High side floating output voltage	V _S - 0.3	V _B + 0.3		
V _{CC}	Low side and logic fixed supply voltage	-0.3	25		
V _{LO}	Low side output voltage	-0.3	V _{CC} + 0.3		
DT	Programmable dead-time pin voltage (IR21844 only)	V _{SS} - 0.3	V _{CC} + 0.3		
V _{IN}	Logic input voltage (IN & \overline{SD})	V _{SS} - 0.3	V _{SS} + 5		
V _{SS}	Logic ground (IR21844 only)	V _{CC} - 25	V _{CC} + 0.3		
dV _S /dt	Allowable offset supply voltage transient	—	50	V/ns	
P _D	Package power dissipation @ T _A ≤ +25°C	(8-lead PDIP)	—	1.0	W
		(8-lead SOIC)	—	0.625	
		(14-lead PDIP)	—	1.6	
		(14-lead SOIC)	—	1.0	
R _{thJA}	Thermal resistance, junction to ambient	(8-lead PDIP)	—	125	°C/W
		(8-lead SOIC)	—	200	
		(14-lead PDIP)	—	75	
		(14-lead SOIC)	—	120	
T _J	Junction temperature	—	150	°C	
T _S	Storage temperature	-50	150		
T _L	Lead temperature (soldering, 10 seconds)	—	300		

Recommended Operating Conditions

The input/output logic timing diagram is shown in figure 1. For proper operation the device should be used within the recommended conditions. The V_S and V_{SS} offset rating are tested with all supplies biased at 15V differential.

Symbol	Definition	Min.	Max.	Units
V _B	High side floating supply absolute voltage	V _S + 10	V _S + 20	V
V _S	High side floating supply offset voltage	Note 1	600	
V _{HO}	High side floating output voltage	V _S	V _B	
V _{CC}	Low side and logic fixed supply voltage	10	20	
V _{LO}	Low side output voltage	0	V _{CC}	
V _{IN}	Logic input voltage (IN & \overline{SD})	V _{SS}	V _{SS} + 4	
DT	Programmable dead-time pin voltage (IR21844 only)	V _{SS}	V _{CC}	
V _{SS}	Logic ground (IR21844 only)	-5	5	
T _A	Ambient temperature	-40	125	°C

Note 1: Logic operational for V_S of -5V to +600V. Logic state held for V_S of -5V to -V_{BS}. (Please refer to the Design Tip DT97-3 for more details).

Note 2: IN and SD are internally clamped with a 5.2V zener diode.

Dynamic Electrical Characteristics

$V_{BIAS} (V_{CC}, V_{BS}) = 15V$, $V_{SS} = COM$, $C_L = 1000 pF$, $T_A = 25^\circ C$, $DT = V_{SS}$ unless otherwise specified.

Symbol	Definition	Min.	Typ.	Max.	Units	Test Conditions
t_{on}	Turn-on propagation delay	—	680	900	nsec	$V_S = 0V$
t_{off}	Turn-off propagation delay	—	270	400		$V_S = 0V$ or $600V$
t_{sd}	Shut-down propagation delay	—	180	270		
M T_{on}	Delay matching, HS & LS turn-on	—	0	90		
M T_{off}	Delay matching, HS & LS turn-off	—	0	40		
t_r	Turn-on rise time	—	40	60		$V_S = 0V$
t_f	Turn-off fall time	—	20	35		$V_S = 0V$
DT	Deadtime: LO turn-off to HO turn-on(DT _{LO-HO}) & HO turn-off to LO turn-on (DT _{HO-LO})	280	400	520	μsec	RDT= 0
		4	5	6		RDT = 200k
MDT	Deadtime matching = DT _{LO} - HO - DT _{HO-LO}	—	0	50	nsec	RDT=0
		—	0	600		RDT = 200k

Static Electrical Characteristics

$V_{BIAS} (V_{CC}, V_{BS}) = 15V$, $V_{SS} = COM$, $DT = V_{SS}$ and $T_A = 25^\circ C$ unless otherwise specified. The V_{IL} , V_{IH} and I_{IN} parameters are referenced to V_{SS} / COM and are applicable to the respective input leads: IN and \overline{SD} . The V_O , I_O and R_{on} parameters are referenced to COM and are applicable to the respective output leads: HO and LO.

Symbol	Definition	Min.	Typ.	Max.	Units	Test Conditions
V_{IH}	Logic "1" input voltage for HO & logic "0" for LO	2.7	—	—	V	$V_{CC} = 10V$ to $20V$
V_{IL}	Logic "0" input voltage for HO & logic "1" for LO	—	—	0.8		$V_{CC} = 10V$ to $20V$
$V_{SD,TH+}$	\overline{SD} input positive going threshold	2.7	—	—		$V_{CC} = 10V$ to $20V$
$V_{SD,TH-}$	\overline{SD} input negative going threshold	—	—	0.8		$V_{CC} = 10V$ to $20V$
V_{OH}	High level output voltage, $V_{BIAS} - V_O$	—	—	1.2		$I_O = 0A$
V_{OL}	Low level output voltage, V_O	—	—	0.1		$I_O = 0A$
I_{LK}	Offset supply leakage current	—	—	50	μA	$V_B = V_S = 600V$
I_{QBS}	Quiescent V_{BS} supply current	20	60	150		$V_{IN} = 0V$ or $5V$
I_{QCC}	Quiescent V_{CC} supply current	0.4	1.0	1.6	mA	$V_{IN} = 0V$ or $5V$
I_{IN+}	Logic "1" input bias current	—	25	60	μA	$I_N = 5V$, $\overline{SD} = 0V$
I_{IN-}	Logic "0" input bias current	—	—	1.0		$I_N = 0V$, $\overline{SD} = 5V$
V_{CCUV+} V_{BSUV+}	V_{CC} and V_{BS} supply undervoltage positive going threshold	8.0	8.9	9.8	V	
V_{CCUV-} V_{BSUV-}	V_{CC} and V_{BS} supply undervoltage negative going threshold	7.4	8.2	9.0		
V_{CCUVH} V_{BSUVH}	Hysteresis	0.3	0.7	—		
I_{O+}	Output high short circuit pulsed current	1.4	1.9	—	A	$V_O = 0V$, $PW \leq 10 \mu s$
I_{O-}	Output low short circuit pulsed current	1.8	2.3	—		$V_O = 15V$, $PW \leq 10 \mu s$

IR2184(4)(S)&(PbF)

Functional Block Diagrams

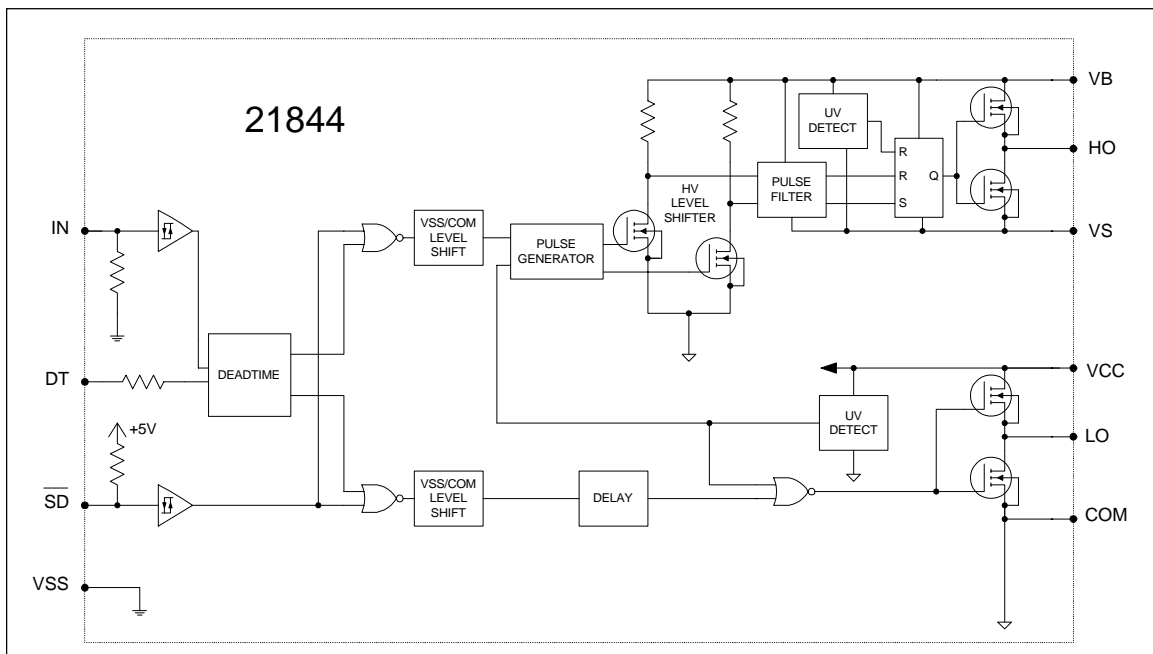
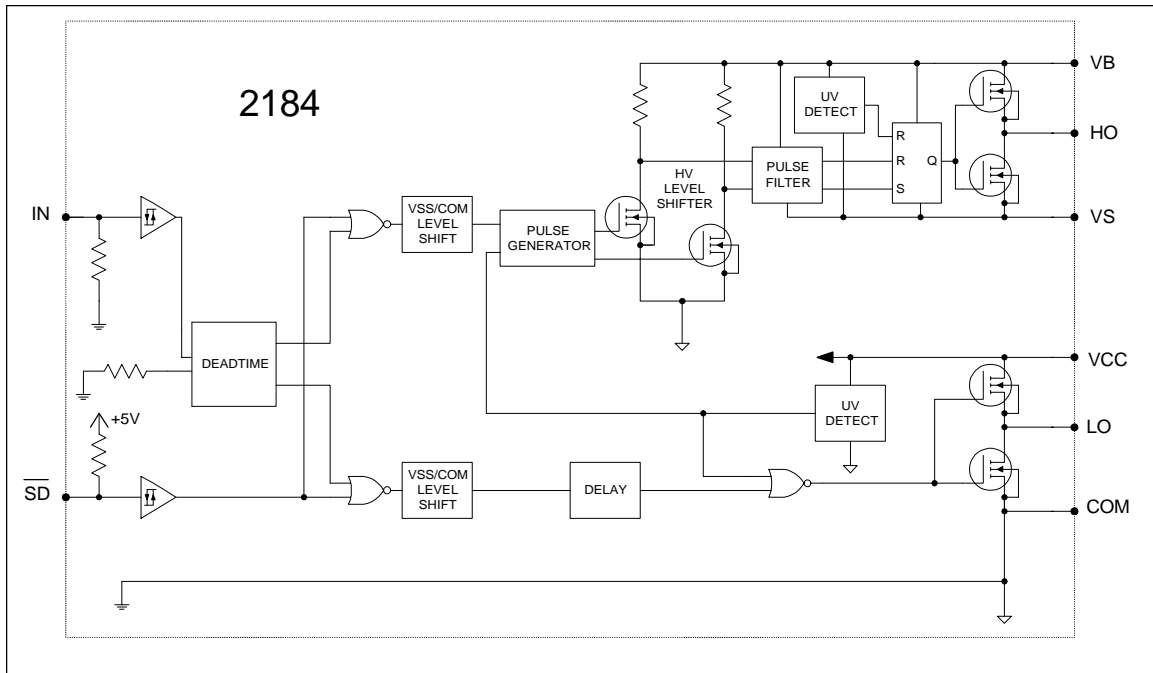

Lead Definitions

Symbol	Description
IN	Logic input for high and low side gate driver outputs (HO and LO), in phase with HO (referenced to COM for IR2184 and VSS for IR21844)
\overline{SD}	Logic input for shutdown (referenced to COM for IR2184 and VSS for IR21844)
DT	Programmable dead-time lead, referenced to VSS. (IR21844 only)
VSS	Logic Ground (21844 only)
V_B	High side floating supply
HO	High side gate drive output
V_S	High side floating supply return
V_{CC}	Low side and logic fixed supply
LO	Low side gate drive output
COM	Low side return

Lead Assignments

<p>8-Lead PDIP</p>	<p>8-Lead SOIC</p>
IR2184	IR2184S
<p>14-Lead PDIP</p>	<p>14-Lead SOIC</p>
IR21844	IR21844S

IR2184(4)(S)&(PbF)

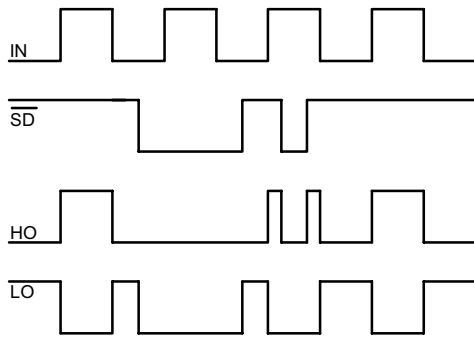

Figure 1. Input/Output Timing Diagram

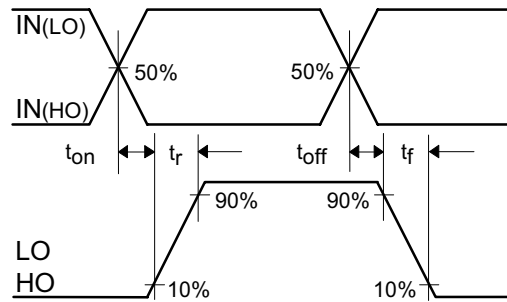

Figure 2. Switching Time Waveform Definitions

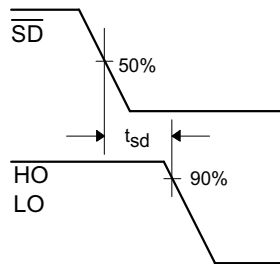

Figure 3. Shutdown Waveform Definitions

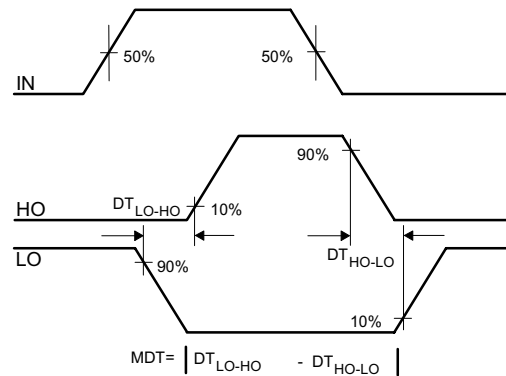

Figure 4. Deadtime Waveform Definitions

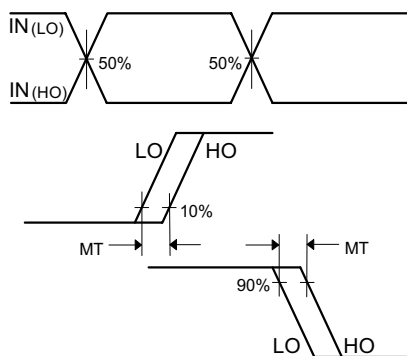

Figure 5. Delay Matching Waveform Definitions

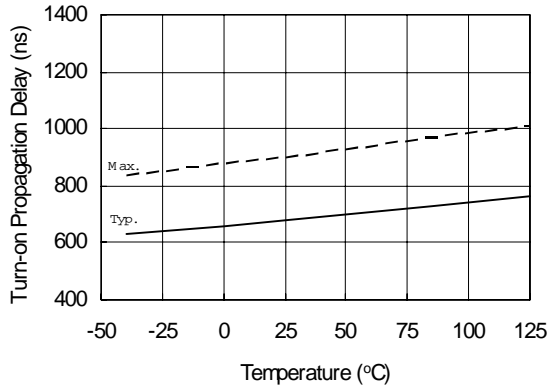

Figure 4A. Turn-on Propagation Delay vs. Temperature

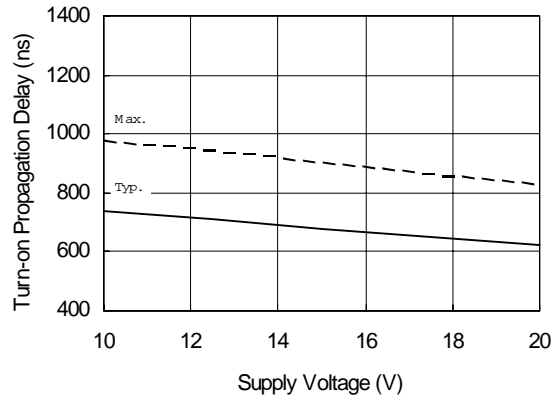

Figure 4B. Turn-on Propagation Delay vs. Supply Voltage

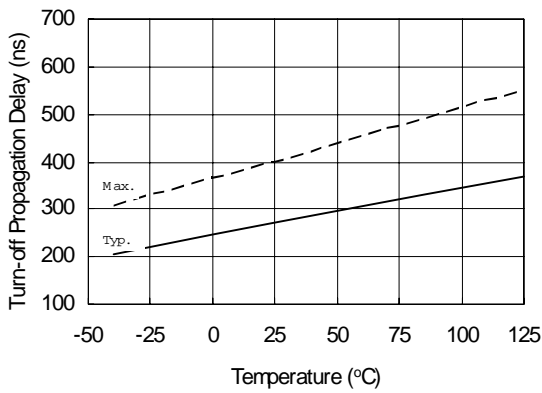

Figure 5A. Turn-off Propagation Delay vs. Temperature

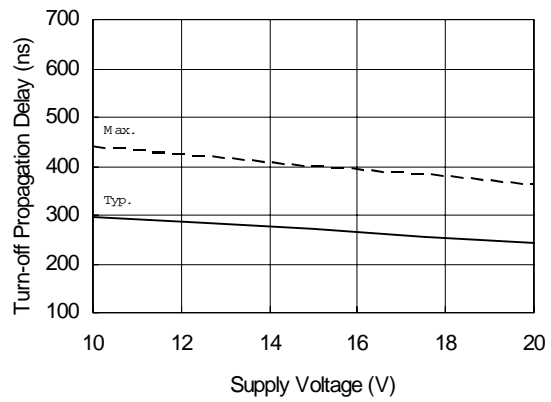

Figure 5B. Turn-off Propagation Delay vs. Supply Voltage

IR2184(4)(S)&(PbF)

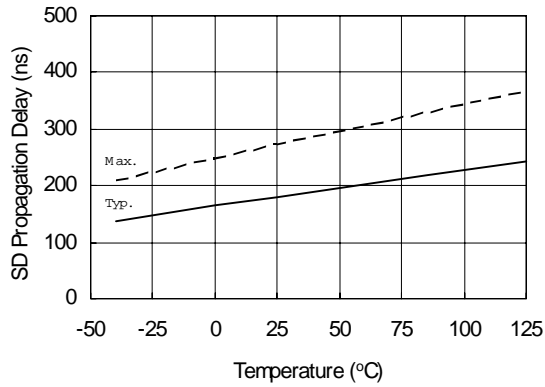

Figure 6A. SD Propagation Delay vs. Temperature

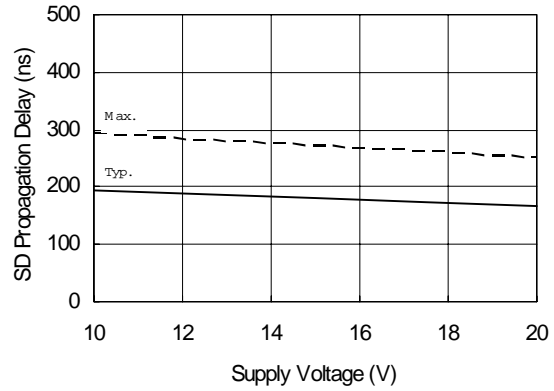

Figure 6B. SD Propagation Delay vs. Supply Voltage

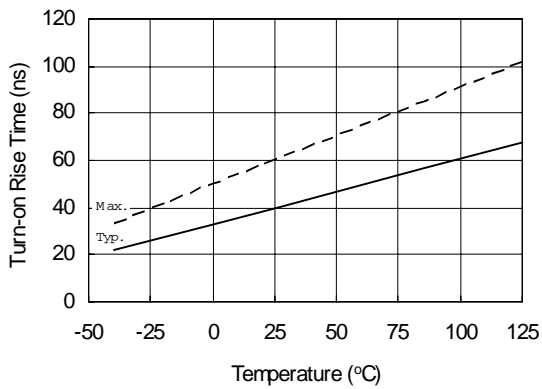

Figure 7A. Turn-on Rise Time vs. Temperature

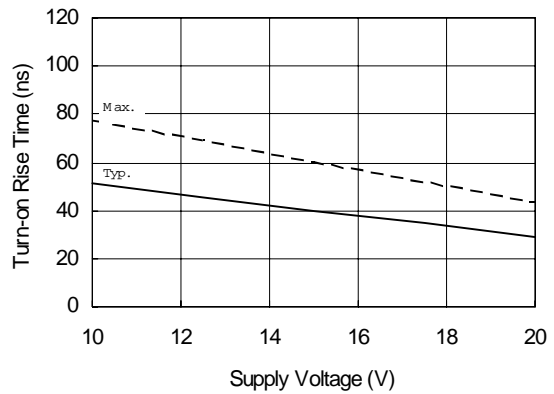

Figure 7B. Turn-on Rise Time vs. Supply Voltage

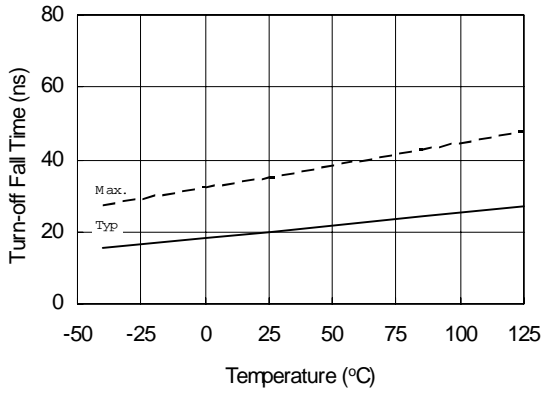

Figure 8A. Turn-off Fall Time vs. Temperature

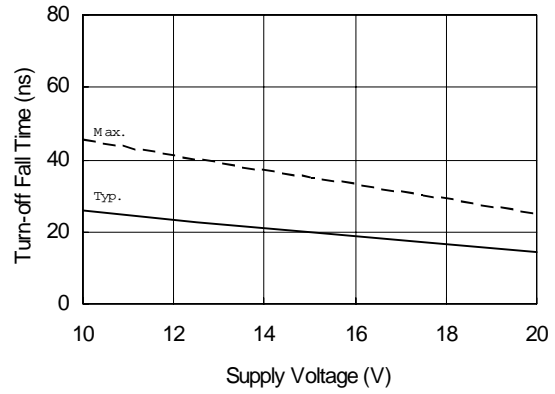

Figure 8B. Turn-off Fall Time vs. Supply Voltage

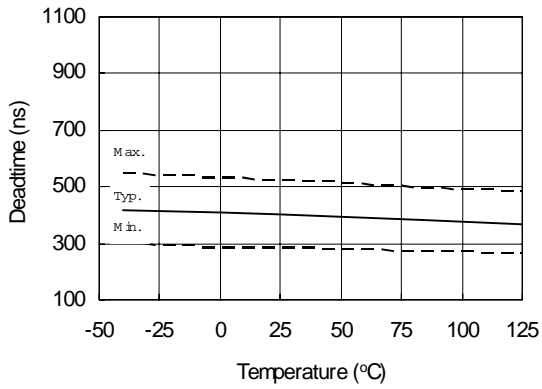

Figure 9A. Deadtime vs. Temperature

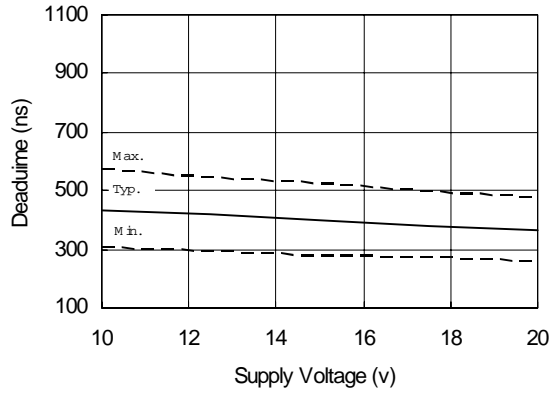

Figure 9B. Deadtime vs. Supply Voltage

IR2184(4)(S)&(PbF)

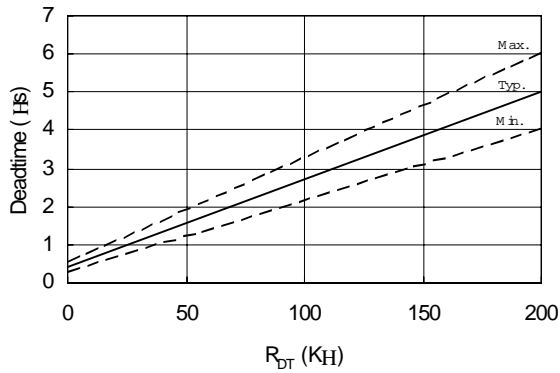

Figure 9C. Deadtime vs. R_{DT}

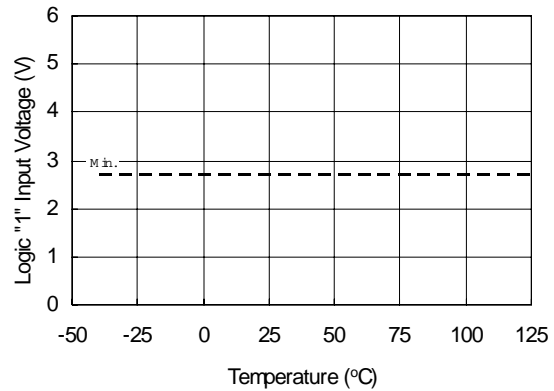

Figure 10A. Logic "1" Input Voltage vs. Temperature

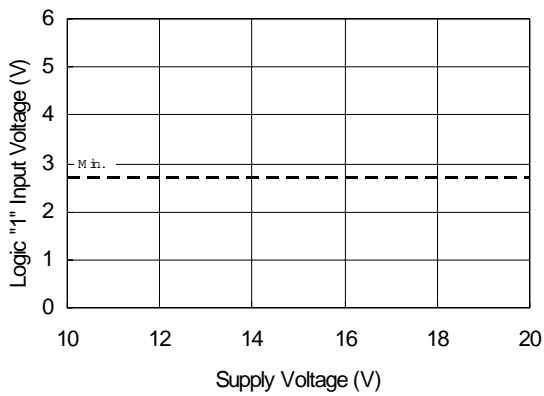

Figure 10B. Logic "1" Input Voltage vs. Supply Voltage

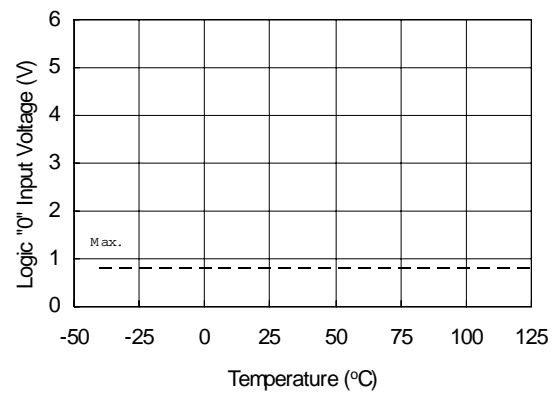

Figure 11A. Logic "0" Input Voltage vs. Temperature

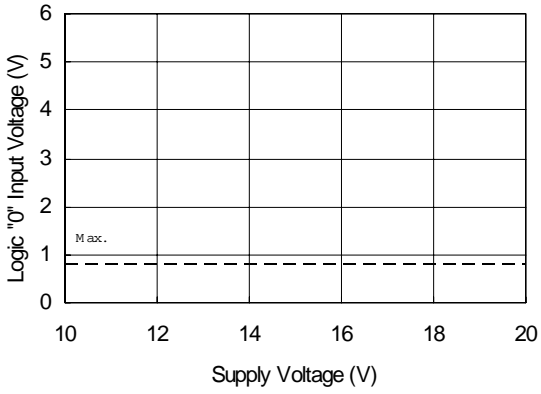

Figure 11B. Logic "0" Input Voltage vs. Supply Voltage

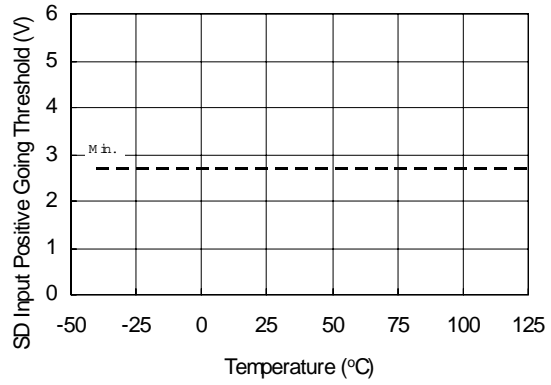

Figure 12A. SD Input Positive Going Threshold vs. Temperature

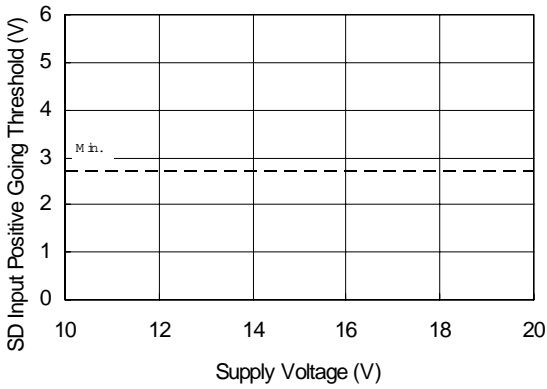

Figure 12B. SD Input Positive Going Threshold vs. Supply Voltage

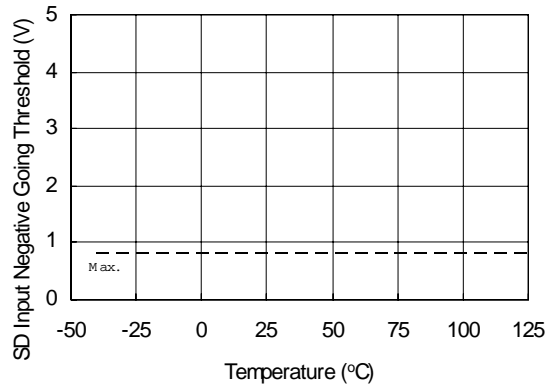

Figure 13A. SD Input Negative Going Threshold vs. Temperature

IR2184(4)(S)&(PbF)

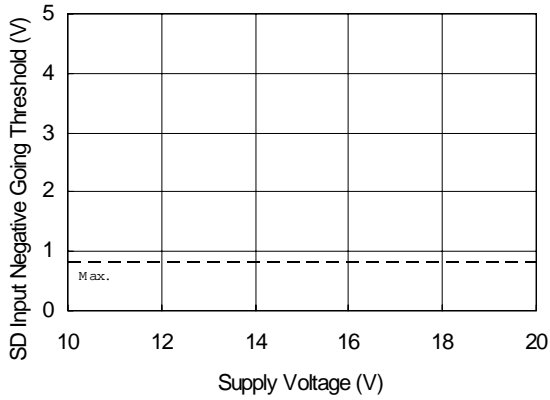

Figure 13B. SD Input Negative Going Threshold vs. Supply Voltage

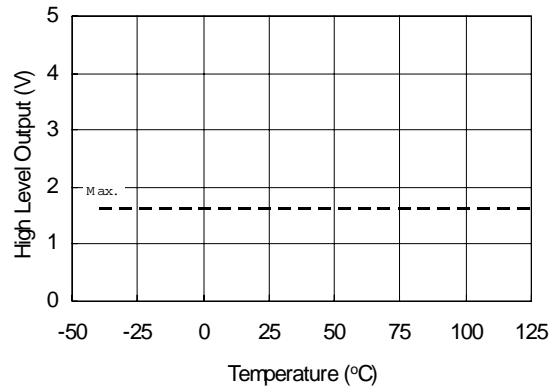

Figure 14A. High Level Output vs. Temperature

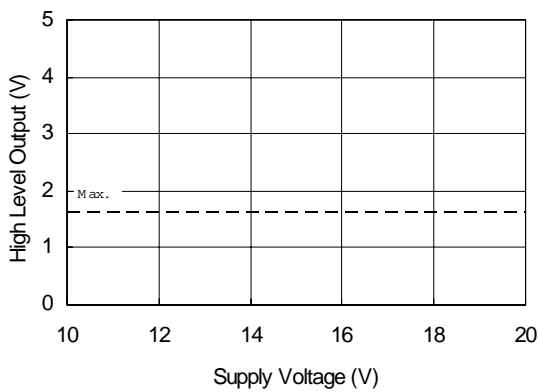

Figure 14B. High Level Output vs. Supply Voltage

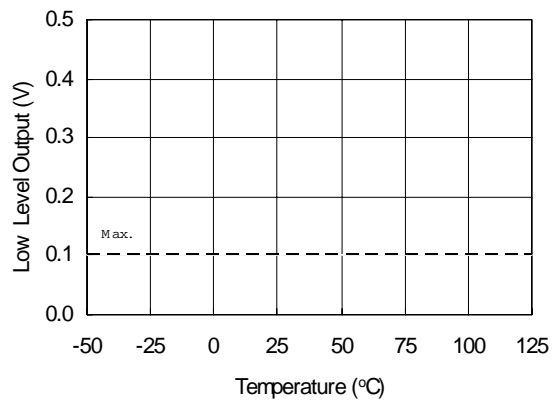

Figure 15A. Low Level Output vs. Temperature

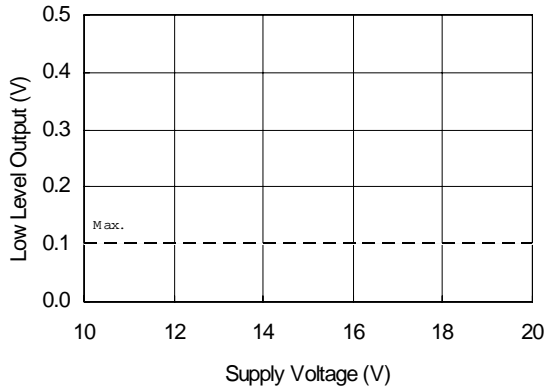

Figure 15B. Low Level Output vs. Supply Voltage

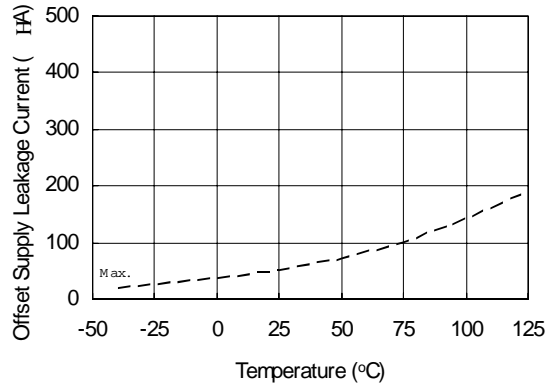

Figure 16A. Offset Supply Leakage Current vs. Temperature

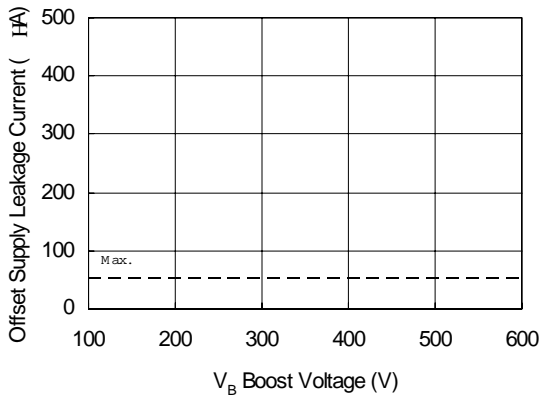

Figure 16B. Offset Supply Leakage Current vs. V_B Boost Voltage

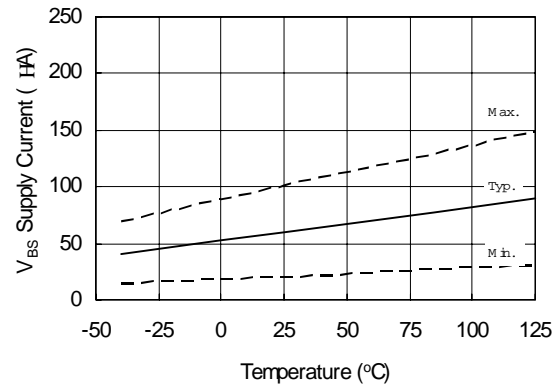

Figure 17A. V_{BS} Supply Current vs. Temperature

IR2184(4)(S)&(PbF)

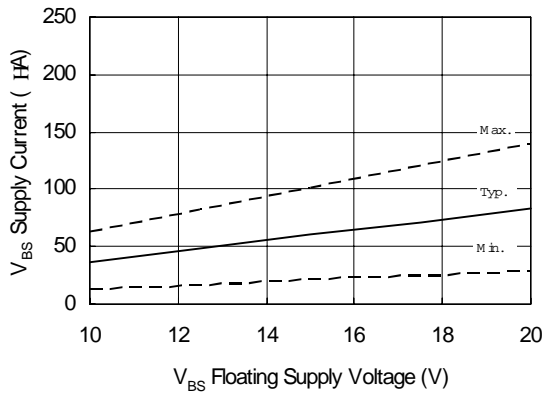

Figure 17B. V_{BS} Supply Current vs. V_{BS} Floating Supply Voltage

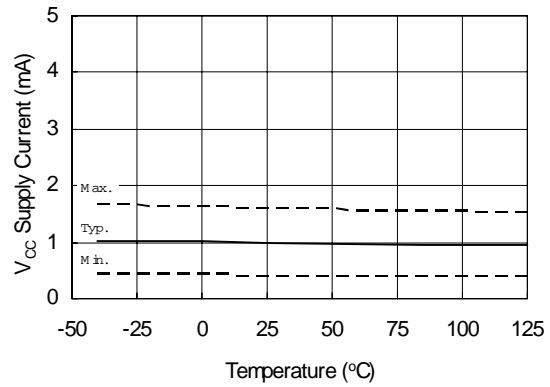

Figure 18A. V_{CC} Supply Current vs. Temperature

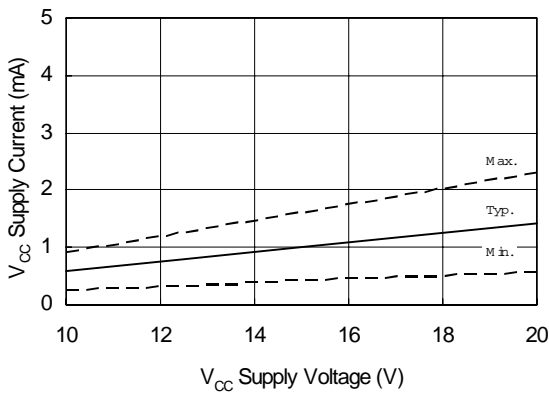

Figure 18B. V_{CC} Supply Current vs. V_{CC} Supply Voltage

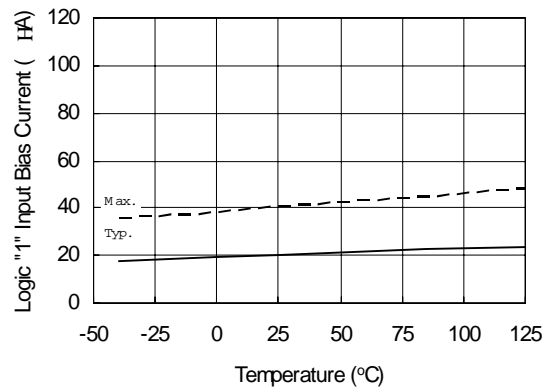

Figure 19A. Logic "1" Input Bias Current vs. Temperature

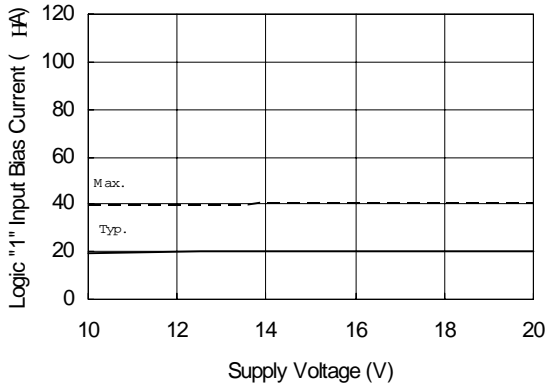

Figure 19B. Logic "1" Input Bias Current vs. Supply Voltage

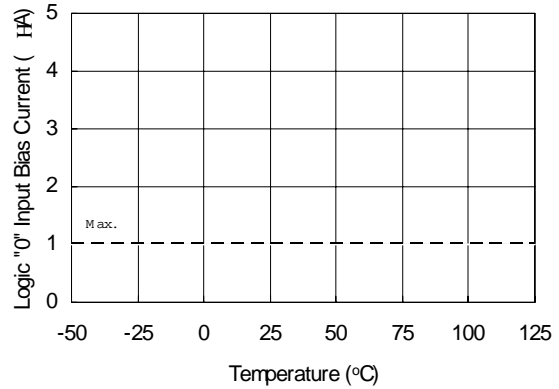

Figure 20A. Logic "0" Input Bias Current vs. Temperature

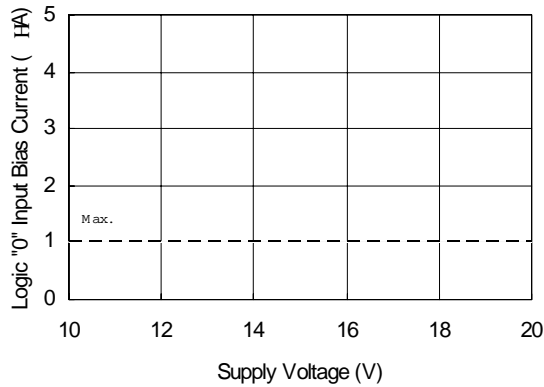

Figure 20B. Logic "0" Input Bias Current vs. Supply Voltage

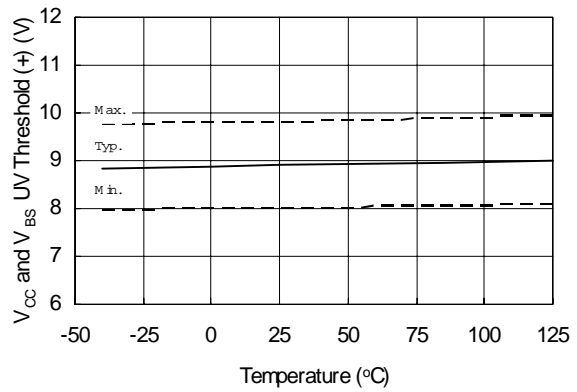

Figure 21. V_{CC} and V_{BS} Undervoltage Threshold (+) vs. Temperature

IR2184(4)(S)&(PbF)

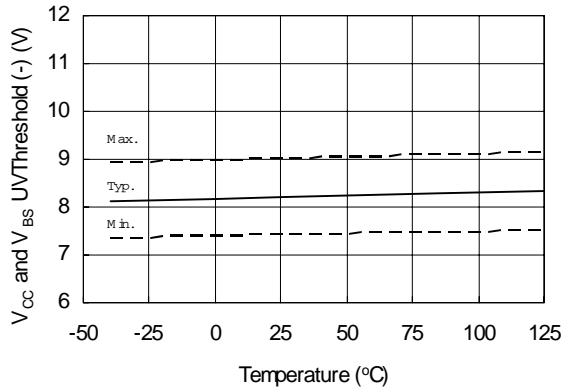

Figure 22. V_{CC} and V_{BS} Undervoltage Threshold (-) vs. Temperature

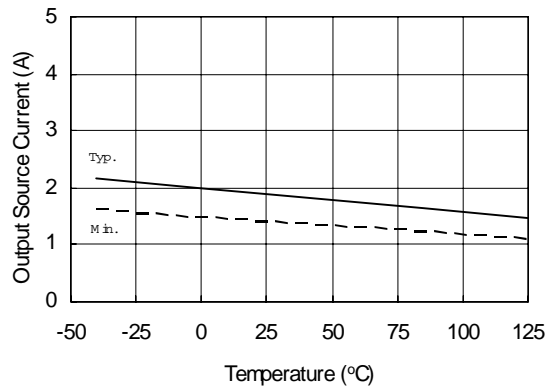

Figure 23A. Output Source Current vs. Temperature

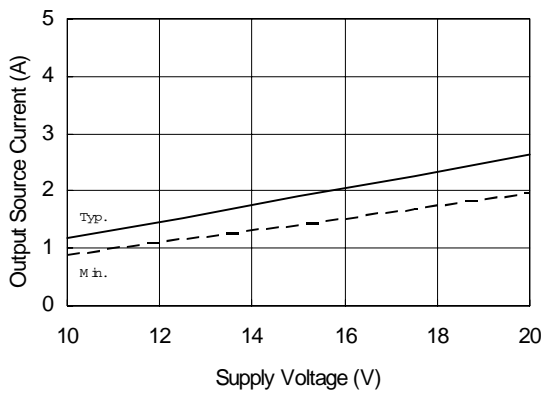

Figure 23B. Output Source Current vs. Supply Voltage

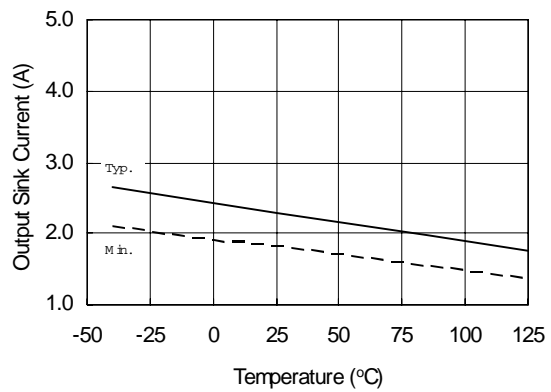

Figure 24A. Output Sink Current vs. Temperature

IR2184(4)(S)&(PbF)

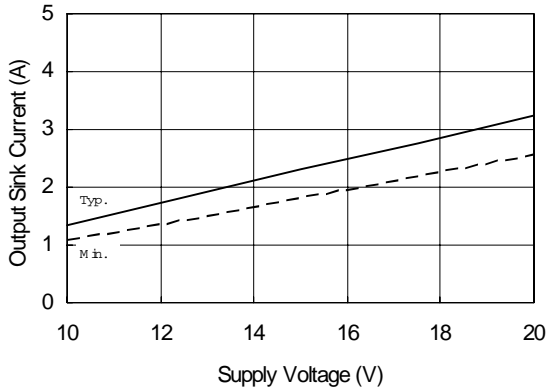

Figure 24B. Output Sink Current vs. Supply Voltage

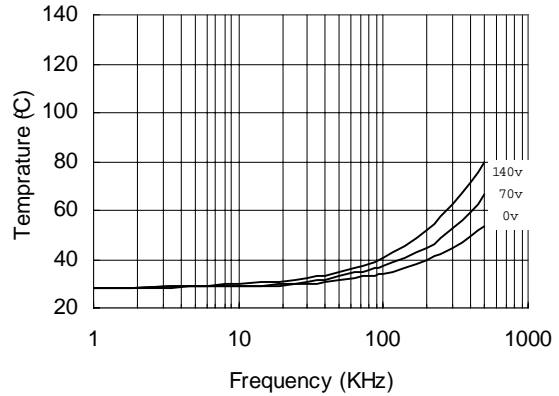

Figure 21. IR2181 vs. Frequency (IRFBC 20),
 $R_{gate} = 33\Omega, V_{CC} = 15V$

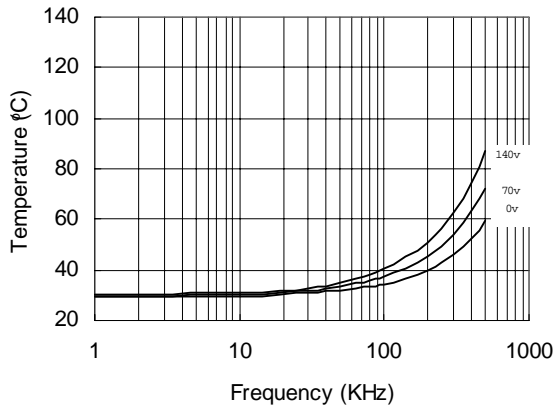

Figure 22. IR2181 vs. Frequency (IRFBC 30),
 $R_{gate} = 22\Omega, V_{CC} = 15V$

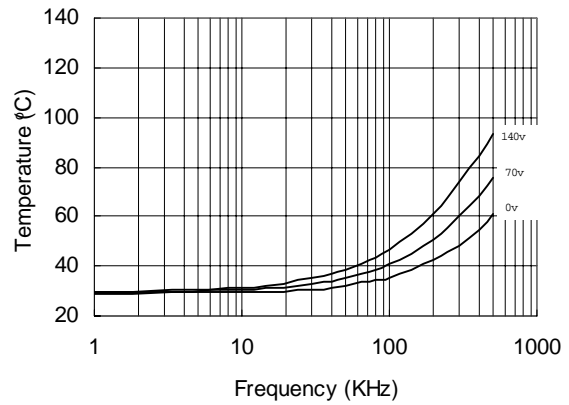

Figure 23. IR2181 vs. Frequency (IRFBC 40),
 $R_{gate} = 15\Omega, V_{CC} = 15V$

IR2184(4)(S)&(PbF)

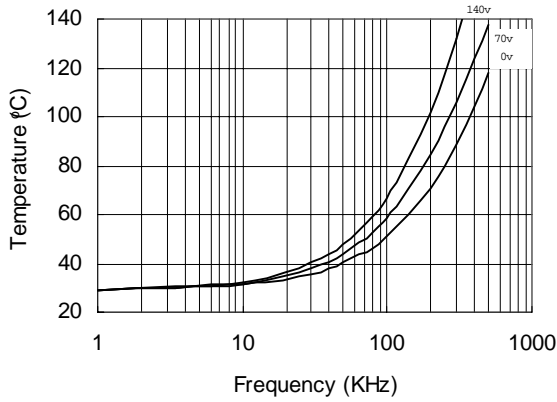

Figure 24. IR2181 vs. Frequency (IRFPE50),
 $R_{gate} = 10\Omega, V_{CC} = 15V$

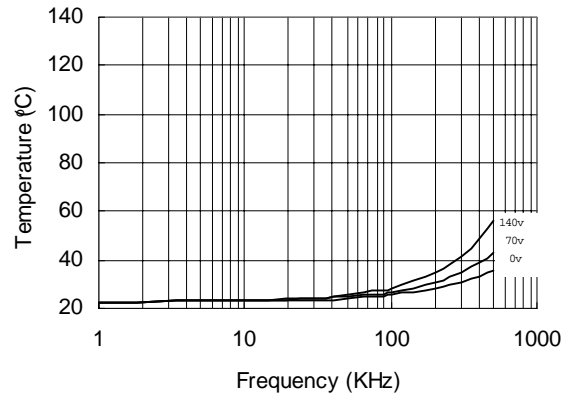

Figure 25. IR21814 vs. Frequency (IRFBC 20),
 $R_{gate} = 33\Omega, V_{CC} = 15V$

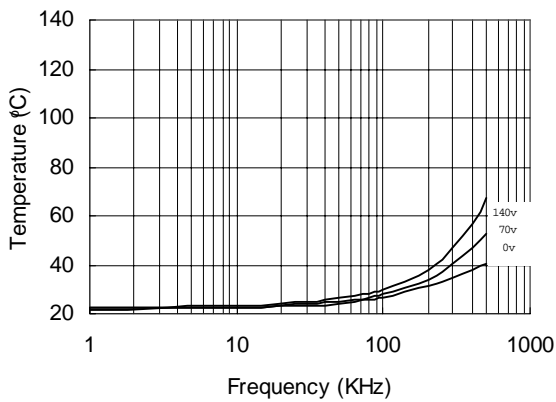

Figure 26. IR21814 vs. Frequency (IRFBC 30),
 $R_{gate} = 22\Omega, V_{CC} = 15V$

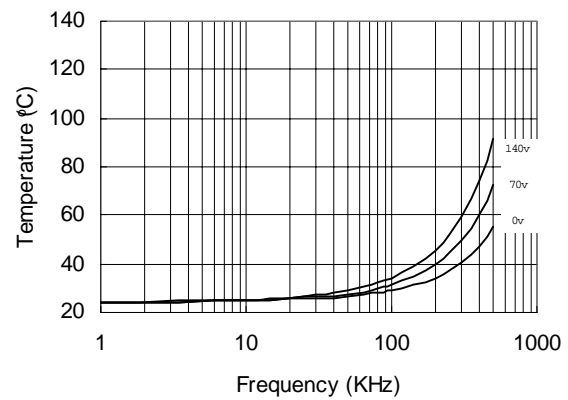

Figure 27. IR21814 vs. Frequency (IRFBC 40),
 $R_{gate} = 15\Omega, V_{CC} = 15V$

IR2184(4)(S)&(PbF)

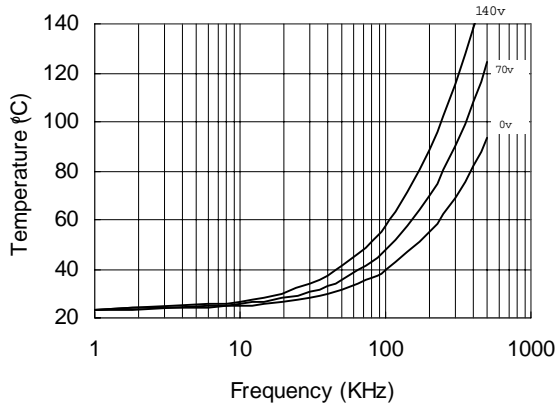

Figure 28. IR21814 vs. Frequency (IRFPE50),
 $R_{gate} = 10\Omega, V_{CC} = 15V$

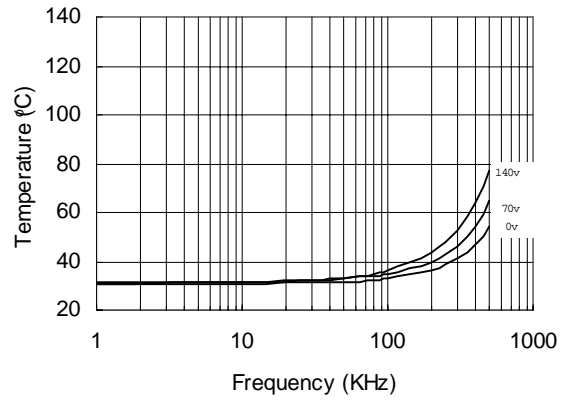

Figure 29. IR2181s vs. Frequency (IRFBC 20),
 $R_{gate} = 33\Omega, V_{CC} = 15V$

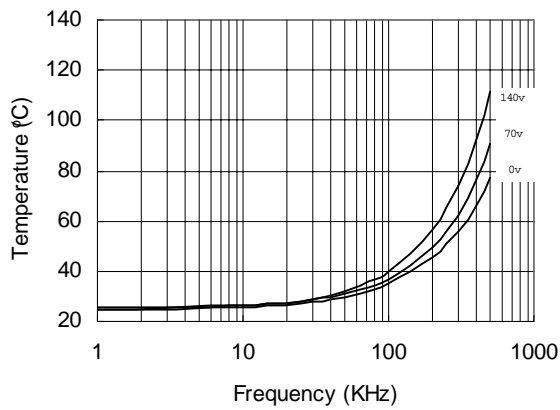

Figure 30. IR2181s vs. Frequency (IRFBC 30),
 $R_{gate} = 22\Omega, V_{CC} = 15V$

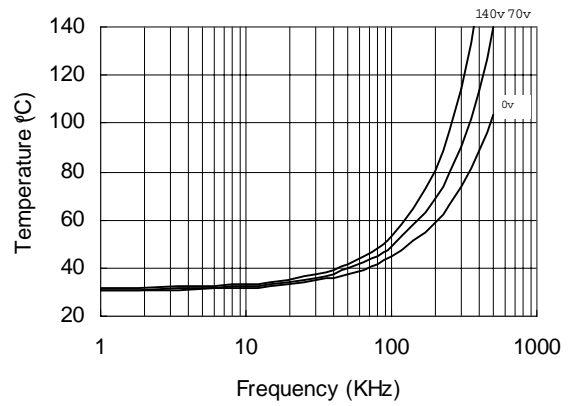

Figure 31. IR2181s vs. Frequency (IRFBC 40),
 $R_{gate} = 15\Omega, V_{CC} = 15V$

IR2184(4)(S)&(PbF)

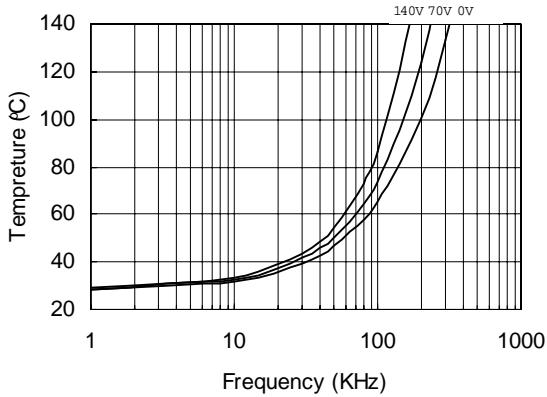

Figure 32. IR2181s vs. Frequency (IRFPE50),
 $R_{gate}=10\Omega, V_{CC}=15V$

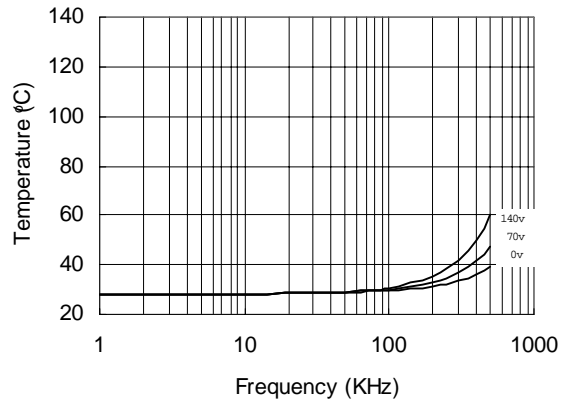

Figure 33. IR21814s vs. Frequency (IRFBC20),
 $R_{gate}=33\Omega, V_{CC}=15V$

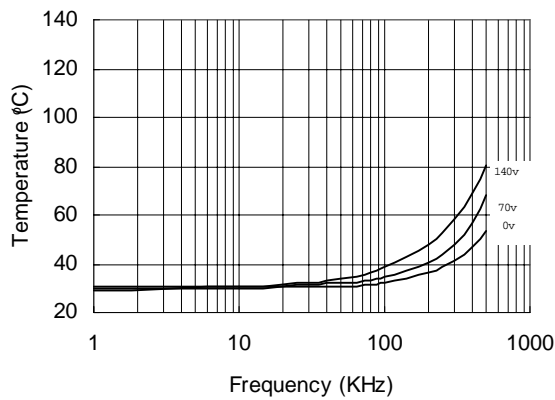

Figure 34. IR21814s vs. Frequency (IRFBC30),
 $R_{gate}=22\Omega, V_{CC}=15V$

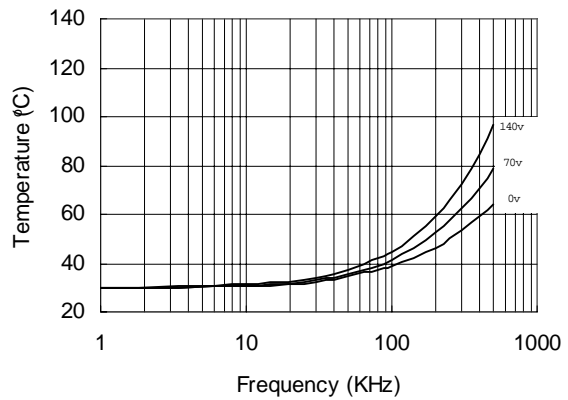
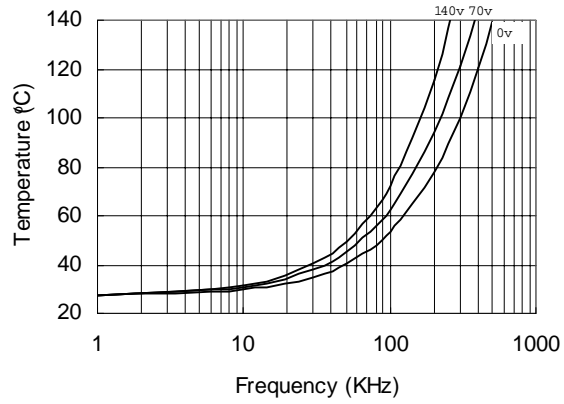

Figure 35. IR21814s vs. Frequency (IRFBC40),
 $R_{gate}=15\Omega, V_{CC}=15V$



**Figure 36. IR2184s vs. Frequency (IRFPE50),
 $R_{gate}=10\Omega$, $V_{CC}=15V$**

IR2184(4)(S) & (PbF)

International
IR Rectifier

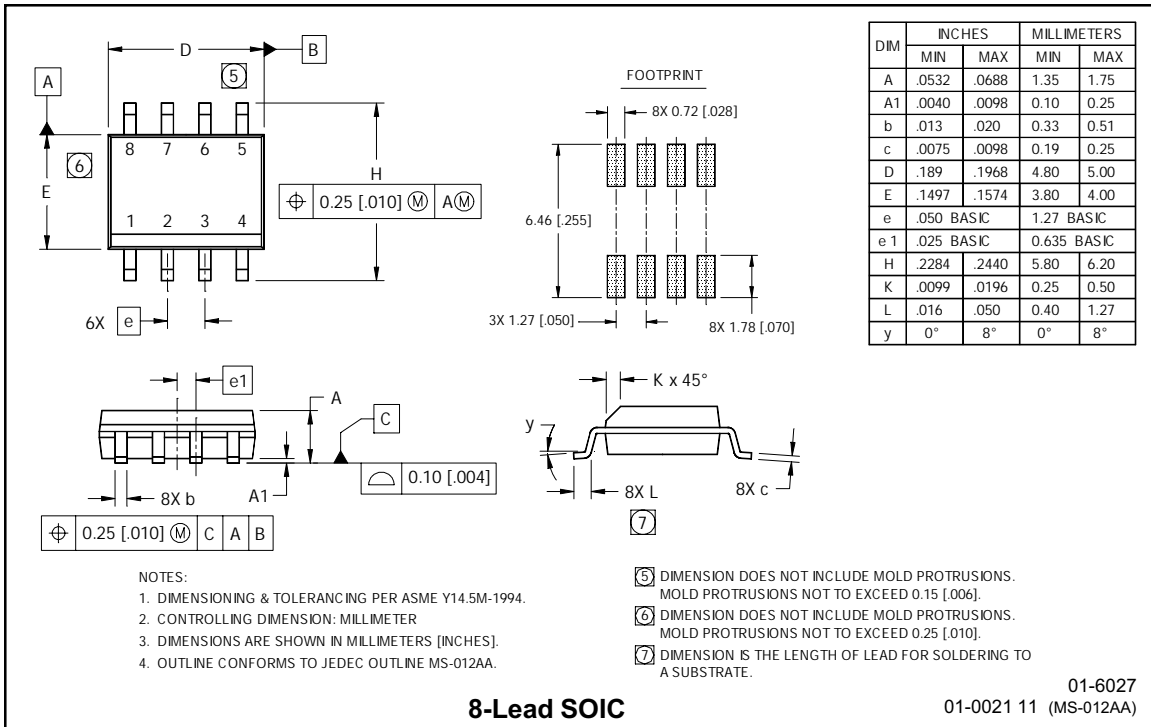
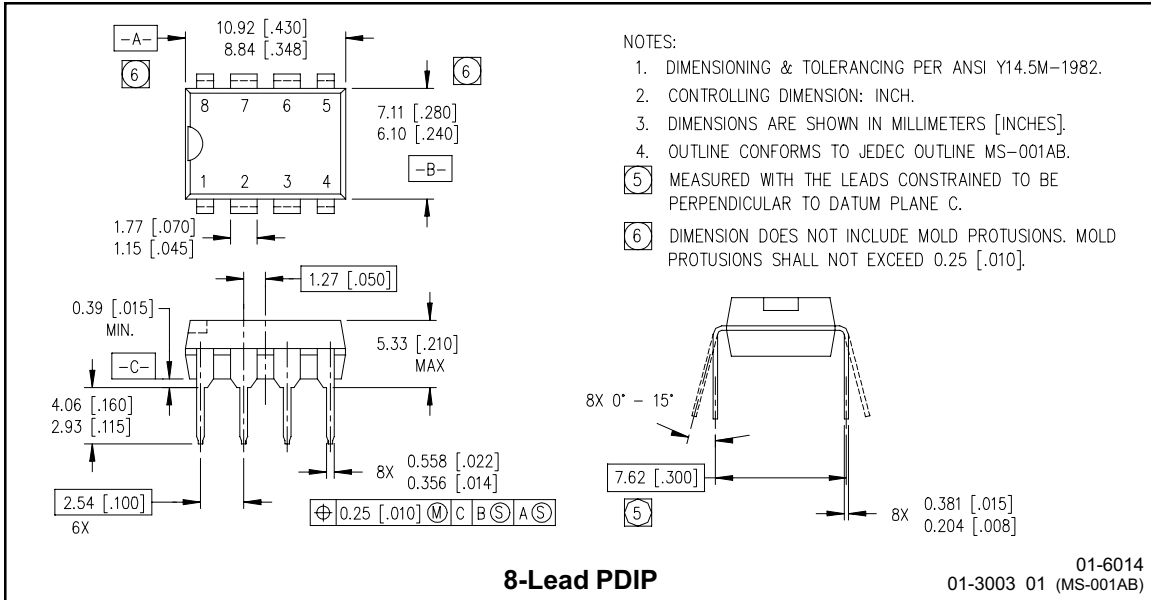

IR2184(4)(S)&(PbF)

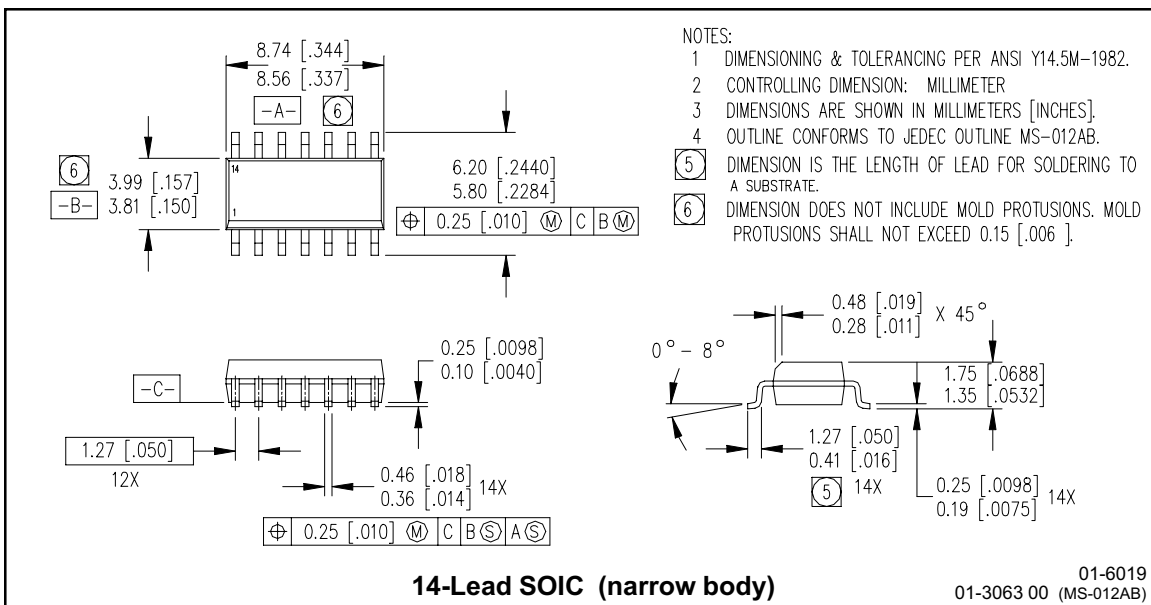
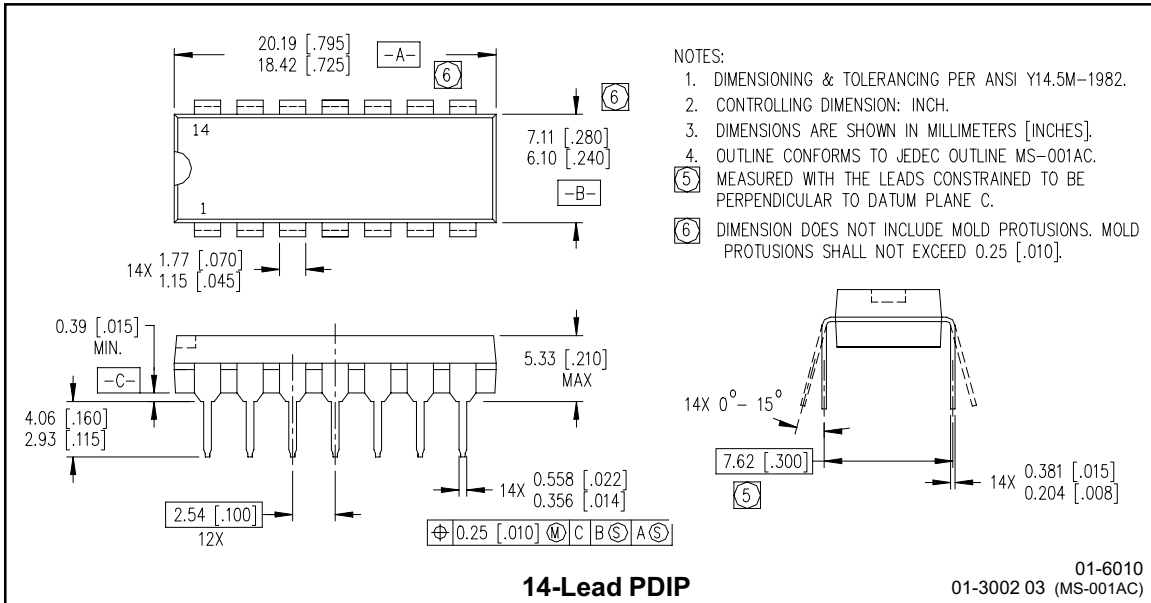

IR2184(4)(S)&(PbF)

LEADFREE PART MARKING INFORMATION

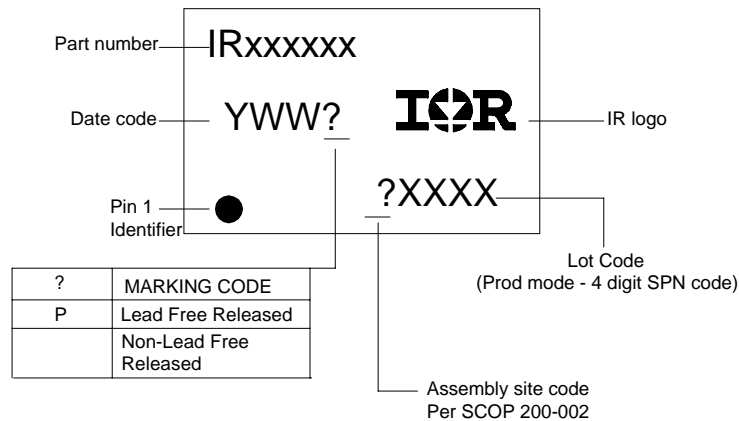

ORDER INFORMATION

Basic Part (Non-Lead Free)

8-Lead PDIP IR2184 order IR2184
 8-Lead SOIC IR2184S order IR2184S
 14-Lead PDIP IR21844 order IR21844
 14-Lead SOIC IR21844 order IR21844S

Leadfree Part

8-Lead PDIP IR2184 order IR2184PbF
 8-Lead SOIC IR2184S order IR2184SPbF
 14-Lead PDIP IR21844 order IR21844PbF
 14-Lead SOIC IR21844 order IR21844SPbF

Looking for pricing, stock, or lifecycle information?

Click below to explore more details on WIN SOURCE:

- ⊖ [View AOZ1038DI on WIN SOURCE](#)
- ⊖ [Alpha & Omega Semiconductor Inc. Information](#)

Optimize Your Supply Chain with WIN SOURCE Solutions

- ✓ Global Sourcing Solution
- ✓ Obsolete Management
- ✓ Cost Control Management
- ✓ Shortage Management
- ✓ Alternative Solution
- ✓ Excess Inventory Management