



**THE DATASHEET OF
LMC6062IN/NOPB**



LMC6062 Precision CMOS Dual Micropower Operational Amplifier

Check for Samples: [LMC6062](#)

FEATURES

- (Typical Unless Otherwise Noted)
- Low Offset Voltage 100 μ V
- Ultra Low Supply current 16 μ A/Amplifier
- Operates from 4.5V to 15V Single Supply
- Ultra Low Input Bias Current 10fA
- Output Swing within 10mV of Supply Rail, 100k Load
- Input Common-Mode Range Includes V^-
- High Voltage Gain 140dB
- Improved Latchup Immunity

APPLICATIONS

- Instrumentation Amplifier
- Photodiode and Infrared Detector Preamplifier
- Transducer Amplifiers
- Hand-Held Analytic Instruments
- Medical Instrumentation
- D/A Converter
- Charge Amplifier for Piezoelectric Transducers

Connection Diagram

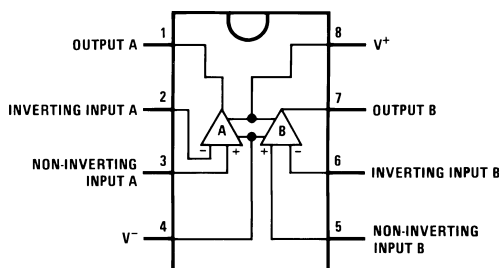

Figure 1. 8-Pin PDIP/SOIC
Top View

DESCRIPTION

The LMC6062 is a precision dual low offset voltage, micropower operational amplifier, capable of precision single supply operation. Performance characteristics include ultra low input bias current, high voltage gain, rail-to-rail output swing, and an input common mode voltage range that includes ground. These features, plus its low power consumption, make the LMC6062 ideally suited for battery powered applications.

Other applications using the LMC6062 include precision full-wave rectifiers, integrators, references, sample-and-hold circuits, and true instrumentation amplifiers.

This device is built with TI's advanced double-Poly Silicon-Gate CMOS process.

For designs that require higher speed, see the LMC6082 precision dual operational amplifier.

PATENT PENDING



Please be aware that an important notice concerning availability, standard warranty, and use in critical applications of Texas Instruments semiconductor products and disclaimers thereto appears at the end of this data sheet.

All trademarks are the property of their respective owners.



This integrated circuit can be damaged by ESD. Texas Instruments recommends that all integrated circuits be handled with appropriate precautions. Failure to observe proper handling and installation procedures can cause damage.

ESD damage can range from subtle performance degradation to complete device failure. Precision integrated circuits may be more susceptible to damage because very small parametric changes could cause the device not to meet its published specifications.

Absolute Maximum Ratings ⁽¹⁾⁽²⁾

Differential Input Voltage	±Supply Voltage
Voltage at Input/Output Pin	(V ⁺) +0.3V, (V ⁻) -0.3V
Supply Voltage (V ⁺ - V ⁻)	16V
Output Short Circuit to V ⁺	See ⁽³⁾
Output Short Circuit to V ⁻	See ⁽⁴⁾
Lead Temperature (Soldering, 10 sec.)	260°C
Storage Temp. Range	-65°C to +150°C
Junction Temperature	150°C
ESD Tolerance ⁽⁵⁾	2 kV
Current at Input Pin	±10 mA
Current at Output Pin	±30 mA
Current at Power Supply Pin	40 mA
Power Dissipation	See ⁽⁶⁾

- (1) Absolute Maximum Ratings indicate limits beyond which damage to the device may occur. Operating Ratings indicate conditions for which the device is intended to be functional, but do not ensure specific performance limits. For ensured specifications and test conditions, see the Electrical Characteristics. The ensured specifications apply only for the test conditions listed.
- (2) If Military/Aerospace specified devices are required, please contact the TI Sales Office/Distributors for availability and specifications
- (3) Do not connect output to V⁺, when V⁺ is greater than 13V or reliability will be adversely affected.
- (4) Applies to both single-supply and split-supply operation. Continuous short circuit operation at elevated ambient temperature can result in exceeding the maximum allowed junction temperature of 150°C. Output currents in excess of ±30 mA over long term may adversely affect reliability.
- (5) Human body model, 1.5 kΩ in series with 100 pF.
- (6) The maximum power dissipation is a function of T_{J(Max)}, θ_{JA}, and T_A. The maximum allowable power dissipation at any ambient temperature is P_D = (T_{J(Max)} - T_A)/θ_{JA}.

Operating Ratings ⁽¹⁾

Temperature Range	LMC6062AM	-55°C ≤ T _J ≤ +125°C
	LMC6062AI, LMC6082I	-40°C ≤ T _J ≤ +85°C
Supply Voltage		4.5V ≤ V ⁺ ≤ 15.5V
Thermal Resistance (θ _{JA}) ⁽²⁾	8-Pin PDIP	115°C/W
	8-Pin SOIC	193°C/W
Power Dissipation		See ⁽³⁾

- (1) Absolute Maximum Ratings indicate limits beyond which damage to the device may occur. Operating Ratings indicate conditions for which the device is intended to be functional, but do not ensure specific performance limits. For ensured specifications and test conditions, see the Electrical Characteristics. The ensured specifications apply only for the test conditions listed.
- (2) All numbers apply for packages soldered directly into a PC board.
- (3) For operating at elevated temperatures the device must be derated based on the thermal resistance θ_{JA} with P_D = (T_J-T_A)/θ_{JA}.

DC Electrical Characteristics ⁽¹⁾

Unless otherwise specified, all limits ensured for T_J = 25°C. **Boldface** limits apply at the temperature extremes. V⁺ = 5V, V⁻ = 0V, V_{CM} = 1.5V, V_O = 2.5V and R_L > 1M unless otherwise specified.

Symbol	Parameter	Conditions	Typ ⁽²⁾	LMC6062AM Limit ⁽³⁾	LMC6062AI Limit ⁽³⁾	LMC6062I Limit ⁽³⁾	Units
V _{OS}	Input Offset Voltage		100	350	350	800	μV
				1200	900	1300	Max

- (1) For ensured Military Temperature Range parameters, see RETSMC6062X.
- (2) Typical values represent the most likely parametric norm.
- (3) All limits are ensured by testing or statistical analysis.

DC Electrical Characteristics⁽¹⁾ (continued)

Unless otherwise specified, all limits ensured for $T_J = 25^\circ\text{C}$. **Boldface** limits apply at the temperature extremes. $V^+ = 5\text{V}$, $V^- = 0\text{V}$, $V_{CM} = 1.5\text{V}$, $V_O = 2.5\text{V}$ and $R_L > 1\text{M}$ unless otherwise specified.

Symbol	Parameter	Conditions	Typ ⁽²⁾	LMC6062AM Limit ⁽³⁾	LMC6062AI Limit ⁽³⁾	LMC6062I Limit ⁽³⁾	Units	
TCV _{OS}	Input Offset Voltage Average Drift		1.0				$\mu\text{V}/^\circ\text{C}$	
I _B	Input Bias Current		0.010	100	4	4	pA Max	
I _{OS}	Input Offset Current		0.005	100	2	2	pA Max	
R _{IN}	Input Resistance		>10				Tera Ω	
CMRR	Common Mode Rejection Ratio	$0\text{V} \leq V_{CM} \leq 12.0\text{V}$ $V^+ = 15\text{V}$	85	75 70	75 72	66 63	dB Min	
+PSRR	Positive Power Supply Rejection Ratio	$5\text{V} \leq V^+ \leq 15\text{V}$ $V_O = 2.5\text{V}$	85	75 70	75 72	66 63	dB Min	
-PSRR	Negative Power Supply Rejection Ratio	$0\text{V} \leq V^- \leq -10\text{V}$	100	84 70	84 81	74 71	dB Min	
V _{CM}	Input Common-Mode Voltage Range	$V^+ = 5\text{V}$ and 15V for CMRR ≥ 60 dB	-0.4	-0.1 0	-0.1 0	-0.1 0	V Max	
			$V^+ - 1.9$	$V^+ - 2.3$ $V^+ - 2.6$	$V^+ - 2.3$ $V^+ - 2.5$	$V^+ - 2.3$ $V^+ - 2.5$	V Min	
A _V	Large Signal Voltage Gain	$R_L = 100\text{ k}\Omega$ ⁽⁴⁾	Sourcing	4000	400 200	400 300	300 200	V/mV Min
			Sinking	3000	180 70	180 100	90 60	V/mV Min
		$R_L = 25\text{ k}\Omega$ ⁽⁴⁾	Sourcing	3000	400 150	400 150	200 80	V/mV Min
			Sinking	2000	100 35	100 50	70 35	V/mV Min
V _O	Output Swing	$V^+ = 5\text{V}$ $R_L = 100\text{ k}\Omega$ to 2.5V	4.995	4.990 4.970	4.990 4.980	4.950 4.925	V Min	
			0.005	0.010 0.030	0.010 0.020	0.050 0.075	V Max	
		$V^+ = 5\text{V}$ $R_L = 25\text{ k}\Omega$ to 2.5V	4.990	4.975 4.955	4.975 4.965	4.950 4.850	V Min	
			0.010	0.020 0.045	0.020 0.035	0.050 0.150	V Max	
		$V^+ = 15\text{V}$ $R_L = 100\text{ k}\Omega$ to 7.5V	14.990	14.975 14.955	14.975 14.965	14.950 14.925	V Min	
			0.010	0.025 0.050	0.025 0.035	0.050 0.075	V Max	
		$V^+ = 15\text{V}$ $R_L = 25\text{ k}\Omega$ to 7.5V	14.965	14.900 14.800	14.900 14.850	14.850 14.800	V Min	
			0.025	0.050 0.200	0.050 0.150	0.100 0.200	V Max	

(4) $V^+ = 15\text{V}$, $V_{CM} = 7.5\text{V}$ and R_L connected to 7.5V . For Sourcing tests, $7.5\text{V} \leq V_O \leq 11.5\text{V}$. For Sinking tests, $2.5\text{V} \leq V_O \leq 7.5\text{V}$.

DC Electrical Characteristics⁽¹⁾ (continued)

Unless otherwise specified, all limits ensured for $T_J = 25^\circ\text{C}$. **Boldface** limits apply at the temperature extremes. $V^+ = 5\text{V}$, $V^- = 0\text{V}$, $V_{CM} = 1.5\text{V}$, $V_O = 2.5\text{V}$ and $R_L > 1\text{M}$ unless otherwise specified.

Symbol	Parameter	Conditions	Typ ⁽²⁾	LMC6062AM Limit ⁽³⁾	LMC6062AI Limit ⁽³⁾	LMC6062I Limit ⁽³⁾	Units
I_O	Output Current $V^+ = 5\text{V}$	Sourcing, $V_O = 0\text{V}$	22	16 8	16 10	13 8	mA Min
		Sinking, $V_O = 5\text{V}$	21	16 7	16 8	16 8	mA Min
I_O	Output Current $V^+ = 15\text{V}$	Sourcing, $V_O = 0\text{V}$	25	15 9	15 10	15 10	mA Min
		Sinking, $V_O = 13\text{V}$ ⁽⁵⁾	35	20 7	20 8	20 8	mA Min
I_S	Supply Current	Both Amplifiers $V^+ = +5\text{V}$, $V_O = 1.5\text{V}$	32	38 60	38 46	46 56	μA Max
		Both Amplifiers $V^+ = +15\text{V}$, $V_O = 7.5\text{V}$	40	47 70	47 55	57 66	μA Max

(5) Do not connect output to V^+ , when V^+ is greater than 13V or reliability will be adversely affected.

AC Electrical Characteristics⁽¹⁾

Unless otherwise specified, all limits ensured for $T_J = 25^\circ\text{C}$. **Boldface** limits apply at the temperature extremes. $V^+ = 5\text{V}$, $V^- = 0\text{V}$, $V_{CM} = 1.5\text{V}$, $V_O = 2.5\text{V}$ and $R_L > 1\text{M}$ unless otherwise specified.

Symbol	Parameter	Conditions	Typ ⁽²⁾	LMC6062AM Limit ⁽³⁾	LMC6062AI Limit ⁽³⁾	LMC6062I Limit ⁽³⁾	Units
SR	Slew Rate	See ⁽⁴⁾	35	20 8	20 10	15 7	V/ms Min
				GBW	Gain-Bandwidth Product	100	
θ_m	Phase Margin		50				Deg
	Amp-to-Amp Isolation	See ⁽⁵⁾	155				dB
e_n	Input-Referred Voltage Noise	$F = 1\text{ kHz}$	83				$\text{nV}/\sqrt{\text{Hz}}$
i_n	Input-Referred Current Noise	$F = 1\text{ kHz}$	0.0002				$\text{pA}/\sqrt{\text{Hz}}$
T.H.D.	Total Harmonic Distortion	$F = 1\text{ kHz}$, $A_V = -5$ $R_L = 100\text{ k}\Omega$, $V_O = 2\text{ V}_{PP}$ $\pm 5\text{V}$ Supply	0.01				%

(1) For ensured Military Temperature Range parameters, see RETSMC6062X.

(2) Typical values represent the most likely parametric norm.

(3) All limits are ensured by testing or statistical analysis.

(4) $V^+ = 15\text{V}$. Connected as Voltage Follower with 10V step input. Number specified is the slower of the positive and negative slew rates.

(5) Input referred $V^+ = 15\text{V}$ and $R_L = 100\text{ k}\Omega$ connected to 7.5V. Each amp excited in turn with 100 Hz to produce $V_O = 12\text{ V}_{PP}$.

Typical Performance Characteristics

$V_S = \pm 7.5V$, $T_A = 25^\circ C$, Unless otherwise specified

Distribution of LMC6062 Input Offset Voltage ($T_A = +25^\circ C$)

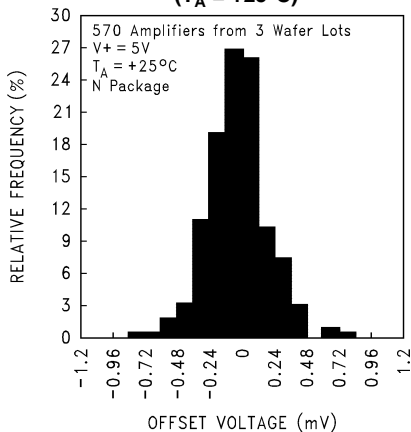

Figure 2.

Distribution of LMC6062 Input Offset Voltage ($T_A = -55^\circ C$)

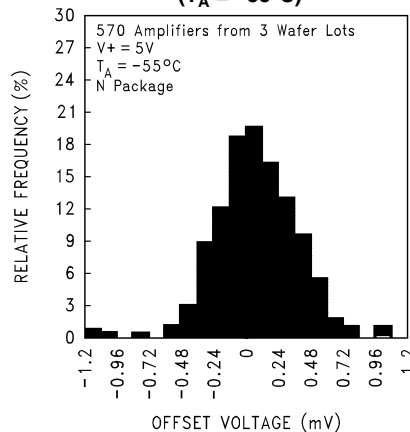

Figure 3.

Distribution of LMC6062 Input Offset Voltage ($T_A = +125^\circ C$)

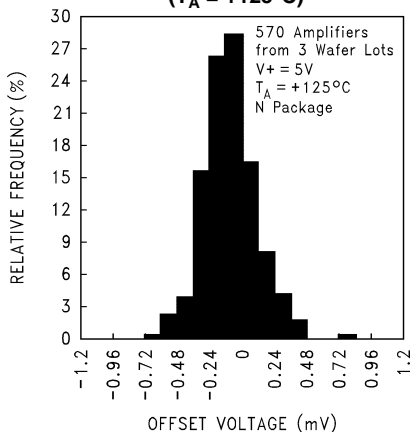

Figure 4.

Input Bias Current vs. Temperature

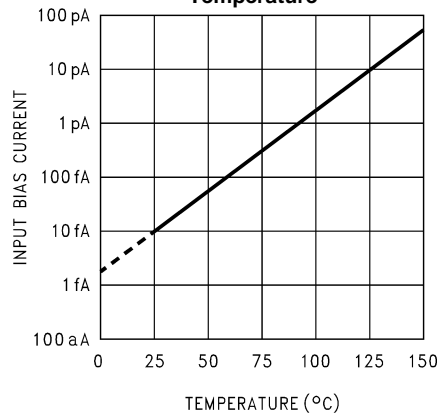

Figure 5.

Supply Current vs. Supply Voltage

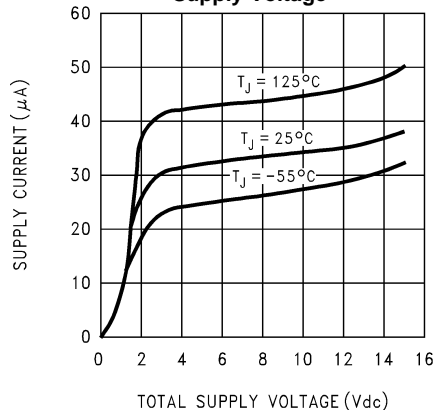

Figure 6.

Input Voltage vs. Output Voltage

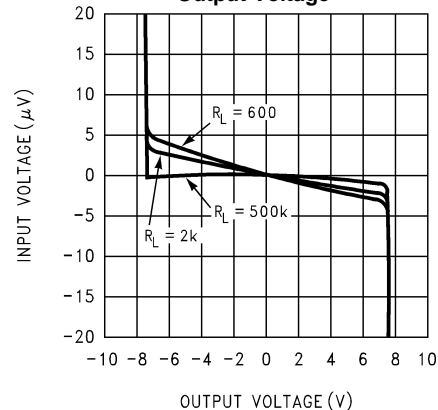

Figure 7.

Typical Performance Characteristics (continued)

$V_S = \pm 7.5V$, $T_A = 25^\circ C$, Unless otherwise specified

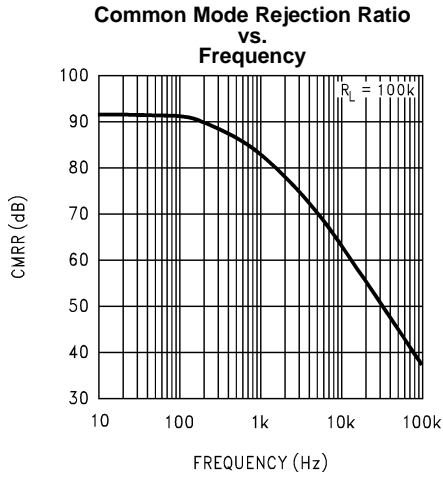

Figure 8.

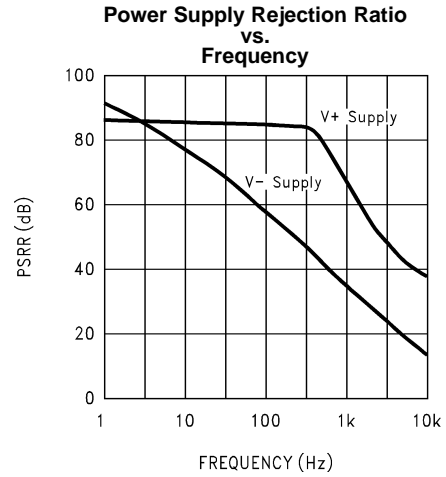

Figure 9.

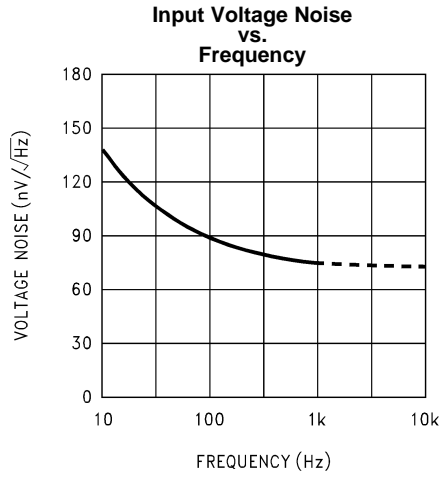

Figure 10.

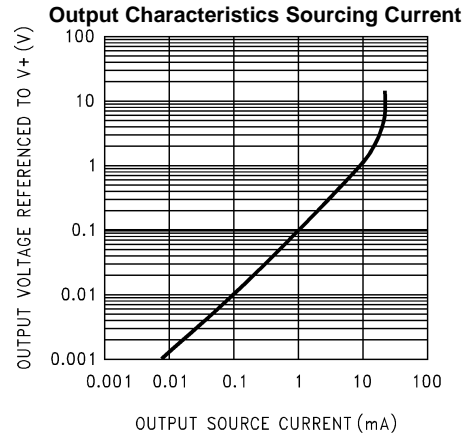

Figure 11.

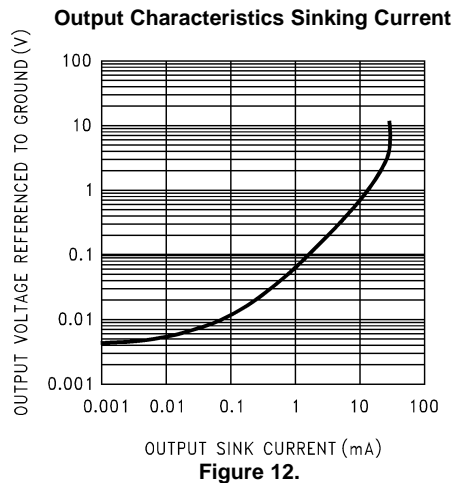

Figure 12.

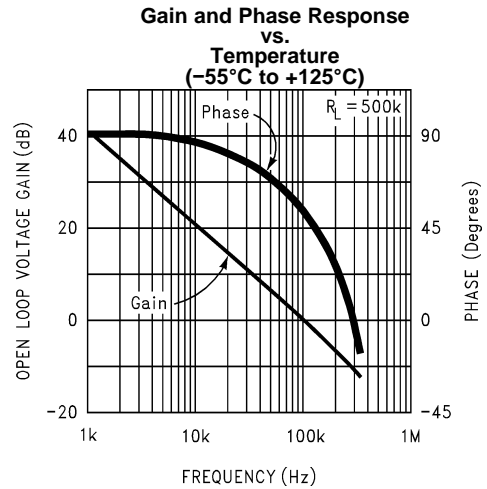

Figure 13.

Typical Performance Characteristics (continued)

$V_S = \pm 7.5V$, $T_A = 25^\circ C$, Unless otherwise specified

Gain and Phase Response vs. Capacitive Load with $R_L = 20\text{ k}\Omega$

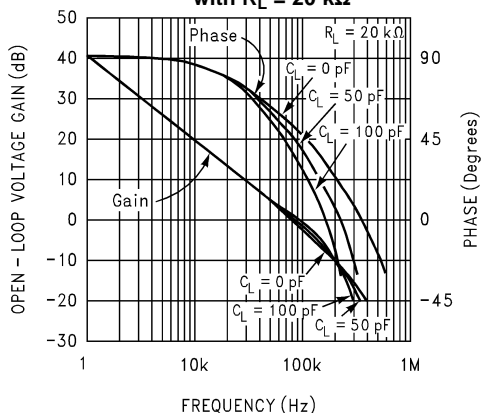

Figure 14.

Gain and Phase Response vs. Capacitive Load with $R_L = 500\text{ k}\Omega$

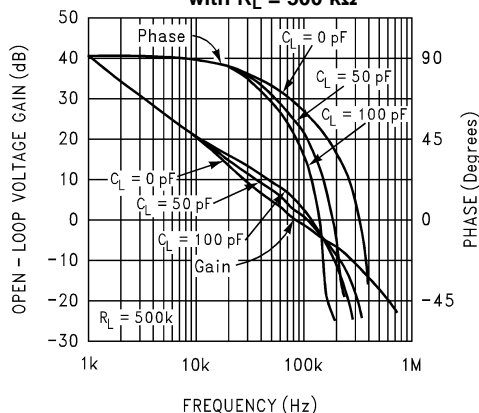

Figure 15.

Open Loop Frequency Response

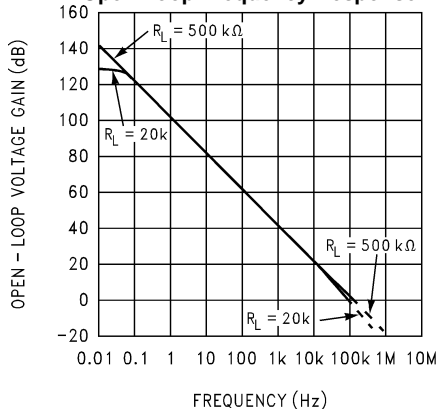

Figure 16.

Inverting Small Signal Pulse Response

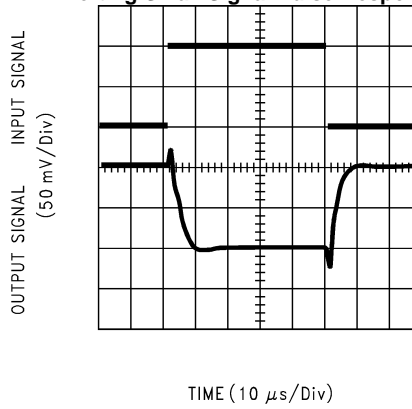

Figure 17.

Inverting Large Signal Pulse Response

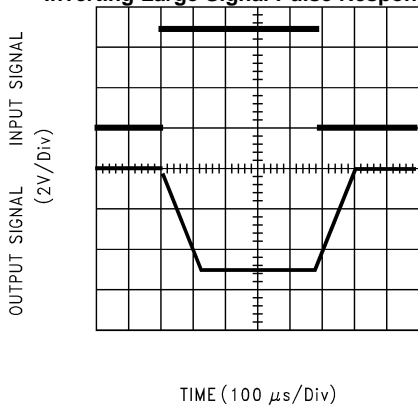

Figure 18.

Non-Inverting Small Signal Pulse Response

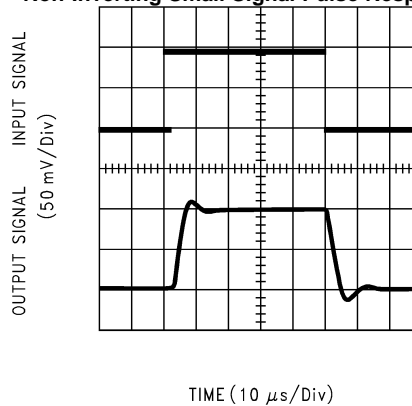
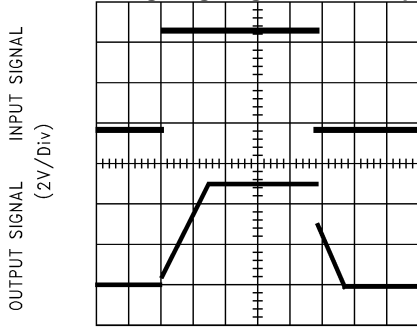

Figure 19.

Typical Performance Characteristics (continued)

$V_S = \pm 7.5V$, $T_A = 25^\circ C$, Unless otherwise specified

Non-Inverting Large Signal Pulse Response



TIME (100 μs /Div)

Figure 20.

Crosstalk Rejection vs. Frequency

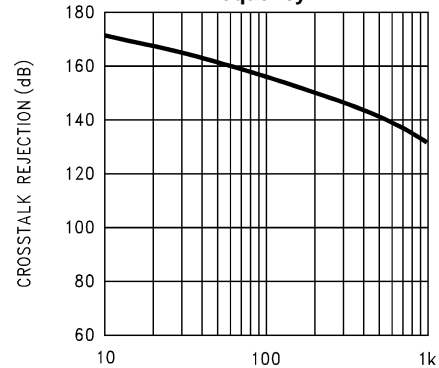

FREQUENCY (Hz)

Figure 21.

Stability vs. Capacitive Load, $R_L = 20\text{ k}\Omega$

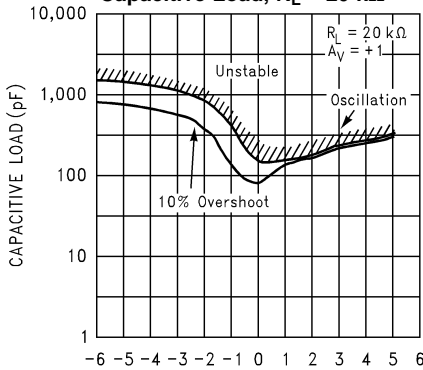

OUTPUT VOLTAGE (V)

Figure 22.

Stability vs. Capacitive Load $R_L = 1\text{ M}\Omega$

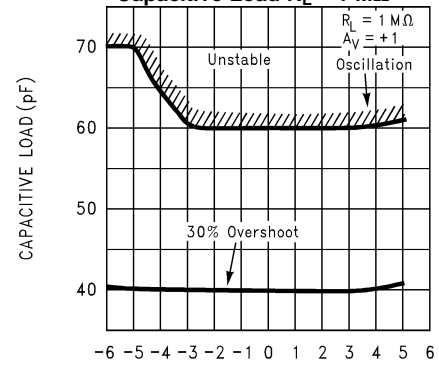

OUTPUT VOLTAGE (V)

Figure 23.

APPLICATIONS HINTS

AMPLIFIER TOPOLOGY

The LMC6062 incorporates a novel op-amp design topology that enables it to maintain rail-to-rail output swing even when driving a large load. Instead of relying on a push-pull unity gain output buffer stage, the output stage is taken directly from the internal integrator, which provides both low output impedance and large gain. Special feed forward compensation design techniques are incorporated to maintain stability over a wider range of operating conditions than traditional micropower op amps. These features make the LMC6062 both easier to design with, and provide higher speed than products typically found in this ultra low power class.

COMPENSATING FOR INPUT CAPACITANCE

It is quite common to use large values of feedback resistance for amplifiers with ultra-low input current, like the LMC6062.

Although the LMC6062 is highly stable over a wide range of operating conditions, certain precautions must be met to achieve the desired pulse response when a large feedback resistor is used. Large feedback resistors and even small values of input capacitance, due to transducers, photodiodes, and circuit board parasitics, reduce phase margins.

When high input impedances are demanded, guarding of the LMC6062 is suggested. Guarding input lines will not only reduce leakage, but lowers stray input capacitance as well. (See [PRINTED-CIRCUIT-BOARD LAYOUT FOR HIGH-IMPEDANCE WORK](#)).

The effect of input capacitance can be compensated for by adding a capacitor. Place a capacitor, C_f , around the feedback resistor (as in [Figure 24](#)) such that:

$$\frac{1}{2\pi R_1 C_{IN}} \geq \frac{1}{2\pi R_2 C_f} \quad (1)$$

or

$$R_1 C_{IN} \leq R_2 C_f \quad (2)$$

Since it is often difficult to know the exact value of C_{IN} , C_f can be experimentally adjusted so that the desired pulse response is achieved. Refer to the LMC660 and the LMC662 for a more detailed discussion on compensating for input capacitance.

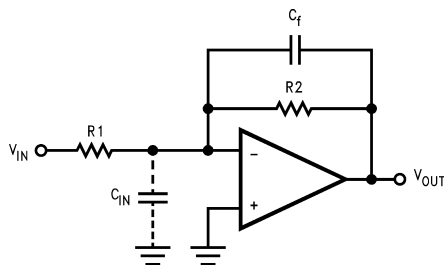

Figure 24. Canceling the Effect of Input Capacitance

CAPACITIVE LOAD TOLERANCE

All rail-to-rail output swing operational amplifiers have voltage gain in the output stage. A compensation capacitor is normally included in this integrator stage. The frequency location of the dominate pole is affected by the resistive load on the amplifier. Capacitive load driving capability can be optimized by using an appropriate resistive load in parallel with the capacitive load (see [typical curves](#)).

Direct capacitive loading will reduce the phase margin of many op-amps. A pole in the feedback loop is created by the combination of the op-amp's output impedance and the capacitive load. This pole induces phase lag at the unity-gain crossover frequency of the amplifier resulting in either an oscillatory or underdamped pulse response. With a few external components, op amps can easily indirectly drive capacitive loads, as shown in [Figure 25](#).

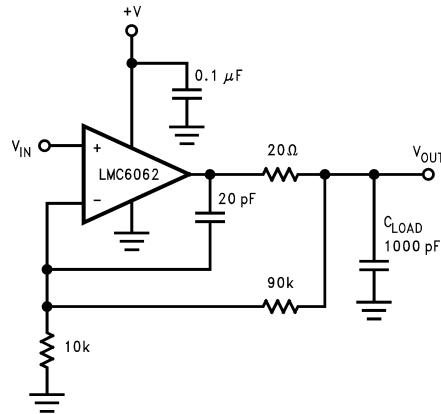

Figure 25. LMC6062 Noninverting Gain of 10 Amplifier, Compensated to Handle Capacitive Loads

In the circuit of [Figure 25](#), R1 and C1 serve to counteract the loss of phase margin by feeding the high frequency component of the output signal back to the amplifier's inverting input, thereby preserving phase margin in the overall feedback loop.

Capacitive load driving capability is enhanced by using a pull up resistor to V^+ ([Figure 26](#)). Typically a pull up resistor conducting 10 μA or more will significantly improve capacitive load responses. The value of the pull up resistor must be determined based on the current sinking capability of the amplifier with respect to the desired output swing. Open loop gain of the amplifier can also be affected by the pull up resistor (see [Electrical Characteristics](#)).

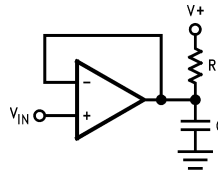

Figure 26. Compensating for Large Capacitive Loads with a Pull Up Resistor

PRINTED-CIRCUIT-BOARD LAYOUT FOR HIGH-IMPEDANCE WORK

It is generally recognized that any circuit which must operate with less than 1000 pA of leakage current requires special layout of the PC board. When one wishes to take advantage of the ultra-low bias current of the LMC6062, typically less than 10 fA, it is essential to have an excellent layout. Fortunately, the techniques of obtaining low leakages are quite simple. First, the user must not ignore the surface leakage of the PC board, even though it may sometimes appear acceptably low, because under conditions of high humidity or dust or contamination, the surface leakage will be appreciable.

To minimize the effect of any surface leakage, lay out a ring of foil completely surrounding the LMC6062's inputs and the terminals of capacitors, diodes, conductors, resistors, relay terminals etc. connected to the op-amp's inputs, as in [Figure 27](#). To have a significant effect, guard rings should be placed on both the top and bottom of the PC board. This PC foil must then be connected to a voltage which is at the same voltage as the amplifier inputs, since no leakage current can flow between two points at the same potential. For example, a PC board trace-to-pad resistance of $10^{12}\Omega$, which is normally considered a very large resistance, could leak 5 pA if the trace were a 5V bus adjacent to the pad of the input. This would cause a 100 times degradation from the LMC6062's actual performance. However, if a guard ring is held within 5 mV of the inputs, then even a resistance of $10^{11}\Omega$ would cause only 0.05 pA of leakage current. See [Figure 28](#) for typical connections of guard rings for standard op-amp configurations.

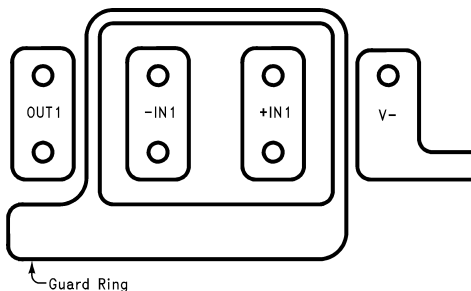

Figure 27. Example of Guard Ring in P.C. Board Layout

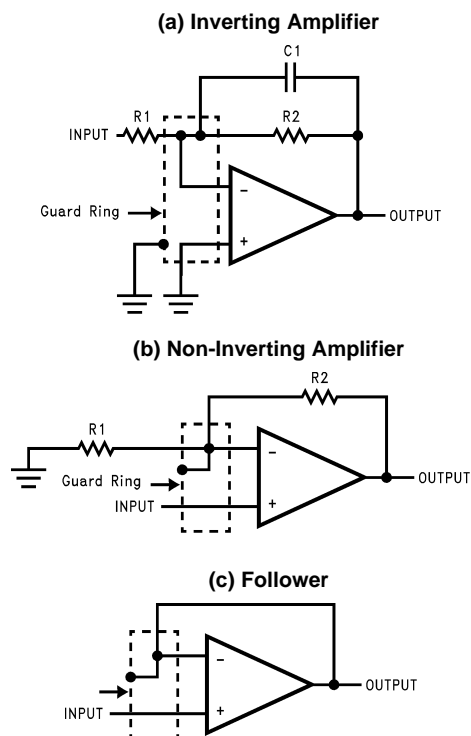
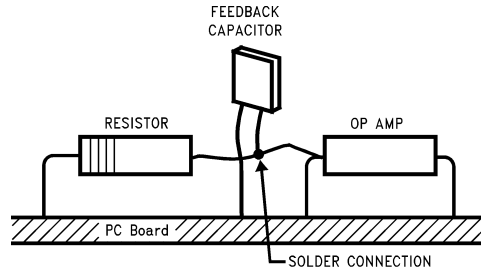

Figure 28. Typical Connections of Guard Rings

The designer should be aware that when it is inappropriate to lay out a PC board for the sake of just a few circuits, there is another technique which is even better than a guard ring on a PC board: Don't insert the amplifier's input pin into the board at all, but bend it up in the air and use only air as an insulator. Air is an excellent insulator. In this case you may have to forego some of the advantages of PC board construction, but the advantages are sometimes well worth the effort of using point-to-point up-in-the-air wiring. See [Figure 29](#).

Latchup

CMOS devices tend to be susceptible to latchup due to their internal parasitic SCR effects. The (I/O) input and output pins look similar to the gate of the SCR. There is a minimum current required to trigger the SCR gate lead. The LMC6062 and LMC6082 are designed to withstand 100 mA surge current on the I/O pins. Some resistive method should be used to isolate any capacitance from supplying excess current to the I/O pins. In addition, like an SCR, there is a minimum holding current for any latchup mode. Limiting current to the supply pins will also inhibit latchup susceptibility.



(Input pins are lifted out of PC board and soldered directly to components. All other pins connected to PC board).

Figure 29. Air Wiring

Typical Single-Supply Applications

($V^+ = 5.0 V_{DC}$)

The extremely high input impedance, and low power consumption, of the LMC6062 make it ideal for applications that require battery-powered instrumentation amplifiers. Examples of these types of applications are hand-held pH probes, analytic medical instruments, magnetic field detectors, gas detectors, and silicon based pressure transducers.

Figure 30 shows an instrumentation amplifier that features high differential and common mode input resistance ($>10^{14}\Omega$), 0.01% gain accuracy at $A_V = 100$, excellent CMRR with 1 k Ω imbalance in bridge source resistance. Input current is less than 100 fA and offset drift is less than 2.5 $\mu V/^\circ C$. R_2 provides a simple means of adjusting gain over a wide range without degrading CMRR. R_7 is an initial trim used to maximize CMRR without using super precision matched resistors. For good CMRR over temperature, low drift resistors should be used.

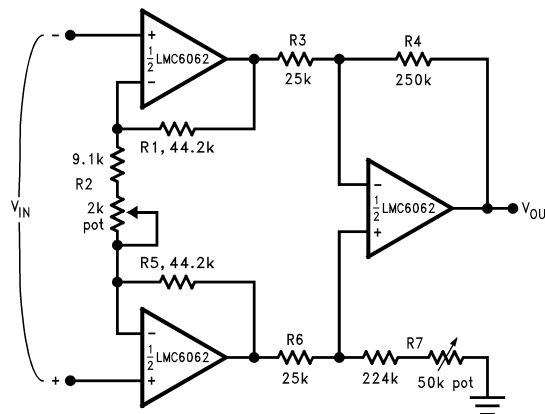

If $R_1 = R_5$, $R_3 = R_6$, and $R_4 = R_7$; then

$$\frac{V_{OUT}}{V_{IN}} = \frac{R_2 + 2R_1}{R_2} \times \frac{R_4}{R_3}$$

$\therefore A_V \approx 100$ for circuit shown ($R_2 = 9.822k$).

Figure 30. Instrumentation Amplifier

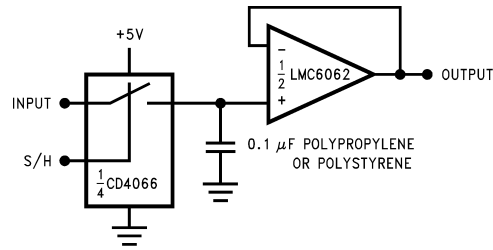

Figure 31. Low-Leakage Sample and Hold

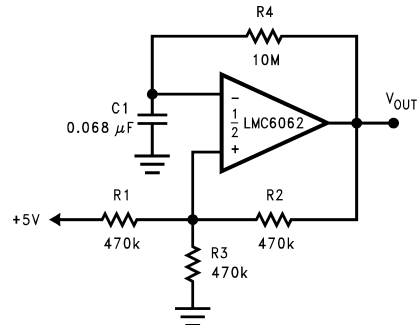

Figure 32. 1 Hz Square Wave Oscillator

REVISION HISTORY

Changes from Revision C (March 2013) to Revision D	Page
• Changed layout of National Data Sheet to TI format	13

PACKAGING INFORMATION

Orderable Device	Status (1)	Package Type	Package Drawing	Pins	Package Qty	Eco Plan (2)	Lead/Ball Finish (6)	MSL Peak Temp (3)	Op Temp (°C)	Device Marking (4/5)	Samples
LMC6062AIM	NRND	SOIC	D	8	95	TBD	Call TI	Call TI	-40 to 85	LMC6062AIM	
LMC6062AIM/NOPB	ACTIVE	SOIC	D	8	95	Green (RoHS & no Sb/Br)	CU SN	Level-1-260C-UNLIM	-40 to 85	LMC6062AIM	Samples
LMC6062AIMX/NOPB	ACTIVE	SOIC	D	8	2500	Green (RoHS & no Sb/Br)	CU SN	Level-1-260C-UNLIM	-40 to 85	LMC6062AIM	Samples
LMC6062I MDC	ACTIVE	DIESALE	Y	0	288	Green (RoHS & no Sb/Br)	Call TI	Level-1-NA-UNLIM	-40 to 85		Samples
LMC6062IM	NRND	SOIC	D	8	95	TBD	Call TI	Call TI	-40 to 85	LMC6062IM	
LMC6062IM/NOPB	ACTIVE	SOIC	D	8	95	Green (RoHS & no Sb/Br)	CU SN	Level-1-260C-UNLIM	-40 to 85	LMC6062IM	Samples
LMC6062IMX/NOPB	ACTIVE	SOIC	D	8	2500	Green (RoHS & no Sb/Br)	CU SN	Level-1-260C-UNLIM	-40 to 85	LMC6062IM	Samples
LMC6062IN/NOPB	ACTIVE	PDIP	P	8	40	Green (RoHS & no Sb/Br)	CU SN	Level-1-NA-UNLIM	-40 to 85	LMC6062IN	Samples

(1) The marketing status values are defined as follows:

ACTIVE: Product device recommended for new designs.

LIFEBUY: TI has announced that the device will be discontinued, and a lifetime-buy period is in effect.

NRND: Not recommended for new designs. Device is in production to support existing customers, but TI does not recommend using this part in a new design.

PREVIEW: Device has been announced but is not in production. Samples may or may not be available.

OBSELETE: TI has discontinued the production of the device.

(2) **RoHS:** TI defines "RoHS" to mean semiconductor products that are compliant with the current EU RoHS requirements for all 10 RoHS substances, including the requirement that RoHS substance do not exceed 0.1% by weight in homogeneous materials. Where designed to be soldered at high temperatures, "RoHS" products are suitable for use in specified lead-free processes. TI may reference these types of products as "Pb-Free".

RoHS Exempt: TI defines "RoHS Exempt" to mean products that contain lead but are compliant with EU RoHS pursuant to a specific EU RoHS exemption.

Green: TI defines "Green" to mean the content of Chlorine (Cl) and Bromine (Br) based flame retardants meet JS709B low halogen requirements of <=100ppm threshold. Antimony trioxide based flame retardants must also meet the <=1000ppm threshold requirement.

(3) MSL, Peak Temp. - The Moisture Sensitivity Level rating according to the JEDEC industry standard classifications, and peak solder temperature.

(4) There may be additional marking, which relates to the logo, the lot trace code information, or the environmental category on the device.

⁽⁵⁾ Multiple Device Markings will be inside parentheses. Only one Device Marking contained in parentheses and separated by a "-" will appear on a device. If a line is indented then it is a continuation of the previous line and the two combined represent the entire Device Marking for that device.

⁽⁶⁾ Lead/Ball Finish - Orderable Devices may have multiple material finish options. Finish options are separated by a vertical ruled line. Lead/Ball Finish values may wrap to two lines if the finish value exceeds the maximum column width.

Important Information and Disclaimer:The information provided on this page represents TI's knowledge and belief as of the date that it is provided. TI bases its knowledge and belief on information provided by third parties, and makes no representation or warranty as to the accuracy of such information. Efforts are underway to better integrate information from third parties. TI has taken and continues to take reasonable steps to provide representative and accurate information but may not have conducted destructive testing or chemical analysis on incoming materials and chemicals. TI and TI suppliers consider certain information to be proprietary, and thus CAS numbers and other limited information may not be available for release.

In no event shall TI's liability arising out of such information exceed the total purchase price of the TI part(s) at issue in this document sold by TI to Customer on an annual basis.

TAPE AND REEL INFORMATION

QUADRANT ASSIGNMENTS FOR PIN 1 ORIENTATION IN TAPE

*All dimensions are nominal

Device	Package Type	Package Drawing	Pins	SPQ	Reel Diameter (mm)	Reel Width W1 (mm)	A0 (mm)	B0 (mm)	K0 (mm)	P1 (mm)	W (mm)	Pin1 Quadrant
LMC6062AIMX/NOPB	SOIC	D	8	2500	330.0	12.4	6.5	5.4	2.0	8.0	12.0	Q1
LMC6062IMX/NOPB	SOIC	D	8	2500	330.0	12.4	6.5	5.4	2.0	8.0	12.0	Q1

TAPE AND REEL BOX DIMENSIONS



*All dimensions are nominal

Device	Package Type	Package Drawing	Pins	SPQ	Length (mm)	Width (mm)	Height (mm)
LMC6062AIMX/NOPB	SOIC	D	8	2500	367.0	367.0	35.0
LMC6062IMX/NOPB	SOIC	D	8	2500	367.0	367.0	35.0

P (R-PDIP-T8)

PLASTIC DUAL-IN-LINE PACKAGE



- NOTES:
- A. All linear dimensions are in inches (millimeters).
 - B. This drawing is subject to change without notice.
 - C. Falls within JEDEC MS-001 variation BA.



D0008A

PACKAGE OUTLINE

SOIC - 1.75 mm max height

SMALL OUTLINE INTEGRATED CIRCUIT



4214825/C 02/2019

NOTES:

- Linear dimensions are in inches [millimeters]. Dimensions in parenthesis are for reference only. Controlling dimensions are in inches. Dimensioning and tolerancing per ASME Y14.5M.
- This drawing is subject to change without notice.
- This dimension does not include mold flash, protrusions, or gate burrs. Mold flash, protrusions, or gate burrs shall not exceed $.006$ [0.15] per side.
- This dimension does not include interlead flash.
- Reference JEDEC registration MS-012, variation AA.

EXAMPLE BOARD LAYOUT

D0008A

SOIC - 1.75 mm max height

SMALL OUTLINE INTEGRATED CIRCUIT



LAND PATTERN EXAMPLE
 EXPOSED METAL SHOWN
 SCALE:8X



SOLDER MASK DETAILS

4214825/C 02/2019

NOTES: (continued)

6. Publication IPC-7351 may have alternate designs.

7. Solder mask tolerances between and around signal pads can vary based on board fabrication site.

EXAMPLE STENCIL DESIGN

D0008A

SOIC - 1.75 mm max height

SMALL OUTLINE INTEGRATED CIRCUIT



SOLDER PASTE EXAMPLE
BASED ON .005 INCH [0.125 MM] THICK STENCIL
SCALE:8X

4214825/C 02/2019

NOTES: (continued)

8. Laser cutting apertures with trapezoidal walls and rounded corners may offer better paste release. IPC-7525 may have alternate design recommendations.
9. Board assembly site may have different recommendations for stencil design.

IMPORTANT NOTICE AND DISCLAIMER

TI PROVIDES TECHNICAL AND RELIABILITY DATA (INCLUDING DATASHEETS), DESIGN RESOURCES (INCLUDING REFERENCE DESIGNS), APPLICATION OR OTHER DESIGN ADVICE, WEB TOOLS, SAFETY INFORMATION, AND OTHER RESOURCES "AS IS" AND WITH ALL FAULTS, AND DISCLAIMS ALL WARRANTIES, EXPRESS AND IMPLIED, INCLUDING WITHOUT LIMITATION ANY IMPLIED WARRANTIES OF MERCHANTABILITY, FITNESS FOR A PARTICULAR PURPOSE OR NON-INFRINGEMENT OF THIRD PARTY INTELLECTUAL PROPERTY RIGHTS.

These resources are intended for skilled developers designing with TI products. You are solely responsible for (1) selecting the appropriate TI products for your application, (2) designing, validating and testing your application, and (3) ensuring your application meets applicable standards, and any other safety, security, or other requirements. These resources are subject to change without notice. TI grants you permission to use these resources only for development of an application that uses the TI products described in the resource. Other reproduction and display of these resources is prohibited. No license is granted to any other TI intellectual property right or to any third party intellectual property right. TI disclaims responsibility for, and you will fully indemnify TI and its representatives against, any claims, damages, costs, losses, and liabilities arising out of your use of these resources.

TI's products are provided subject to TI's Terms of Sale (www.ti.com/legal/termsofsale.html) or other applicable terms available either on ti.com or provided in conjunction with such TI products. TI's provision of these resources does not expand or otherwise alter TI's applicable warranties or warranty disclaimers for TI products.

Mailing Address: Texas Instruments, Post Office Box 655303, Dallas, Texas 75265
Copyright © 2019, Texas Instruments Incorporated

Looking for pricing, stock, or lifecycle information?

Click below to explore more details on WIN SOURCE:

 [View LMC6062IN/NOPB on WIN SOURCE](#)

 [Texas Instruments](#) Information

Optimize Your Supply Chain with WIN SOURCE Solutions

-  Global Sourcing Solution
-  Obsolete Management
-  Cost Control Management
-  Shortage Management
-  Alternative Solution
-  Excess Inventory Management