

500 mA, μ Cap Ultra-Low Dropout Regulator with High PSRR

Features

- Ultra-Low Dropout Voltage: 200 mV @ 500 mA
- Input Voltage Range: 2.5V to 5.5V
- Output Voltage:
 - Adjustable: $V_{REF} = 1.25V$
 - Fixed: 1.3V, 1.8V, 1.85V, 2.5V, 2.6V, 2.7V, 2.8V, 2.85V, 2.9V, 3.0V, 3.3V
- Stable with Low ESR Ceramic Output Capacitor
- Low Output Noise: 40 μV_{RMS} (10 Hz to 100 kHz Bandwidth)
- Low Ground Current: 90 μA Typical
- High PSRR, up to 70 dB @ 1 kHz
- Fast Turn-On Time: 40 μs Typical
- High Output Accuracy:
 - $\pm 1.0\%$ Initial Accuracy
 - $\pm 2.0\%$ Over Temperature
- Thermal-Shutdown Protection
- Current-Limit Protection
- Logic-Controlled Enable Input Pin
- Available Packages:
 - 2 mm x 2 mm DFN, 500 mA Continuous
 - SOT23-5, 500 mA Peak

General Description

The MIC5319 is a high performance, 500 mA LDO regulator, with high PSRR and very low noise, with low ground current.

Ideal for battery-operated applications, the MIC5319 features 1% accuracy, very low dropout voltage (typically 200 mV @ 500 mA), and low ground current at light load (typically 90 μA). Equipped with a logic-compatible enable pin, the MIC5319 can be set into a zero-off-mode current state, typically drawing only 0.5 μA current when disabled.

The MIC5319 is a μ Cap design operating with very small ceramic output capacitors for stability, thereby reducing required board space and component cost.

The MIC5319 is available in fixed-output voltages and adjustable output versions in the compact 2 mm x 2 mm DFN lead-less package or the thin SOT23-5 package.

Applications

- Cellular Phones
- PDAs
- Fiber Optic Modules
- Portable Electronics
- Notebook PCs
- Audio Codec Power Supplies

Package Types



MIC5319

Typical Application Circuit



Functional Block Diagrams



1.0 ELECTRICAL CHARACTERISTICS

Absolute Maximum Ratings †

Supply Input Voltage (V_{IN})	0V to +6V
Enable Input Voltage (V_{EN})	0V to +6V
Power Dissipation (P_D) (Note 1)	Internally Limited
ESD Rating (Note 2)	3 kV, HBM

Operating Ratings ‡

Supply Input Voltage (V_{IN})	+2.5V to +5.5V
Enable Input Voltage (V_{EN})	0V to V_{IN}

† **Notice:** Stresses above those listed under “Absolute Maximum Ratings” may cause permanent damage to the device. This is a stress rating only and functional operation of the device at those or any other conditions above those indicated in the operational sections of this specification is not intended. Exposure to maximum rating conditions for extended periods may affect device reliability.

‡ **Notice:** The device is not guaranteed to function outside its operating ratings.

Note 1: The maximum allowable power dissipation of any T_A (ambient temperature) is $P_{D(MAX)} = (T_{J(MAX)} - T_A)/\theta_{JA}$. Exceeding the maximum allowable power dissipation will result in excessive die temperature, and the regulator may go into thermal shutdown.

2: Devices are ESD sensitive. Handling precautions recommended.

MIC5319

TABLE 1-1: ELECTRICAL CHARACTERISTICS

Electrical Characteristics: $V_{IN} = V_{OUT} + 1.0V$; $C_{OUT} = 2.2 \mu F$; $I_{OUT} = 100 \mu A$; $T_A = +25^\circ C$, **bold** values are available for the $-40^\circ C$ to $+125^\circ C$ junction temperature range, unless otherwise noted. (Note 1)

Parameter	Symbol	Min.	Typ.	Max.	Units	Conditions
Output Voltage Accuracy	ΔV_{OUT}	-1.0	—	1.0	%	Variation from nominal V_{OUT}
		-2.0	—	2.0		Variation from nominal V_{OUT} , $I_{OUT} = 100 \mu A$ to 500 mA
Feedback Voltage (Adj. Option)	V_{ADJ}	1.2375	1.25	1.2625	V	—
		1.225	1.25	1.275		
Line Regulation	$\frac{\Delta V_{OUT}}{V_{OUT} \times \Delta V_{IN}}$	—	0.04	0.3	%/V	$V_{IN} = V_{OUT} + 1V$ to +5.5V
Load Regulation (Note 2)	$\frac{\Delta V_{OUT}}{V_{OUT}}$	—	0.1	0.5	%	$I_L = 100 \mu A$ to 500 mA
Dropout Voltage (Note 3, Note 4)	V_{DO}	—	20	40	mV	$I_{OUT} = 50$ mA
		—	200	400		$I_{OUT} = 500$ mA
Ground Pin Current (Note 5)	I_{GND}	—	90	150	μA	$I_{OUT} = 0$ mA to 500 mA
Ground Pin Current in Shutdown Mode	I_{SHDN}	—	0.5	—	μA	$V_{EN} \leq 0.2V$
Power Supply Ripple Rejection	PSRR	—	70	—	dB	f = up to 1 kHz; $C_{OUT} = 2.2 \mu F$ ceramic; $C_{BYP} = 0.1 \mu F$
		—	60	—	dB	f = 10 kHz; $C_{OUT} = 2.2 \mu F$ ceramic; $C_{BYP} = 0.1 \mu F$
Current Limit	I_{LIMIT}	600	700	—	mA	$V_{OUT} = 0V$
Output Voltage Noise	e_N	—	40	—	μV_{RMS}	$C_{OUT} = 2.2 \mu F$; $C_{BYP} = 0.1 \mu F$; 10 Hz to 100 kHz
Turn-On Time	t_{ON}	—	40	100	μs	$C_{OUT} = 2.2 \mu F$; $C_{BYP} = 0.1 \mu F$
Enable Input Voltage	V_{ENABLE}	—	—	0.2	V	Logic Low (Regulator Shutdown)
		1.2	—	—		Logic High (Regulator Enabled)
Enable Input Current	I_{ENABLE}	—	0.01	1	μA	$V_{IL} = \leq 0.2V$ (Regulator Shutdown)
		—	0.01	1		$V_{IH} = \geq 1.0V$ (Regulator Shutdown)

Note 1: Specification for packaged product only.

2: Regulation is measured at constant junction temperature using low duty cycle pulse testing.

3: Dropout voltage is defined as the input-to-output differential at which the output voltage drops 2% below its nominal V_{OUT} . For outputs below 2.5V, dropout voltage spec does not apply, as the part is limited by minimum V_{IN} spec of 2.5V. There may be some typical dropout degradation at $V_{OUT} < 3V$.

4: For Adjustable option, $V_{OUT} = 3V$ for dropout specification.

5: Ground pin current is the regulator quiescent current. The total current drawn from the supply is the sum of the load current plus the ground pin current.

TEMPERATURE SPECIFICATIONS (Note 1)

Parameters	Sym.	Min.	Typ.	Max.	Units	Conditions
Temperature Ranges						
Junction Operating Temperature Range	T_J	-40	—	+125	°C	—
Storage Temperature Range	T_S	-65	—	+150	°C	—
Lead Temperature	—	—	—	+260	°C	Soldering, 5s
Package Thermal Resistances						
Thermal Resistance DFN-6	θ_{JA}	—	93	—	°C/W	—
Thermal Resistance Thin SOT23-5	θ_{JA}	—	235	—	°C/W	—

Note 1: The maximum allowable power dissipation is a function of ambient temperature, the maximum allowable junction temperature and the thermal resistance from junction to air (i.e., T_A , T_J , θ_{JA}). Exceeding the maximum allowable power dissipation will cause the device operating junction temperature to exceed the maximum +125°C rating. Sustained junction temperatures above +125°C can impact the device reliability.

MIC5319

2.0 TYPICAL PERFORMANCE CURVES

Note: The graphs and tables provided following this note are a statistical summary based on a limited number of samples and are provided for informational purposes only. The performance characteristics listed herein are not tested or guaranteed. In some graphs or tables, the data presented may be outside the specified operating range (e.g., outside specified power supply range) and therefore outside the warranted range.

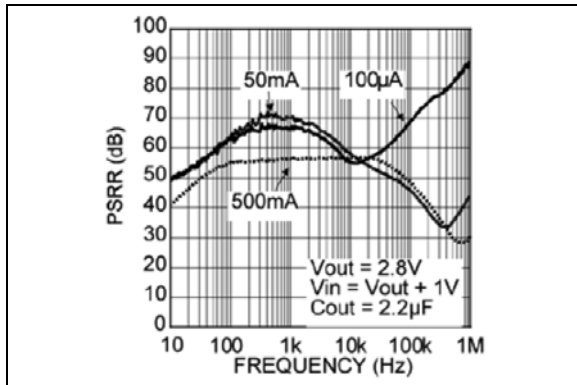

FIGURE 2-1: PSRR (Bypass Pin Capacitor = 0.1 μF).

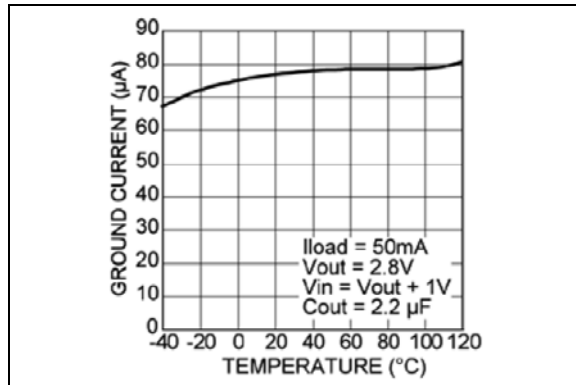

FIGURE 2-4: Ground Current vs. Temperature.

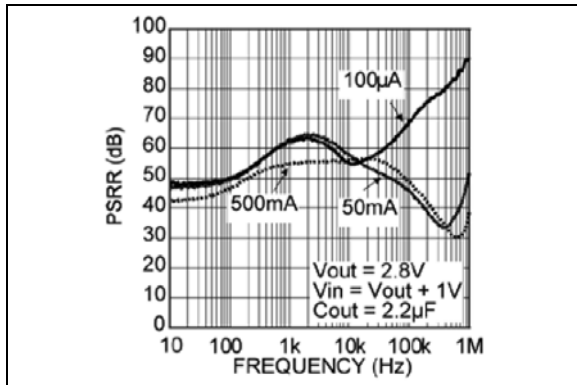

FIGURE 2-2: PSRR (Bypass Pin Capacitor = 0.01 μF).

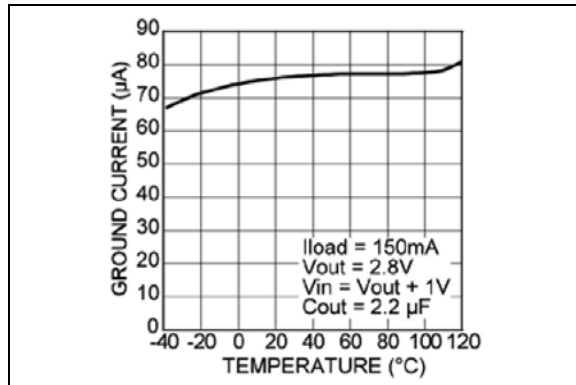

FIGURE 2-5: Ground Current vs. Temperature.

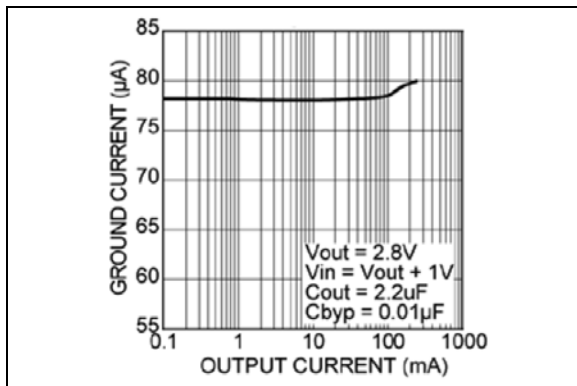

FIGURE 2-3: Ground Current vs. Output Current.

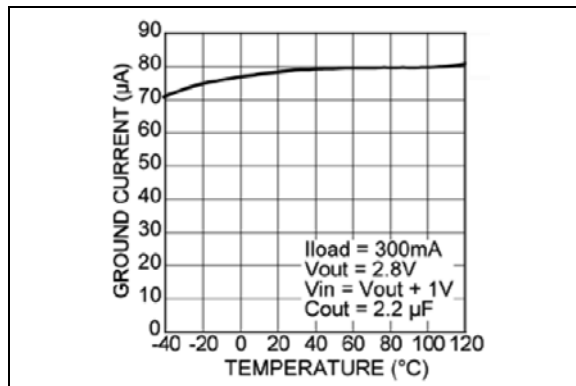

FIGURE 2-6: Ground Current vs. Temperature.

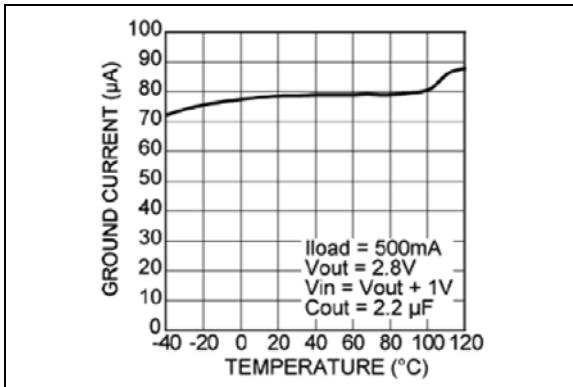

FIGURE 2-7: Ground Current vs. Temperature.



FIGURE 2-10: Ground Current vs. Input Voltage.

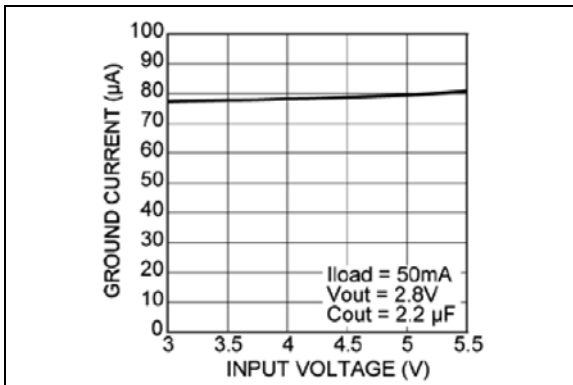

FIGURE 2-8: Ground Current vs. Input Voltage.



FIGURE 2-11: Dropout Characteristics.

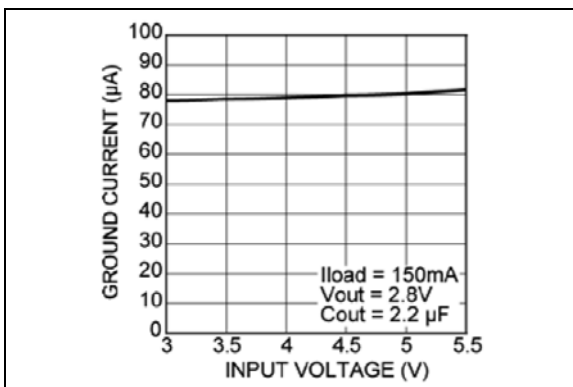

FIGURE 2-9: Ground Current vs. Input Voltage.



FIGURE 2-12: Dropout Voltage vs. Temperature.



FIGURE 2-13: Dropout Voltage vs. Temperature.



FIGURE 2-16: Short-Circuit Current vs. Input Voltage.



FIGURE 2-14: Dropout Voltage vs. Temperature.



FIGURE 2-17: Output Voltage vs. Temperature.



FIGURE 2-15: Dropout Voltage vs. Load Current.



FIGURE 2-18: Enable Threshold vs. Temperature.

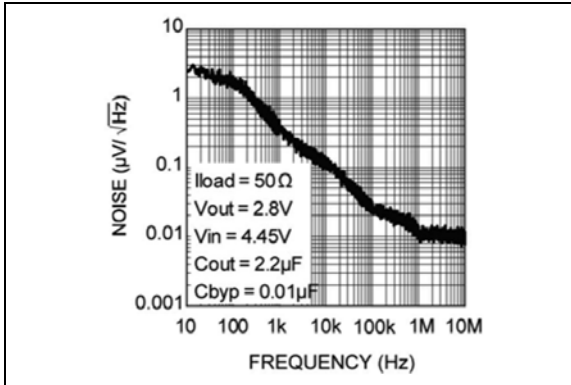

FIGURE 2-19: Output Noise Spectral Density.

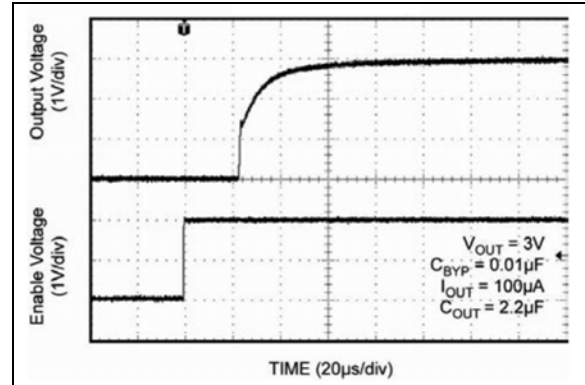

FIGURE 2-22: Enable Pin Delay (3.0V Fixed Output Version).

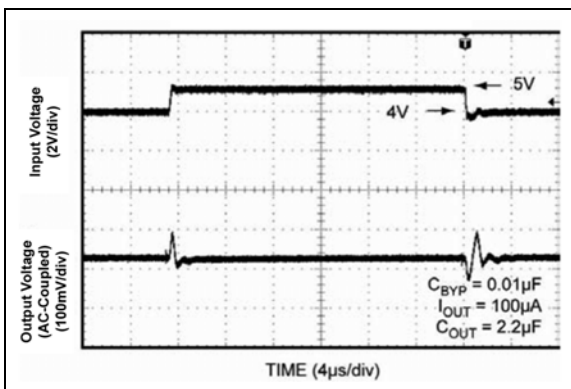

FIGURE 2-20: Line Transient Response (3.0V Fixed Output Version).

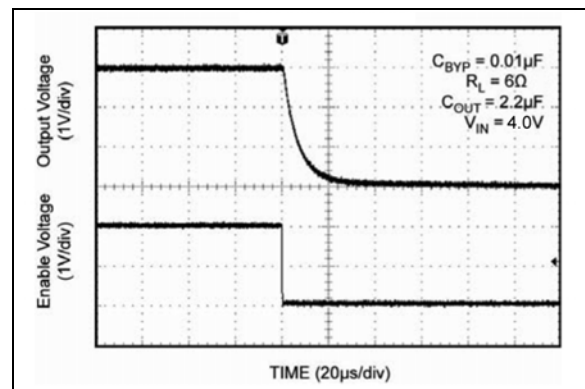

FIGURE 2-23: Shutdown Delay (3.0V Fixed Output Version).

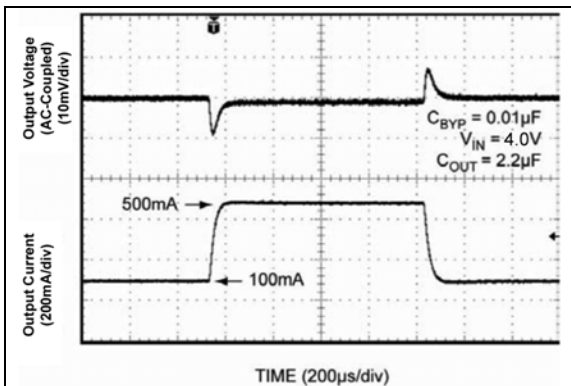

FIGURE 2-21: Load Transient Response (3.0V Fixed Output Version).

MIC5319

3.0 PIN DESCRIPTIONS

The descriptions of the pins are listed in [Table 3-1](#).

TABLE 3-1: PIN FUNCTION TABLE

Pin Number DFN-6, Fixed	Pin Number DFN-6, Adj.	Pin Number SOT23-5	Pin Name	Description
1	1	3	EN	Enable Input: Active-High. High = Regulator ON, Low = Regulator OFF. Do not leave floating.
2	2	2	GND	Ground.
3	3	1	VIN	Input Voltage.
4	4	5	VOUT	Output Voltage.
—	5	—	ADJ	Adjustable Input: Connect to the external resistor voltage divider network to set the desired output voltage.
5	—	—	NC	Not connected for the DFN fixed output voltage version.
6	6	4	BYP	Reference Bypass: Connect external 0.1 μ F to GND for reduced output noise. May be left open.
EP	EP	—	EP	Exposed Pad connected to ground internally. Must be connected to the ground plane of the application board for optimal heat dissipation.

4.0 APPLICATION INFORMATION

4.1 Enable/Shutdown

The MIC5319 features an active-high enable pin that allows the regulator to be disabled. Forcing the enable pin low disables the regulator and sends it into a “zero” off-mode current state. In this state, the current consumed by the regulator is typically only 0.5 μ A. Forcing the enable pin high enables the output voltage. The active-high enable pin uses CMOS technology and the enable pin cannot be left floating, as this may cause an undetermined state on the output.

4.2 Input Capacitor

The MIC5319 is a high-performance, high bandwidth device. Therefore, it requires a well-bypassed input supply for optimal performance. A minimum 1 μ F capacitor is required from the input-to-ground to provide stability. Low-ESR ceramic capacitors provide optimal performance at a minimum of space. Additional high-frequency capacitors, such as small-valued NPO dielectric-type capacitors, help filter out high-frequency noise and are good design practice in any RF-based circuit.

4.3 Output Capacitor

The MIC5319 requires an output capacitor of 2.2 μ F or greater to maintain stability. The design is optimized for use with low-ESR ceramic chip capacitors. High ESR capacitors may cause high-frequency oscillation. The output capacitor can be increased, but performance has been optimized for a 2.2 μ F ceramic output capacitor and does not improve significantly with larger capacitance.

X7R/X5R dielectric-type ceramic capacitors are recommended because of their temperature performance. X7R-type capacitors change capacitance by 15% over their operating temperature range and are the most stable type of ceramic capacitors. Z5U and Y5V dielectric capacitors change value by as much as 50% and 60%, respectively, over their operating temperature ranges. To use a ceramic chip capacitor with Y5V dielectric, the value must be much higher than an X7R ceramic capacitor to ensure the same minimum capacitance over the equivalent operating temperature range.

4.4 Bypass Capacitor

A capacitor can be placed from the bypass pin-to-ground to reduce output voltage noise. The capacitor bypasses the internal reference. A 0.1 μ F capacitor is recommended for applications that require low-noise outputs. The bypass capacitor can be increased, further reducing noise and improving PSRR. Turn-on time increases slightly with respect to bypass capacitance.

A unique, quick-start circuit allows the MIC5319 to drive a large capacitor on the bypass pin without significantly slowing turn-on time.

4.5 No-Load Stability

Unlike many other voltage regulators, the MIC5319 will remain stable and in regulation with no load. This is especially important in CMOS RAM keep-alive applications.

4.6 Adjustable Regulator Application

Adjustable regulators use a two-resistor divider to multiply the reference voltage and to produce the desired output voltage.

The MIC5319 output voltage can be adjusted from 1.25V to 5.5V by using two external resistors (Figure 4-1). The resistors set the output voltage based on the following equation:

EQUATION 4-1:

$$V_{OUT} = V_{REF} \left(1 + \frac{R1}{R2} \right)$$

Where:

$$V_{REF} = 1.25V$$

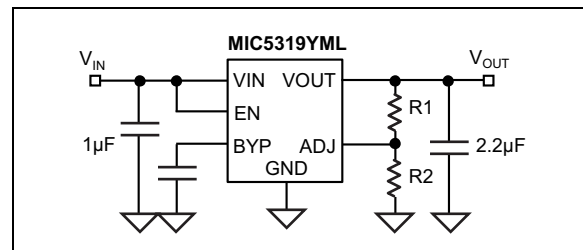

FIGURE 4-1: Adjustable Voltage Typical Application.

4.7 Thermal Considerations

The MIC5319 is designed to provide 500 mA of continuous current in a very small DFN package. Maximum ambient operating temperature can be calculated based on the output current and the voltage drop across the part. Given an input voltage of 3.3V, output voltage of 2.8V, and output current of 500 mA, the actual power dissipation of the regulator circuit can be determined using the equation:

MIC5319

EQUATION 4-2:

$$P_D = (V_{IN} - V_{OUT}) \times I_{OUT} + V_{IN} \times I_{GND}$$

Because this device is CMOS and the ground current is typically <100 μ A over the load range, the power dissipation contributed by the ground current is <1% and can be ignored for this calculation:

EQUATION 4-3:

$$P_D = (3.3V - 2.8V) \times 500mA = 0.25W$$

To determine the maximum ambient operating temperature of the package, use the junction-to-ambient thermal resistance of the device and the following basic equation:

EQUATION 4-4:

$$P_{D(MAX)} = \frac{T_{J(MAX)} - T_A}{\theta_{JA}}$$

Where:

$$T_{J(MAX)} = 125^\circ\text{C}$$

$$\theta_{JA} = 93^\circ\text{C/W (for the DFN package)}$$

Substituting 0.25W for $P_{D(MAX)}$ and solving for the ambient operating temperature will give the maximum operating conditions for the regulator circuit. The maximum power dissipation must not be exceeded for proper operation.

EQUATION 4-5:

$$0.25W = \frac{125^\circ\text{C} - T_A}{93^\circ\text{C/W}}$$

$$T_A = 101.75^\circ\text{C}$$

Therefore, a 2.8V application at 500 mA of output current can accept an ambient operating temperature of 101.75°C in a 2 mm x 2 mm DFN package. For a full discussion of heat sinking and thermal effects on voltage regulators, refer to the “Regulator Thermals” section of Microchip’s [Designing with Low-Dropout Voltage Regulators](#) handbook.

5.0 PACKAGING INFORMATION

5.1 Package Marking Information

5-Pin TSOT23*

XXXX
NNN

6-Pin DFN*

▲ XXX
NNN

Example

Z31J
689

Example

▲ 933
689

Part Number	Marking
MIC5319YML-TR	<u>9AA</u>
MIC5319-5.0YML-TR	<u>950</u>
MIC5319-5.0YD5-TR	<u>N950</u>
MIC5319-3.3YML-TR	<u>933</u>
MIC5319-3.3YD5-TR	<u>N933</u>
MIC5319-3.0YML-TR	<u>930</u>
MIC5319-3.0YD5-TR	<u>N930</u>
MIC5319-2.9YML-TR	<u>N929</u>
MIC5319-2.8YML-TR	<u>928</u>
MIC5319-2.8YD5-TR	<u>N928</u>
MIC5319-2.85YML-TR	<u>92J</u>
MIC5319-2.7YML-TR	<u>927</u>
MIC5319-2.7YD5-TR	<u>N927</u>
MIC5319-2.6YML-TR	<u>926</u>
MIC5319-2.6YD5-TX	<u>N926</u>
MIC5319-2.6YD5-TR	<u>N926</u>
MIC5319-2.5YML-TR	<u>925</u>
MIC5319-2.5YD5-TX	<u>N925</u>
MIC5319-2.5YD5-TR	<u>N925</u>
MIC5319-1.8YML-TR	<u>918</u>
MIC5319-1.8YD5-TX	<u>N918</u>
MIC5319-1.8YD5-TR	<u>N918</u>
MIC5319-1.85YML-TR	<u>91J</u>
MIC5319-1.85YD5-TX	<u>N91J</u>
MIC5319-1.85YD5-TR	<u>N91J</u>
MIC5319-1.3HYML-TR	<u>13H</u>
MIC5319-1.3HYD5-TR	<u>N13H</u>

Legend: XX...X Product code or customer-specific information
 Y Year code (last digit of calendar year)
 YY Year code (last 2 digits of calendar year)
 WW Week code (week of January 1 is week '01')
 NNN Alphanumeric traceability code
 (e3) Pb-free JEDEC® designator for Matte Tin (Sn)
 * This package is Pb-free. The Pb-free JEDEC designator (e3) can be found on the outer packaging for this package.
 ●, ▲, ▼ Pin one index is identified by a dot, delta up, or delta down (triangle mark).

Note: In the event the full Microchip part number cannot be marked on one line, it will be carried over to the next line, thus limiting the number of available characters for customer-specific information. Package may or may not include the corporate logo.
 Underbar () and/or Overbar () symbol may not be to scale.

MIC5319

5-Lead TSOT Package Outline and Recommended Land Pattern

TITLE

5 LEAD TSOT PACKAGE OUTLINE & RECOMMENDED LAND PATTERN

DRAWING #	TSOT-5LD-PL-1	UNIT	MM
------------------	---------------	-------------	----

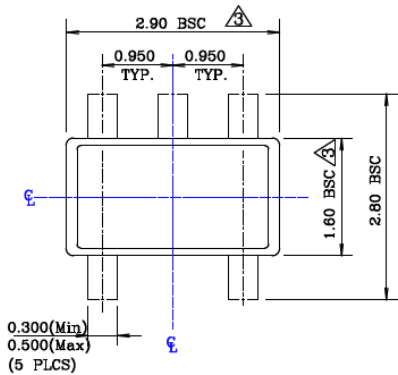

TOP VIEW
NOTES : 3, 6

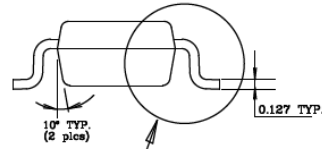

END VIEW
NOTES : 2, 4, 6

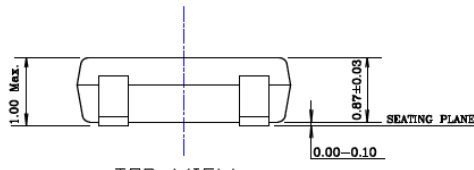

TOP VIEW
NOTES : 4, 6

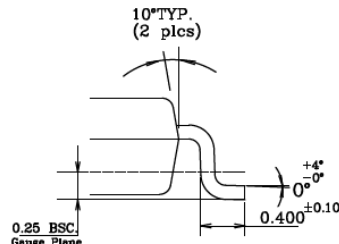

DETAIL "A"

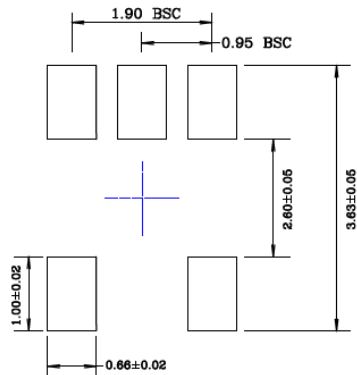

RECOMMENDED LAND PATTERN

NOTE:

1. Dimensions and tolerances are as per ANSI Y14.5M, 1994.
2. Die is facing up for mold. Die is facing down for trim/form, ie. reverse trim/form.
3. Dimensions are exclusive of mold flash and gate burr.
4. The footlength measuring is based on the gauge plane method.
5. All specification comply to Jedec Spec MO193 Issue C.
6. All dimensions are in millimeters.

Note: For the most current package drawings, please see the Microchip Packaging Specification located at <http://www.microchip.com/packaging>.

6-Lead DFN 2 mm x 2 mm Package Outline and Recommended Land Pattern

TITLE

6 LEAD DFN 2x2mm PACKAGE OUTLINE & RECOMMENDED LAND PATTERN

DRAWING #	DFN22-6LD-PL-1	UNIT	MM
-----------	----------------	------	----



TOP VIEW
NOTE: 1, 2, 3

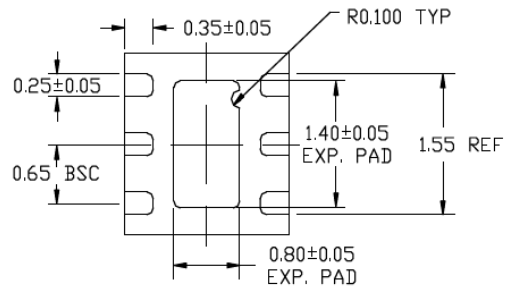

BOTTOM VIEW
NOTE: 1, 2, 3

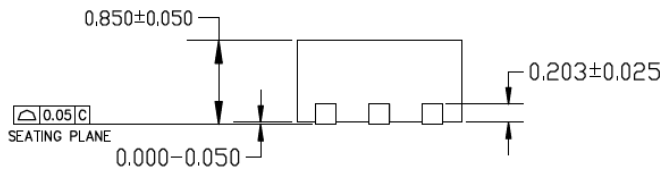

END VIEW
NOTE: 1, 2, 3

NOTE:

1. MAX PACKAGE WARPAGE IS 0.05 MM
2. MAX ALLOWABLE BURR IS 0.076MM IN ALL DIRECTIONS
3. PIN #1 IS ON TOP WILL BE LASER MARKED
4. RED CIRCLE IN LAND PATTERN INDICATE THERMAL VIA. SIZE SHOULD BE 0.30-0.3M IN DIAMETER AND SHOULD BE CONNECTED TO GND FOR MAX THERMAL PERFORMANCE
5. GREEN RECTANGLES (SHADED AREA) indicate SOLDER STENCIL OPENING ON EXPOSED PAD AREA. SIZE SHOULD BE 0.60x0.40 MM IN SIZE, 0.20 MM SPACING.

Note: For the most current package drawings, please see the Microchip Packaging Specification located at <http://www.microchip.com/packaging>.

MIC5319

POD-Land Pattern drawing # DFN22-6LD-PL-1

RECOMMENDED LAND PATTERN

NOTE: 4,5

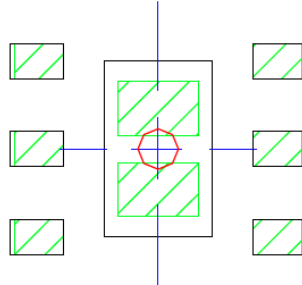

STACKED-UP

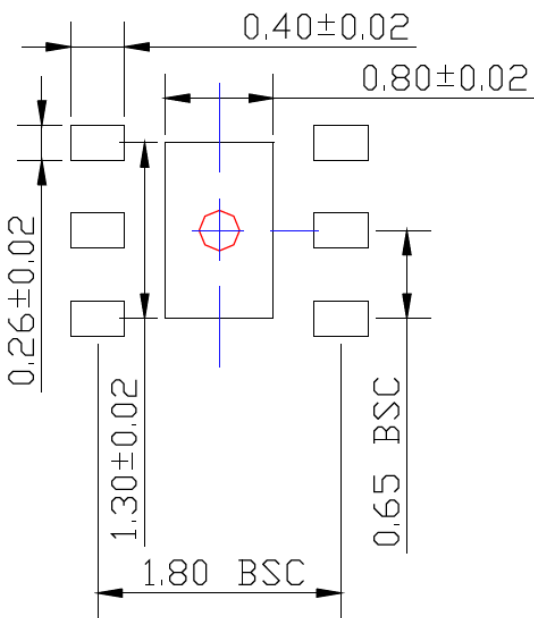

EXPOSED METAL TRACE

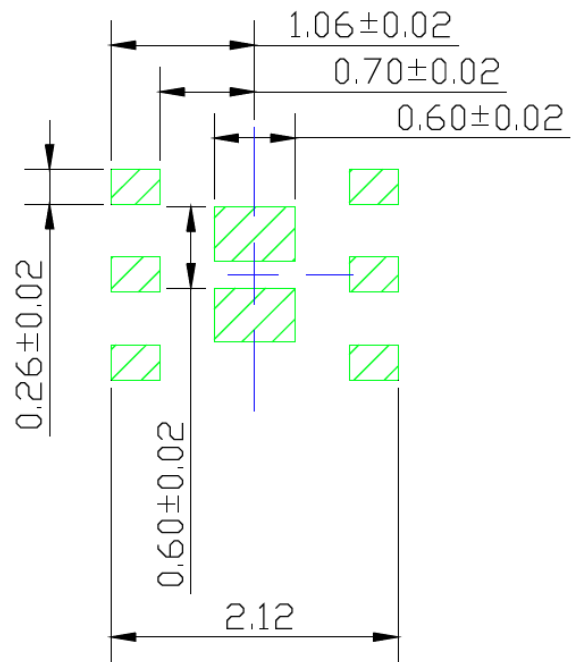

SOLDER STENCIL OPENING

Note: For the most current package drawings, please see the Microchip Packaging Specification located at <http://www.microchip.com/packaging>.

APPENDIX A: REVISION HISTORY

Revision A (October 2017)

- Converted Micrel document MIC5319 to Microchip data sheet DS20005876A.
- Minor text changes throughout.

Revision B (February 2018)

- Replaced the incorrect DFN 2x2 package drawing with the correct version.

MIC5319

NOTES:

PRODUCT IDENTIFICATION SYSTEM

To order or obtain information, e.g., on pricing or delivery, contact your local Microchip representative or sales office.

<u>PART NO.</u>	<u>-X.X</u>	<u>X</u>	<u>XX</u>	<u>-XX</u>
Device	Output Voltage	Junction Temp. Range	Package	Media Type
Device:	MIC5319:	500 mA μ Cap Ultra-Low Dropout High PSRR LDO Regulator		
Voltage:	<blank>= Adjustable 1.3H = 1.375V 1.8 = 1.8V 1.85 = 1.85V 2.5 = 2.5V 2.6 = 2.6V 2.7 = 2.7V 2.8 = 2.8V 2.85 = 2.85V (DFN Only) 2.9 = 2.9V (DFN Only) 3.0 = 3.0V 3.3 = 3.3V 5.0 = 5.0V			
Junction Temperature Range:	Y =	-40°C to +125°C RoHS-Compliant		
Package:	D5 =	5-Lead TSOT23		
	ML =	6-Lead 2 mm x 2 mm DFN		
Media Type:	TX =	3,000/Reel (with reversed Pin 1; D5 only)		
	TR =	3,000/Reel (D5)		
	TR =	5,000/Reel (ML)		
Examples:				
a) MIC5319-1.3HYML-TR: 500 mA μ Cap Ultra-Low Dropout High PSRR LDO Regulator, 1.375V Output Voltage, -40°C to +125°C, 6-Lead DFN, 5,000/Reel				
b) MIC5319YD5-TX: 500 mA μ Cap Ultra-Low Dropout High PSRR LDO Regulator, Adjustable Output Voltage, -40°C to +125°C, 5-Lead TSOT23, 3,000/Reel w/ Reversed Pin 1				
c) MIC5319-2.7YML-TR: 500 mA μ Cap Ultra-Low Dropout High PSRR LDO Regulator, 2.7V Output Voltage, -40°C to +125°C, 6-Lead DFN, 5,000/Reel				
d) MIC5319-3.0YD5-TR: 500 mA μ Cap Ultra-Low Dropout High PSRR LDO Regulator, 3.0V Output Voltage, -40°C to +125°C, 5-Lead TSOT23, 3,000/Reel				
e) MIC5319-2.85YML-TR: 500 mA μ Cap Ultra-Low Dropout High PSRR LDO Regulator, 2.85V Output Voltage, -40°C to +125°C, 6-Lead DFN, 5,000/Reel				
f) MIC5319-5.0YD5-TX: 500 mA μ Cap Ultra-Low Dropout High PSRR LDO Regulator, 5.0V Output Voltage, -40°C to +125°C, 5-Lead TSOT23, 3,000/Reel w/ Reversed Pin 1				
Note 1: Tape and Reel identifier only appears in the catalog part number description. This identifier is used for ordering purposes and is not printed on the device package. Check with your Microchip Sales Office for package availability with the Tape and Reel option.				

MIC5319

NOTES:

Note the following details of the code protection feature on Microchip devices:

- Microchip products meet the specification contained in their particular Microchip Data Sheet.
- Microchip believes that its family of products is one of the most secure families of its kind on the market today, when used in the intended manner and under normal conditions.
- There are dishonest and possibly illegal methods used to breach the code protection feature. All of these methods, to our knowledge, require using the Microchip products in a manner outside the operating specifications contained in Microchip's Data Sheets. Most likely, the person doing so is engaged in theft of intellectual property.
- Microchip is willing to work with the customer who is concerned about the integrity of their code.
- Neither Microchip nor any other semiconductor manufacturer can guarantee the security of their code. Code protection does not mean that we are guaranteeing the product as “unbreakable.”

Code protection is constantly evolving. We at Microchip are committed to continuously improving the code protection features of our products. Attempts to break Microchip's code protection feature may be a violation of the Digital Millennium Copyright Act. If such acts allow unauthorized access to your software or other copyrighted work, you may have a right to sue for relief under that Act.

Information contained in this publication regarding device applications and the like is provided only for your convenience and may be superseded by updates. It is your responsibility to ensure that your application meets with your specifications. MICROCHIP MAKES NO REPRESENTATIONS OR WARRANTIES OF ANY KIND WHETHER EXPRESS OR IMPLIED, WRITTEN OR ORAL, STATUTORY OR OTHERWISE, RELATED TO THE INFORMATION, INCLUDING BUT NOT LIMITED TO ITS CONDITION, QUALITY, PERFORMANCE, MERCHANTABILITY OR FITNESS FOR PURPOSE. Microchip disclaims all liability arising from this information and its use. Use of Microchip devices in life support and/or safety applications is entirely at the buyer's risk, and the buyer agrees to defend, indemnify and hold harmless Microchip from any and all damages, claims, suits, or expenses resulting from such use. No licenses are conveyed, implicitly or otherwise, under any Microchip intellectual property rights unless otherwise stated.

Microchip received ISO/TS-16949:2009 certification for its worldwide headquarters, design and wafer fabrication facilities in Chandler and Tempe, Arizona; Gresham, Oregon and design centers in California and India. The Company's quality system processes and procedures are for its PIC® MCUs and dsPIC® DSCs, KEELoQ® code hopping devices, Serial EEPROMs, microperipherals, nonvolatile memory and analog products. In addition, Microchip's quality system for the design and manufacture of development systems is ISO 9001:2000 certified.

**QUALITY MANAGEMENT SYSTEM
CERTIFIED BY DNV
= ISO/TS 16949 =**

Trademarks

The Microchip name and logo, the Microchip logo, AnyRate, AVR, AVR logo, AVR Freaks, BeaconThings, BitCloud, CryptoMemory, CryptoRF, dsPIC, FlashFlex, flexPWR, Heldo, JukeBlox, KEELoQ, KEELoQ logo, Kleer, LANCheck, LINK MD, maXStylus, maXTouch, MediaLB, megaAVR, MOST, MOST logo, MPLAB, OptoLyzer, PIC, picoPower, PICSTART, PIC32 logo, Prochip Designer, QTouch, RightTouch, SAM-BA, SpyNIC, SST, SST Logo, SuperFlash, tinyAVR, UNI/O, and XMEGA are registered trademarks of Microchip Technology Incorporated in the U.S.A. and other countries.

ClockWorks, The Embedded Control Solutions Company, EtherSynch, Hyper Speed Control, HyperLight Load, IntelliMOS, mTouch, Precision Edge, and Quiet-Wire are registered trademarks of Microchip Technology Incorporated in the U.S.A.

Adjacent Key Suppression, AKS, Analog-for-the-Digital Age, Any Capacitor, AnyIn, AnyOut, BodyCom, chipKIT, chipKIT logo, CodeGuard, CryptoAuthentication, CryptoCompanion, CryptoController, dsPICDEM, dsPICDEM.net, Dynamic Average Matching, DAM, ECAN, EtherGREEN, In-Circuit Serial Programming, ICSP, Inter-Chip Connectivity, JitterBlocker, KleerNet, KleerNet logo, Mindi, MiWi, motorBench, MPASM, MPF, MPLAB Certified logo, MPLIB, MPLINK, MultiTRAK, NetDetach, Omniscient Code Generation, PICDEM, PICDEM.net, PICKit, PICtail, PureSilicon, QMatrix, RightTouch logo, REAL ICE, Ripple Blocker, SAM-ICE, Serial Quad I/O, SMART-I.S., SQI, SuperSwitcher, SuperSwitcher II, Total Endurance, TSHARC, USBCheck, VariSense, ViewSpan, WiperLock, Wireless DNA, and ZENA are trademarks of Microchip Technology Incorporated in the U.S.A. and other countries.

SQTP is a service mark of Microchip Technology Incorporated in the U.S.A.

Silicon Storage Technology is a registered trademark of Microchip Technology Inc. in other countries.

GestIC is a registered trademark of Microchip Technology Germany II GmbH & Co. KG, a subsidiary of Microchip Technology Inc., in other countries.

All other trademarks mentioned herein are property of their respective companies.

© 2018, Microchip Technology Incorporated, All Rights Reserved.
ISBN: 978-1-5224-2705-6



MICROCHIP

Worldwide Sales and Service

AMERICAS

Corporate Office
2355 West Chandler Blvd.
Chandler, AZ 85224-6199
Tel: 480-792-7200
Fax: 480-792-7277
Technical Support:
<http://www.microchip.com/support>
Web Address:
www.microchip.com

Atlanta
Duluth, GA
Tel: 678-957-9614
Fax: 678-957-1455

Austin, TX
Tel: 512-257-3370

Boston
Westborough, MA
Tel: 774-760-0087
Fax: 774-760-0088

Chicago
Itasca, IL
Tel: 630-285-0071
Fax: 630-285-0075

Dallas
Addison, TX
Tel: 972-818-7423
Fax: 972-818-2924

Detroit
Novi, MI
Tel: 248-848-4000

Houston, TX
Tel: 281-894-5983

Indianapolis
Noblesville, IN
Tel: 317-773-8323
Fax: 317-773-5453
Tel: 317-536-2380

Los Angeles
Mission Viejo, CA
Tel: 949-462-9523
Fax: 949-462-9608
Tel: 951-273-7800

Raleigh, NC
Tel: 919-844-7510

New York, NY
Tel: 631-435-6000

San Jose, CA
Tel: 408-735-9110
Tel: 408-436-4270

Canada - Toronto
Tel: 905-695-1980
Fax: 905-695-2078

ASIA/PACIFIC

Australia - Sydney
Tel: 61-2-9868-6733

China - Beijing
Tel: 86-10-8569-7000

China - Chengdu
Tel: 86-28-8665-5511

China - Chongqing
Tel: 86-23-8980-9588

China - Dongguan
Tel: 86-769-8702-9880

China - Guangzhou
Tel: 86-20-8755-8029

China - Hangzhou
Tel: 86-571-8792-8115

China - Hong Kong SAR
Tel: 852-2943-5100

China - Nanjing
Tel: 86-25-8473-2460

China - Qingdao
Tel: 86-532-8502-7355

China - Shanghai
Tel: 86-21-3326-8000

China - Shenyang
Tel: 86-24-2334-2829

China - Shenzhen
Tel: 86-755-8864-2200

China - Suzhou
Tel: 86-186-6233-1526

China - Wuhan
Tel: 86-27-5980-5300

China - Xian
Tel: 86-29-8833-7252

China - Xiamen
Tel: 86-592-2388138

China - Zhuhai
Tel: 86-756-3210040

ASIA/PACIFIC

India - Bangalore
Tel: 91-80-3090-4444

India - New Delhi
Tel: 91-11-4160-8631

India - Pune
Tel: 91-20-4121-0141

Japan - Osaka
Tel: 81-6-6152-7160

Japan - Tokyo
Tel: 81-3-6880-3770

Korea - Daegu
Tel: 82-53-744-4301

Korea - Seoul
Tel: 82-2-554-7200

Malaysia - Kuala Lumpur
Tel: 60-3-7651-7906

Malaysia - Penang
Tel: 60-4-227-8870

Philippines - Manila
Tel: 63-2-634-9065

Singapore
Tel: 65-6334-8870

Taiwan - Hsin Chu
Tel: 886-3-577-8366

Taiwan - Kaohsiung
Tel: 886-7-213-7830

Taiwan - Taipei
Tel: 886-2-2508-8600

Thailand - Bangkok
Tel: 66-2-694-1351

Vietnam - Ho Chi Minh
Tel: 84-28-5448-2100

EUROPE

Austria - Wels
Tel: 43-7242-2244-39
Fax: 43-7242-2244-393

Denmark - Copenhagen
Tel: 45-4450-2828
Fax: 45-4485-2829

Finland - Espoo
Tel: 358-9-4520-820

France - Paris
Tel: 33-1-69-53-63-20
Fax: 33-1-69-30-90-79

Germany - Garching
Tel: 49-8931-9700

Germany - Haan
Tel: 49-2129-3766400

Germany - Heilbronn
Tel: 49-7131-67-3636

Germany - Karlsruhe
Tel: 49-721-625370

Germany - Munich
Tel: 49-89-627-144-0
Fax: 49-89-627-144-44

Germany - Rosenheim
Tel: 49-8031-354-560

Israel - Ra'anana
Tel: 972-9-744-7705

Italy - Milan
Tel: 39-0331-742611
Fax: 39-0331-466781

Italy - Padova
Tel: 39-049-7625286

Netherlands - Drunen
Tel: 31-416-690399
Fax: 31-416-690340

Norway - Trondheim
Tel: 47-7289-7561

Poland - Warsaw
Tel: 48-22-3325737

Romania - Bucharest
Tel: 40-21-407-87-50

Spain - Madrid
Tel: 34-91-708-08-90
Fax: 34-91-708-08-91

Sweden - Gothenberg
Tel: 46-31-704-60-40

Sweden - Stockholm
Tel: 46-8-5090-4654

UK - Wokingham
Tel: 44-118-921-5800
Fax: 44-118-921-5820

Looking for pricing, stock, or lifecycle information?

Click below to explore more details on WIN SOURCE:

- ⊖ [View MIC5319-1.8BD5 on WIN SOURCE](#)
- ⊖ [Microchip Technology Information](#)

Optimize Your Supply Chain with WIN SOURCE Solutions

- ✓ Global Sourcing Solution
- ✓ Obsolete Management
- ✓ Cost Control Management
- ✓ Shortage Management
- ✓ Alternative Solution
- ✓ Excess Inventory Management