

FEATURES

- Low quiescent current at 250 μ A max
- Laser trimmed to high accuracy
2.5 V \pm 5 mV max (AN, AR grades)
- Trimmed temperature coefficient
20 ppm/ $^{\circ}$ C max (AN, AR grades)
- Low noise at 8 μ V p-p from 0.1 Hz to 10 Hz
- 250 nV/ $\sqrt{\text{Hz}}$ wideband
- Temperature output pin (N, R packages)
- Available in three package styles
8-lead PDIP, 8-lead SOIC, and 3-pin TO-92

GENERAL DESCRIPTION

The AD680 is a band gap voltage reference that provides a fixed 2.5 V output from inputs between 4.5 V and 36 V. The architecture of the AD680 enables the reference to be operated at a very low quiescent current while still realizing excellent dc characteristics and noise performance. Trimming of the high stability thin-film resistors is performed for initial accuracy and temperature coefficient, resulting in low errors over temperature.

The precision dc characteristics of the AD680 make it ideal for use as a reference for DACs that require an external precision reference. The device is also ideal for ADCs and, in general, can offer better performance than the standard on-chip references. Based upon its low quiescent current, which rivals that of many incomplete 2-terminal references, the AD680 is recommended for low power applications, such as hand-held, battery-operated equipment.

A temperature output pin is provided on the 8-lead package versions of the AD680. The temperature output pin provides an output voltage that varies linearly with temperature and allows the AD680 to be configured as a temperature transducer while providing a stable 2.5 V output.

The AD680 is available in five grades. The AD680AN is specified for operation from -40°C to $+85^{\circ}\text{C}$, while the AD680JN is specified for 0°C to 70°C operation. Both the AD680AN and AD680JN are available in 8-lead PDIP packages. The AD680AR is specified for operation from -40°C to $+85^{\circ}\text{C}$, while the AD680JR is specified for 0°C to 70°C operation. Both are available in 8-lead SOIC packages. The AD680JT is specified for 0°C to 70°C operation and is available in a 3-pin TO-92 package.

Rev. H

Information furnished by Analog Devices is believed to be accurate and reliable. However, no responsibility is assumed by Analog Devices for its use, nor for any infringements of patents or other rights of third parties that may result from its use. Specifications subject to change without notice. No license is granted by implication or otherwise under any patent or patent rights of Analog Devices. Trademarks and registered trademarks are the property of their respective owners.

CONNECTION DIAGRAMS

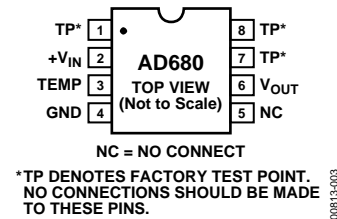

Figure 1. 8-Lead PDIP and 8-Lead SOIC Pin Configuration

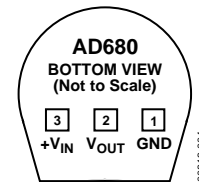

Figure 2. Connection Diagram TO-92

PRODUCT HIGHLIGHTS

1. High Accuracy.
The AD680 band gap reference operates on a very low quiescent current which rivals that of many 2-terminal references. This makes the complete, higher accuracy AD680 ideal for use in power-sensitive applications.
2. Low Errors.
Laser trimming of both initial accuracy and temperature coefficients results in low errors over temperature without the use of external components. The AD680AN and AD680AR have a maximum variation of 6.25 mV between -40°C and $+85^{\circ}\text{C}$.
3. Low Noise.
The AD680 noise is low, typically 8 μ V p-p from 0.1 Hz to 10 Hz. Spectral density is also low, typically 250 nV/ $\sqrt{\text{Hz}}$.
4. Temperature Transducer.
The temperature output pin on the 8-lead package versions enables the AD680 to be configured as a temperature transducer.
5. Low Cost.
PDIP packaging provides machine insertability, while SOIC packaging provides surface-mount capability. TO-92 packaging offers a cost-effective alternative to 2-terminal references, offering a complete solution in the same package in which 2-terminal references are usually found.

TABLE OF CONTENTS

Specifications.....	3	Load Regulation	8
Absolute Maximum Ratings.....	4	Temperature Performance.....	8
Output Protection	4	Temperature Output Pin	9
ESD Caution.....	4	Differential Temperature Transducer	9
Pin Configuration and Connection Diagram.....	5	Low Power, Low Voltage Reference for Data Converters	9
Theory of Operation	6	4.5 V Reference from a 5 V Supply	10
Applying the AD680	6	Voltage Regulator for Portable Equipment.....	10
Noise Performance	6	Outline Dimensions	11
Turn-on Time.....	7	Ordering Guide	12
Dynamic Performance.....	7		

REVISION HISTORY

8/05—Rev. G to Rev. H	
Changes to Ordering Guide	11
12/04—Rev. F to Rev. G	
Updated Format	Universal
Changes to Ordering Guide	11
5/04—Rev. E to Rev. F	
Changes to ORDERING GUIDE	3
5/03—Rev. D to Rev. E	
Changes to ORDERING GUIDE	3
Added ESD Caution	3
Changes to Figure 20.....	7
Updated OUTLINE DIMENSIONS	8
7/01—Rev. C to Rev. D	
Changes to SPECIFICATIONS.....	2
Changes to ORDERING GUIDE	3
Table I added	6

SPECIFICATIONS

$T_A = 25^\circ\text{C}$, $V_{IN} = 5\text{ V}$, unless otherwise noted. Specifications in **boldface** are tested on all production units at final electrical test. Results from these tests are used to calculate outgoing quality levels. All minimum and maximum specifications are guaranteed.

Table 1.

Parameter	AD680AN/AD680AR			AD680JN/AD680JR			AD680JT			Unit
	Min	Typ	Max	Min	Typ	Max	Min	Typ	Max	
OUTPUT VOLTAGE										
Output Voltage, V_o	2.495	2.500	2.505	2.490	2.500	2.510	2.490	2.500	2.510	V
Initial Accuracy, V_{OERR}	-5		+5	-10		+10	-10		+10	mV
	-0.20		+0.20	-0.40		+0.40	-0.40		+0.40	%
OUTPUT VOLTAGE DRIFT ¹										
0°C to 70°C		10			10	25		10	30	ppm/ $^\circ\text{C}$
-40°C to $+85^\circ\text{C}$			20		25			25		ppm/ $^\circ\text{C}$
LINE REGULATION										
$4.5\text{ V} \leq +V_{IN} \leq 15\text{ V}$			40			40			40	$\mu\text{V}/\text{V}$
(@ T_{MIN} to T_{MAX})			40			40			40	$\mu\text{V}/\text{V}$
$15\text{ V} \leq +V_{IN} \leq 36\text{ V}$			40			40			40	$\mu\text{V}/\text{V}$
(@ T_{MIN} to T_{MAX})			40			40			40	$\mu\text{V}/\text{V}$
LOAD REGULATION										
$0 < I_{OUT} < 10\text{ mA}$		80	100		80	100		80	100	$\mu\text{V}/\text{mA}$
(@ T_{MIN} to T_{MAX})		80	100		80	100		80	100	$\mu\text{V}/\text{mA}$
QUIESCENT CURRENT		195	250		195	250		195	250	μA
(@ T_{MIN} to T_{MAX})			280			280			280	μA
POWER DISSIPATION		1	1.25		1	1.25		1	1.25	mW
OUTPUT NOISE										
0.1 Hz to 10 Hz		8	10		8	10		8	10	$\mu\text{V p-p}$
Spectral Density, 100 Hz		250			250			250		$\text{nV}/\sqrt{\text{Hz}}$
CAPACITIVE LOAD			50			50			50	nF
LONG-TERM STABILITY		25			25			25		ppm/1,000 hr
SHORT-CIRCUIT CURRENT TO GROUND		25	50		25	50		25	50	mA
TEMPERATURE PIN										
Voltage Output @ 25°C	540	596	660	540	596	660				mV
Temperature Sensitivity		2			2					$\text{mV}/^\circ\text{C}$
Output Current	-5		+5	-5		+5				μA
Output Resistance		12			12					k Ω
TEMPERATURE RANGE										
Specified Performance	-40		+85	0		70	0		70	$^\circ\text{C}$
Operating Performance ²	-40		+85	-40		+85	-40		+85	$^\circ\text{C}$

¹ Maximum output voltage drift is guaranteed for all packages.

² The operating temperature range is defined as the temperature extremes at which the device will still function. Parts may deviate from their specified performance outside their specified temperature range.

ABSOLUTE MAXIMUM RATINGS

Table 2.

Parameter	Rating
V_{IN} to Ground	36 V
Power Dissipation (25°C)	500 mW
Storage Temperature	-65°C to +125°C
Lead Temperature (Soldering, 10 sec)	300°C
Package Thermal Resistance θ_{JA} (All Packages)	120°C/W

Stresses above those listed under Absolute Maximum Ratings may cause permanent damage to the device. This is a stress rating only; functional operation of the device at these or any other conditions above those indicated in the operational section of this specification is not implied. Exposure to absolute maximum rating conditions for extended periods may affect device reliability.

OUTPUT PROTECTION

Output safe for indefinite short to GND and momentary short to $-V_{IN}$.

ESD CAUTION

ESD (electrostatic discharge) sensitive device. Electrostatic charges as high as 4000 V readily accumulate on the human body and test equipment and can discharge without detection. Although this product features proprietary ESD protection circuitry, permanent damage may occur on devices subjected to high energy electrostatic discharges. Therefore, proper ESD precautions are recommended to avoid performance degradation or loss of functionality.



PIN CONFIGURATIONS AND FUNCTION DESCRIPTIONS

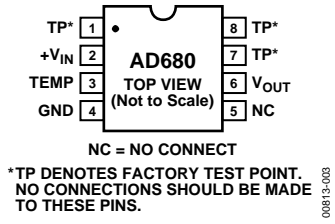

Figure 3. 8-Lead PDIP and 8-Lead SOIC Pin Configuration

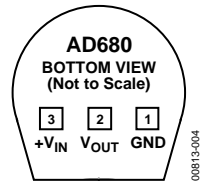

Figure 4. Connection Diagram

Table 3. Pin Function Descriptions

Pin No.	Mnemonic	Descriptions
1, 7, 8	TP	Test Point. A factory test point. No connections are made to these pins.
2	+V _{IN}	Input Voltage.
3	TEMP	Temperature Output.
4	GND	Ground.
5	NC	No Connect.
6	V _{OUT}	Output Voltage.

THEORY OF OPERATION

Band gap references are the high performance solution for low supply voltage operation. A typical precision band gap consists of a reference core and buffer amplifier. Based on a new, patented band gap reference design (Figure 5), the AD680 merges the amplifier and the core band gap function to produce a compact, complete precision reference.

Central to the device is a high gain amplifier with an intentionally large proportional to absolute temperature (PTAT) input offset. This offset is controlled by the area ratio of the amplifier input pair, Q1 and Q2, and is developed across Resistor R1. Transistor Q12's base emitter voltage has a complementary to absolute temperature (CTAT) characteristic. Resistor R2 and the parallel combination of Resistor R3 and Resistor R4 "multiply" the PTAT voltage across the R1 resistor. Trimming the R3 and R4 resistors to the proper ratio produces a temperature invariant of 2.5 V at the output. The result is an accurate, stable output voltage accomplished with a minimum number of components.

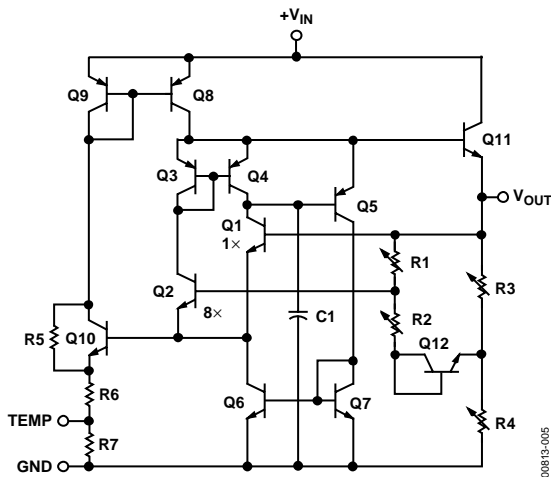

Figure 5. Schematic Diagram

APPLYING THE AD680

The AD680 is simple to use in virtually all precision reference applications. When power is applied to $+V_{IN}$ and the GND pin is tied to ground, V_{OUT} provides a 2.5 V output. The AD680 typically requires less than 250 μA of current when operating from a supply of 4.5 V to 36 V.

To operate the AD680, the $+V_{IN}$ pin must be bypassed to the GND pin with a 0.1 μF capacitor tied as close to the AD680 as possible. Although the ground current for the AD680 is small, typically 195 μA , a direct connection should be made between the AD680 GND pin and the system ground plane.

Reference outputs are frequently required to handle fast transients caused by input switching networks, commonly found in ADCs and measurement instrumentation equipment. Many of the dynamic problems associated with this situation can be minimized with a few simple techniques. Using a series resistor between the reference output and the load tends to "decouple" the reference output from the transient source, or a relatively large capacitor connected from the reference output to ground can serve as a charge storage element to absorb and deliver charge as required by the dynamic load. A 50 nF capacitor is recommended for the AD680 in this case; this is large enough to store the required charge, but small enough not to disrupt the stability of the reference.

The 8-lead PDIP and 8-lead SOIC packaged versions of the AD680 also provide a temperature output pin. The voltage on this pin is nominally 596 mV at 25°C. This pin provides an output linearly proportional to temperature with a characteristic of 2 mV/°C.

NOISE PERFORMANCE

The noise generated by the AD680 is typically less than 8 μV p-p over the 0.1 Hz to 10 Hz band. Figure 6 shows the 0.1 Hz to 10 Hz noise of a typical AD680. The noise measurement is made with a band-pass filter made of a 1-pole high-pass filter, with a corner frequency at 0.1 Hz, and a 2-pole low-pass filter, with a corner frequency at 12.6 Hz, to create a filter with a 9.922 Hz bandwidth.

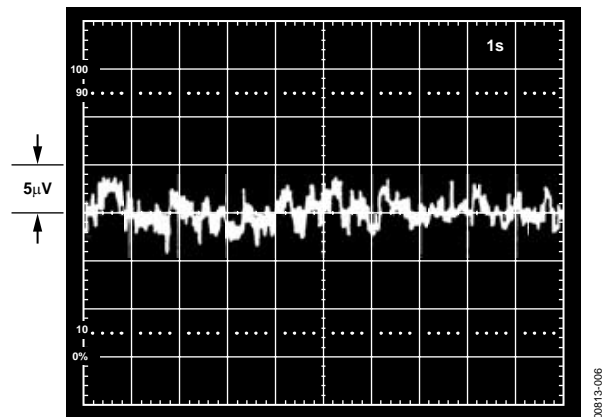

Figure 6. 0.1 Hz to 10 Hz Noise

Noise in a 300 kHz bandwidth is approximately 800 μV p-p. Figure 7 shows the broadband noise of a typical AD680.

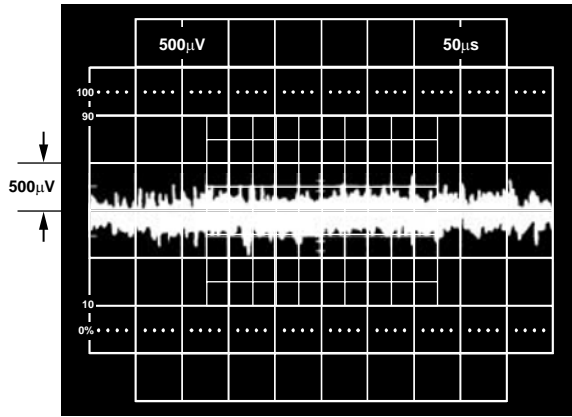

Figure 7. Broadband Noise at 300 kHz

TURN-ON TIME

Upon application of power (cold start), the time required for the output voltage to reach its final value within a specified error band is defined as the turn-on settling time. Two components normally associated with this are the time for the active circuits to settle, and the time for the thermal gradients on the chip to stabilize. The turn-on settling time of the AD680 is about 20 μs to within 0.025% of its final value, as shown in Figure 8.

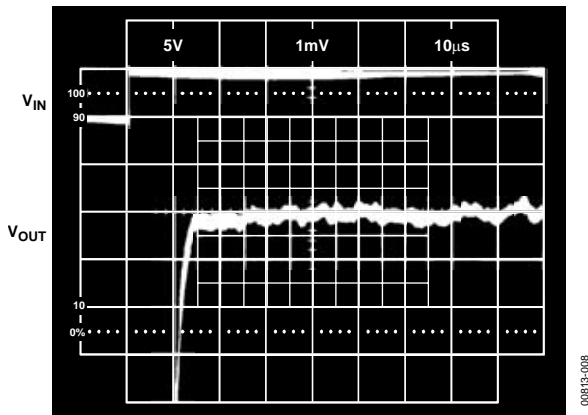

Figure 8. Turn-On Settling Time

The AD680 thermal settling characteristic benefits from its compact design. Once initial turn-on is achieved, the output linearly approaches its final value; the output is typically within 0.01% of its final value after 25 ms.

DYNAMIC PERFORMANCE

The output stage of the amplifier is designed to provide the AD680 with static and dynamic load regulation superior to less complete references. Figure 9 to Figure 11 display the characteristics of the AD680 output amplifier driving a 0 mA to 10 mA load. Longer settling times result if the reference is forced to sink any transient current.

In some applications, a varying load may be both resistive and capacitive in nature, or the load may be connected to the AD680 by a long capacitive cable.

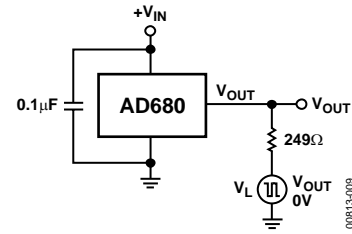

Figure 9. Transient Load Test Circuit

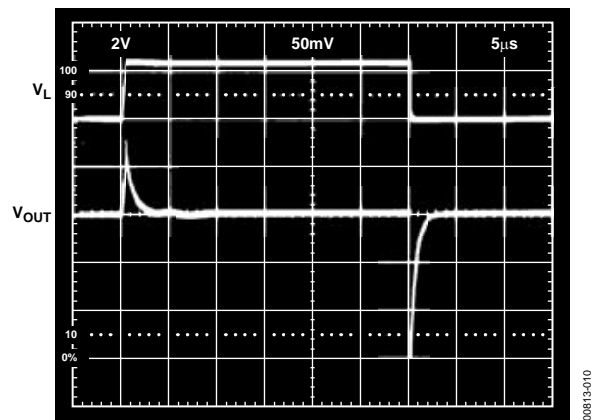

Figure 10. Large Scale Transient Response

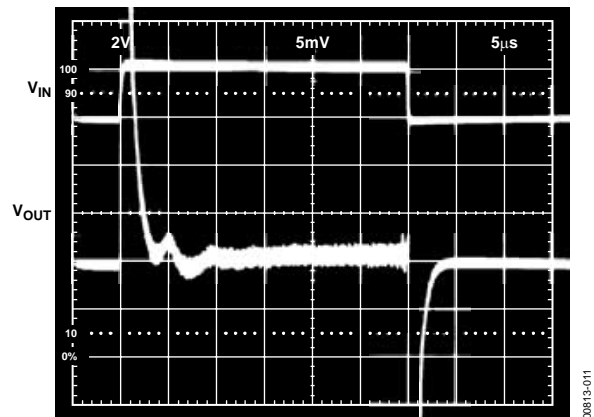

Figure 11. Fine Scale Settling for Transient Load

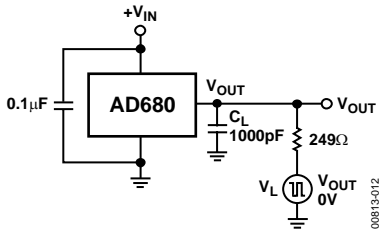

Figure 12. Capacitive Load Transient Response Test Circuit

Figure 13 displays the output amplifier characteristics driving a 1,000 pF, 0 mA to 10 mA load.

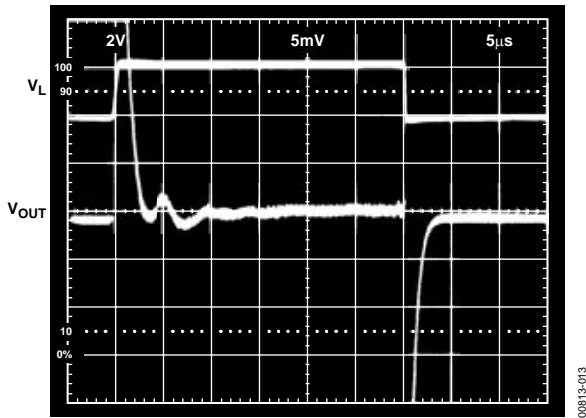

Figure 13. Output Response with Capacitive Load

LOAD REGULATION

Figure 14 depicts the load regulation characteristics of the AD680.

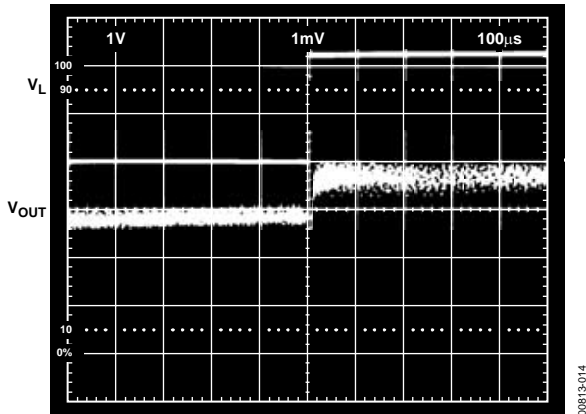

Figure 14. Typical Load Regulation Characteristics

TEMPERATURE PERFORMANCE

The AD680 is designed for reference applications where temperature performance is important. Extensive temperature testing and characterization ensure that the device's performance is maintained over the specified temperature range.

Some confusion exists in the area of defining and specifying reference voltage error over temperature. Historically, references have been characterized using a maximum deviation per degree centigrade, that is, ppm/°C. However, because of nonlinearities in temperature characteristics that originated in standard Zener references (such as "S" type characteristics), most manufacturers now use a maximum limit error band approach to specify devices. This technique involves measuring the output at three or more different temperatures to specify an output voltage error band.

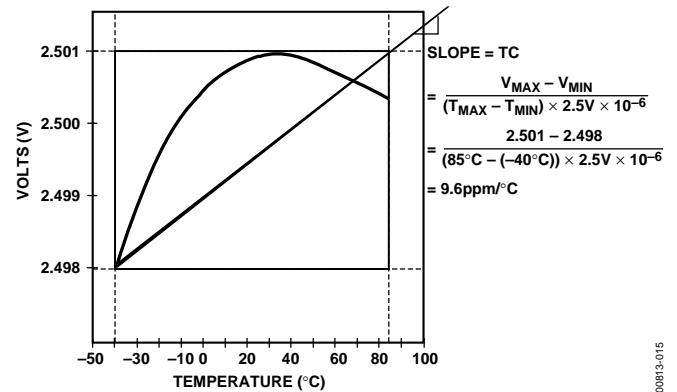

Figure 15. Typical AD680AN/AD680AR Temperature Drift

Figure 15 shows a typical output voltage drift for the AD680AN/AD680AR and illustrates the test methodology. The box in Figure 15 is bounded on the left and right sides by the operating temperature extremes, and on the top and bottom by the maximum and minimum output voltages measured over the operating temperature range.

The maximum height of the box for the appropriate temperature range and device grade is shown in Table 4. Duplication of these results requires a combination of high accuracy and stable temperature control in a test system. Evaluation of the AD680 will produce a curve similar to that in Figure 15, but output readings could vary depending upon the test equipment used.

Table 4. Maximum Output Change in mV

Device Grade	Maximum Output Change (mV)	
	0°C to 70°C	-40°C to +85°C
AD680JN/AD680JR	4.375	Not applicable
AD680JT	5.250	Not applicable
AD680AN	Not applicable	6.250

TEMPERATURE OUTPUT PIN

The 8-lead package versions of the AD680 provide a temperature output pin on Pin 3 of each device. The output of Pin 3 (TEMP) is a voltage that varies linearly with temperature. V_{TEMP} at 25°C is 596 mV, and the temperature coefficient is 2 mV/°C. Figure 16 shows the output of this pin over temperature.

The temperature pin has an output resistance of 12 kΩ and is capable of sinking or sourcing currents of up to 5 μA without disturbing the reference output. This enables the TEMP pin to be buffered by many inexpensive operational amplifiers that have bias currents below this value.

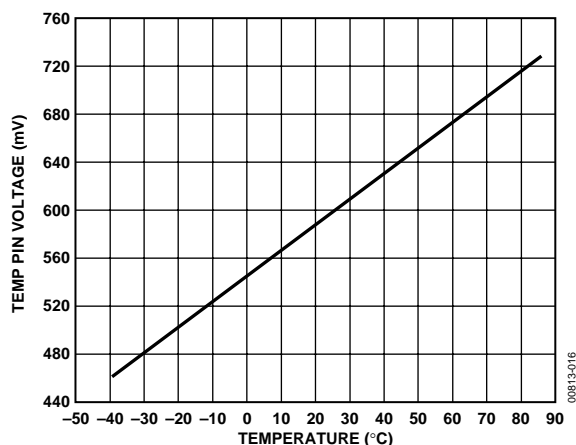

Figure 16. TEMP Pin Transfer Characteristics

DIFFERENTIAL TEMPERATURE TRANSDUCER

Figure 17 shows a differential temperature transducer that can be used to measure temperature changes in the environment of the AD680. This circuit operates from a 5 V supply. The temperature-dependent voltage from the TEMP pin of the AD680 is amplified by a factor of 5 to provide wider full-scale range and more current sourcing capability. An exact gain of 5 can be achieved by adjusting the trim potentiometer until the output varies by 10 mV/°C. To minimize resistance changes with temperature, use resistors with low temperature coefficients, such as metal film resistors.

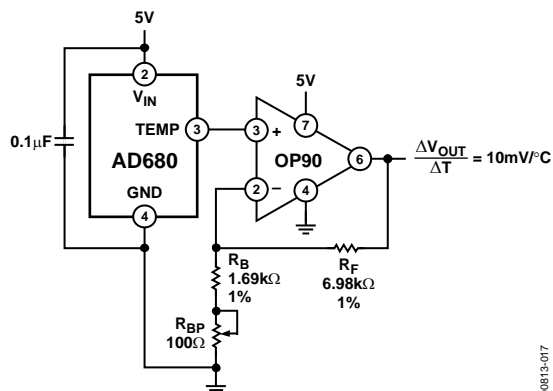

Figure 17. Differential Temperature Transducer

LOW POWER, LOW VOLTAGE REFERENCE FOR DATA CONVERTERS

The AD680 has a number of features that make it ideally suited for use with ADCs and DACs. The low supply voltage required makes it possible to use the AD680 with today's converters that run on 5 V supplies without having to add a higher supply voltage for the reference. The low quiescent current (195 μA), combined with the completeness and accuracy of the AD680, make it ideal for low power applications, such as hand-held, battery-operated meters.

The AD7701 is an ADC that is well-suited for the AD680. Figure 18 shows the AD680 used as the reference for this converter. The AD7701 is a 16-bit ADC with on-chip digital filtering intended for the measurement of wide dynamic range and low frequency signals, such as those representing chemical, physical, or biological processes. It contains a charge balancing ($\Sigma-\Delta$) ADC, a calibration microcontroller with on-chip static RAM, a clock oscillator, and a serial communications port.

This entire circuit runs on ±5 V supplies. The power dissipation of the AD7701 is typically 25 mW and, when combined with the power dissipation of the AD680 (1 mW), the entire circuit consumes just 26 mW of power.

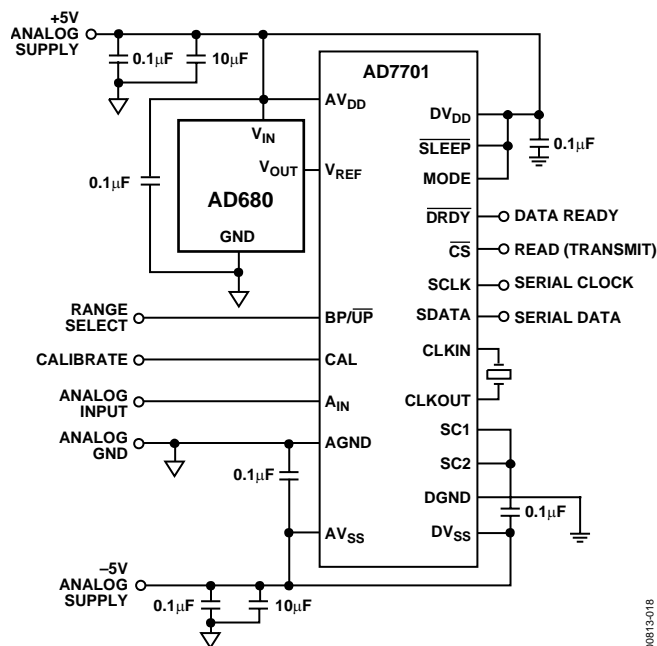
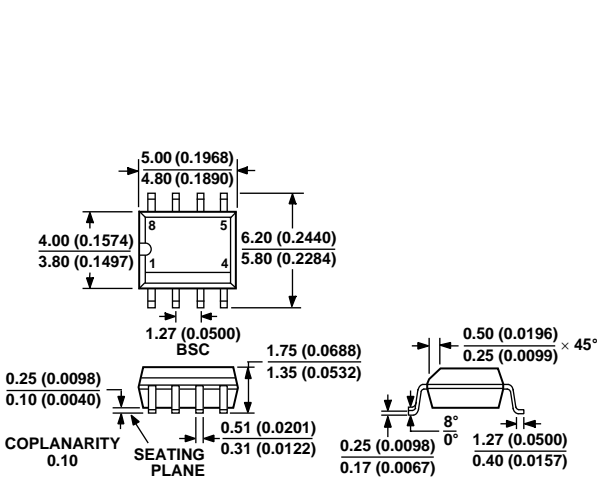

Figure 18. Low Power, Low Voltage Supply Reference for the AD7701 16-Bit ADC

OUTLINE DIMENSIONS



COMPLIANT TO JEDEC STANDARDS MS-012AA
 CONTROLLING DIMENSIONS ARE IN MILLIMETERS; INCH DIMENSIONS (IN PARENTHESES) ARE ROUNDED-OFF MILLIMETER EQUIVALENTS FOR REFERENCE ONLY AND ARE NOT APPROPRIATE FOR USE IN DESIGN

Figure 21. 8-Lead Standard Small Outline Package [SOIC] Narrow Body (R-8)
 Dimensions show in millimeters and (inches)

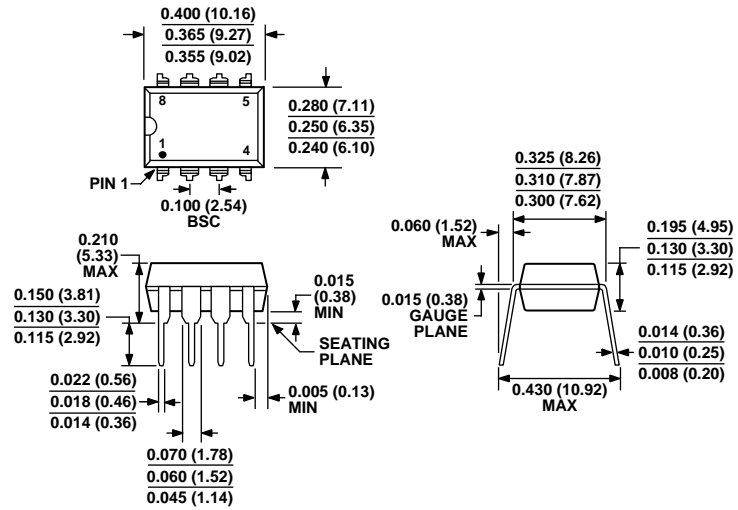

COMPLIANT TO JEDEC STANDARDS MS-001-BA
 CONTROLLING DIMENSIONS ARE IN INCHES; MILLIMETER DIMENSIONS (IN PARENTHESES) ARE ROUNDED-OFF INCH EQUIVALENTS FOR REFERENCE ONLY AND ARE NOT APPROPRIATE FOR USE IN DESIGN. CORNER LEADS MAY BE CONFIGURED AS WHOLE OR HALF LEADS.

Figure 22. 8-Lead Plastic Dual In-Line Package [PDIP] Narrow Body (N-8)
 Dimensions shown in inches and (millimeters)

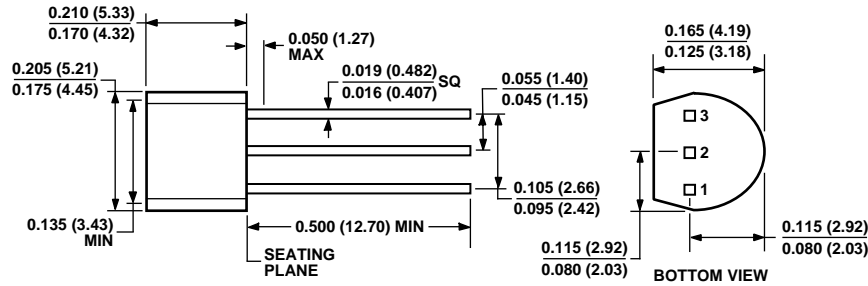

COMPLIANT TO JEDEC STANDARDS TO-226AA
 CONTROLLING DIMENSIONS ARE IN INCHES; MILLIMETER DIMENSIONS (IN PARENTHESES) ARE ROUNDED-OFF EQUIVALENTS FOR REFERENCE ONLY AND ARE NOT APPROPRIATE FOR USE IN DESIGN

Figure 23. 3-Pin Plastic Header-Style Package [TO-92] (T-3)
 Dimensions shown in inches and (millimeters)

AD680

ORDERING GUIDE

Model	Output Voltage V _o (V)	Initial Accuracy		Temperature Coefficient (ppm/°C)	Package Description	Package Option	Parts per Reel	Temperature Range (°C)
		(mV)	(%)					
AD680AR	2.5	5	0.20	20	SOIC	R-8		-40 to +85
AD680AR-REEL	2.5	5	0.20	20	SOIC	R-8	2,500	-40 to +85
AD680AR-REEL7	2.5	5	0.20	20	SOIC	R-8	1,000	-40 to +85
AD680ARZ ¹	2.5	5	0.20	20	SOIC	R-8		-40 to +85
AD680ARZ-REEL7 ¹	2.5	5	0.20	20	SOIC	R-8	1,000	-40 to +85
AD680JR	2.5	10	0.40	25	SOIC	R-8		0 to 70
AD680JR-REEL7	2.5	10	0.40	25	SOIC	R-8	1,000	0 to 70
AD680JRZ ¹	2.5	10	0.40	25	SOIC	R-8		0 to 70
AD680JRZ-REEL7 ¹	2.5	10	0.40	25	SOIC	R-8	1,000	0 to 70
AD680AN	2.5	5	0.20	20	PDIP	N-8		-40 to +85
AD680ANZ ¹	2.5	5	0.20	20	PDIP	N-8		-40 to +85
AD680JN	2.5	10	0.40	25	PDIP	N-8		0 to 70
AD680JNZ ¹	2.5	10	0.40	25	PDIP	N-8		0 to 70
AD680JT	2.5	10	0.40	30	TO-92	T-3		0 to 70
AD680JTZ ¹	2.5	10	0.40	30	TO-92	T-3		0 to 70

¹ Z = Pb-free part.

Looking for pricing, stock, or lifecycle information?

Click below to explore more details on WIN SOURCE:

 [View AD680JT on WIN SOURCE](#)

 [Analog Devices Inc. Information](#)

Optimize Your Supply Chain with WIN SOURCE Solutions

-  Global Sourcing Solution
-  Obsolete Management
-  Cost Control Management
-  Shortage Management
-  Alternative Solution
-  Excess Inventory Management