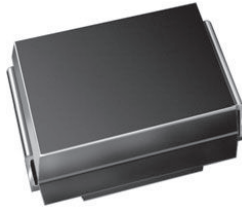


Surface Mount Glass Passivated Rectifier


SMB (DO-214AA)
DESIGN SUPPORT TOOLS
[click logo to get started](#)


| PRIMARY CHARACTERISTICS | |
|--|------------------------------------|
| $I_{F(AV)}$ | 2.0 A |
| V_{RRM} | 200 V, 400 V, 600 V, 800 V, 1000 V |
| I_{FSM} | 50 A |
| I_R | 5.0 μ A |
| V_F at $I_F = 2.0$ A ($T_A = 125$ °C) | 0.90 V |
| T_J max. | 150 °C |
| Package | SMB (DO-214AA) |
| Circuit configuration | Single |

FEATURES

- Low profile package
- Ideal for automated placement
- Glass passivated pellet chip junction
- Low forward voltage drop
- Low leakage current
- High forward surge capability
- Meets MSL level 1, per J-STD-020, LF maximum peak of 260 °C
- Material categorization: for definitions of compliance please see www.vishay.com/doc?99912


RoHS
COMPLIANT

TYPICAL APPLICATIONS

For use in general purpose rectification of power supplies, inverters, converters, and freewheeling diodes for consumer, and telecommunication.

MECHANICAL DATA

Case: SMB (DO-214AA)

Molding compound meets UL 94 V-0 flammability rating
Base P/N-E3 - RoHS-compliant, commercial grade

Terminals: matte tin plated leads, solderable per J-STD-002 and JESD 22-B102

E3 suffix meets JESD 201 class 2 whisker test

Polarity: color band denotes cathode end

| MAXIMUM RATINGS ($T_A = 25$ °C unless otherwise noted) | | | | | | | |
|--|----------------------------|-------------|------|------|------|------|------|
| PARAMETER | SYMBOL | CS2D | CS2G | CS2J | CS2K | CS2M | UNIT |
| Device marking code | | D | G | J | K | M | |
| Maximum repetitive peak reverse voltage | V_{RRM} | 200 | 400 | 600 | 800 | 1000 | V |
| Average forward rectified current | $I_{F(AV)}$ ⁽¹⁾ | 1.6 | | | | | A |
| | $I_{F(AV)}$ ⁽²⁾ | 2.0 | | | | | |
| Peak forward surge current 8.3 ms single half sine-wave superimposed on rated load | I_{FSM} | 50 | | | | | A |
| Operating junction and storage temperature range | T_J, T_{STG} | -55 to +150 | | | | | °C |

Notes

- (1) Free air, mounted on recommended copper pad area
- (2) Mounted on 8 mm x 8 mm copper pad areas

| ELECTRICAL CHARACTERISTICS ($T_A = 25\text{ }^\circ\text{C}$ unless otherwise noted) | | | | | | |
|--|--|-----------------------------------|-------------|------|------|---------------|
| PARAMETER | TEST CONDITIONS | | SYMBOL | TYP. | MAX. | UNIT |
| Maximum instantaneous forward voltage | $I_F = 1.0\text{ A}$ | $T_A = 25\text{ }^\circ\text{C}$ | $V_F^{(1)}$ | 0.92 | - | V |
| | $I_F = 2.0\text{ A}$ | | | 0.99 | 1.2 | |
| | $I_F = 1.0\text{ A}$ | $T_A = 125\text{ }^\circ\text{C}$ | | 0.81 | - | |
| | $I_F = 2.0\text{ A}$ | | | 0.90 | 0.98 | |
| Maximum DC reverse current at rated DC blocking voltage | Rated V_R | $T_A = 25\text{ }^\circ\text{C}$ | $I_R^{(2)}$ | - | 5.0 | μA |
| | | $T_A = 125\text{ }^\circ\text{C}$ | | - | 350 | |
| Typical reverse recovery time | $I_F = 0.5\text{ A}, I_R = 1.0\text{ A}, I_{rr} = 0.25\text{ A}$ | | t_{rr} | 2.1 | - | μs |
| Typical junction capacitance | 4.0 V, 1 MHz | | C_J | 12 | - | pF |

Notes

- (1) Pulse test: 300 μs pulse width, 1 % duty cycle
 (2) Pulse test: pulse width $\leq 40\text{ ms}$

| THERMAL CHARACTERISTICS ($T_A = 25\text{ }^\circ\text{C}$ unless otherwise noted) | | | | | | | |
|---|-----------------------|------|------|------|------|------|--------------------|
| PARAMETER | SYMBOL | CS2D | CS2G | CS2J | CS2K | CS2M | UNIT |
| Typical thermal resistance | $R_{\theta JA}^{(1)}$ | 97 | | | | | $^\circ\text{C/W}$ |
| | $R_{\theta JM}^{(2)}$ | 20 | | | | | |

Notes

- (1) Free air, mounted on recommended copper pad area; thermal resistance $R_{\theta JA}$ - junction-to-ambient
 (2) Mounted on 8 mm x 8 mm copper pad areas, $R_{\theta JM}$ - junction-to-mount at the terminal

| ORDERING INFORMATION (Example) | | | | |
|---------------------------------------|-----------------|------------------------|---------------|------------------------------------|
| PREFERRED P/N | UNIT WEIGHT (g) | PREFERRED PACKAGE CODE | BASE QUANTITY | DELIVERY MODE |
| CS2J-E3/I | 0.096 | I | 3200 | 13" diameter plastic tape and reel |

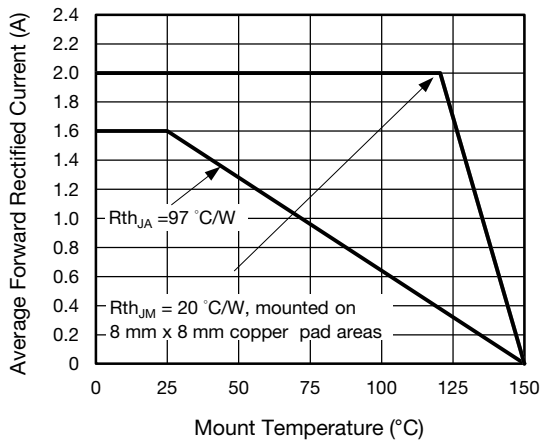
RATINGS AND CHARACTERISTICS CURVES ($T_A = 25\text{ }^\circ\text{C}$ unless otherwise noted)


Fig. 1 - Maximum Forward Current Derating Curve

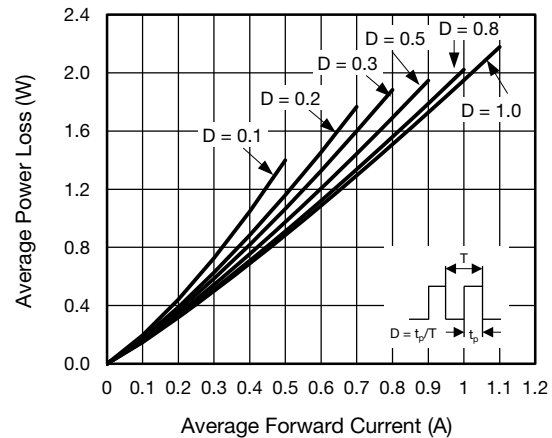


Fig. 2 - Maximum Non-Repetitive Peak Forward Surge Current

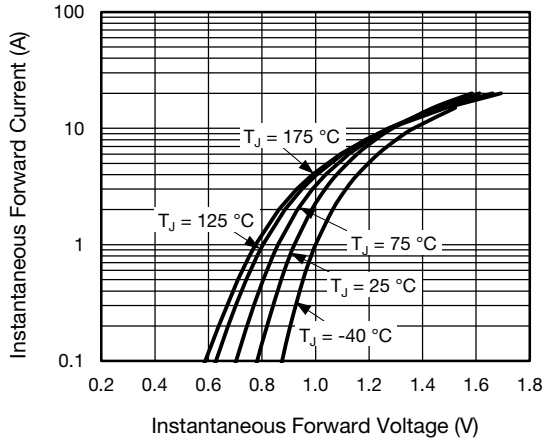


Fig. 3 - Typical Instantaneous Forward Characteristics

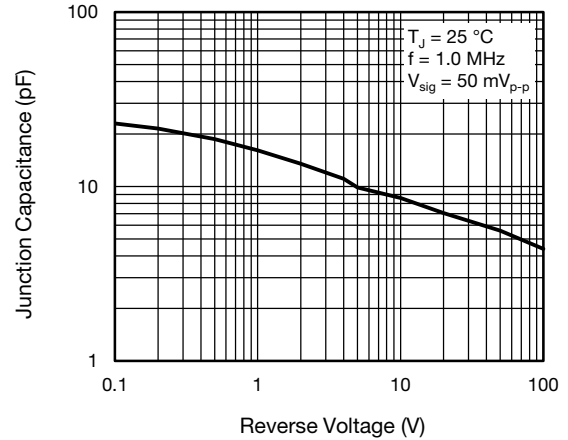


Fig. 5 - Typical Junction Capacitance

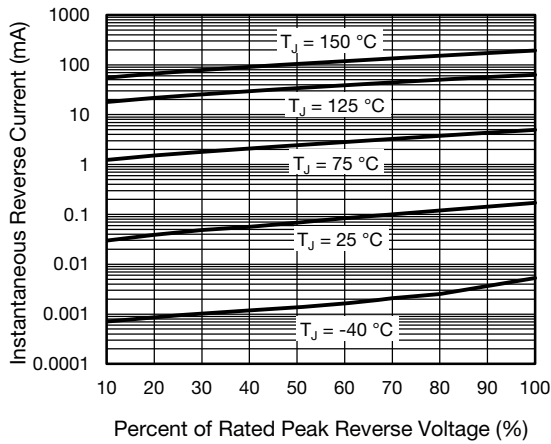


Fig. 4 - Typical Reverse Leakage Characteristics

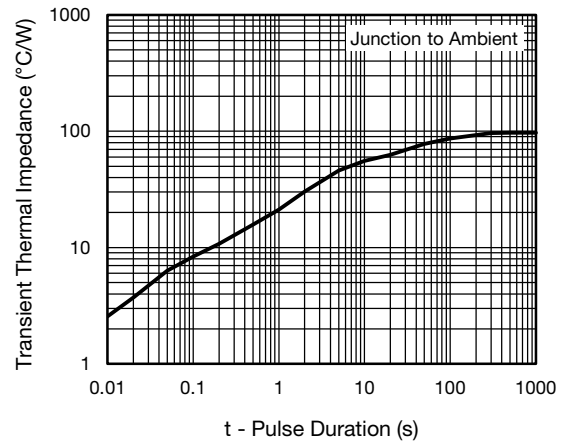
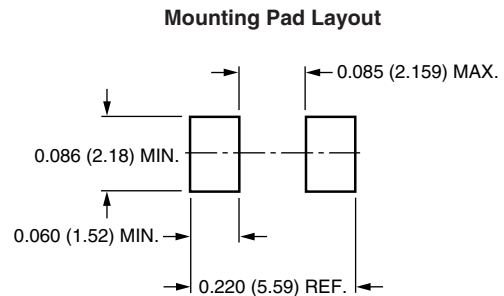
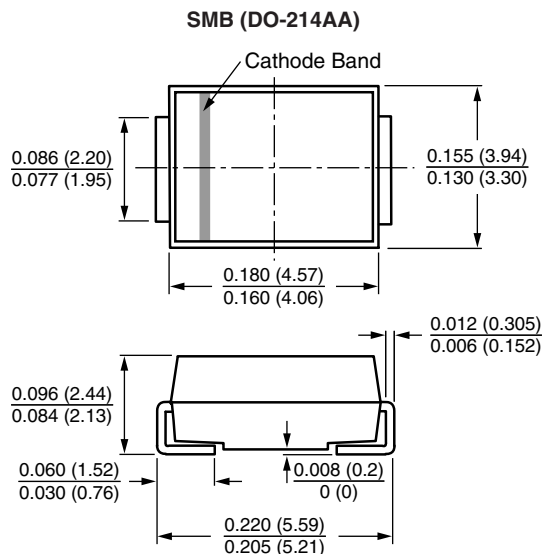


Fig. 6 - Typical Transient Thermal Impedance

PACKAGE OUTLINE DIMENSIONS in inches (millimeters)





Disclaimer

ALL PRODUCT, PRODUCT SPECIFICATIONS AND DATA ARE SUBJECT TO CHANGE WITHOUT NOTICE TO IMPROVE RELIABILITY, FUNCTION OR DESIGN OR OTHERWISE.

Vishay Intertechnology, Inc., its affiliates, agents, and employees, and all persons acting on its or their behalf (collectively, "Vishay"), disclaim any and all liability for any errors, inaccuracies or incompleteness contained in any datasheet or in any other disclosure relating to any product.

Vishay makes no warranty, representation or guarantee regarding the suitability of the products for any particular purpose or the continuing production of any product. To the maximum extent permitted by applicable law, Vishay disclaims (i) any and all liability arising out of the application or use of any product, (ii) any and all liability, including without limitation special, consequential or incidental damages, and (iii) any and all implied warranties, including warranties of fitness for particular purpose, non-infringement and merchantability.

Statements regarding the suitability of products for certain types of applications are based on Vishay's knowledge of typical requirements that are often placed on Vishay products in generic applications. Such statements are not binding statements about the suitability of products for a particular application. It is the customer's responsibility to validate that a particular product with the properties described in the product specification is suitable for use in a particular application. Parameters provided in datasheets and / or specifications may vary in different applications and performance may vary over time. All operating parameters, including typical parameters, must be validated for each customer application by the customer's technical experts. Product specifications do not expand or otherwise modify Vishay's terms and conditions of purchase, including but not limited to the warranty expressed therein.

Except as expressly indicated in writing, Vishay products are not designed for use in medical, life-saving, or life-sustaining applications or for any other application in which the failure of the Vishay product could result in personal injury or death. Customers using or selling Vishay products not expressly indicated for use in such applications do so at their own risk. Please contact authorized Vishay personnel to obtain written terms and conditions regarding products designed for such applications.

No license, express or implied, by estoppel or otherwise, to any intellectual property rights is granted by this document or by any conduct of Vishay. Product names and markings noted herein may be trademarks of their respective owners.

Looking for pricing, stock, or lifecycle information?

Click below to explore more details on WIN SOURCE:

 [View CS2J-E3/I on WIN SOURCE](#)

 [Vishay Information](#)

Optimize Your Supply Chain with WIN SOURCE Solutions

-  Global Sourcing Solution
-  Obsolete Management
-  Cost Control Management
-  Shortage Management
-  Alternative Solution
-  Excess Inventory Management