



THE DATASHEET OF
AP130-28YG-13



Features

- Input Voltage Range: 2.7V to 5.5V
- Dropout Voltage 400mV at 300mA Output Current
- Guaranteed 300mA Output Current
- Internal RON = 1.5Ω PMOS Draws No Base Current
- Low Quiescent Current 50μA
- Output Voltage: 1.5V/1.8V/2.0V/2.5V/2.8V/3.0V/3.3V/3.5; Accuracy 2%
- Fast Transient Response
- Good Load Regulation
- Current Limit and Thermal Shutdown Protection
- Short Circuit Current Fold-Back
- Lead Free Packages: SC59, SC59R, SOT89-3L, and SOT89R-3L
- SC59, SC59R, SOT23, SOT89-3L, and SOT89R-3L: Available in "Green" Molding Compound (No Br, Sb) (Note 9)
- Lead Free Finish/ RoHS Compliant (Note 1)

Description

The AP130 is a 300mA, fixed output voltage, low dropout linear regulator. The device includes pass element, error amplifier, band-gap, current-limit and thermal shutdown circuitry. The characteristics of low dropout voltage and less quiescent current make it good for some critical current application, for example, some battery powered devices. The typical quiescent current is approximately 50μA from zero to maximum load. Due to internal flexible design, results in extensively fixed output voltage versions and make it convenient to use for applications. Built-in current-limit and thermal-shutdown functions prevent any fault condition from IC damage.

Notes: 1. EU Directive 2002/95/EC (RoHS). All applicable RoHS exemptions applied. Please visit our website at http://www.diodes.com/products/lead_free.html.

Applications

- Battery Powered Device
- CD-ROM, DVD, and LAN Card
- PC Peripheral
- Wireless Communication

Typical Application Circuit

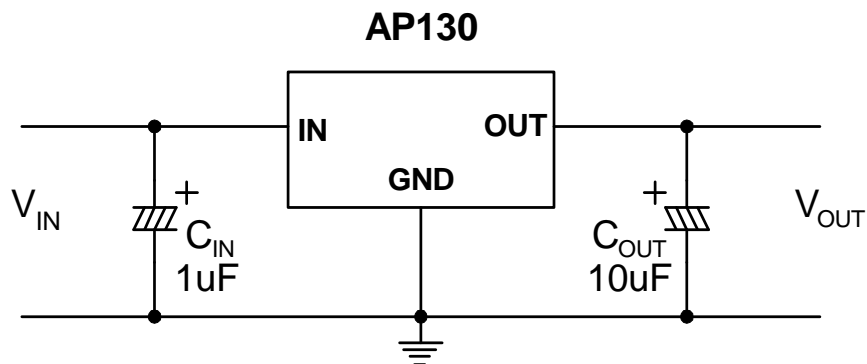

Pin Assignments

Package		No.	Pin Name	Description
Type	Code			
<p>(Top View)</p>  <p>(SC59)</p>	W	1	IN	IN: Power Input OUT: Output Voltage GND: Ground
		2	OUT	
		3	GND	
<p>(Top View)</p>  <p>(SC59R)</p>	R	1	GND	
		2	OUT	
		3	IN	
<p>(Top View)</p>  <p>(SOT23)</p>	SA	1	IN	
		2	OUT	
		3	GND	
<p>(Top View)</p>  <p>(SOT89-3L)</p>	Y	1	OUT	
		2	GND	
		3	IN	
<p>(Top View)</p>  <p>(SOT89R-3L)</p>	YR	1	GND	
		2	IN	
		3	OUT	

Functional Block Diagram



Absolute Maximum Ratings

Symbol	Parameter	Rating	Unit
V_{CC}	Input Voltage	+6	V
T_{OP}	Operating Junction Temperature	-40 to +125	°C
T_{ST}	Storage Temperature Range	-65 to +150	°C

Recommended Operating Conditions

Symbol	Parameter	Min	Max	Unit
V_{IN}	Input Voltage	2.7	5.5	V
I_{OUT}	Output Current	0	300	mA
T_A	Operating Ambient Temperature	-40	85	°C

Electrical Characteristics

$T_A = 25^\circ\text{C}$, $C_{IN} = 1\mu\text{F}$, $C_{OUT} = 10\mu\text{F}$, unless otherwise specified.

Symbol	Parameter	Conditions	Min	Typ.	Max	Unit
V_{DROD}	Dropout Voltage (Note 2)	$I_L = 300\text{mA}$	-	400	500	mV
I_{LIMIT}	Current Limit (Note 3)	$V_{IN} = 5\text{V}$, $V_{OUT} = 0\text{V}$	350	450	-	mA
I_{short}	Short Circuit Current	$V_{OUT} < 1.05\text{V}$	-	150	300	mA
ΔV_{LINE}	Line Regulation	$I_{OUT} = 1\text{mA}$, $V_{IN} = (V_{OUT} + 1\text{V})$ to 5.5V	-	0.1	0.3	%/V
PSRR	Ripple Rejection	$F = 100\text{Hz}$, $C_{IN} = 1\mu\text{F}$, $C_O = 10\mu\text{F}$, $I_L = 100\text{mA}$	-	58	-	dB
ΔV_{LOAD}	Load Regulation (Note 4)	$I_L = 1\sim 300\text{mA}$, $V_{IN} = 5\text{V}$	-	30	40	mV
ΔV_{OUT}	Output Voltage Accuracy	$I_L = 1\text{mA}$, $V_{IN} = 5\text{V}$	-2	-	+2	%
	Output Voltage Temperature Coefficient (Note 5)		-	50	150	PPM/ $^\circ\text{C}$
I_Q	Quiescent Current	$I_L = 0\text{mA}$, $V_{IN} = 5\text{V}$	-	50	100	μA
θ_{JA}	Thermal Resistance Junction-to-Ambient	SC59/SC59R (Note 6)	-	250	-	$^\circ\text{C}/\text{W}$
		SOT23 (Note 7)	-	200	-	
		SOT89-3L/SOT89R-3L (Note 8)	-	100	-	
θ_{JC}	Thermal Resistance Junction-to-Case	SC59/SC59R (Note 6)	-	79	-	$^\circ\text{C}/\text{W}$
		SOT23 (Note 7)	-	43	-	
		SOT89-3L/SOT89R-3L (Note 8)	-	23	-	

- Notes:
- Dropout voltage is defined as the input to output differential voltage. Dropout is measured at constant junction temperature by using pulsed on time, and the criterion is V_{OUT} inside target value $\pm 2\%$. This test is skipped at the condition of $V_{IN} < 3\text{V}$.
 - Current limit is measured at constant junction temperature by using pulsed testing with a low ON time.
 - Regulation is measured at constant junction temperature by using pulsed testing with a low ON time.
 - Guaranteed by design.
 - Test condition for SC59/SC59R: Devices mounted on FR-4 PC board, 1 MRP, 2oz copper, single sided, calibrate at $T_J = 125^\circ\text{C}$, $T_A = 25^\circ\text{C}$, with minimum recommended pad layout.
 - Test condition for SOT23: Devices mounted on FR-4 PC board, 1 MRP, calibrate at $T_J = 85^\circ\text{C}$, $T_A = 29^\circ\text{C}$.
 - Test condition for SOT89-3L/SOT89R-3L: No Heat Sink, no air flow.

Typical Performance Characteristics











Functional Descriptions

A minimum of 10 μF capacitor must be connected from OUT to ground to insure stability. Typically a large storage capacitor is connected from V_{IN} to ground to ensure that the input voltage does not sag below the minimum dropout voltage during the load transient response.

Ordering Information



	Device	Package Code	Packaging (Note 10)	7"/13" Tape and Reel	
				Quantity	Part Number Suffix
	AP130-XXWL-7	W	SC59	3000/Tape & Reel	-7
	AP130-XXWG-7	W	SC59	3000/Tape & Reel	-7
	AP130-XXRL-7	R	SC59R	3000/Tape & Reel	-7
	AP130-XXRG-7	R	SC59R	3000/Tape & Reel	-7
	AP130-XXSAG-7	SA	SOT23	3000/Tape & Reel	-7
	AP130-XXYL-13	Y	SOT89-3L	2500/Tape & Reel	-13
	AP130-XXYG-13	Y	SOT89-3L	2500/Tape & Reel	-13
	AP130-XXYRL-13	YR	SOT89R-3L	2500/Tape & Reel	-13
	AP130-XXYRG-13	YR	SOT89R-3L	2500/Tape & Reel	-13

Notes: 9. SOT23 is available in "Green" product only.
 10. Pad layout as shown on Diodes Inc. suggested pad layout document AP02001, which can be found on our website at <http://www.diodes.com/datasheets/ap02001.pdf>.

Marking Information

(1) SC59, SC59R and SOT23

(Top View)



XX : Identification code
Y : Year 0~9
W : Week : A~Z : 1~26 week;
a~z : 27~52 week; z represents
52 and 53 week
X : A~Z : Green
a~z : Lead Free

Device	Package (Note 11)	Identification Code
AP130-15W	SC59W	CA
AP130-18W	SC59W	CD
AP130-20W	SC59W	CF
AP130-25W	SC59W	CK
AP130-28W	SC59W	CN
AP130-30W	SC59W	CP
AP130-33W	SC59W	CS
AP130-35W	SC59W	CU
AP130-15R	SC59R	GO
AP130-18R	SC59R	GR
AP130-20R	SC59R	GT
AP130-25R	SC59R	GY
AP130-28R	SC59R	H1
AP130-30R	SC59R	H3
AP130-33R	SC59R	H9
AP130-35R	SC59R	HB
AP130-15SA	SOT23	U2
AP130-18SA	SOT23	U3
AP130-20SA	SOT23	U4
AP130-25SA	SOT23	U5
AP130-28SA	SOT23	U6
AP130-30SA	SOT23	U7
AP130-33SA	SOT23	U8
AP130-35SA	SOT23	U9

Marking Information (cont.)

(2) SOT89-3L and SOT89R-3L

(Top View)



XX : Identification code
Y : Year : 0~9
W : Week : A~Z : 1~26 week;
a~z : 27~52 week;
z represents 52 and 53 week
X : Internal code
A~Z : Green
a~z : Lead Free

Device	Package (Note 11)	Identification Code
AP130-15Y	SOT89-3L	CA
AP130-18Y	SOT89-3L	CD
AP130-20Y	SOT89-3L	CF
AP130-25Y	SOT89-3L	CK
AP130-28Y	SOT89-3L	CN
AP130-30Y	SOT89-3L	CP
AP130-33Y	SOT89-3L	CS
AP130-35Y	SOT89-3L	CU
AP130-15YR	SOT89R-3L	GO
AP130-18YR	SOT89R-3L	GR
AP130-20YR	SOT89R-3L	GT
AP130-25YR	SOT89R-3L	GY
AP130-28YR	SOT89R-3L	H1
AP130-30YR	SOT89R-3L	H3
AP130-33YR	SOT89R-3L	H9
AP130-35YR	SOT89R-3L	HB

Notes: 11. For Packaging Details, go to our website at <http://www.diodes.com/datasheets/ap02007.pdf>.

Package Outline Dimensions (All Dimensions in mm)

(1) Package Type: SC59 and SC59R



(2) Package Type: SOT23



Package Outline Dimensions (cont.)

(3) Package Type: SOT89-3L and SOT89R-3L



IMPORTANT NOTICE

DIODES INCORPORATED MAKES NO WARRANTY OF ANY KIND, EXPRESS OR IMPLIED, WITH REGARDS TO THIS DOCUMENT, INCLUDING, BUT NOT LIMITED TO, THE IMPLIED WARRANTIES OF MERCHANTABILITY AND FITNESS FOR A PARTICULAR PURPOSE (AND THEIR EQUIVALENTS UNDER THE LAWS OF ANY JURISDICTION).

Diodes Incorporated and its subsidiaries reserve the right to make modifications, enhancements, improvements, corrections or other changes without further notice to this document and any product described herein. Diodes Incorporated does not assume any liability arising out of the application or use of this document or any product described herein; neither does Diodes Incorporated convey any license under its patent or trademark rights, nor the rights of others. Any Customer or user of this document or products described herein in such applications shall assume all risks of such use and will agree to hold Diodes Incorporated and all the companies whose products are represented on Diodes Incorporated website, harmless against all damages.

Diodes Incorporated does not warrant or accept any liability whatsoever in respect of any products purchased through unauthorized sales channel.

Should Customers purchase or use Diodes Incorporated products for any unintended or unauthorized application, Customers shall indemnify and hold Diodes Incorporated and its representatives harmless against all claims, damages, expenses, and attorney fees arising out of, directly or indirectly, any claim of personal injury or death associated with such unintended or unauthorized application.

Products described herein may be covered by one or more United States, international or foreign patents pending. Product names and markings noted herein may also be covered by one or more United States, international or foreign trademarks.

LIFE SUPPORT

Diodes Incorporated products are specifically not authorized for use as critical components in life support devices or systems without the express written approval of the Chief Executive Officer of Diodes Incorporated. As used herein:

A. Life support devices or systems are devices or systems which:

1. are intended to implant into the body, or
2. support or sustain life and whose failure to perform when properly used in accordance with instructions for use provided in the labeling can be reasonably expected to result in significant injury to the user.

B. A critical component is any component in a life support device or system whose failure to perform can be reasonably expected to cause the failure of the life support device or to affect its safety or effectiveness.

Customers represent that they have all necessary expertise in the safety and regulatory ramifications of their life support devices or systems, and acknowledge and agree that they are solely responsible for all legal, regulatory and safety-related requirements concerning their products and any use of Diodes Incorporated products in such safety-critical, life support devices or systems, notwithstanding any devices- or systems-related information or support that may be provided by Diodes Incorporated. Further, Customers must fully indemnify Diodes Incorporated and its representatives against any damages arising out of the use of Diodes Incorporated products in such safety-critical, life support devices or systems.

Copyright © 2011, Diodes Incorporated

www.diodes.com

Looking for pricing, stock, or lifecycle information?

Click below to explore more details on WIN SOURCE:

 [View AP130-28YG-13 on WIN SOURCE](#)

 [Diodes Incorporated](#) Information

Optimize Your Supply Chain with WIN SOURCE Solutions

-  Global Sourcing Solution
-  Obsolete Management
-  Cost Control Management
-  Shortage Management
-  Alternative Solution
-  Excess Inventory Management