

General Description

The MIC5313 is a high performance, dual low input voltage, low dropout regulator. Major features include two 300mA LDOs, input voltage down to 1.7V, ultra low dropout of 85mV at full load. Each LDO has its own low voltage input for system flexibility. The low input voltages and low dropout operation provides high efficiency by reducing the input to output voltage step which minimizes the regulator power loss.

Ideal for battery operated applications; the MIC5313 offers 1% accuracy and low ground current to increase light load efficiency. The MIC5313 can also be put into a zero-off-mode current state, drawing virtually no current when disabled.

The MIC5313 is available in fixed output voltages in the 10-pin 2mm x 2mm Thin MLF[®] leadless package.

Data sheets and support documentation can be found on Micrel's web site at: www.micrel.com.

Features

- 300mA output current for each LDO
- Dual low voltage regulator inputs: 1.7V to 5.5V
- Low output voltage range: 0.8V to 2.0V
- Ultra-low dropout voltage of 85mV @ 300mA
- Stable with 1 μ F ceramic output capacitors
- Very fast transient response
- Thermal shutdown and current limit protection
- Tiny 10-pin 2mm x 2mm Thin MLF[®] package

Applications

- Mobile Phones
- GPS and Navigation Devices
- Portable Media Players
- Digital still and video cameras
- PDAs
- Portable electronics

Typical Application

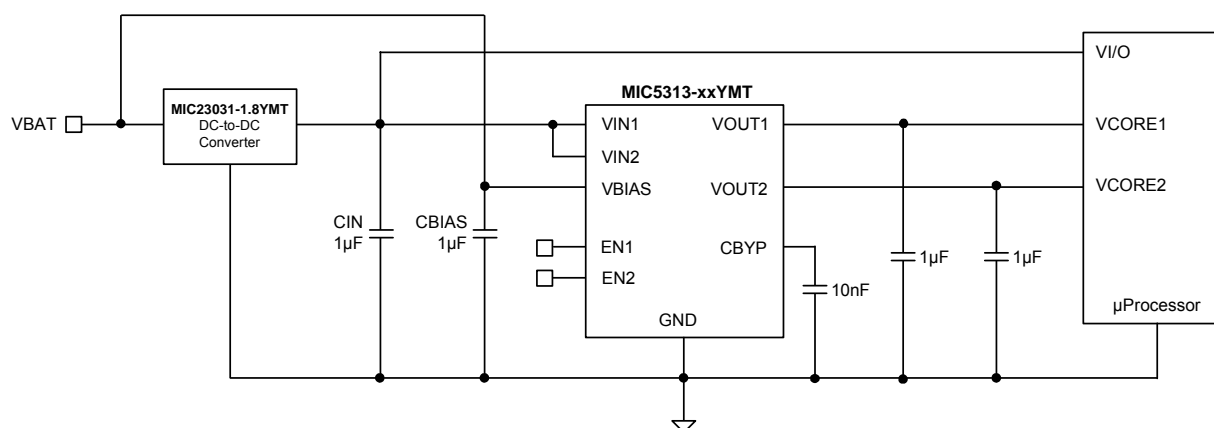

Ordering Information

Part Number	Manufacturing Part Number	Marking ⁽¹⁾	Voltage ⁽²⁾	Junction Temp. Range	Package ⁽³⁾
MIC5313-1.5/1.0YMT	MIC5313-FCYMT	FNC	1.5V/1.0V	-40°C to +125°C	10-Pin 2mm x 2mm Thin MLF [®]
MIC5313-1.5/1.1YMT	MIC5313-F3YMT	FN3	1.5V/1.1V	-40°C to +125°C	10-Pin 2mm x 2mm Thin MLF [®]
MIC5313-1.5/1.2YMT	MIC5313-F4YMT	FN4	1.5V/1.2V	-40°C to +125°C	10-Pin 2mm x 2mm Thin MLF [®]
MIC5313-1.5/1.3YMT	MIC5313-F5YMT	FN5	1.5V/1.3V	-40°C to +125°C	10-Pin 2mm x 2mm Thin MLF [®]
MIC5313-1.5/1.4YMT	MIC5313-F6YMT	FN6	1.5V/1.4V	-40°C to +125°C	10-Pin 2mm x 2mm Thin MLF [®]
MIC5313-1.5/1.5YMT	MIC5313-FFYMT	FNF	1.5V/1.5V	-40°C to +125°C	10-Pin 2mm x 2mm Thin MLF [®]
MIC5313-1.8/1.2YMT	MIC5313-G4YMT	GN4	1.8V/1.2V	-40°C to +125°C	10-Pin 2mm x 2mm Thin MLF [®]
MIC5313-1.8/1.8YMT	MIC5313-GGYMT	GNG	1.8V/1.8V	-40°C to +125°C	10-Pin 2mm x 2mm Thin MLF [®]

Notes:

- Pin 1 identifier = ▲.
- For other voltage option, contact Micrel Marketing for details
- MLF[®] is a GREEN RoHS compliant package. Lead finish is NiPdAu. Mold compound is Halogen Free.

Pin Configuration

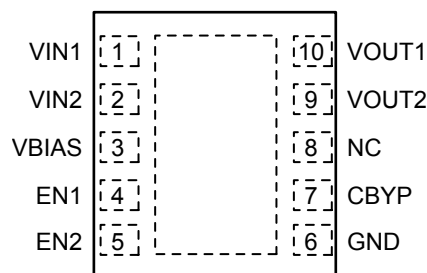

10-Pin 2mm x 2mm Thin MLF[®] (MT)

Pin Description

Pin Number	Pin Name	Pin Function
1	VIN1	Voltage Input for LDO1.
2	VIN2	Voltage Input for LDO2.
3	VBIAS	Bias Input Voltage.
4	EN1	Enable Input for LDO1. Active High Input. Logic High = On; Logic Low = Off; Do not leave floating.
5	EN2	Enable Input for LDO2. Active High Input. Logic High = On; Logic Low = Off; Do not leave floating.
6	GND	Ground.
7	CBYP	Bypass: Connect a capacitor to ground to improve output noise and PSRR.
8	NC	No Connect. Not internally Connected.
9	VOUT2	Output of regulator 2.
10	VOUT1	Output of regulator 1.

Absolute Maximum Ratings⁽¹⁾

Main Input Voltage (V_{IN1}, V_{IN2}).....	0V to V_{BIAS}
Bias Supply Voltage (V_{BIAS}).....	0V to +6V
Enable Input Voltage (V_{EN1}, V_{EN2})	0V to V_{BIAS}
Power Dissipation	Internally Limited ⁽³⁾
Lead Temperature (soldering, 3sec.).....	260°C
Storage Temperature (T_s)	-65°C to +150°C
ESD Rating ⁽⁴⁾	2kV

Operating Ratings⁽²⁾

Supply voltage (V_{IN1}, V_{IN2}).....	+1.7V to V_{BIAS}
Bias Supply Voltage (V_{BIAS})	2.5V to +5.5V
Enable Input Voltage (V_{EN1}, V_{EN2})	0V to V_{BIAS}
Junction Temperature (T_J)	-40°C to +125°C
Junction Thermal Resistance	
2mm x 2mm Thin MLF-10 (θ_{JA}).....	80°C/W

Electrical Characteristics⁽⁴⁾

$V_{BIAS} = 3.6V$; $V_{IN1} = V_{IN2} = V_{OUT}$ (Highest of two regulators) + 1V; $C_{BIAS} = C_{OUT} = 1.0\mu F$, $C_{BYP} = 0.01\mu F$, $I_{OUT} = 100\mu A$; $T_J = 25^\circ C$, **bold** values indicate -40°C to + 125°C; unless noted.

Parameter	Condition	Min	Typ	Max	Units
Output Voltage Accuracy	Variation from nominal V_{OUT1} & V_{OUT2}	-1.0		+1.0	%
	Variation from nominal V_{OUT1} & V_{OUT2}	-2.0		+2.0	%
V_{IN} Line Regulation	$V_{IN} = V_{OUT} + 1V$ to 5.5V, $V_{BIAS} = 5.5V$		0.02	0.3	%/V
V_{BIAS} Line Regulation	$V_{BIAS} = 3.6V$ to 5.5V, $V_{IN} = V_{OUT} + 1V$		0.02	0.3	%/V
Load Regulation	$I_{OUT} = 100\mu A$ to 300mA		0.4	1.0	%
Dropout Voltage	$I_{OUT} = 150mA$		40	100	mV
	$I_{OUT} = 300mA$		85	200	mV
Ground Pin Current V_{IN1}, V_{IN2}	$V_{EN1} = High$; $V_{EN2} = Low$; $I_{OUT1} = 100\mu A$ to 300mA		7	12	μA
	$V_{EN1} = Low$; $V_{EN2} = High$; $I_{OUT2} = 100\mu A$ to 300mA		7	12	μA
Ground Pin Current V_{BIAS}	$I_{OUT1} = I_{OUT2} = 100\mu A$ to 300mA		30	46	μA
Ground Pin Current in Shutdown	$V_{EN} \leq 0.2V$		0.01	1.0	μA
V_{IN} Ripple Rejection	$f = 1kHz$; $C_{OUT} = 1.0\mu F$; $C_{BYP} = 0.01\mu F$		65		dB
	$f = 20kHz$; $C_{OUT} = 1.0\mu F$; $C_{BYP} = 0.01\mu F$		40		dB
Current Limit	$V_{OUT} = 0V$	350	550		mA
Output Voltage Noise	$C_{OUT} = 1\mu F$, $C_{BYP} = 0.01\mu F$, 10Hz to 100kHz		30		μV_{RMS}
Enable					
Enable Input Voltage	Logic Low			0.2	V
	Logic High	1.2			V
Enable Input Current	$V_{IL} \leq 0.2V$		0.02	1	μA
	$V_{IH} \geq 1.2V$		0.2	1	μA
Turn-on Time	$C_{OUT} = 1\mu F$; $C_{BYP} = 0.01\mu F$		150	300	μs

Notes:

- Exceeding the absolute maximum rating may damage the device.
- The device is not guaranteed to function outside its operating rating.
- The maximum allowable power dissipation of any T_A (ambient temperature) is $P_{D(max)} = (T_{J(max)} - T_A) / \theta_{JA}$. Exceeding the maximum allowable power dissipation will result in excessive die temperature, and the regulator will go into thermal shutdown.
- Devices are ESD sensitive. Handling precautions recommended. Human body model, 1.5k Ω in series with 100pF.
- Specification for packaged product only.

Typical Characteristics

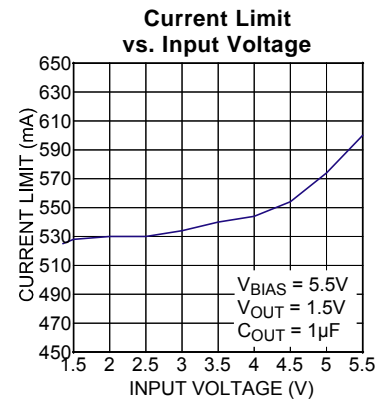
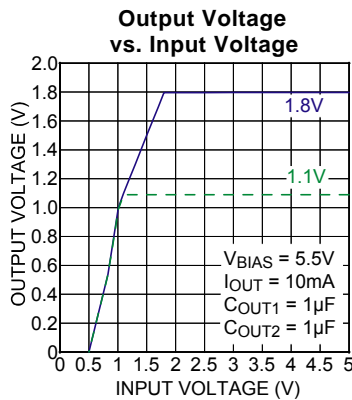
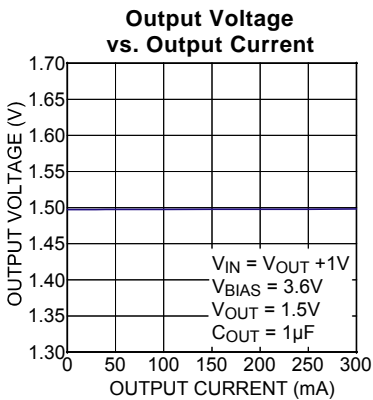
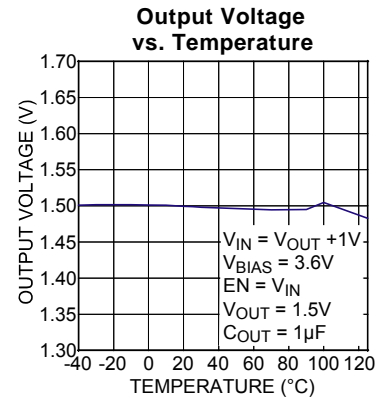
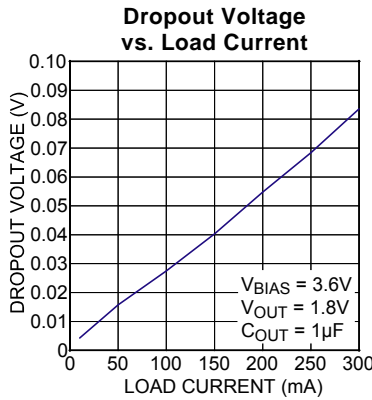
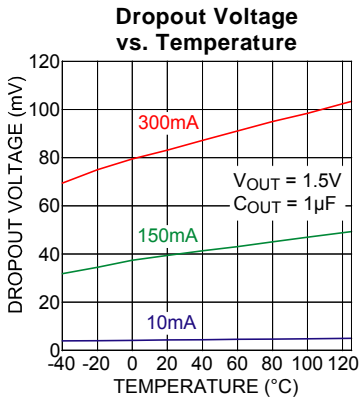
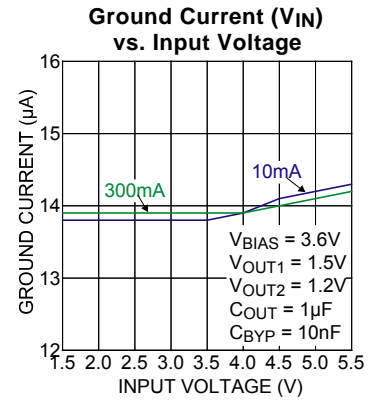
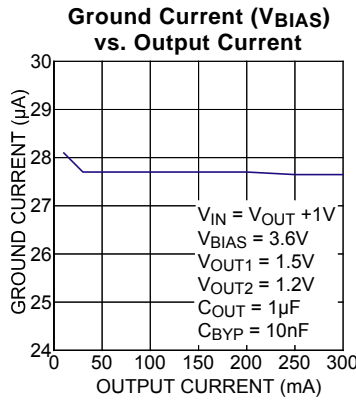
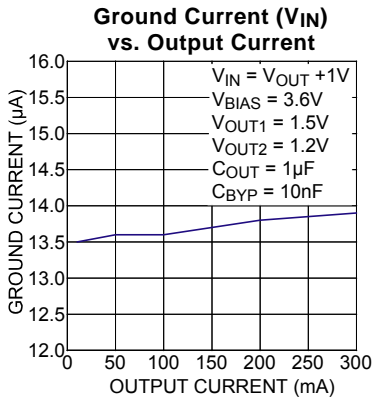
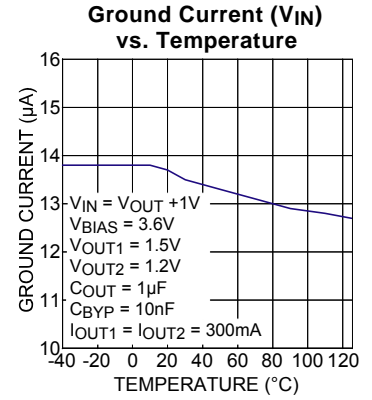
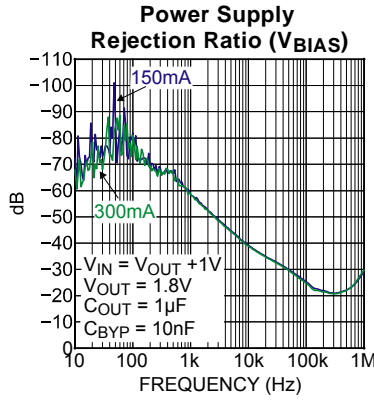
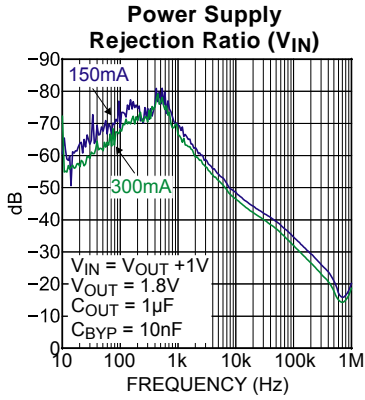

Typical Characteristics (continued)

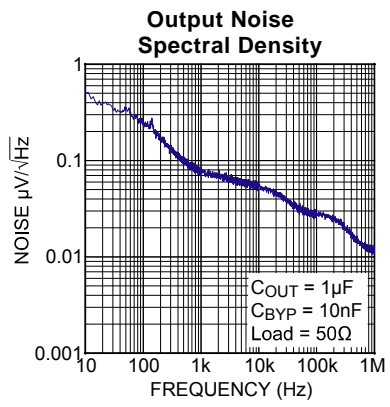

Functional Characteristics

Line Transient (V_{IN})

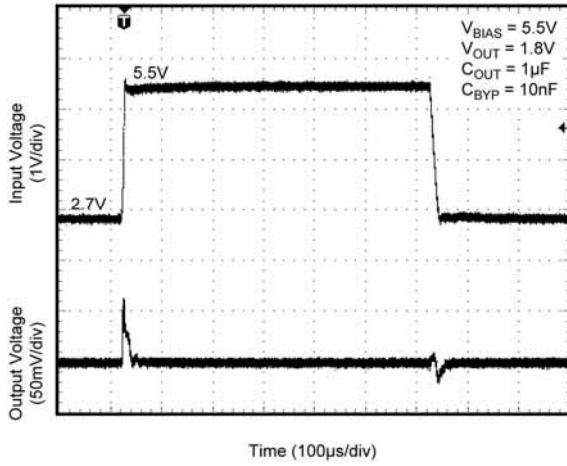

Line Transient (V_{BIAS})

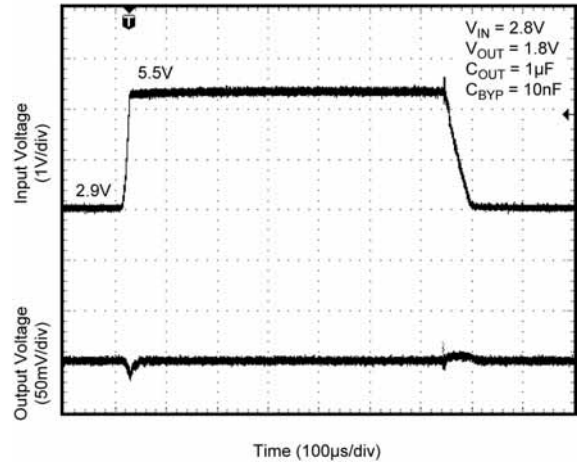

Load Transient

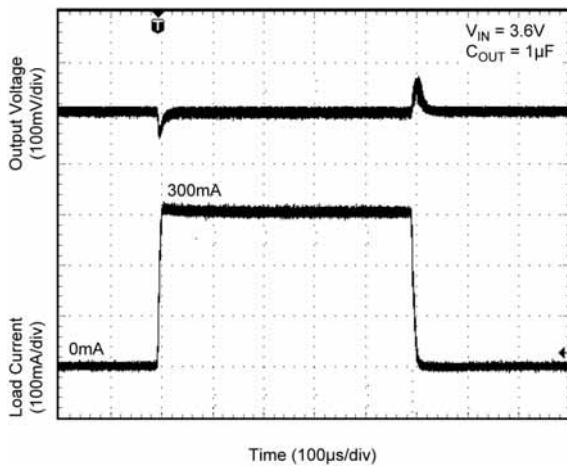

Load Transient

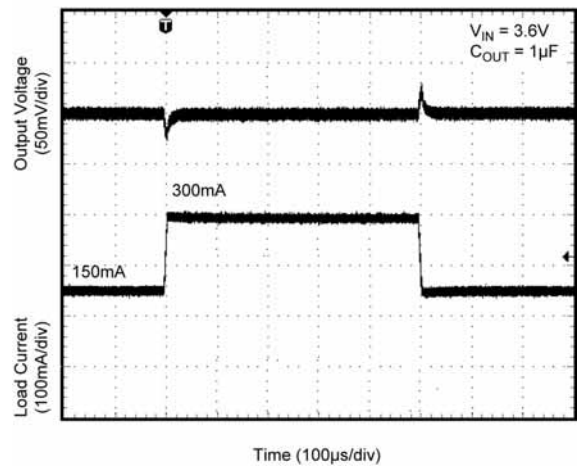

Enable Turn-On

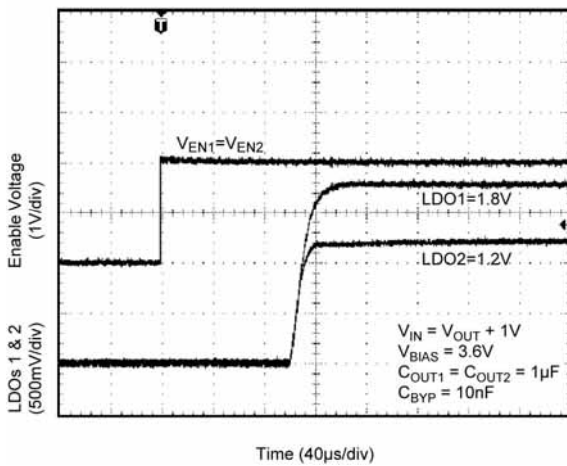

Functional Diagram

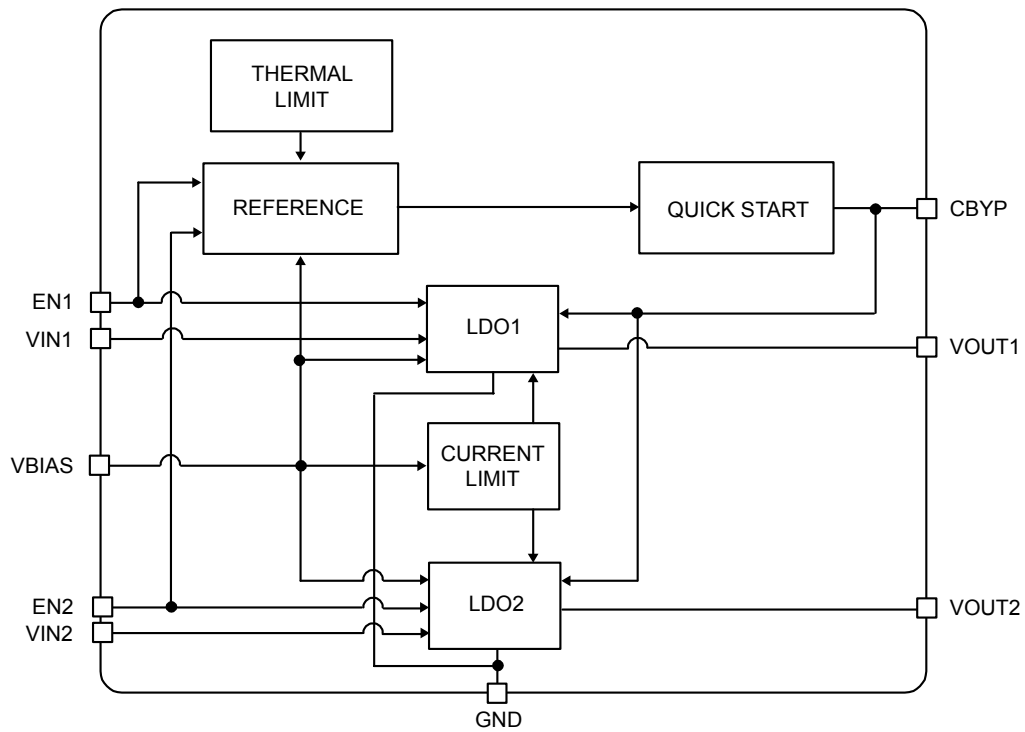

MIC5313 Block Diagram

Application Information

The MIC5313 is a high performance, dual low input voltage, ultra-low dropout regulator designed for applications requiring very fast transient response. The MIC5313 utilizes two input supplies (V_{IN} and V_{BIAS}), significantly reducing the dropout voltage.

The MIC5313 regulator is fully protected from damage due to fault conditions, offering linear current limiting and thermal shutdown.

Bias Supply Voltage

V_{BIAS} , requiring relatively light current, provides power to the control portion of the MIC5313. Bypassing on the bias pin is recommended to improve performance of the regulator during line and load transients. A $1\mu\text{F}$ ceramic capacitor from V_{BIAS} -to-ground is recommended to help reduce the high frequency noise from being injected into the control circuitry.

Input Supply Voltage

V_{IN1} and V_{IN2} , provide the supply to power the LDOs independently. The minimum input voltage is 1.7V allowing conversion from low voltage supplies. The low input voltage provides high efficiency by reducing the input to output voltage step which minimizes the regulator power loss.

Input Capacitor

The MIC5313 is a high-performance, high bandwidth device. Therefore, it requires a well-bypassed input supply for optimal performance. A $1\mu\text{F}$ capacitor is required from the input-to-ground to provide stability. Low-ESR ceramic capacitors provide optimal performance at a minimum of space. Additional high-frequency capacitors, such as small-valued NPO dielectric-type capacitors, help filter out high-frequency noise and are good practice in any RF-based circuit. X5R or X7R dielectrics are recommended for the input capacitor. Y5V dielectrics lose most of their capacitance over temperature and are therefore, not recommended.

Output Capacitor

The MIC5313 requires an output capacitor of $1\mu\text{F}$ or greater to maintain stability. The design is optimized for use with low-ESR ceramic chip capacitors. High ESR capacitors may cause high frequency oscillation. The output capacitor can be increased, but performance has been optimized for a $1\mu\text{F}$ ceramic output capacitor and does not improve significantly with larger capacitance.

X7R/X5R dielectric-type ceramic capacitors are recommended because of their temperature performance. X7R-type capacitors change capacitance by 15% over their operating temperature range and are the most stable type of ceramic capacitors. Z5U and

Y5V dielectric capacitors change value by as much as 50% and 60%, respectively, over their operating temperature ranges. To use a ceramic chip capacitor with Y5V dielectric, the value must be much higher than an X7R ceramic capacitor to ensure the same minimum capacitance over the equivalent operating temperature range.

Bypass Capacitor

A capacitor can be placed from the bypass pin-to-ground to reduce the output voltage noise. The capacitor bypasses the internal reference. A $0.01\mu\text{F}$ capacitor is recommended for applications that require low-noise outputs. The bypass capacitor can be increased, further reducing noise and improving PSRR. Turn-on time increases slightly with respect to the bypass capacitance. A unique, quick-start circuit allows the MIC5313 to drive a large capacitor on the bypass pin without significantly slowing turn-on time.

No-Load Stability

Unlike many other voltage regulators, the MIC5313 will remain stable and in regulation with no load. This is especially important in CMOS RAM keep-alive applications.

Enable/Shutdown

The MIC5313 is provided with dual active-high enable pins that allow each regulator to be disabled independently. Forcing the enable pin low disables the regulator and sends it into a “zero” off-mode-current state. In this state, current consumed by the regulator goes nearly to zero. Forcing the enable pin high enables the output voltage. The active-high enable pin uses CMOS technology and the enable pin cannot be left floating; a floating enable pin may cause an indeterminate state on the output.

Thermal Considerations

The MIC5313 is designed to provide 300mA of continuous current for both outputs in a very small package. Maximum ambient operating temperature can be calculated based upon the output current and the voltage drop across the part. Given that the input voltage is 1.8V, the output voltage is 1.5V for V_{OUT1} , 1.0V for V_{OUT2} and the output current = 300mA for each output. The actual power dissipation of the regulator circuit can be determined using the equation:

$$P_D = (V_{IN} - V_{OUT1}) I_{OUT1} + (V_{IN} - V_{OUT2}) I_{OUT2} + V_{BIAS} I_{GND}$$

Because this device is CMOS and the ground current is typically $<100\mu\text{A}$ over the load range, the power dissipation contributed by the ground current is $<1\%$ and can be ignored for this calculation.

$$P_D = (1.8V - 1.5V) \times 300\text{mA} + (1.8V - 1.0V) \times 300\text{mA}$$

$$P_D = 0.33\text{W}$$

To determine the maximum ambient operating temperature of the package, use the junction-to-ambient thermal resistance of the device and the following basic equation:

$$P_{D(MAX)} = \left(\frac{T_{J(MAX)} - T_A}{\theta_{JA}} \right)$$

$T_{J(max)} = 125^{\circ}\text{C}$, the maximum junction temperature of the die. The junction-to-ambient thermal resistance for the minimum footprint, is $\theta_{JA} = 80^{\circ}\text{C/W}$.

Substituting P_D for $P_{D(max)}$ and solving for the ambient operating temperature will give the maximum operating conditions for the regulator circuit.

The maximum power dissipation must not be exceeded for proper operation.

For example, when operating the MIC5313-FCYMT at an input voltage of 1.8V and 300mA, loads at each output with a minimum footprint layout, the maximum ambient operating temperature T_A can be determined as follows:

$$0.33\text{W} = (125^{\circ}\text{C} - T_A)/(80^{\circ}\text{C/W})$$

$$T_A = 98.6^{\circ}\text{C}$$

For a full discussion of heat sinking and thermal effects on voltage regulators, refer to the "Regulator Thermals" section of *Micrel's Designing with Low-Dropout Voltage Regulators* handbook. This information can be found on Micrel's website at:

http://www.micrel.com/_PDF/other/LDOBk_ds.pdf

MIC5313 Typical Application Circuit

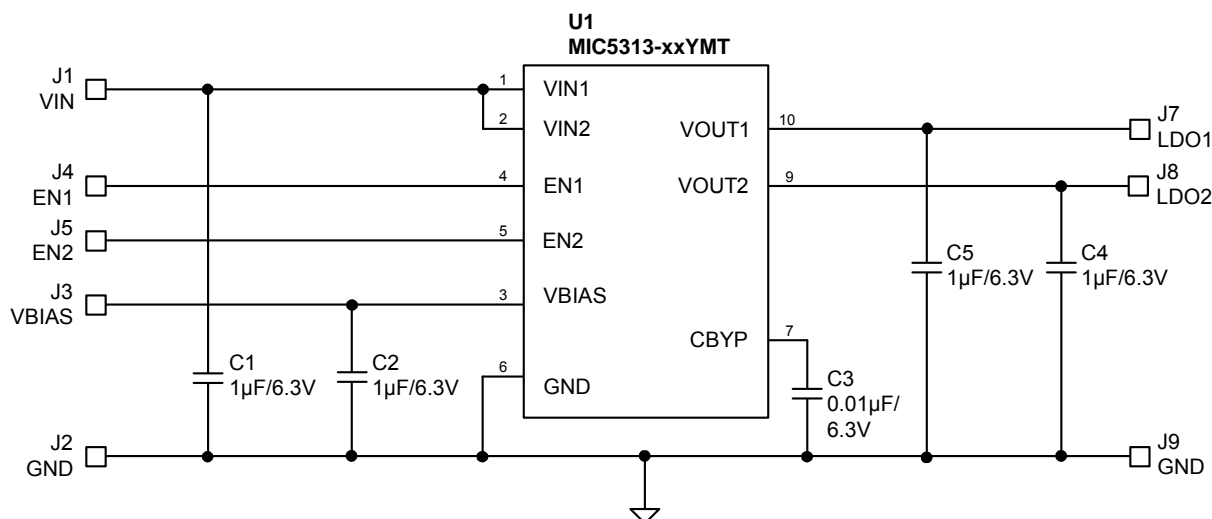

Bill of Materials

Item	Part Number	Manufacturer	Description	Qty
C1, C2, C4, C5	C1608X5R1A105K	TDK ⁽¹⁾	Capacitor, 1µF Ceramic, 10V, X5R, Size 0603	4
C3	VJ0603Y103KXAAT	Vishay ⁽²⁾	Capacitor, 0.01µF, 50V, X7R, Size 0603	1
C6	C1608X5R0J106M	TDK ⁽¹⁾	Open	1
U1	MIC5313-xxYMT	Micrel ⁽³⁾	Low Voltage Dual 300mA LDO	1

Notes:

1. TDK: www.tdk.com
2. Vishay: www.vishay.com
3. Micrel, Inc.: www.micrel.com

PCB Layout Recommendations

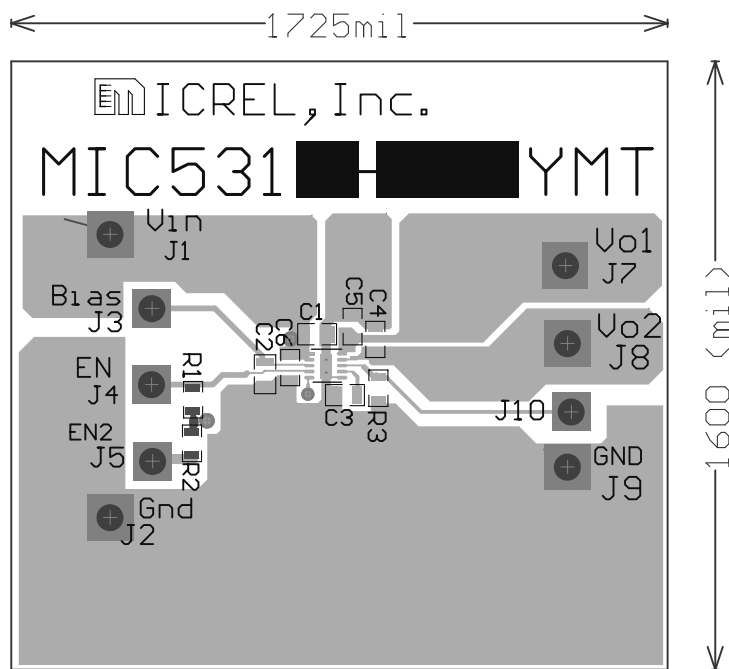

Top Layer

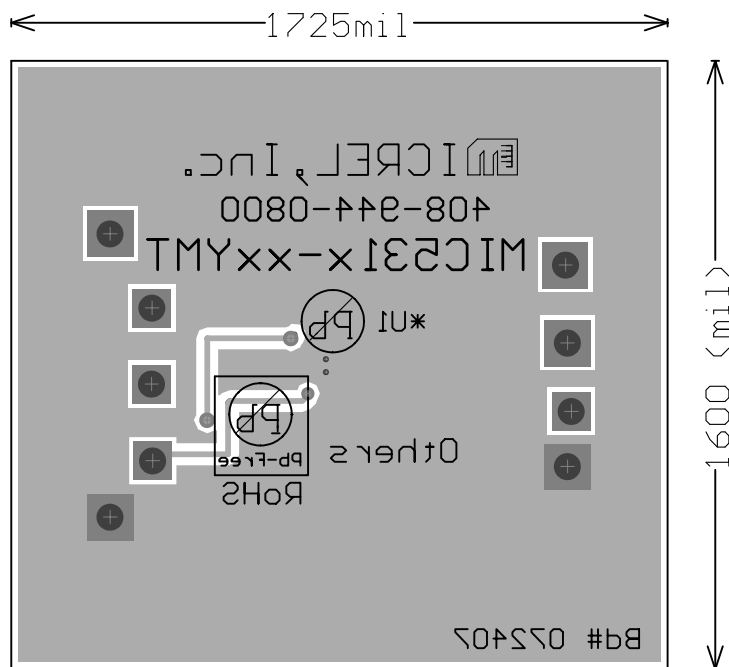

Bottom Layer

Package Information

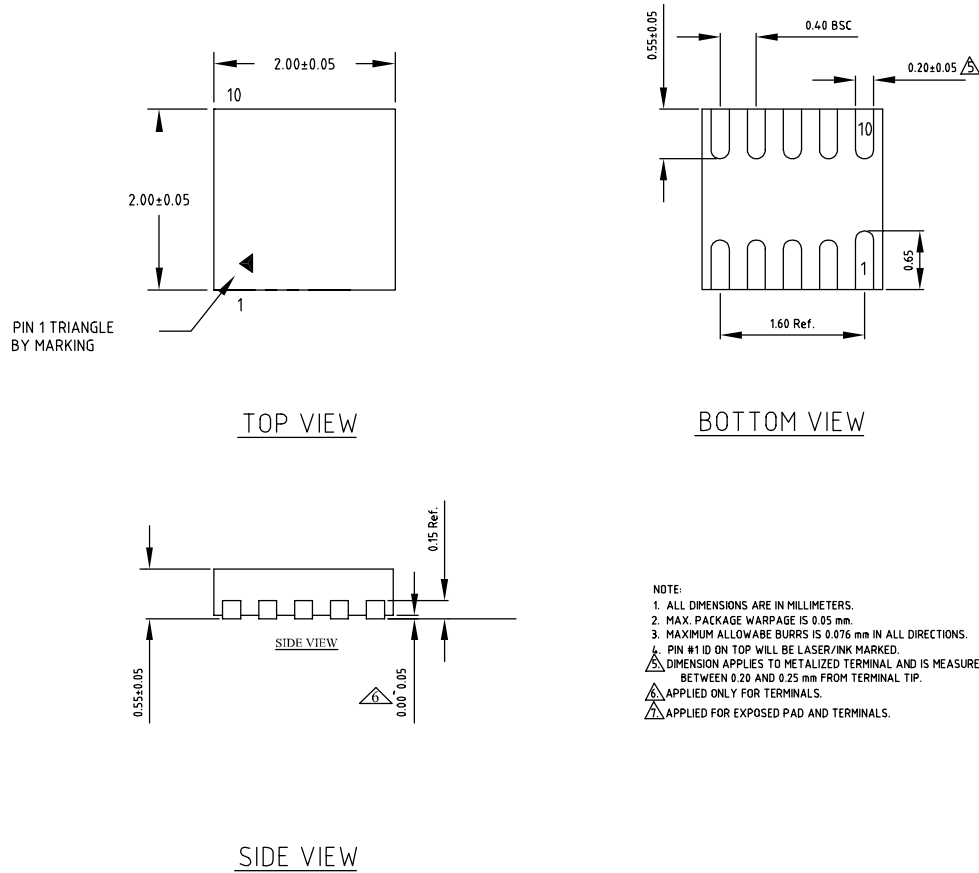

10-Pin 2mm x 2mm Thin MLF[®] (MT)

MICREL, INC. 2180 FORTUNE DRIVE SAN JOSE, CA 95131 USA
 TEL +1 (408) 944-0800 FAX +1 (408) 474-1000 WEB <http://www.micrel.com>

The information furnished by Micrel in this data sheet is believed to be accurate and reliable. However, no responsibility is assumed by Micrel for its use. Micrel reserves the right to change circuitry and specifications at any time without notification to the customer.

Micrel Products are not designed or authorized for use as components in life support appliances, devices or systems where malfunction of a product can reasonably be expected to result in personal injury. Life support devices or systems are devices or systems that (a) are intended for surgical implant into the body or (b) support or sustain life, and whose failure to perform can be reasonably expected to result in a significant injury to the user. A Purchaser's use or sale of Micrel Products for use in life support appliances, devices or systems is a Purchaser's own risk and Purchaser agrees to fully indemnify Micrel for any damages resulting from such use or sale.

© 2008 Micrel, Incorporated.

Looking for pricing, stock, or lifecycle information?

Click below to explore more details on WIN SOURCE:

- [View MIC5313-G4YMT-TR on WIN SOURCE](#)
- [Microchip Technology Information](#)

Optimize Your Supply Chain with WIN SOURCE Solutions

- ✓ Global Sourcing Solution
- ✓ Obsolete Management
- ✓ Cost Control Management
- ✓ Shortage Management
- ✓ Alternative Solution
- ✓ Excess Inventory Management