



THE DATASHEET OF TDA7851A



4 x 48 W MOSFET quad bridge power amplifier

Datasheet – production data

Features

- Multipower BCD technology
- High output power capability:
 - 4 x 48 W/4 Ω Max.
 - 4 x 28 W/4 Ω @ 14.4 V, 1 kHz, 10 %
 - 4 x 72 W/2 Ω Max.
- MOSFET output power stage
- Excellent 2 Ω driving capability
- Hi-Fi class distortion
- Low output noise
- Standby function
- Mute function
- Automute at min. supply voltage detection
- Low external component count:
 - Internally fixed gain (26 dB)
 - No external compensation
 - No bootstrap capacitors
- Protections:
 - Output short circuit to GND, to Vs, across the load
 - Very inductive loads
 - Overrating chip temperature with soft thermal limiter
 - Output DC offset detection
 - Load dump voltage

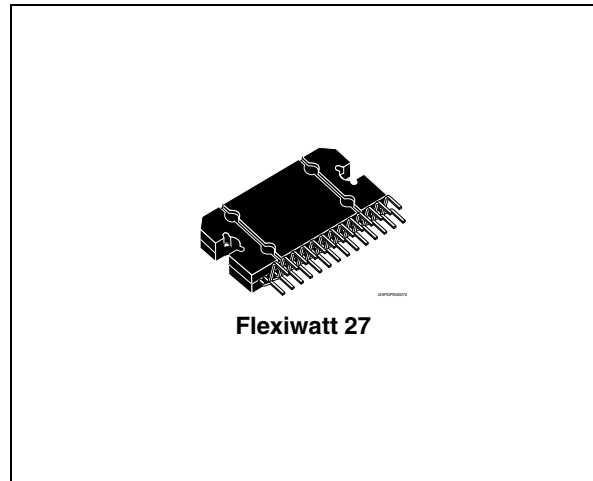

Flexiwatt 27

- Fortuitous open GND
- Reversed battery
- ESD

Description

The TDA7851A is a breakthrough MOSFET technology class AB audio power amplifier, designed for high-power car radio.

The fully complementary P-Channel/N-Channel output structure allows a rail-to-rail output voltage swing. This, combined with high output current and minimized saturation losses, sets new power references in the car-radio field, with unparalleled distortion performance.

Table 1. Device summary

| Order code | Package | Packing |
|------------|--------------|---------|
| TDA7851A | Flexiwatt 27 | Tube |

Contents

- 1 Block diagram and application circuit 5**
 - 1.1 Block diagram 5
 - 1.2 Application circuit 5

- 2 Pin description 6**
 - 2.1 Pin connection 6
 - 2.2 Thermal data 6

- 3 Electrical specifications 7**
 - 3.1 Absolute maximum ratings 7
 - 3.2 Electrical characteristics 7
 - 3.3 Electrical characteristics curves 9

- 4 Application hints 12**
 - 4.1 DC offset detector 12
 - 4.2 SVR 12
 - 4.3 Input stage 12
 - 4.4 Standby and muting 12
 - 4.5 Heatsink definition 12

- 5 Package information 13**

- 6 Revision history 14**

List of tables

| | | |
|----------|--------------------------------------|----|
| Table 1. | Device summary | 1 |
| Table 2. | Thermal data | 6 |
| Table 3. | Absolute maximum ratings | 7 |
| Table 4. | Electrical characteristics | 7 |
| Table 5. | Document revision history | 14 |

List of figures

| | | |
|------------|---|----|
| Figure 1. | Block diagram | 5 |
| Figure 2. | Application circuit | 5 |
| Figure 3. | Pin connection (top view) | 6 |
| Figure 4. | Quiescent current vs. supply voltage | 9 |
| Figure 5. | Output power vs. supply voltage ($R_L = 4 \Omega$) | 9 |
| Figure 6. | Output power vs. supply voltage ($R_L = 2 \Omega$) | 9 |
| Figure 7. | Distortion vs. output power ($R_L = 4 \Omega$) | 9 |
| Figure 8. | Distortion vs. output power ($R_L = 2 \Omega$) | 9 |
| Figure 9. | Distortion vs. frequency ($R_L = 4 \Omega$) | 9 |
| Figure 10. | Distortion vs. frequency ($R_L = 2 \Omega$) | 10 |
| Figure 11. | Crosstalk vs. frequency | 10 |
| Figure 12. | Supply voltage rejection vs. frequency | 10 |
| Figure 13. | Output attenuation vs. supply voltage | 10 |
| Figure 14. | Power dissipation and efficiency vs. output power ($R_L = 4 \Omega$, SINE) | 10 |
| Figure 15. | Power dissipation and efficiency vs. output power ($R_L = 2 \Omega$, SINE) | 10 |
| Figure 16. | Power dissipation vs. output power ($R_L = 4 \Omega$, audio program simulation) | 11 |
| Figure 17. | Power dissipation vs. output power ($R_L = 2 \Omega$, audio program simulation) | 11 |
| Figure 18. | ITU R-ARM frequency response, weighting filter for transient pop. | 11 |
| Figure 19. | Flexiwatt27 mechanical data and package dimensions | 13 |

1 Block diagram and application circuit

1.1 Block diagram

Figure 1. Block diagram

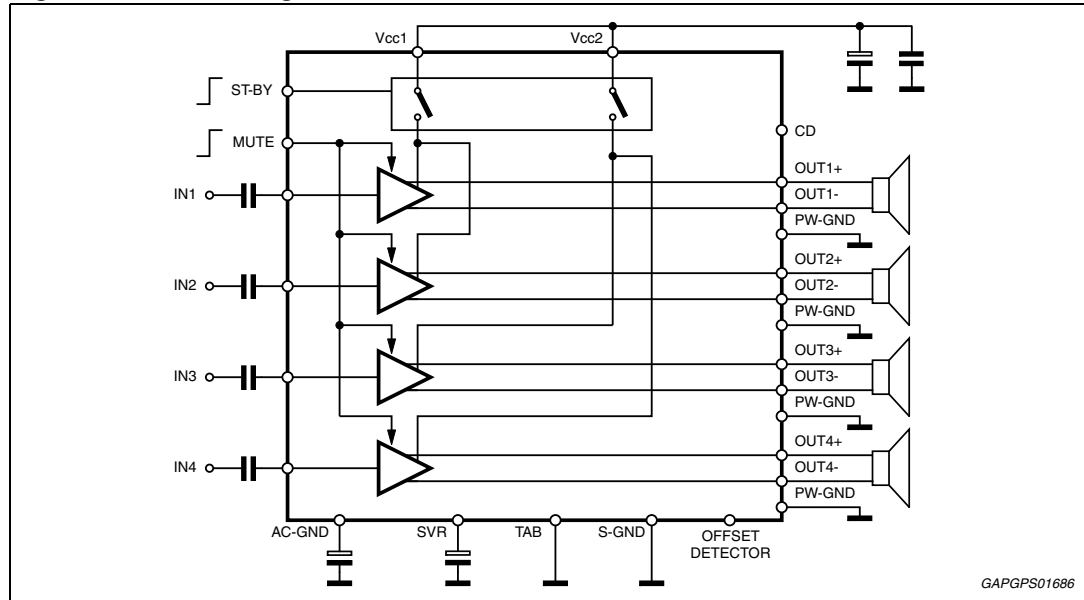

GAPGPS01686

1.2 Application circuit

Figure 2. Application circuit

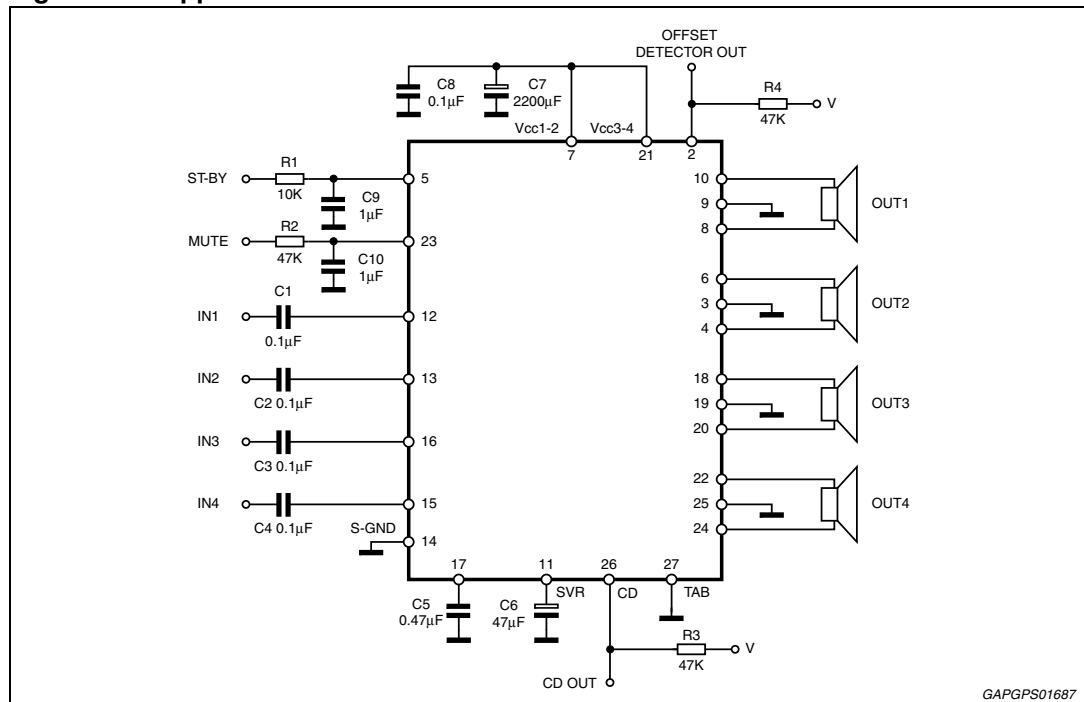

GAPGPS01687

2 Pin description

2.1 Pin connection

Figure 3. Pin connection (top view)

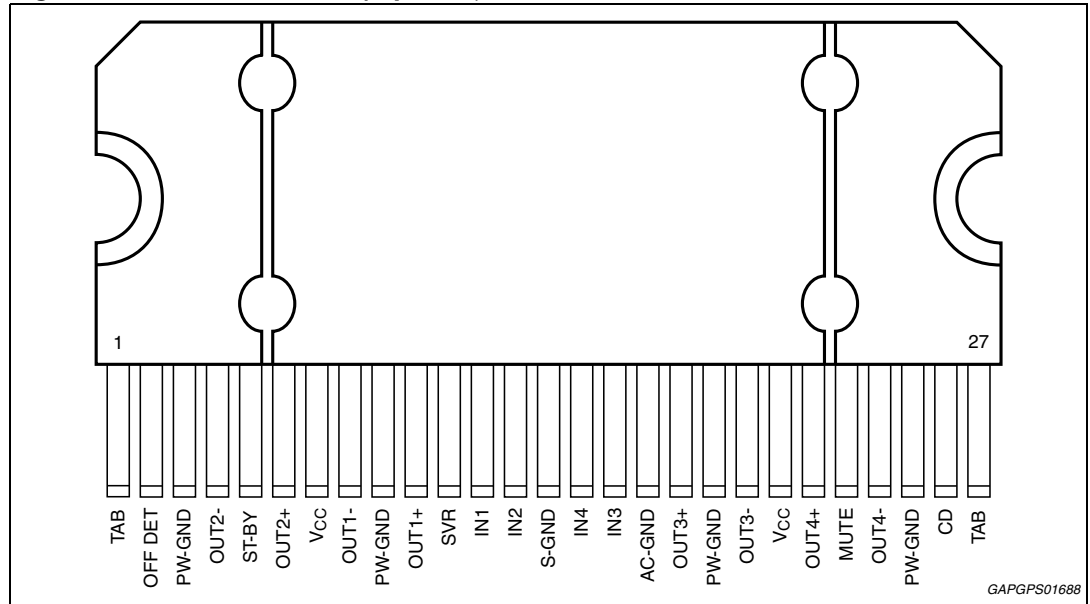

2.2 Thermal data

Table 2. Thermal data

| Symbol | Parameter | Value | Unit |
|------------------|-------------------------------------|-------|------|
| $R_{th\ j-case}$ | Thermal resistance junction-to-case | Max 1 | °C/W |

3 Electrical specifications

3.1 Absolute maximum ratings

Table 3. Absolute maximum ratings

| Symbol | Parameter | Value | Unit |
|-------------|--|------------|------|
| V_S | Operating supply voltage | 18 | V |
| $V_{S(DC)}$ | DC supply voltage | 28 | V |
| $V_{S(pk)}$ | Peak supply voltage (for $t = 50$ ms) | 50 | V |
| I_O | Output peak current Non repetitive ($t = 100$ μ s) | 10 | A |
| | Repetitive (duty cycle 10 % at $f = 10$ Hz) | 9 | A |
| P_{tot} | Power dissipation $T_{case} = 70$ °C | 85 | W |
| T_j | Junction temperature | 150 | °C |
| T_{stg} | Storage temperature | -55 to 150 | °C |

3.2 Electrical characteristics

Refer to the test and application diagram, $V_S = 14.4$ V; $R_L = 4$ Ω ; $R_g = 600$ Ω ; $f = 1$ kHz;
 $T_{amb} = 25$ °C; unless otherwise specified.

Table 4. Electrical characteristics

| Symbol | Parameter | Test condition | Min. | Typ. | Max. | Unit |
|--------------|---|---|------|------|---------|------|
| V_S | Supply voltage range | - | 8 | - | 18 | V |
| I_{q1} | Quiescent current | $R_L = \infty$ | 100 | 150 | 300 | mA |
| V_{OS} | Output offset voltage | Play mode / Mute mode | -60 | - | +60 | mV |
| dV_{OS} | During mute ON/OFF output offset voltage | ITU R-ARM weighted see Figure 18 | -10 | - | +10 | mV |
| | During standby ON/OFF output offset voltage | | -10 | - | +10 | mV |
| G_v | Voltage gain | - | 25 | 26 | 27 | dB |
| dG_v | Channel gain unbalance | - | - | - | ± 1 | dB |
| P_o | Output power | $V_S = 14.4$ V; THD = 10 % | 25 | 28 | - | W |
| | | $V_S = 14.4$ V; THD = 1 % | - | 22 | - | W |
| | | $V_S = 14.4$ V; THD = 10 %, 2 Ω | - | 48 | - | W |
| | | $V_S = 14.4$ V; THD = 1 %, 2 Ω | - | 38 | - | W |
| $P_{o max.}$ | Max. output power ⁽¹⁾ | $V_S = 14.4$ V; $R_L = 4$ Ω | - | 45 | - | W |
| | | $V_S = 14.4$ V; $R_L = 2$ Ω | - | 75 | - | W |
| | | $V_S = 15.2$ V; $R_L = 4$ Ω | - | 48 | - | W |
| THD | Distortion | $P_o = 4$ W | - | 0.01 | 0.05 | % |

Table 4. Electrical characteristics (continued)

| Symbol | Parameter | Test condition | Min. | Typ. | Max. | Unit |
|--------------------------|-------------------------------------|---|------|------|------|------|
| e _{No} | Output noise | "A" Weighted | - | 35 | 100 | μV |
| | | Bw = 20 Hz to 20 kHz | | 50 | | μV |
| SVR | Supply voltage rejection | f = 100 Hz; V _r = 1 Vrms | 50 | 70 | - | dB |
| f _{ch} | High cut-off frequency | P _O = 0.5 W | 100 | 300 | - | kHz |
| R _i | Input impedance | - | 70 | 100 | 130 | kΩ |
| C _T | Cross talk | f = 1 kHz, P _O = 4 W | 60 | 70 | - | dB |
| | | f = 10 kHz, P _O = 4 W | - | 60 | - | dB |
| I _{SB} | Standby current consumption | V _{St-by} = 1.2 V | - | - | 20 | μA |
| | | V _{St-by} = 0 | - | - | 10 | μA |
| I _{pin5} | Standby pin current | V _{St-by} = 1.2 V to 2.6 V | - | - | ±1 | μA |
| V _{SB out} | Standby out threshold voltage | (Amp: ON) | 2.6 | - | - | V |
| V _{SB in} | Standby in threshold voltage | (Amp: OFF) | - | - | 1.2 | V |
| A _M | Mute attenuation | P _{Oref} = 4 W | 80 | 90 | - | dB |
| V _{M out} | Mute out threshold voltage | (Amp: Play) | 2.6 | - | - | V |
| V _{M in} | Mute in threshold voltage | (Amp: Mute) | - | - | 1.2 | V |
| V _{AM in} | V _S automute threshold | (Amp: Mute) Att ≥ 80 dB; P _{Oref} = 4 W | 6.7 | 7 | - | V |
| | | (Amp: Play) Att < 0.1 dB; P _O = 0.5 W | - | 7.5 | 8 | V |
| I _{pin23} | Muting pin current | V _{MUTE} = 1.2 V (Sourced current) | 7 | 12 | 18 | μA |
| | | V _{MUTE} = 2.6 V | -5 | - | 18 | μA |
| Offset detector | | | | | | |
| V _{OFF} | Detected differential output offset | V _{St-by} = 5 V | ±1 | ±2 | ±3 | V |
| V _{OFF_SAT} | Off detector saturation voltage | V _O > ±3 V, I _{off Det} = 1 mA 0 V < V _{off Det} < 18 V | - | 0.2 | 0.4 | V |
| V _{OFF_LK} | Off detector leakage current | V _O < ±1 V | - | 0 | 15 | μA |
| Clipping detector | | | | | | |
| CD _{LK} | Clip detector high leakage current | Cd off | - | 0 | 1 | μA |
| CD _{SAT} | Clip detector saturation voltage | DC On; I _{CD} = 1 mA | - | 0.2 | 0.4 | V |
| CD _{THD} | Clip detector THD level | - | - | 2 | - | % |

1. Saturated square wave output

3.3 Electrical characteristics curves

Figure 4. Quiescent current vs. supply voltage

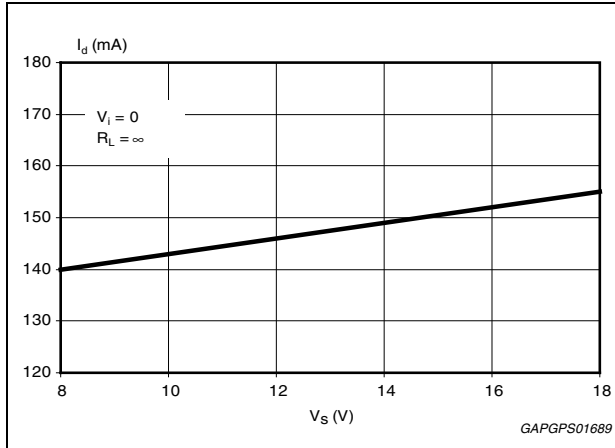

Figure 5. Output power vs. supply voltage (RL = 4 Ω)

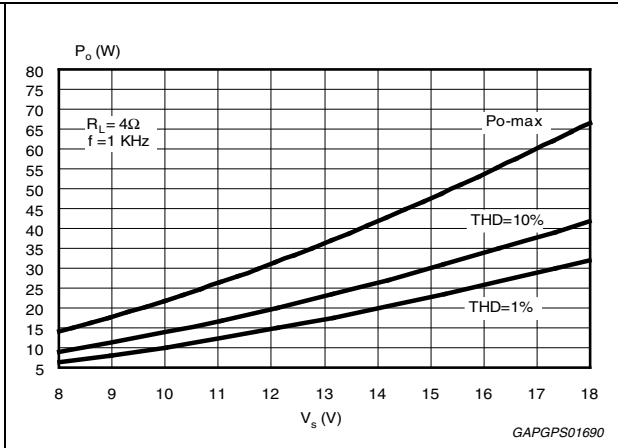

Figure 6. Output power vs. supply voltage (RL = 2 Ω)

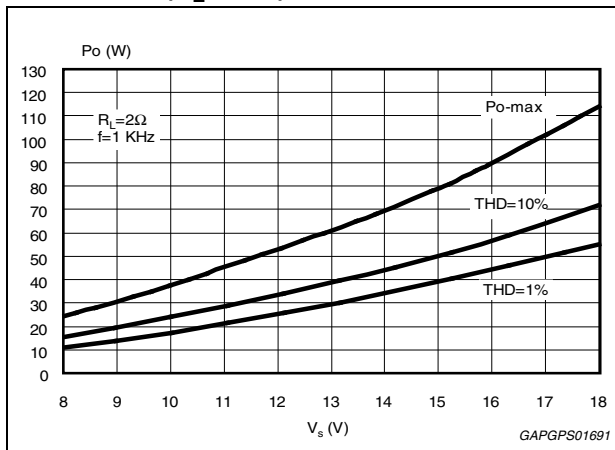

Figure 7. Distortion vs. output power (RL = 4 Ω)

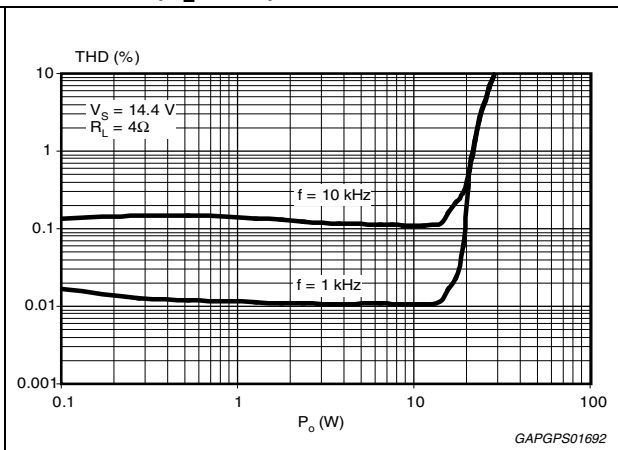

Figure 8. Distortion vs. output power (RL = 2 Ω)

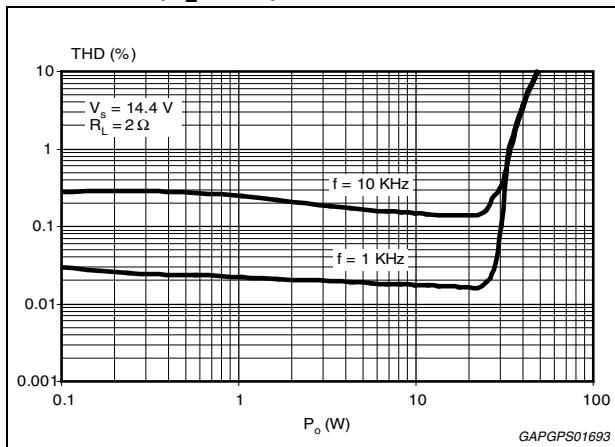

Figure 9. Distortion vs. frequency (RL = 4 Ω)

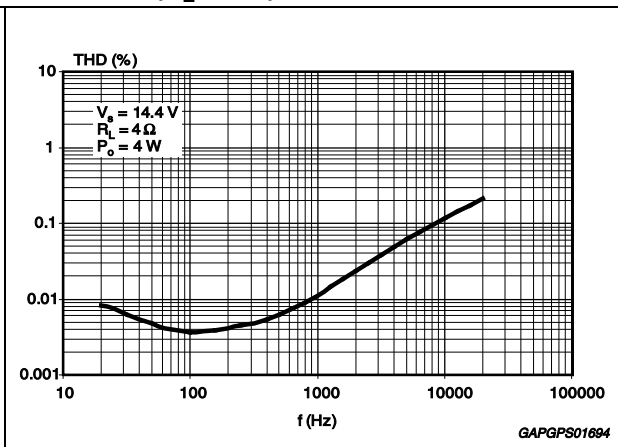

Figure 10. Distortion vs. frequency ($R_L = 2 \Omega$)

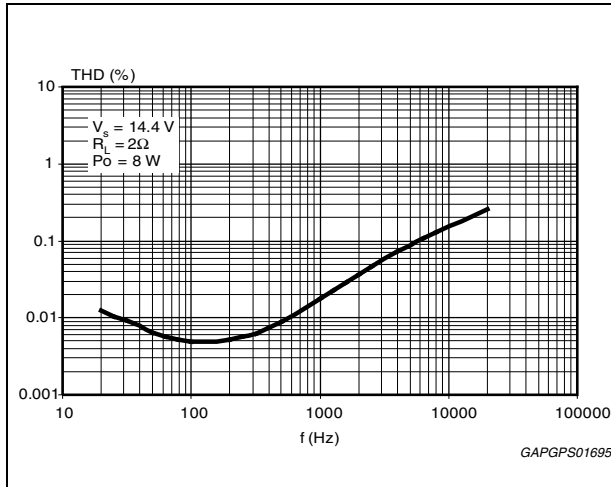

Figure 11. Crosstalk vs. frequency

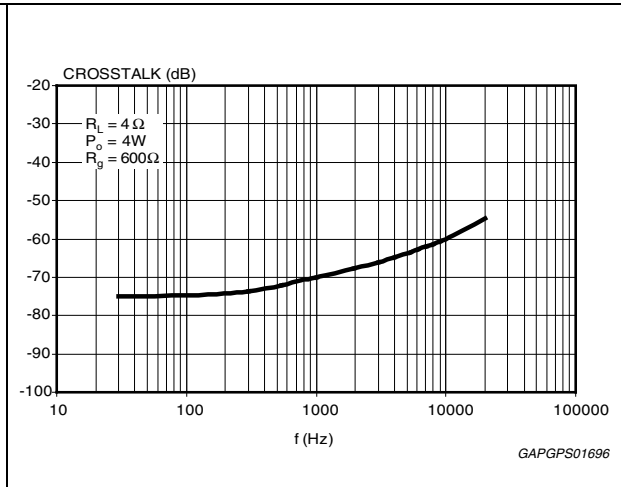

Figure 12. Supply voltage rejection vs. frequency

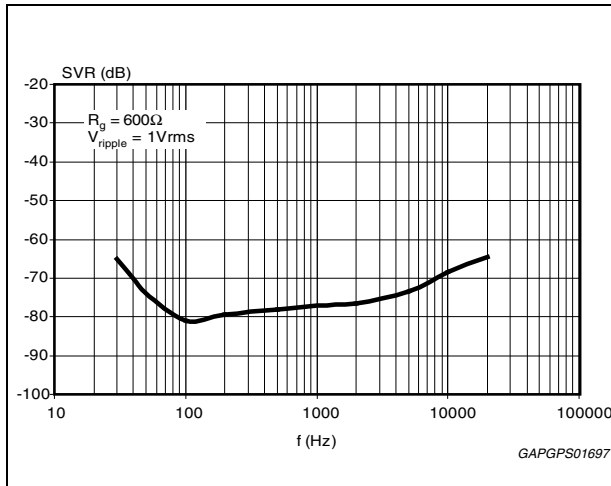

Figure 13. Output attenuation vs. supply voltage

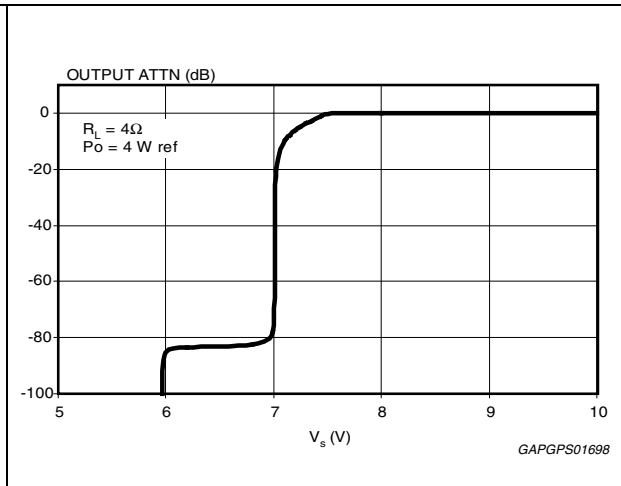

Figure 14. Power dissipation and efficiency vs. output power ($R_L = 4 \Omega$, SINE)

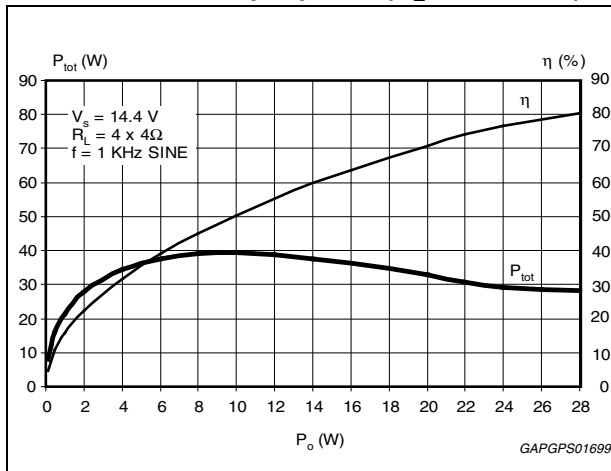

Figure 15. Power dissipation and efficiency vs. output power ($R_L = 2 \Omega$, SINE)

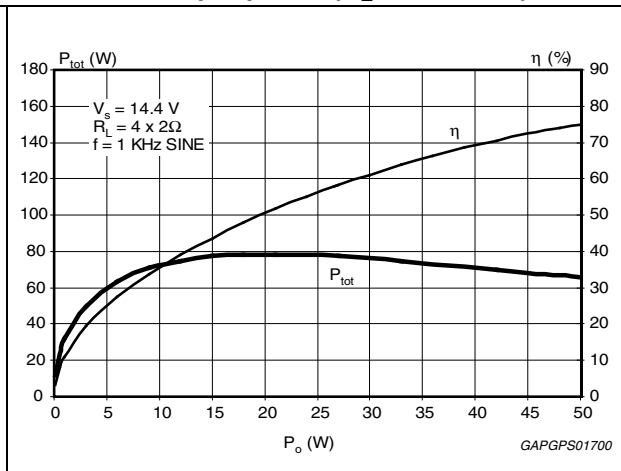

Figure 16. Power dissipation vs. output power ($R_L = 4 \Omega$, audio program simulation)

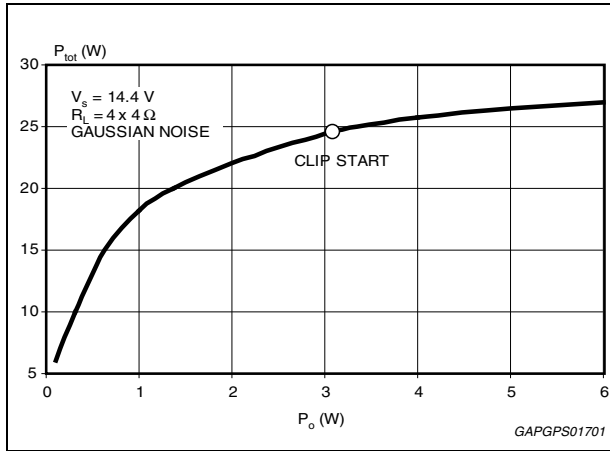

Figure 17. Power dissipation vs. output power ($R_L = 2 \Omega$, audio program simulation)

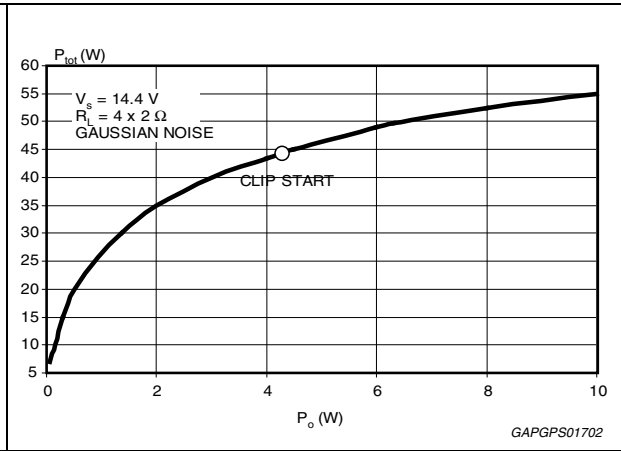
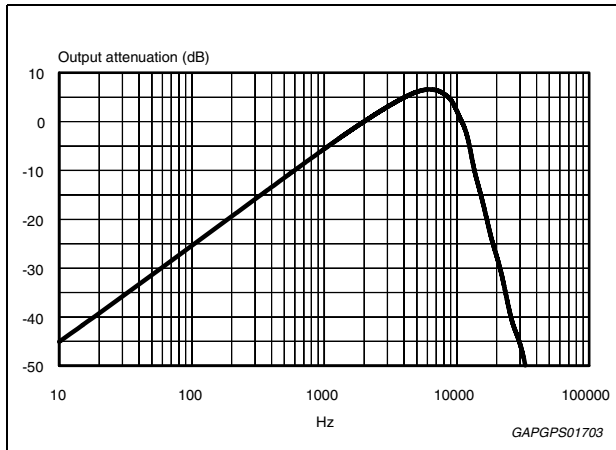

Figure 18. ITU R-ARM frequency response, weighting filter for transient pop



4 Application hints

4.1 DC offset detector

The TDA7851A integrates a DC offset detector to avoid that an anomalous DC offset on the inputs of the amplifier may be multiplied by the gain and result in a dangerous large offset on the outputs which may lead to speakers damage for overheating.

The feature works with the amplifier unmuted and no signal at the inputs.

4.2 SVR

Besides its contribution to the ripple rejection, the SVR capacitor governs the turn ON/OFF time sequence and, consequently, plays an essential role in the pop optimization during ON/OFF transients. To conveniently serve both needs, **its minimum recommended value is 10 μ F**.

4.3 Input stage

The TDA7851A's inputs are ground-compatible and can stand very high input signals (± 8 Vpk) without any performance degradation.

If the standard value for the input capacitors (0.1 μ F) is adopted, the low frequency cut-off amounts to 16 Hz.

The input capacitors should be 1/4 of the capacitor connected to AC-GND pin for optimum pop performance.

4.4 Standby and muting

Standby and muting facilities are both CMOS-compatible. In absence of true CMOS ports or microprocessors, a direct connection to V_s of these two pins is admissible but a 470 k Ω equivalent resistance should present between the power supply and the muting and standby pins.

R-C cells have always to be used in order to smooth down the transitions for preventing any audible transient noises.

About the standby, the time constant to be assigned in order to obtain a virtually pop-free transition has to be slower than 2.5 V/ms.

4.5 Heatsink definition

Under normal usage (4 Ω speakers) the heatsink's thermal requirements have to be deduced from [Figure 16](#), which reports the simulated power dissipation when real music/speech programmes are played out. Noise with gaussian-distributed amplitude was employed for this simulation. Based on that, frequent clipping occurrence (worst-case) causes $P_{\text{diss}} = 26$ W. Assuming $T_{\text{amb}} = 70^\circ\text{C}$ and $T_{\text{CHIP}} = 150^\circ\text{C}$ as boundary conditions, the heatsink's thermal resistance should be approximately 2 $^\circ\text{C/W}$. This would avoid any thermal shutdown occurrence even after long-term and full-volume operation.

5 Package information

In order to meet environmental requirements, ST offers these devices in different grades of ECOPACK® packages, depending on their level of environmental compliance. ECOPACK® specifications, grade definitions and product status are available at: www.st.com.

ECOPACK® is an ST trademark.

Figure 19. Flexiwatt27 mechanical data and package dimensions

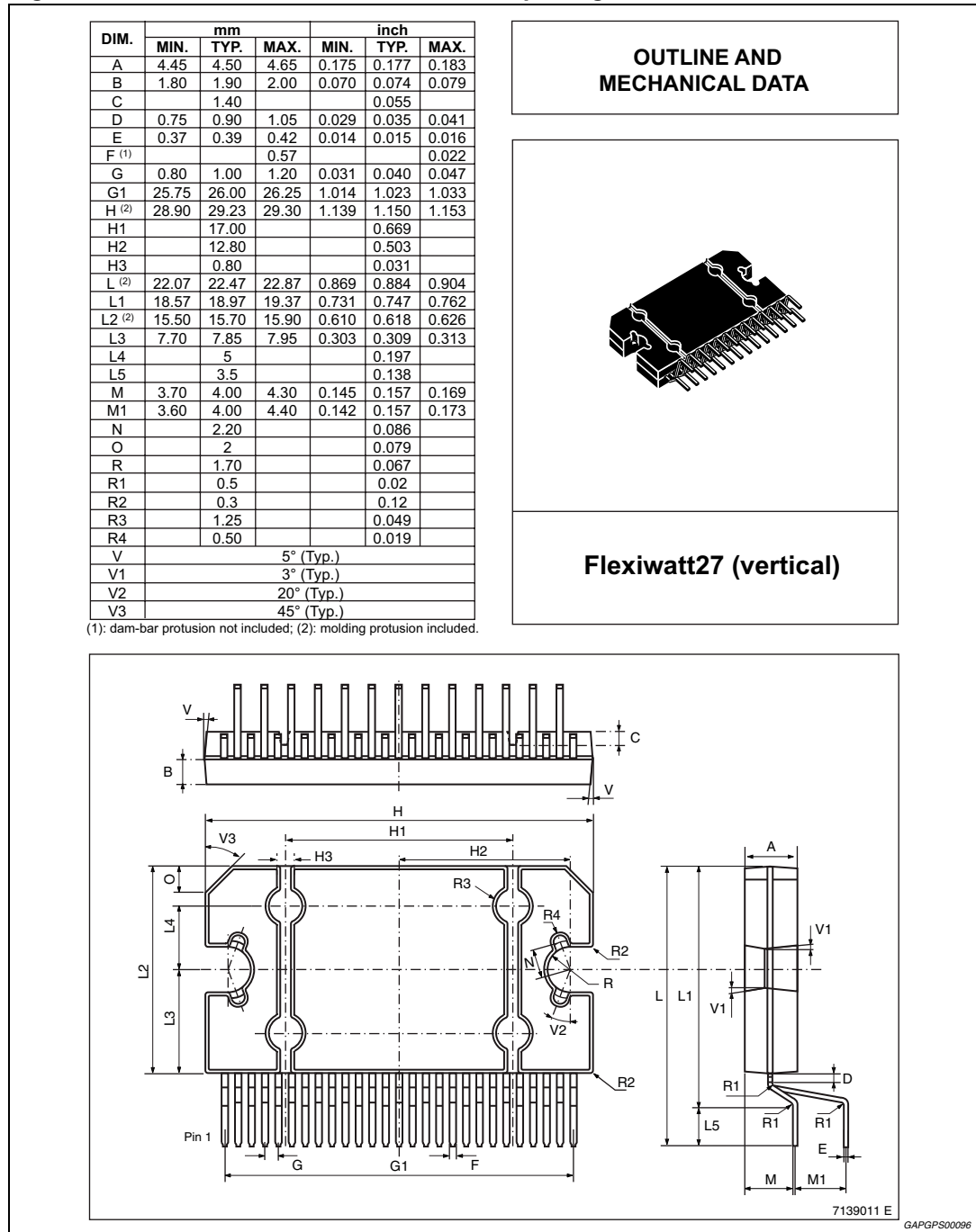

6 Revision history

Table 5. Document revision history

| Date | Revision | Changes |
|-------------|----------|---|
| 09-Jul-2010 | 1 | Initial release. |
| 13-Jun-2012 | 2 | Updated Features on page 1 ; Updated Section 3.2: Electrical characteristics on page 7 . |
| 18-Sep-2013 | 3 | Updated Disclaimer. |

Please Read Carefully:

Information in this document is provided solely in connection with ST products. STMicroelectronics NV and its subsidiaries ("ST") reserve the right to make changes, corrections, modifications or improvements, to this document, and the products and services described herein at any time, without notice.

All ST products are sold pursuant to ST's terms and conditions of sale.

Purchasers are solely responsible for the choice, selection and use of the ST products and services described herein, and ST assumes no liability whatsoever relating to the choice, selection or use of the ST products and services described herein.

No license, express or implied, by estoppel or otherwise, to any intellectual property rights is granted under this document. If any part of this document refers to any third party products or services it shall not be deemed a license grant by ST for the use of such third party products or services, or any intellectual property contained therein or considered as a warranty covering the use in any manner whatsoever of such third party products or services or any intellectual property contained therein.

UNLESS OTHERWISE SET FORTH IN ST'S TERMS AND CONDITIONS OF SALE ST DISCLAIMS ANY EXPRESS OR IMPLIED WARRANTY WITH RESPECT TO THE USE AND/OR SALE OF ST PRODUCTS INCLUDING WITHOUT LIMITATION IMPLIED WARRANTIES OF MERCHANTABILITY, FITNESS FOR A PARTICULAR PURPOSE (AND THEIR EQUIVALENTS UNDER THE LAWS OF ANY JURISDICTION), OR INFRINGEMENT OF ANY PATENT, COPYRIGHT OR OTHER INTELLECTUAL PROPERTY RIGHT.

ST PRODUCTS ARE NOT DESIGNED OR AUTHORIZED FOR USE IN: (A) SAFETY CRITICAL APPLICATIONS SUCH AS LIFE SUPPORTING, ACTIVE IMPLANTED DEVICES OR SYSTEMS WITH PRODUCT FUNCTIONAL SAFETY REQUIREMENTS; (B) AERONAUTIC APPLICATIONS; (C) AUTOMOTIVE APPLICATIONS OR ENVIRONMENTS, AND/OR (D) AEROSPACE APPLICATIONS OR ENVIRONMENTS. WHERE ST PRODUCTS ARE NOT DESIGNED FOR SUCH USE, THE PURCHASER SHALL USE PRODUCTS AT PURCHASER'S SOLE RISK, EVEN IF ST HAS BEEN INFORMED IN WRITING OF SUCH USAGE, UNLESS A PRODUCT IS EXPRESSLY DESIGNATED BY ST AS BEING INTENDED FOR "AUTOMOTIVE, AUTOMOTIVE SAFETY OR MEDICAL" INDUSTRY DOMAINS ACCORDING TO ST PRODUCT DESIGN SPECIFICATIONS. PRODUCTS FORMALLY ESCC, QML OR JAN QUALIFIED ARE DEEMED SUITABLE FOR USE IN AEROSPACE BY THE CORRESPONDING GOVERNMENTAL AGENCY.

Resale of ST products with provisions different from the statements and/or technical features set forth in this document shall immediately void any warranty granted by ST for the ST product or service described herein and shall not create or extend in any manner whatsoever, any liability of ST.

ST and the ST logo are trademarks or registered trademarks of ST in various countries.

Information in this document supersedes and replaces all information previously supplied.

The ST logo is a registered trademark of STMicroelectronics. All other names are the property of their respective owners.

© 2013 STMicroelectronics - All rights reserved



STMicroelectronics group of companies

Australia - Belgium - Brazil - Canada - China - Czech Republic - Finland - France - Germany - Hong Kong - India - Israel - Italy - Japan - Malaysia - Malta - Morocco - Philippines - Singapore - Spain - Sweden - Switzerland - United Kingdom - United States of America

www.st.com

Looking for pricing, stock, or lifecycle information?

Click below to explore more details on WIN SOURCE:

-  [View TDA7851A](#) on WIN SOURCE
-  [STMicroelectronics](#) Information

Optimize Your Supply Chain with WIN SOURCE Solutions

-  Global Sourcing Solution
-  Obsolete Management
-  Cost Control Management
-  Shortage Management
-  Alternative Solution
-  Excess Inventory Management