



**THE DATASHEET OF  
H11A2SR2M**





# 4N25M, 4N26M, 4N27M, 4N28M, 4N35M, 4N36M, 4N37M, H11A1M, H11A2M, H11A3M, H11A4M, H11A5M General Purpose 6-Pin Phototransistor Optocouplers

## Features

- UL recognized (File # E90700, Volume 2)
- VDE recognized (File # 102497)
  - Add option V (e.g., 4N25VM)

## Applications

- Power supply regulators
- Digital logic inputs
- Microprocessor inputs

## Description

The general purpose optocouplers consist of a gallium arsenide infrared emitting diode driving a silicon phototransistor in a 6-pin dual in-line package.

## Schematic

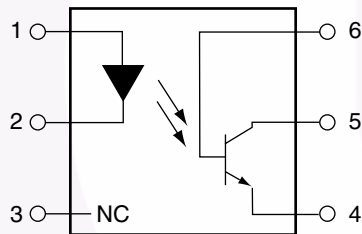

- PIN 1. ANODE  
2. CATHODE  
3. NO CONNECTION  
4. EMITTER  
5. COLLECTOR  
6. BASE

## Package Outlines

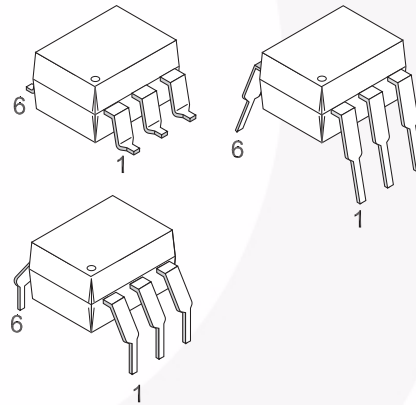

**Absolute Maximum Ratings** ( $T_A = 25^\circ\text{C}$  unless otherwise specified)

Stresses exceeding the absolute maximum ratings may damage the device. The device may not function or be operable above the recommended operating conditions and stressing the parts to these levels is not recommended. In addition, extended exposure to stresses above the recommended operating conditions may affect device reliability. The absolute maximum ratings are stress ratings only.

Symbol	Parameter	Value	Units
<b>TOTAL DEVICE</b>			
$T_{STG}$	Storage Temperature	-40 to +150	$^\circ\text{C}$
$T_{OPR}$	Operating Temperature	-40 to +100	$^\circ\text{C}$
$T_{SOL}$	Wave solder temperature (see page 8 for reflow solder profile)	260 for 10 sec	$^\circ\text{C}$
$P_D$	Total Device Power Dissipation @ $T_A = 25^\circ\text{C}$ Derate above $25^\circ\text{C}$	250	mW
		2.94	
<b>EMITTER</b>			
$I_F$	DC/Average Forward Input Current	60	mA
$V_R$	Reverse Input Voltage	6	V
$I_F(\text{pk})$	Forward Current – Peak (300 $\mu\text{s}$ , 2% Duty Cycle)	3	A
$P_D$	LED Power Dissipation @ $T_A = 25^\circ\text{C}$ Derate above $25^\circ\text{C}$	120	mW
		1.41	mW/ $^\circ\text{C}$
<b>DETECTOR</b>			
$V_{CEO}$	Collector-Emitter Voltage	30	V
$V_{CBO}$	Collector-Base Voltage	70	V
$V_{ECO}$	Emitter-Collector Voltage	7	V
$P_D$	Detector Power Dissipation @ $T_A = 25^\circ\text{C}$ Derate above $25^\circ\text{C}$	150	mW
		1.76	mW/ $^\circ\text{C}$

**Electrical Characteristics** ( $T_A = 25^\circ\text{C}$  unless otherwise specified)**Individual Component Characteristics**

Symbol	Parameter	Test Conditions	Min.	Typ.*	Max.	Unit
<b>EMITTER</b>						
$V_F$	Input Forward Voltage	$I_F = 10\text{mA}$		1.18	1.50	V
$I_R$	Reverse Leakage Current	$V_R = 6.0\text{V}$		0.001	10	$\mu\text{A}$
<b>DETECTOR</b>						
$BV_{CEO}$	Collector-Emitter Breakdown Voltage	$I_C = 1.0\text{mA}$ , $I_F = 0$	30	100		V
$BV_{CBO}$	Collector-Base Breakdown Voltage	$I_C = 100\mu\text{A}$ , $I_F = 0$	70	120		V
$BV_{ECO}$	Emitter-Collector Breakdown Voltage	$I_E = 100\mu\text{A}$ , $I_F = 0$	7	10		V
$I_{CEO}$	Collector-Emitter Dark Current	$V_{CE} = 10\text{V}$ , $I_F = 0$		1	50	nA
$I_{CBO}$	Collector-Base Dark Current	$V_{CB} = 10\text{V}$			20	nA
$C_{CE}$	Capacitance	$V_{CE} = 0\text{V}$ , $f = 1\text{MHz}$		8		pF

**Isolation Characteristics**

Symbol	Characteristic	Test Conditions	Min.	Typ.*	Max.	Units
$V_{ISO}$	Input-Output Isolation Voltage	$f = 60\text{Hz}$ , $t = 1\text{sec}$	7500			Vac(pk)
$R_{ISO}$	Isolation Resistance	$V_{I-O} = 500\text{VDC}$	$10^{11}$			$\Omega$
$C_{ISO}$	Isolation Capacitance	$V_{I-O} = \&$ , $f = 1\text{MHz}$		0.2	2	pF

\*Typical values at  $T_A = 25^\circ\text{C}$

**Electrical Characteristics** (Continued) ( $T_A = 25^\circ\text{C}$  unless otherwise specified)

**Transfer Characteristics**

Symbol	Parameter	Test Conditions	Device	Min.	Typ.*	Max.	Unit
<b>DC CHARACTERISTICS</b>							
CTR	Current Transfer Ratio, Collector to Emitter	$I_F = 10\text{mA}, V_{CE} = 10\text{V}$	4N35M, 4N36M, 4N37M	100			%
			H11A1M	50			
			H11A5M	30			
			4N25M, 4N26M H11A2M, H11A3M	20			
			4N27M, 4N28M H11A4M	10			
		$I_F = 10\text{mA}, V_{CE} = 10\text{V}, T_A = -55^\circ\text{C}$	4N35M, 4N36M, 4N37M	40			
		$I_F = 10\text{mA}, V_{CE} = 10\text{V}, T_A = +100^\circ\text{C}$	4N35M, 4N36M, 4N37M	40			
$V_{CE(SAT)}$	Collector-Emitter Saturation Voltage	$I_C = 2\text{mA}, I_F = 50\text{mA}$	4N25M, 4N26M, 4N27M, 4N28M,			0.5	V
		$I_C = 0.5\text{mA}, I_F = 10\text{mA}$	4N35M, 4N36M, 4N37M			0.3	
			H11A1M, H11A2M, H11A3M, H11A4M, H11A5M			0.4	
<b>AC CHARACTERISTICS</b>							
$T_{ON}$	Non-Saturated Turn-on Time	$I_F = 10\text{mA}, V_{CC} = 10\text{V}, R_L = 100\Omega$ (Fig. 11)	4N25M, 4N26M, 4N27M, 4N28M, H11A1M, H11A2M, H11A3M, H11A4, H11A5M		2		$\mu\text{s}$
		$I_C = 2\text{mA}, V_{CC} = 10\text{V}, R_L = 100\Omega$ (Fig. 11)	4N35M, 4N36M, 4N37M		2	10	$\mu\text{s}$
$T_{OFF}$	Turn-off Time	$I_F = 10\text{mA}, V_{CC} = 10\text{V}, R_L = 100\Omega$ (Fig. 11)	4N25M, 4N26M, 4N27M, 4N28M, H11A1M, H11A2M, H11A3M, H11A4M, H11A5M		2		$\mu\text{s}$
		$I_C = 2\text{mA}, V_{CC} = 10\text{V}, R_L = 100\Omega$ (Fig. 11)	4N35M, 4N36M, 4N37M		2	10	

\* Typical values at  $T_A = 25^\circ\text{C}$

## Typical Performance Curves

**Fig. 1 LED Forward Voltage vs. Forward Current**

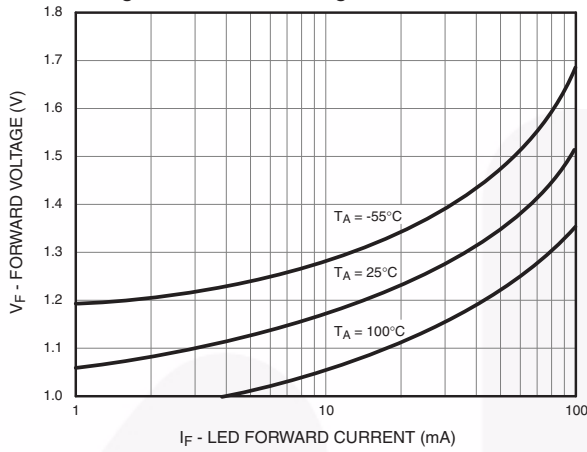

**Fig. 2 Normalized CTR vs. Forward Current**

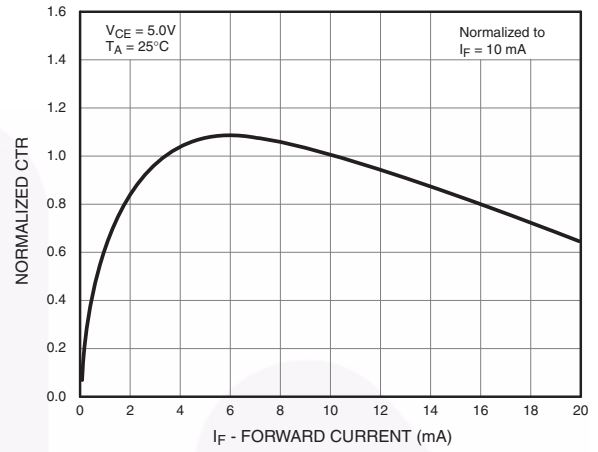

**Fig. 3 Normalized CTR vs. Ambient Temperature**

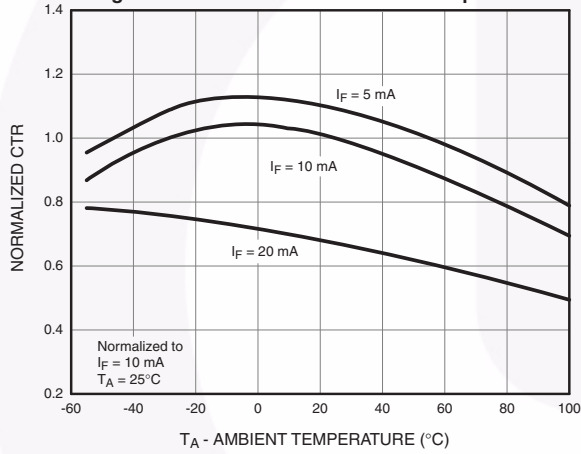

**Fig. 4 CTR vs. RBE (Unsaturated)**

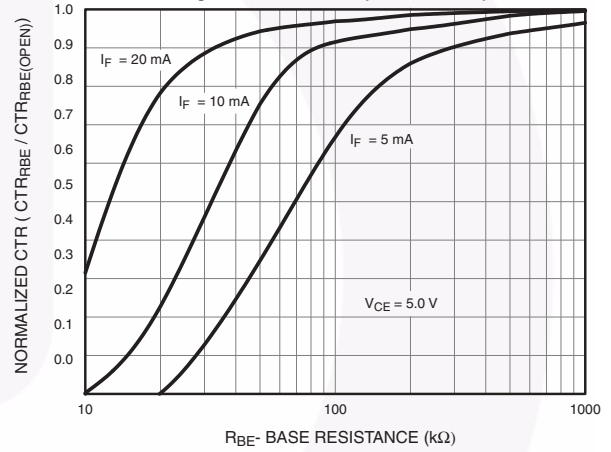

**Fig. 5 CTR vs. RBE (Saturated)**



**Fig. 6 Collector-Emitter Saturation Voltage vs. Collector Current**

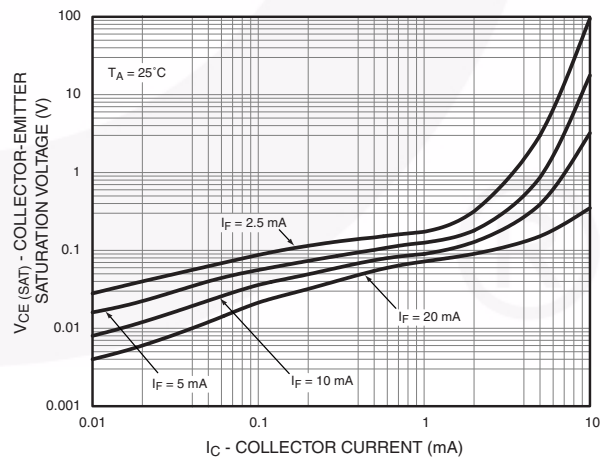

## Typical Performance Curves (Continued)

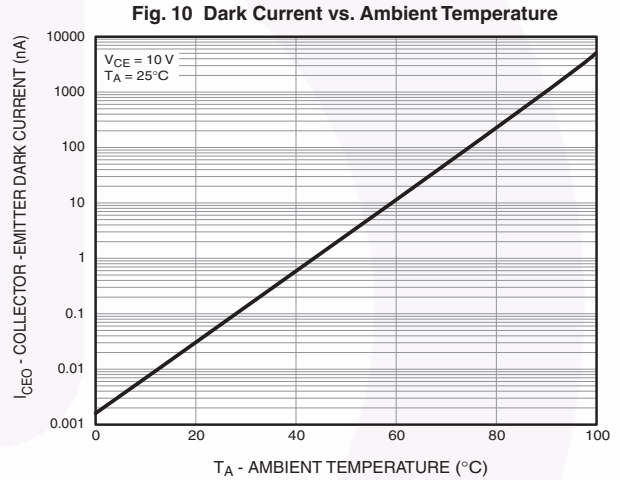
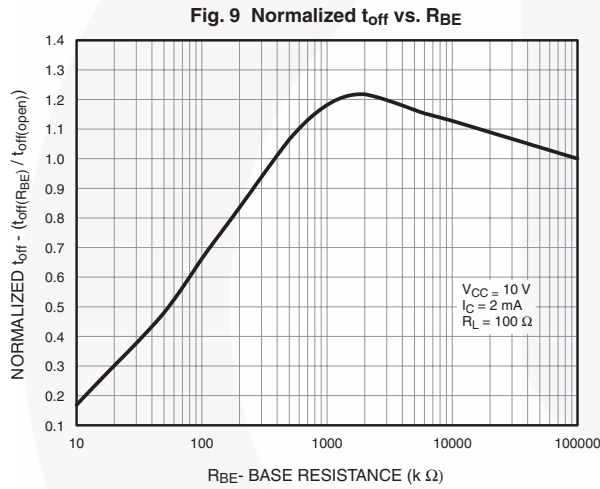

**Figure 11. Switching Time Test Circuit and Waveforms**

## Package Dimensions

### Through Hole



### 0.4" Lead Spacing

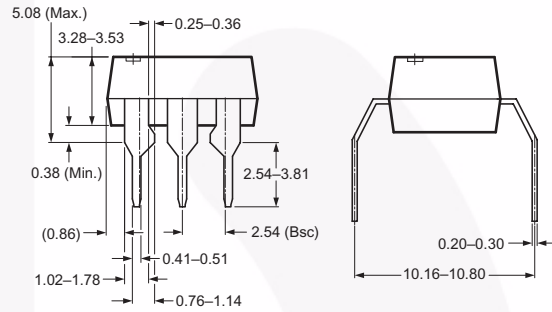
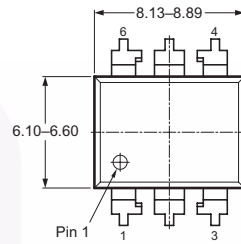

### Surface Mount

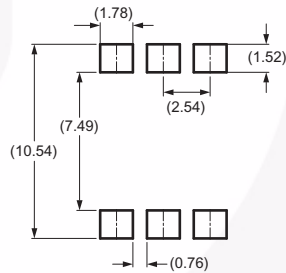
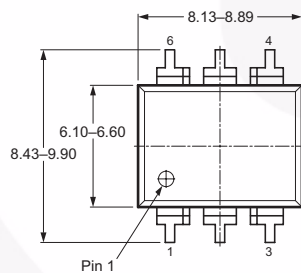

Recommended Pad Layout

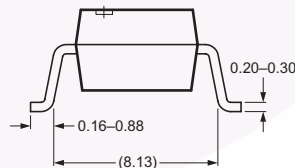

**Note:**  
All dimensions in mm.

## Ordering Information

Option	Order Entry Identifier (Example)	Description
No option	4N25M	Standard Through Hole Device
S	4N25SM	Surface Mount Lead Bend
SR2	4N25SR2M	Surface Mount; Tape and Reel
T	4N25TM	0.4" Lead Spacing
V	4N25VM	VDE 0884
TV	4N25TVM	VDE 0884, 0.4" Lead Spacing
SV	4N25SVM	VDE 0884, Surface Mount
SR2V	4N25SR2VM	VDE 0884, Surface Mount, Tape and Reel

## Marking Information

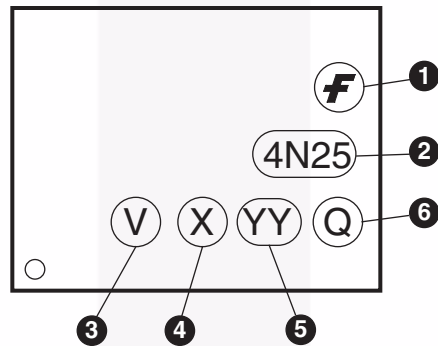

Definitions	
1	Fairchild logo
2	Device number
3	VDE mark (Note: Only appears on parts ordered with VDE option – See order entry table)
4	One digit year code, e.g., '7'
5	Two digit work week ranging from '01' to '53'
6	Assembly package code

\*Note – Parts that do not have the 'V' option (see definition 3 above) that are marked with date code '325' or earlier are marked in portrait format.





**TRADEMARKS**

The following includes registered and unregistered trademarks and service marks, owned by Fairchild Semiconductor and/or its global subsidiaries, and is not intended to be an exhaustive list of all such trademarks.

- |  |   |  |   |
|--|---|--|---|
| Build it Now™  | FRFET®  | Programmable Active Droop™   | the power franchise   |
| CorePLUS™  | Global Power Resource SM  | QFET®  | TinyBoost™  |
| CorePOWER™   | Green FPS™  | QS™  | TinyBuck™   |
| CROSSVOLT™   | Green FPS™ e-Series™  | Quiet Series™  | TinyLogic®  |
| CTL™   | GTO™  | RapidConfigure™  | TINYOPTO™   |
| Current Transfer Logic™  | IntelliMAX™   |  TM             | TinyPower™  |
| EcoSPARK®  | ISOPLANAR™  | Saving our world, 1mW/W/kW at a time™  | TinyPWM™  |
| EfficientMax™  | MegaBuck™   | SmartMax™  | TinyWire™   |
| EZSWITCH™ *  | MICROCOUPLER™   | SMART START™   | TriFault Detect™  |
|  TM | MicroFET™   | SPM®   | µSerDes™  |
|  ®  | MicroPak™   | STEALTH™   |  SerDes® |
| Fairchild®   | MillerDrive™  | SuperFET™  | UHC®  |
| Fairchild Semiconductor®   | MotionMax™  | SuperSOT™-3  | Ultra FRFET™  |
| FACT Quiet Series™   | Motion-SPM™   | SuperSOT™-6  | UnifET™   |
| FACT®  | OPTOLOGIC®  | SuperSOT™-8  | VCX™  |
| FAST®  | OPTOPLANAR®   | SupreMOS™  | VisualMax™  |
| FastvCore™   |  ® | SyncFET™   | XS™   |
| FlashWriter® *   | PDP SPM™  |  SYSTEM GENERAL |   |
| FPS™   | Power-SPM™  | The Power Franchise®   |   |
| F-PFS™   | PowerTrench®  |  |   |
|  | PowerXS™  |  |   |

\* EZSWITCH™ and FlashWriter® are trademarks of System General Corporation, used under license by Fairchild Semiconductor.

**DISCLAIMER**

FAIRCHILD SEMICONDUCTOR RESERVES THE RIGHT TO MAKE CHANGES WITHOUT FURTHER NOTICE TO ANY PRODUCTS HEREIN TO IMPROVE RELIABILITY, FUNCTION, OR DESIGN. FAIRCHILD DOES NOT ASSUME ANY LIABILITY ARISING OUT OF THE APPLICATION OR USE OF ANY PRODUCT OR CIRCUIT DESCRIBED HEREIN; NEITHER DOES IT CONVEY ANY LICENSE UNDER ITS PATENT RIGHTS, NOR THE RIGHTS OF OTHERS. THESE SPECIFICATIONS DO NOT EXPAND THE TERMS OF FAIRCHILD'S WORLDWIDE TERMS AND CONDITIONS, SPECIFICALLY THE WARRANTY THEREIN, WHICH COVERS THESE PRODUCTS.

**LIFE SUPPORT POLICY**

FAIRCHILD'S PRODUCTS ARE NOT AUTHORIZED FOR USE AS CRITICAL COMPONENTS IN LIFE SUPPORT DEVICES OR SYSTEMS WITHOUT THE EXPRESS WRITTEN APPROVAL OF FAIRCHILD SEMICONDUCTOR CORPORATION.

As used herein:

1. Life support devices or systems are devices or systems which, (a) are intended for surgical implant into the body or (b) support or sustain life, and (c) whose failure to perform when properly used in accordance with instructions for use provided in the labeling, can be reasonably expected to result in a significant injury of the user.
2. A critical component in any component of a life support, device, or system whose failure to perform can be reasonably expected to cause the failure of the life support device or system, or to affect its safety or effectiveness.

**ANTI-COUNTERFEITING POLICY**

Fairchild Semiconductor Corporation's Anti-Counterfeiting Policy. Fairchild's Anti-Counterfeiting Policy is also stated on our external website, [www.fairchildsemi.com](http://www.fairchildsemi.com), under Sales Support.

Counterfeiting of semiconductor parts is a growing problem in the industry. All manufacturers of semiconductor products are experiencing counterfeiting of their parts. Customers who inadvertently purchase counterfeit parts experience many problems such as loss of brand reputation, substandard performance, failed applications, and increased cost of production and manufacturing delays. Fairchild is taking strong measures to protect ourselves and our customers from the proliferation of counterfeit parts. Fairchild strongly encourages customers to purchase Fairchild parts either directly from Fairchild or from Authorized Fairchild Distributors who are listed by country on our web page cited above. Products customers buy either from Fairchild directly or from Authorized Fairchild Distributors are genuine parts, have full traceability, meet Fairchild's quality standards for handling and storage and provide access to Fairchild's full range of up-to-date technical and product information. Fairchild and our Authorized Distributors will stand behind all warranties and will appropriately address any warranty issues that may arise. Fairchild will not provide any warranty coverage or other assistance for parts bought from Unauthorized Sources. Fairchild is committed to combat this global problem and encourage our customers to do their part in stopping this practice by buying direct or from authorized distributors.

**PRODUCT STATUS DEFINITIONS**



**Definition of Terms**

Datasheet Identification	Product Status	Definition
Advance Information	Formative / In Design	Datasheet contains the design specifications for product development. Specifications may change in any manner without notice.
Preliminary	First Production	Datasheet contains preliminary data; supplementary data will be published at a later date. Fairchild Semiconductor reserves the right to make changes at any time without notice to improve design.
No Identification Needed	Full Production	Datasheet contains final specifications. Fairchild Semiconductor reserves the right to make changes at any time without notice to improve the design.
Obsolete	Not In Production	Datasheet contains specifications on a product that is discontinued by Fairchild Semiconductor. The datasheet is for reference information only.

Rev. 138

## Looking for pricing, stock, or lifecycle information?

Click below to explore more details on WIN SOURCE:

-  [View H11A2SR2M on WIN SOURCE](#)
-  [Fairchild/ON Semiconductor](#) Information

## Optimize Your Supply Chain with WIN SOURCE Solutions

-  Global Sourcing Solution
-  Obsolete Management
-  Cost Control Management
-  Shortage Management
-  Alternative Solution
-  Excess Inventory Management