

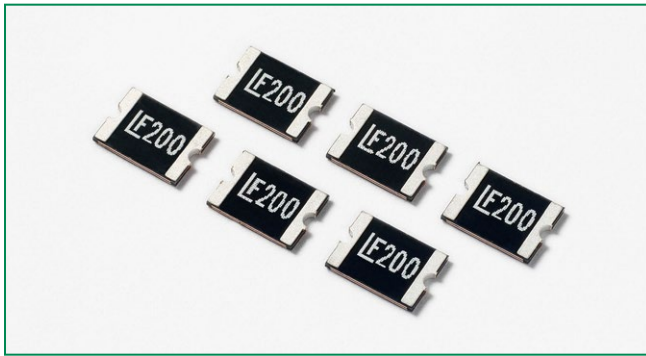

**THE DATASHEET OF
1812L014DR**



1812L Series



Description

The 1812L Series PTC provides surface mount overcurrent protection for applications where resettable protection is desired.

Features

- RoHS compliant, lead-free and halogen-free
- Fast response
- Compact design
- Low resistance
- Low-profile
- Compatible with high temperature solders

Applications

- Plug and play protection for motherboards and peripherals
- USB peripherals
- PCI cards
- Game console port protection

Agency Approvals

AGENCY	AGENCY FILE NUMBER
	E183209
	R50119118

Electrical Characteristics

Part Number	Marking	I _{hold} (A)	I _{trip} (A)	V _{max} (Vdc)	I _{max} (A)	P _d typ. (W)	Max. Time To Trip		Resistance		Agency Approvals	
							Current (A)	Time (Sec.)	R _{min} (Ω)	R _{1max} (Ω)		
1812L010	LF010	0.10	0.30	30	100	0.8	0.50	1.50	1.600	15.000	X	X
1812L010/60	LF010-60	0.10	0.30	60	10	0.8	0.50	1.50	1.600	15.000	X	X
1812L014	LF014	0.14	0.34	60	10	0.8	1.50	0.15	1.500	6.000	X	X
1812L020	LF020	0.20	0.40	30	100	0.8	8.00	0.02	0.800	5.000	X	X
1812L020/60	LF020-60	0.20	0.40	60	40	0.8	1.00	2.00	1.400	4.400	X	X
1812L035/30	LF035-30	0.35	0.75	30	40	0.8	8.00	0.15	0.400	1.700	X	X
1812L035/60	LF035-60	0.35	0.70	60	10	1.00	8.00	0.15	0.400	1.700	X	X
1812L050 ¹	LF050	0.50	1.00	15	100	0.8	8.00	0.15	0.150	1.000	X	X
1812L050/30	LF050-30	0.50	1.00	30	100	0.8	8.00	0.15	0.150	1.000	X	X
1812L050/60	LF050-60	0.50	1.00	60	10	1.50	8.00	0.15	0.150	1.000	X	X
1812L075 ¹	LF075	0.75	1.50	13.2	100	0.8	8.00	0.20	0.100	0.450	X	X
1812L075/24 ²	LF075-24	0.75	1.50	24	100	0.8	8.00	0.20	0.110	0.290	X	X
1812L075/33	LF075-33	0.75	1.50	33	20	0.8	8.00	0.20	0.110	0.400	X	X
1812L110 ¹	LF110	1.10	2.20	8	100	0.8	8.00	0.30	0.040	0.210	X	X
1812L110/16	LF110-16	1.10	1.95	16	100	0.8	8.00	0.30	0.060	0.180	X	X
1812L110/24	LF110-24	1.10	1.95	24	20	0.8	8.00	0.50	0.060	0.200	X	X
1812L110/33	LF110-33	1.10	1.95	33	20	0.8	8.00	0.50	0.060	0.200	X	X
1812L125/6	LF125-6	1.25	2.50	6	100	0.8	8.00	0.40	0.050	0.140	X	X
1812L125/16	LF125	1.25	2.50	16	100	0.8	8.00	0.40	0.050	0.140	X	X
1812L150 ¹	LF150	1.50	3.00	8	100	0.8	8.00	0.30	0.040	0.110	X	X
1812L150/12	LF150-12	1.50	3.00	12	100	0.8	8.00	0.50	0.040	0.110	X	X
1812L150/16	LF150-16	1.50	2.80	16	100	0.8	8.00	0.50	0.040	0.110	X	X
1812L150/24 ²	LF150-24	1.50	3.00	24	20	0.8	8.00	1.50	0.040	0.120	X	X
1812L160 ¹	LF160	1.60	2.80	8	100	0.8	8.00	1.00	0.030	0.100	X	X
1812L160/12	LF160-12	1.60	2.80	12	100	0.8	8.00	1.00	0.030	0.100	X	X
1812L200TH ¹	LF200	2.00	3.50	8	100	0.8	8.00	2.00	0.020	0.070	X	X

continues on next page.

I_{hold} = Hold current: maximum current device will pass without tripping in 20°C still air.
 I_{trip} = Trip current: minimum current at which the device will trip in 20°C still air.
 V_{max} = Maximum voltage device can withstand without damage at rated current (I_{max})
 I_{max} = Maximum fault current device can withstand without damage at rated voltage (V_{max})
 P_d = Power dissipated from device when in the tripped state at 20°C still air.

R_{min} = Minimum resistance of device in initial (un-soldered) state.
 R_{typ} = Typical resistance of device in initial (un-soldered) state.
 R_{1max} = Maximum resistance of device at 20°C measured one hour after tripping or reflow soldering of 260°C for 20 sec.

Caution: Operation beyond the specified rating may result in damage and possible arcing and flame.

1 Some older references to these devices may include "-C" in the Part Number. The "-C" should be omitted when placing new orders for the device.
 2 Part Number with note 2 tested and complied with AEC Q200.

Electrical Characteristics

Part Number	Marking	I _{hold} (A)	I _{trip} (A)	V _{max} (Vdc)	I _{max} (A)	P _d typ. (W)	Max. Time To Trip		Resistance		Agency Approvals	
							Current (A)	Time (Sec.)	R _{min} (Ω)	R _{1max} (Ω)	UL US	TÜV
1812L200/12	LF200-12	2.00	3.50	12	100	1.0	8.00	2.00	0.020	0.070	X	X
1812L200/16	LF200-16	2.00	3.50	16	100	1.0	8.00	2.00	0.020	0.070	X	X
1812L260TH ¹	LF260	2.60	5.20	8	100	0.8	8.00	2.50	0.015	0.047	X	X
1812L260/12	LF260-12	2.60	5.00	12	100	0.8	8.00	5.00	0.015	0.055	X	X
1812L260/16	LF260-16	2.60	5.00	16	100	1.2	8.00	5.00	0.015	0.050	X	X
1812L300	LF300	3.00	5.00	6	100	0.8	8.00	4.00	0.012	0.040	X	X

I_{hold} = Hold current: maximum current device will pass without tripping in 20°C still air.
 I_{trip} = Trip current: minimum current at which the device will trip in 20°C still air.
 V_{max} = Maximum voltage device can withstand without damage at rated current (I_{max})
 I_{max} = Maximum fault current device can withstand without damage at rated voltage (V_{max})
 P_d = Power dissipated from device when in the tripped state at 20°C still air.
 R_{min} = Minimum resistance of device in initial (un-soldered) state.
 R_{typ} = Typical resistance of device in initial (un-soldered) state.
 R_{1max} = Maximum resistance of device at 20°C measured one hour after tripping or reflow soldering of 260°C for 20 sec.

Caution: Operation beyond the specified rating may result in damage and possible arcing and flame.

- 1 Some older references to these devices may include “-C” in the Part Number. The “-C” should be omitted when placing new orders for the device.
- 2 Part Number with note 2 tested and complied with AEC Q200.

Temperature Derating

Ambient Operation Temperature									
Part Number	-40°C	-20°C	0°C	20°C	40°C	50°C	60°C	70°C	85°C
	Hold Current (A)								
1812L010	0.16	0.14	0.12	0.10	0.08	0.07	0.06	0.05	0.03
1812L010/60	0.16	0.14	0.12	0.10	0.08	0.07	0.06	0.05	0.03
1812L014	0.23	0.19	0.17	0.14	0.12	0.10	0.09	0.08	0.06
1812L020	0.29	0.26	0.23	0.20	0.17	0.15	0.14	0.12	0.10
1812L020/60	0.29	0.26	0.23	0.20	0.17	0.15	0.14	0.12	0.10
1812L035/30	0.50	0.45	0.40	0.35	0.30	0.26	0.24	0.20	0.16
1812L035/60	0.50	0.46	0.40	0.35	0.30	0.26	0.24	0.20	0.16
1812L050	0.77	0.68	0.59	0.50	0.44	0.40	0.37	0.33	0.29
1812L050/30	0.77	0.68	0.59	0.50	0.44	0.40	0.37	0.33	0.29
1812L050/60	0.77	0.68	0.59	0.50	0.44	0.40	0.37	0.33	0.29
1812L075	1.15	1.01	0.88	0.75	0.65	0.60	0.55	0.49	0.43
1812L075/24	1.06	0.95	0.84	0.75	0.60	0.55	0.50	0.45	0.37
1812L075/33	1.10	1.00	0.88	0.75	0.66	0.60	0.56	0.47	0.36
1812L110	1.59	1.43	1.26	1.10	0.95	0.87	0.80	0.71	0.60
1812L110/16	1.58	1.43	1.27	1.10	0.95	0.85	0.77	0.71	0.58
1812L110/24	1.55	1.40	1.25	1.10	0.93	0.83	0.73	0.63	0.50
1812L110/33	1.55	1.40	1.25	1.10	0.93	0.83	0.73	0.63	0.50
1812L125/6	2.00	1.75	1.52	1.25	1.00	0.95	0.90	0.75	0.53
1812L125/16	2.00	1.75	1.52	1.25	1.00	0.95	0.90	0.75	0.53
1812L150	2.06	1.93	1.79	1.50	1.28	1.10	1.02	0.80	0.68
1812L150/12	2.04	1.88	1.68	1.50	1.25	1.10	1.00	0.80	0.60
1812L150/16	2.04	1.88	1.68	1.50	1.25	1.10	1.00	0.80	0.60
1812L150/24	2.05	1.87	1.67	1.50	1.25	1.08	0.95	0.77	0.60
1812L160	2.20	2.06	1.91	1.60	1.36	1.17	1.09	0.85	0.72
1812L160/12	2.20	2.06	1.91	1.60	1.36	1.17	1.09	0.85	0.72
1812L200TH	2.60	2.44	2.22	2.00	1.78	1.67	1.50	1.45	1.29
1812L200/12	2.60	2.44	2.22	2.00	1.78	1.67	1.50	1.45	1.29
1812L200/16	2.60	2.44	2.22	2.00	1.78	1.67	1.50	1.45	1.29
1812L260TH	3.40	3.16	3.00	2.60	2.30	2.15	2.00	1.85	1.63
1812L260/12	3.40	3.16	3.00	2.60	2.30	2.15	2.00	1.85	1.63
1812L260/16	3.40	3.16	3.30	2.60	2.30	2.15	2.00	1.85	1.63
1812L300	4.13	3.75	3.30	3.00	2.62	2.43	2.25	2.00	1.78

Notes: The temperature derating data is only for reference, please contact Littelfuse technical support for detail temperature derating information.

Temperature Derating Curve

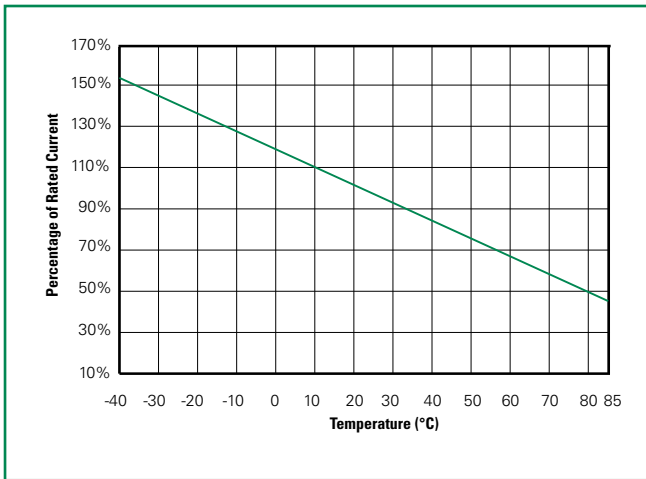

Note:
Typical Temperature derating curve, refer to table for derating data

Physical Specifications

Terminal Material	Solder-Plated Copper (Solder Material: Matte Tin (Sn))
Lead Solderability	Meets EIA Specification RS186-9E, ANSI/J-STD-002 Category 3.

Environmental Specifications

Operating/Storage Temp.	-40°C to +85°C
Max. Device Surface Temp. in Tripped State	125°C
Passive Aging	+85°C, 1000 hours -/+5% typical resistance change
Humidity Aging	+85°C, 85% R.H., 1000 hours -/+5% typical resistance change
Thermal Shock	MIL-STD-202, Method 107 +85°C/-40°C 20 times -30% typical resistance change
Solvent Resistance	MIL-STD-202, Method 215, No change
Vibration	MIL-STD-883, Method 2007, Condition A, No change
Moisture Level Sensitivity	Level 1, J-STD-020

Soldering Parameters

Profile Feature	Pb-Free Assembly	
Average Ramp-Up Rate ($T_{S(max)}$ to T_p)	3°C/second max	
Pre Heat:	Temperature Min ($T_{S(min)}$)	150°C
	Temperature Max ($T_{S(max)}$)	200°C
	Time (Min to Max) (t_s)	60 – 180 secs
Time Maintained Above:	Temperature (T_L)	217°C
	Temperature (t_L)	60 – 150 seconds
Peak / Classification Temperature (T_p)	260 ^{+0/-5} °C	
Time within 5°C of actual peak Temperature (t_p)	20 – 40 seconds	
Ramp-down Rate	6°C/second max	
Time 25°C to peak Temperature (T_p)	8 minutes Max.	

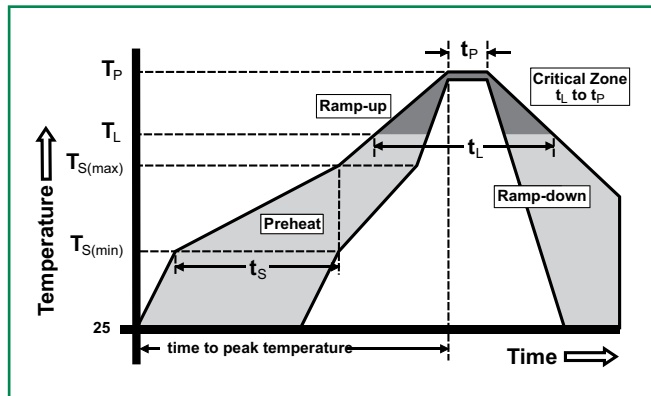

- All temperature refer to topside of the package, measured on the package body surface
- If reflow temperature exceeds the recommended profile, devices may not meet the performance requirements
- Recommended reflow methods: IR, vapor phase oven, hot air oven, N₂ environment for lead
- Recommended maximum paste thickness is 0.25mm (0.010inch)
- Devices can be cleaned using standard industry methods and solvents
- Devices can be reworked using the standard industry practices

Average Time Current Curves

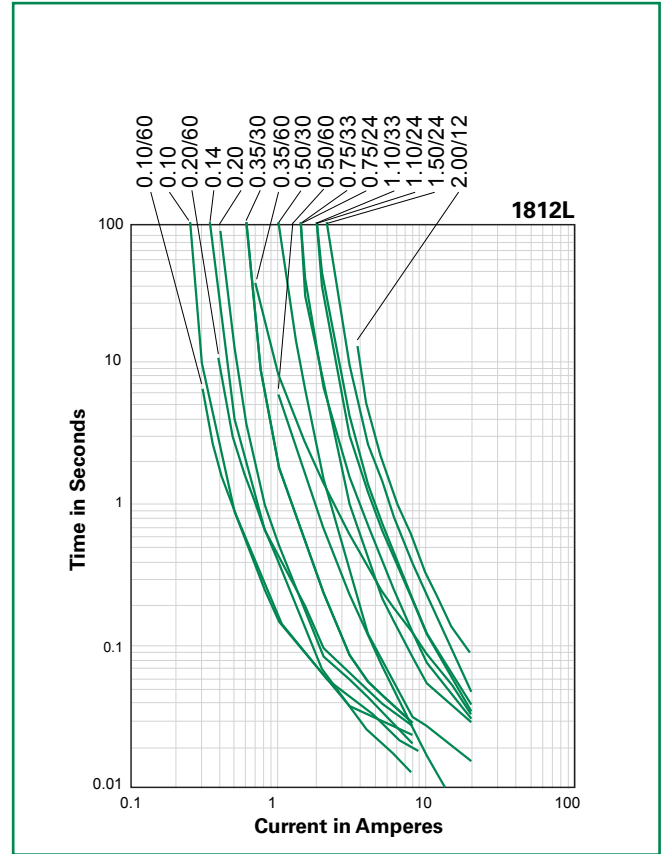
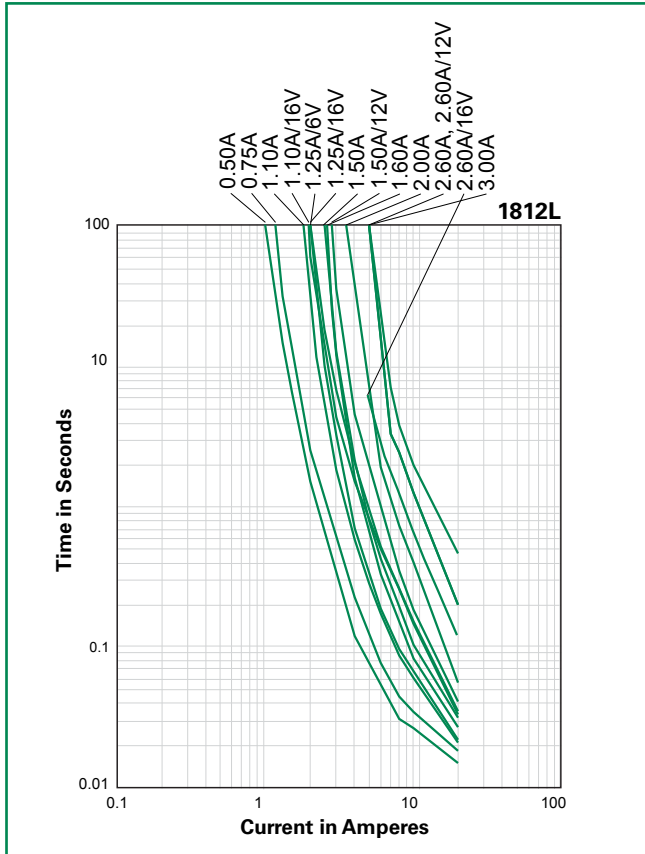

The average time current curves and Temperature Rerating curve performance is affected by a number of variables, and these curves provided as guidance only. Customer must verify the performance in their application.

Additional Information



Datasheet



Resources



Samples

Dimensions

MARKING CODE VARIES
WITH AMPERAGE AND VOLTAGE RATING
(See Electrical Characteristics Table)
SHOWN ARE:
- 1.1A/6V RATING (LEFT)
- 1.1A/33V RATING (RIGHT)

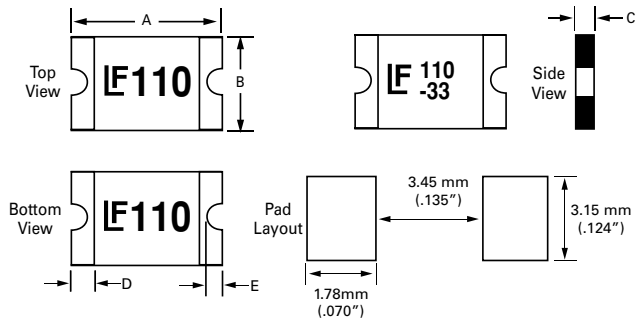

Part Number	A				B				C				D				E			
	Inches		mm		Inches		mm		Inches		mm		Inches		mm		Inches		mm	
	Min	Max	Min	Max	Min	Max	Min	Max	Min	Max	Min	Max	Min	Max	Min	Max	Min	Max	Min	Max
1812L010	0.17	0.19	4.37	4.73	0.12	0.13	3.07	3.41	0.03	0.05	0.75	1.25	0.01	0.05	0.3	1.2	0.01	0.03	0.15	0.65
1812L010/60	0.17	0.19	4.37	4.73	0.12	0.13	3.07	3.41	0.03	0.05	0.75	1.25	0.01	0.05	0.3	1.2	0.01	0.03	0.15	0.65
1812L014	0.17	0.19	4.37	4.73	0.12	0.13	3.07	3.41	0.03	0.08	0.75	1.95	0.01	0.05	0.3	1.2	0.01	0.03	0.15	0.65
1812L020	0.17	0.19	4.37	4.73	0.12	0.13	3.07	3.41	0.02	0.04	0.55	1.00	0.01	0.05	0.3	1.2	0.01	0.03	0.15	0.65
1812L020/60	0.17	0.19	4.37	4.73	0.12	0.13	3.07	3.41	0.03	0.05	0.75	1.25	0.01	0.05	0.3	1.20	0.01	0.03	0.15	0.65
1812L035/30	0.17	0.19	4.37	4.73	0.12	0.13	3.07	3.41	0.02	0.04	0.6	1.25	0.01	0.05	0.3	1.20	0.01	0.03	0.15	0.65
1812L035/60	0.17	0.19	4.37	4.73	0.12	0.13	3.07	3.41	0.05	0.07	1.2	1.8	0.01	0.05	0.3	1.2	0.01	0.03	0.15	0.65
1812L050	0.17	0.19	4.37	4.73	0.12	0.13	3.07	3.41	0.02	0.03	0.5	0.75	0.01	0.05	0.3	1.2	0.01	0.02	0.15	0.50
1812L050/30	0.17	0.19	4.37	4.73	0.12	0.13	3.07	3.41	0.02	0.04	0.5	1.00	0.01	0.05	0.3	1.2	0.01	0.03	0.15	0.65
1812L050/60	0.17	0.19	4.37	4.73	0.12	0.13	3.07	3.41	0.05	0.07	1.2	1.8	0.01	0.05	0.3	1.2	0.01	0.03	0.15	0.65
1812L075	0.17	0.19	4.37	4.73	0.12	0.13	3.07	3.41	0.02	0.03	0.5	0.75	0.01	0.05	0.3	1.2	0.01	0.02	0.15	0.50
1812L075/24	0.17	0.19	4.37	4.73	0.12	0.13	3.07	3.41	0.03	0.05	0.75	1.20	0.01	0.05	0.3	1.2	0.01	0.03	0.15	0.65
1812L075/33	0.17	0.19	4.37	4.73	0.12	0.13	3.07	3.41	0.03	0.06	0.75	1.55	0.01	0.05	0.3	1.2	0.01	0.03	0.15	0.65
1812L110	0.17	0.19	4.37	4.73	0.12	0.13	3.07	3.41	0.02	0.03	0.50	0.71	0.01	0.05	0.3	1.2	0.01	0.02	0.15	0.65
1812L110/24	0.17	0.19	4.37	4.73	0.12	0.13	3.07	3.41	0.02	0.04	0.50	1.07	0.01	0.05	0.3	1.2	0.01	0.03	0.15	0.65
1812L110/16	0.17	0.19	4.37	4.73	0.12	0.13	3.07	3.41	0.03	0.05	0.75	1.25	0.01	0.05	0.3	1.2	0.01	0.03	0.15	0.65
1812L110/33	0.17	0.19	4.37	4.73	0.12	0.13	3.07	3.41	0.05	0.08	1.20	2.00	0.01	0.05	0.3	1.2	0.01	0.03	0.15	0.65
1812L125/6	0.17	0.19	4.37	4.73	0.12	0.13	3.07	3.41	0.02	0.03	0.45	0.75	0.01	0.05	0.3	1.2	0.01	0.03	0.15	0.65
1812L125/16	0.17	0.19	4.37	4.73	0.12	0.13	3.07	3.41	0.03	0.05	0.75	1.25	0.01	0.05	0.3	1.2	0.01	0.02	0.15	0.65
1812L150	0.17	0.19	4.37	4.73	0.12	0.13	3.07	3.41	0.02	0.03	0.30	0.71	0.01	0.05	0.3	1.2	0.01	0.03	0.15	0.65
1812L150/12	0.17	0.19	4.37	4.73	0.12	0.13	3.07	3.41	0.03	0.05	0.75	1.25	0.01	0.05	0.3	1.2	0.01	0.03	0.15	0.65
1812L150/16	0.17	0.19	4.37	4.73	0.12	0.13	3.07	3.41	0.03	0.05	0.75	1.25	0.01	0.05	0.3	1.2	0.01	0.03	0.15	0.65
1812L150/24	0.17	0.19	4.37	4.73	0.12	0.13	3.07	3.41	0.03	0.07	0.80	1.8	0.01	0.05	0.3	1.2	0.01	0.03	0.15	0.65
1812L160	0.17	0.19	4.37	4.73	0.12	0.13	3.07	3.41	0.02	0.03	0.40	0.75	0.01	0.05	0.3	1.2	0.01	0.03	0.15	0.65
1812L160/12	0.17	0.19	4.37	4.73	0.12	0.13	3.07	3.41	0.03	0.05	0.75	1.25	0.01	0.05	0.3	1.2	1.2	0.01	0.15	0.65
1812L200TH	0.17	0.19	4.37	4.73	0.12	0.13	3.07	3.41	0.008	0.024	0.20	0.6	0.01	0.05	0.3	1.2	0.01	0.02	0.15	0.65
1812L200/12	0.17	0.19	4.37	4.73	0.12	0.13	3.07	3.41	0.03	0.05	0.80	1.20	0.012	0.047	0.3	1.2	0.01	0.026	0.15	0.65
1812L200/16	0.17	0.19	4.37	4.73	0.12	0.13	3.07	3.41	0.03	0.05	0.80	1.20	0.012	0.047	0.3	1.2	0.01	0.026	0.15	0.65
1812L260TH	0.17	0.19	4.37	4.73	0.12	0.13	3.07	3.41	0.02	0.04	0.50	1.00	0.01	0.05	0.3	1.2	0.01	0.02	0.15	0.65
1812L260/12	0.17	0.19	4.37	4.73	0.12	0.13	3.07	3.41	0.03	0.05	0.80	1.34	0.01	0.05	0.3	1.2	0.01	0.03	0.15	0.65
1812L260/16	0.18	0.19	4.54	4.90	0.12	0.14	3.16	3.50	0.05	0.08	1.20	2.00	0.012	0.047	0.3	1.2	0.006	0.03	0.15	0.65
1812L300	0.17	0.19	4.37	4.73	0.12	0.13	3.07	3.41	0.02	0.06	0.50	1.50	0.01	0.05	0.3	1.2	0.01	0.03	0.15	0.65

Part Ordering Number System

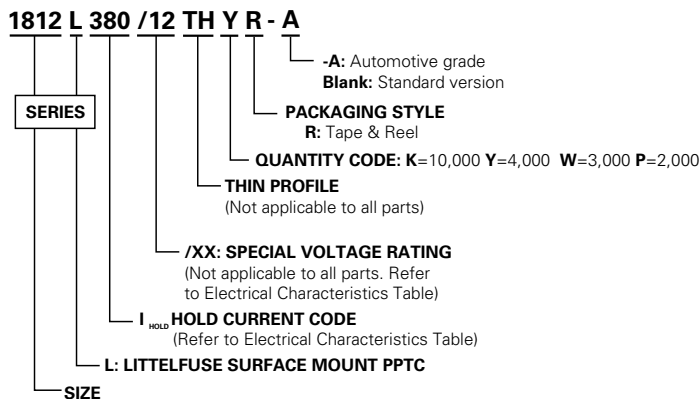

Packaging

Part Number	Ordering Number	Halogen Free	I _{hold} (A)	I _{hold} Code	Voltage Option	Packaging Option	Quantity	Quantity & Packaging Code
1812L010	1812L010DR	Yes	0.10	010		Tape and Reel	1500	DR
1812L010/60	1812L010/60DR	Yes	0.10	010	/60		1500	DR
1812L014	1812L014DR	Yes	0.14	014			1500	DR
1812L020	1812L020PR	Yes	0.20	020			2000	PR
1812L020/60	1812L020/60DR	Yes	0.20	020	/60		1500	DR
1812L035/30	1812L035/30DR	Yes	0.35	035	/30		1500	DR
1812L035/60	1812L035/60	Yes	0.35	035	/60		1000	MR
1812L050	1812L050PR	Yes	0.50	050			2000	PR
1812L050/30	1812L050/30PR	Yes	0.50	050	/30		2000	PR
1812L050/60	1812L050/60	Yes	0.50	050	/60		1000	MR
1812L075	1812L075PR	Yes	0.75	075			2000	PR
1812L75/24	1812L075/24DR	Yes	0.75	075	/24		1500	DR
1812L75/33	1812L075/33DR	Yes	0.75	075	/33		1500	DR
1812L110	1812L110PR	Yes	1.10	110			2000	PR
1812L110/16	1812L110/16DR	Yes	1.10	110	/16		1500	DR
1812L110/24	1812L110/24DR	Yes	1.10	1.10	/24		1500	DR
1812L110/33	1812L110/33MR	Yes	1.10	110	/33		1000	MR
1812L125/6	1812L125/6PR	Yes	1.25	125	/6		2000	PR
1812L125/16	1812L125/16DR	Yes	1.25	125	/16		1500	DR
1812L150	1812L150ZR	Yes	1.50	150			2000	ZR
1812L150/12	1812L150/12DR	Yes	1.50	150	/12		1500	DR
1812L150/16	1812L150/16DR	Yes	1.50	150	/16		1500	DR
1812L150/24	1812L150/24MR	Yes	1.50	150	/24		1000	MR
1812L160	1812L160PR	Yes	1.60	160			2000	PR
1812L160/12	1812L160/12DR	Yes	1.60	160	/12		1500	DR
1812L200TH	1812L200THPR	Yes	2.00	200			2000	PR
1812L200/12	1812L200/12DR	Yes	2.00	200	/12		1500	DR
1812L200/16	1812L200/16DR	Yes	2.00	200			1500	DR
1812L260TH	1812L260THDR	Yes	2.60	260			1500	DR
1812L260/12	1812L260/12MR	Yes	2.60	260	/12		1000	MR
1812L260/16	1812L260/16MR	Yes	2.60	260			1000	MR
1812L300	1812L300MR	Yes	3.00	300			1000	MR

WARNING

- Users shall independently assess the suitability of these devices for each of their applications
- Operation of these devices beyond the stated maximum ratings could result in damage to the devices and lead to electrical arcing and/or fire
- These devices are intended to protect against the effects of temporary over-current or over-temperature conditions and are not intended to perform as protective devices where such conditions are expected to be repetitive or prolonged in duration
- Exposure to silicon-based oils, solvents, electrolytes, acids, and similar materials can adversely affect the performance of these PPTC devices
- These devices undergo thermal expansion under fault conditions, and thus shall be provided with adequate space and be protected against mechanical stresses
- Circuits with inductance may generate a voltage (L di/dt) above the rated voltage of the PPTC device.

Tape and Reel Specifications

TAPE SPECIFICATIONS: EIA-481-1 (mm)				REEL DIMENSIONS: EIA-481-1 (mm)	
	1812L020 1812L050/30 1812L050 1812L075 1812L110 1812L125/6 1812L150 1812L160 1812L200	1812L010 1812L010/60 1812L014 1812L020/60 1812L035/30 1812L075/24 1812L075/33 1812L110/16 1812L110/24 1812L125/16 1812L150/12 1812L150/16 1812L160/12 1812L200/12 1812L200/16 1812L260	1812L035/60 1812L050/60 1812L110/33 1812L150/24 1812L260/12 1812L260/16 1812L300		
W	12.00 ± 0.30	12.00 ± 0.30	12.00 ± 0.30	C	Ø178 ± 1.0
F	5.50 ± 0.05	5.50 ± 0.05	5.50 ± 0.05	D	Ø60.2 ± 0.5
E₁	1.75 ± 0.10	1.75 ± 0.10	1.75 ± 0.10	H	16.0 ± 0.5
D₀	1.55 ± 0.10	1.55±/-0.05	1.55 ± 0.05	W	13.2 ± 1.5
D₁	1.55 (min)	1.50±/-0.10	1.50 (MIN)		
P₀	4.00 ± 0.10	4.00 ± 0.10	4.00 ± 0.08		
P₁	8.00 ± 0.10	8.00 ± 0.10	8.00 ± 0.10		
P₂	2.00 ± 0.05	2.00 ± 0.05	2.00 ± 0.05		
A₀	3.58 ± 0.10	3.50 ± 0.10	3.58 ± 0.10		
B₀	4.93 ± 0.10	4.85± 0.10	4.93 ± 0.10		
T	0.25 ± 0.10	0.25 ± 0.10	0.25 ± 0.10		
K₀	0.87 ± 0.06	1.25 ± 0.10	2.10 ± 0.10		
Leader min.	390	390	390		
Trailer min.	160	160	160		

Tape and Reel Diagram

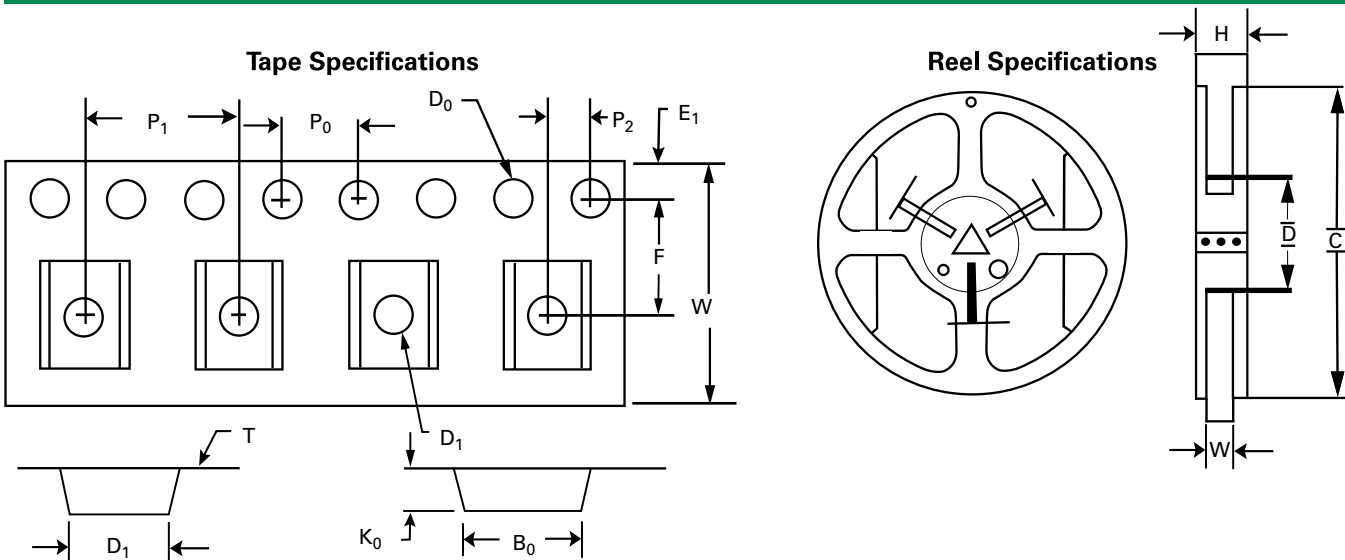

Disclaimer Notice - Information furnished is believed to be accurate and reliable. However, users should independently evaluate the suitability of and test each product selected for their own applications. Littelfuse products are not designed for, and may not be used in, all applications. Read complete Disclaimer Notice at www.littelfuse.com/disclaimer-electronics.

Looking for pricing, stock, or lifecycle information?

Click below to explore more details on WIN SOURCE:

 [View 1812L014DR on WIN SOURCE](#)

 [Littelfuse Inc. Information](#)

Optimize Your Supply Chain with WIN SOURCE Solutions

-  Global Sourcing Solution
-  Obsolete Management
-  Cost Control Management
-  Shortage Management
-  Alternative Solution
-  Excess Inventory Management