



MIC5239

Low Quiescent Current 500mA μ Cap LDO Regulator

General Description

The MIC5239 is a low quiescent current, μ Cap low-dropout regulator. With a maximum operating input voltage of 30V and a quiescent current of 23 μ A, it is ideal for supplying keep-alive power in systems with high voltage batteries.

Capable of 500mA output, the MIC5239 has a dropout voltage of only 350mV. It can provide high output current for applications such as USB.

As a μ Cap LDO, the MIC5239 is stable with either a ceramic or a tantalum output capacitor. It only requires a 3.3 μ F output capacitor for stability.

The MIC5239 includes a logic compatible enable input and an undervoltage error flag indicator. Other features of the MIC5239 include thermal shutdown, current limit, overvoltage shutdown, reverse-leakage protection, and reverse-battery protection.

Available in the thermally enhanced SOIC-8, MSOP-8 and SOT-223, the MIC5239 comes in fixed 1.5V, 1.8V, 2.5V, 3.0V, 3.3V and 5.0V, and adjustable voltages. For other output voltages, contact Micrel.

All support documentation can be found on Micrel's web site at: www.micrel.com.

Features

- Ultra-low quiescent current ($I_Q = 23\mu\text{A} @ I_O = 100\mu\text{A}$)
- Continuous 500mA output current
- Wide input range: 2.3V to 30V
- Low dropout voltage: 350mV @500mA
- $\pm 1.0\%$ initial output accuracy
- Stable with ceramic or tantalum output capacitor
- Logic compatible enable input
- Low output voltage error flag indicator
- Overcurrent protection
- Thermal shutdown
- Reverse-leakage protection
- Reverse-battery protection
- High-power SOIC-8, MSOP-8 and SOT-223 packages

Applications

- USB power supply
- Keep-alive supply in notebook and portable personal computers
- Logic supply from high voltage batteries
- Automotive electronics
- Battery-powered systems

Typical Application



Regulator with Low I_O and Low I_Q



Ground Current vs. Input Voltage

Ordering Information

Part Number		Voltage ⁽¹⁾	Junction Temp. Range	Package
Standard	Pb-Free			
MIC5239-1.5BM	MIC5239-1.5YM	1.5V	-40°C to +125°C	8-pin SOIC
MIC5239-1.5BMM	MIC5239-1.5YMM	1.5V	-40°C to +125°C	8-pin MSOP
MIC5239-1.5BS	MIC5239-1.5YS	1.5V	-40°C to +125°C	SOT-223
MIC5239-1.8BM	MIC5239-1.8YM	1.8V	-40°C to +125°C	8-pin SOIC
MIC5239-1.8BMM	MIC5239-1.8YMM	1.8V	-40°C to +125°C	8-pin MSOP
MIC5239-1.8BS	MIC5239-1.8YS	1.8V	-40°C to +125°C	SOT-223
MIC5239-2.5BM	MIC5239-2.5YM	2.5V	-40°C to +125°C	8-pin SOIC
MIC5239-2.5BMM	MIC5239-2.5YMM	2.5V	-40°C to +125°C	8-pin MSOP
MIC5239-2.5BS	MIC5239-2.5YS	2.5V	-40°C to +125°C	SOT-223
MIC5239-3.0BM	MIC5239-3.0YM	3.0V	-40°C to +125°C	8-pin SOIC
MIC5239-3.0BMM	MIC5239-3.0YMM	3.0V	-40°C to +125°C	8-pin MSOP
MIC5239-3.0BS	MIC5239-3.0YS	3.0V	-40°C to +125°C	SOT-223
MIC5239-3.3BM	MIC5239-3.3YM	3.3V	-40°C to +125°C	8-pin SOIC
MIC5239-3.3BMM	MIC5239-3.3YMM	3.3V	-40°C to +125°C	8-pin MSOP
MIC5239-3.3BS	MIC5239-3.3YS	3.3V	-40°C to +125°C	SOT-223
MIC5239-5.0BM	MIC5239-5.0YM	5.0V	-40°C to +125°C	8-pin SOIC
MIC5239-5.0BMM	MIC5239-5.0YMM	5.0V	-40°C to +125°C	8-pin MSOP
MIC5239-5.0BS	MIC5239-5.0YS	5.0V	-40°C to +125°C	SOT-223
MIC5239BM	MIC5239YM	ADJ	-40°C to +125°C	8-pin SOIC
MIC5239BMM	MIC5239YMM	ADJ	-40°C to +125°C	8-pin MSOP

Note:

1. Other Voltages available. Contact Micrel for details.

Pin Configuration



Pin Description

Pin Number MSOP/SOIC	Pin Number SOT-223	Pin Name	Pin Function
2 (fixed)	—	FLG	Error FLAG (Output): Open-collector output is active low when the output is out of regulation due to insufficient input voltage or excessive load. An external pull-up resistor is required.
2 (adj)	—	ADJ	Adjustable Feedback Input: Connect to voltage divider network.
3	1	IN	Power Supply Input.
4	3	OUT	Regulated Output.
1	—	EN	Enable (input): Logic low = shutdown; logic high = enabled.
5–8	2	GND	Ground: Pins 5, 6, 7, and 8 are internally connected in common via the leadframe.

Absolute Maximum Ratings⁽¹⁾

Supply Voltage (V_{IN})	-20V to +32V
Enable Input Voltage (V_{EN})	-0.3V to +32V
Power Dissipation (P_D) ⁽³⁾	Internally Limited
Junction Temperature (T_J)	-40°C to +125°C
Storage Temperature (T_S)	-65°C to +150°C
Lead Temperature (soldering, 5 sec.)	260°C
ESD Rating ⁽⁴⁾	
SOT-23-3L	2kV
MSOP-8L	1.5kV

Operating Ratings⁽²⁾

Supply Voltage (V_{IN})	2.3V to 30V
Enable Input Voltage (V_{EN})	0V to 30V
Junction Temperature (T_J)	-40°C to +125°C
Package Thermal Resistance	
MSOP (θ_{JA})	80°C/W
SOT-223 (θ_{JA})	50°C/W

Electrical Characteristics⁽⁵⁾

$V_{IN} = V_{OUT} + 1V$; $V_{EN} \geq 2.0V$; $I_{OUT} = 100\mu A$; $T_J = 25^\circ C$, **bold** values indicate $-40^\circ C \leq T_J \leq +125^\circ C$; unless noted.

Symbol	Parameter	Condition	Min	Typ	Max	Units
V_{OUT}	Output Voltage Accuracy	Variation from nominal V_{OUT}	-1		1	%
			-2		2	%
$\Delta V_{OUT}/V_{OUT}$	Line Regulation	$V_{IN} = V_{OUT} + 1V$ to 30V		0.06	0.5	%
$\Delta V_{OUT}/V_{OUT}$	Load Regulation	$I_{OUT} = 100\mu A$ to 500mA ⁽⁶⁾		15	30	mV
ΔV	Dropout Voltage ⁽⁷⁾	$I_{OUT} = 100\mu A$		50		mV
		$I_{OUT} = 150mA$		260	350	mV
		$I_{OUT} = 500mA$		350	400	mV
I_{GND}	Ground Pin Current	$V_{EN} \geq 2.0V$, $I_{OUT} = 100\mu A$		23	40	μA
		$V_{EN} \geq 2.0V$, $I_{OUT} = 150mA$		1.3	5	mA
		$V_{EN} \geq 2.0V$, $I_{OUT} = 500mA$		8.5	15	mA
$I_{GND(SHDN)}$	Ground Pin Shutdown	$V_{EN} \leq 0.6V$, $V_{IN} = 30V$		0.1	1	μA
I_{SC}	Short Circuit Current	$V_{OUT} = 0V$		850	1200	mA
e_n	Output Noise	10Hz to 100kHz, $V_{OUT} = 3.0V$, $C_L = 3.3\mu F$		160		μV_{rms}
FLAG Output						
V_{FLG}	Low Threshold	% of V_{OUT}		94		%
	High Threshold	% of V_{OUT}		95		%
V_{OL}	FLAG Output Low Voltage	$V_{IN} = V_{OUT(nom)} - 0.12V_{OUT}$, $I_{OL} = 200\mu A$		150		mV
I_{LEAK}	FLAG Output Leakage	$V_{OH} = 30V$		0.1		μA
Enable Input						
V_{IL}	Input Low Voltage	regulator off			0.6	V
V_{IH}	Input High Voltage	regulator on	2.0			V
I_{IN}	Enable Input Current	$V_{EN} = 0.6V$, regulator off	-1.0	0.01	1.0	μA
		$V_{EN} = 2.0V$, regulator on	-2.0		2.0	μA
		$V_{EN} = 30V$, regulator on		0.15	1.0	μA
				0.5	2.5	μA
					5.0	μA

Notes:

1. Exceeding the absolute maximum rating may damage the device.
2. The device is not guaranteed to function outside its operating rating.
3. The maximum allowable power dissipation of any T_A (ambient temperature) is $P_D(\max) = (T_J(\max) - T_A) \div \theta_{JA}$. Exceeding the maximum allowable power dissipation will result in excessive die temperature, and the regulator will go into thermal shutdown. The θ_{JA} of the MIC5239-x.xBMM (all versions) is 80°C/W, the MIC5239-x.xBM (all versions) is 63°C/W, and the MIC5239-x.xBS (all versions) is 50°C/W mounted on a PC board, see "Thermal Characteristics" for further details.
4. Devices are ESD sensitive. Handling precautions recommended. Human body model, 1.5kΩ in series with 100pF.
5. Specification for packaged product only.
6. Regulation is measured at constant junction temperature using pulse testing with a low duty-cycle. Changes in output voltage due to heating effects are covered by the specification for thermal regulation.
7. Dropout voltage is defined as the input to output differential at which the output voltage drops 2% below its nominal value measured at 1.0V differential.

Typical Characteristics ($V_{OUT} = 3V$)

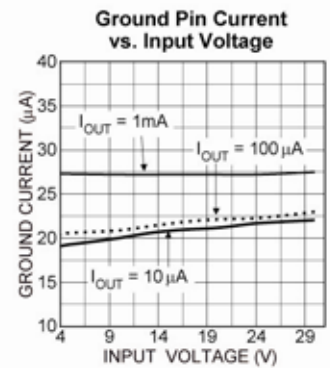
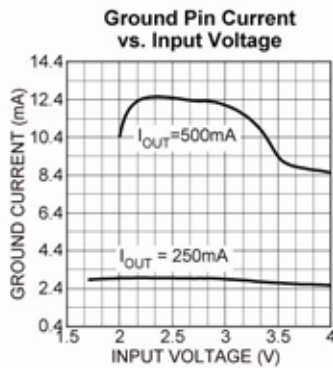
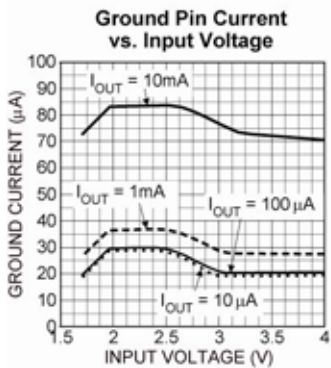
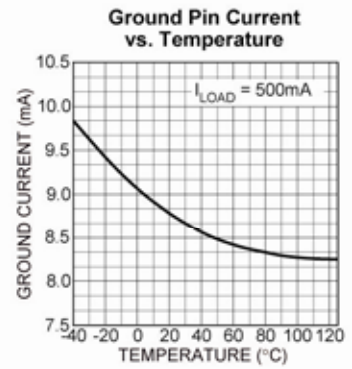
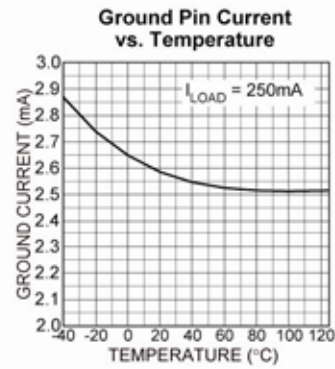
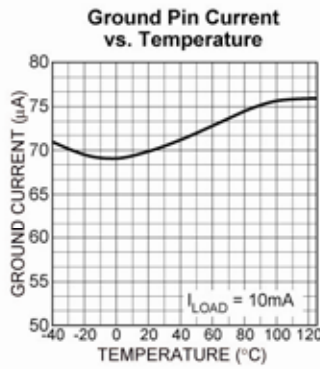
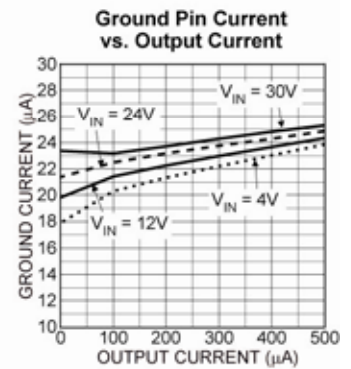

Typical Characteristics (continued) ($V_{OUT} = 3V$)

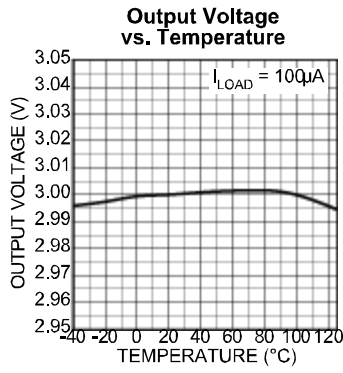
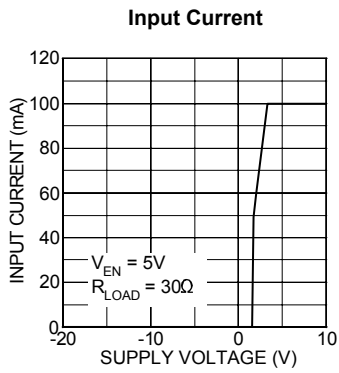

Functional Characteristics

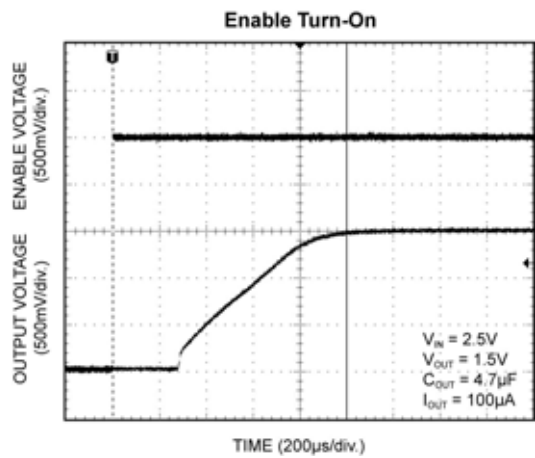
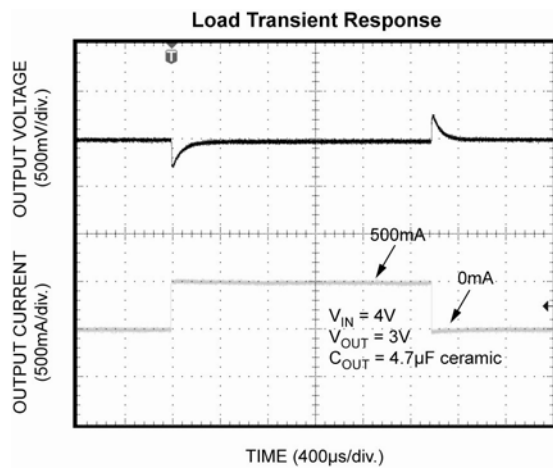

Functional Diagram

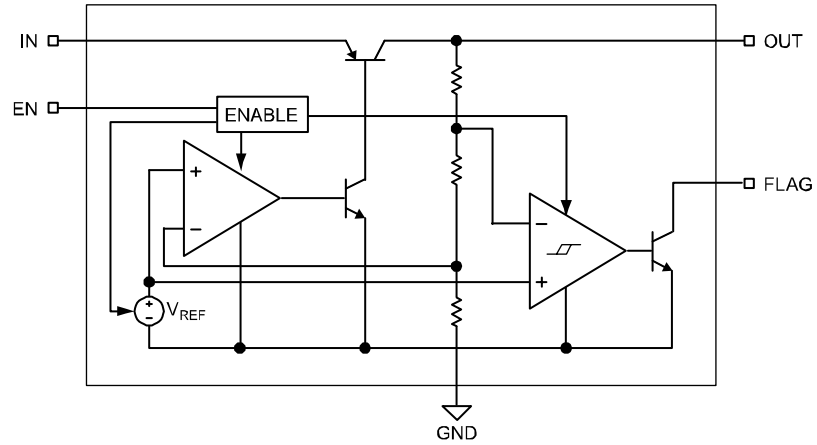

Block Diagram — Fixed Voltages

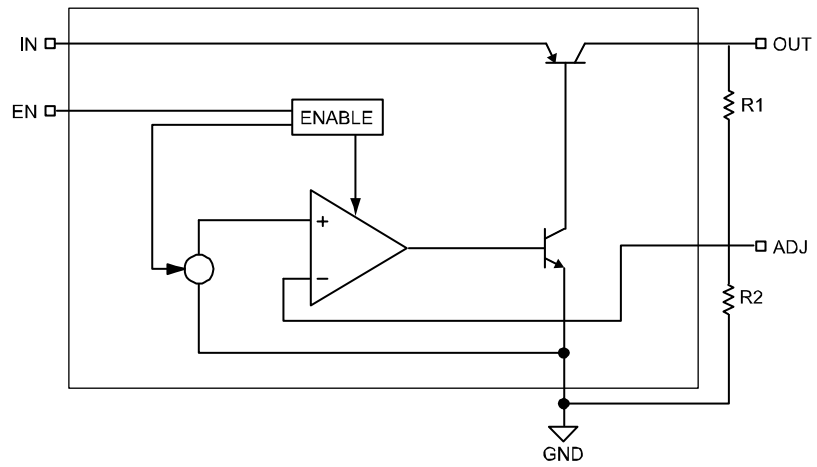

Block Diagram — Adjustable Voltages

Application Information

The MIC5239 provides all of the advantages of the MIC2950: wide input voltage range, and reversed-battery protection, with the added advantages of reduced quiescent current and smaller package. Additionally, when disabled, quiescent current is reduced to 0.1µA.

Enable

A low on the enable pin disables the part, forcing the quiescent current to less than 0.1µA. Thermal shutdown and the error flag are not functional while the device is disabled. The maximum enable bias current is 2µA for a 2.0V input. An open-collector pull-up resistor tied to the input voltage should be set low enough to maintain 2V on the enable input. Figure 1 shows an open-collector output driving the enable pin through a 200kΩ pull-up resistor tied to the input voltage.

In order to avoid output oscillations, slow transitions from low-to-high should be avoided.



Figure 1. Remote Enable

Input Capacitor

An input capacitor may be required when the device is not near the source power supply or when supplied by a battery. Small, surface mount ceramic capacitors can be used for bypassing. Larger values may be required if the source supply has high ripple.

Output Capacitor

The MIC5239 has been designed to minimize the effect of the output capacitor ESR on the closed loop stability. As a result, ceramic or film capacitors can be used at the output. Figure 2 displays a range of ESR values for a 10µF capacitor. Virtually any 10µF capacitor with an ESR less than 3.4Ω is sufficient for stability over the entire input voltage range. Stability can also be maintained throughout the specified load and line conditions with 4.7µF film or ceramic capacitors.



Figure 2. Output Capacitor ESR

Error Detection Comparator Output

The FLAG pin is an open-collector output which goes low when the output voltage drops 5% below its internally programmed level. It senses conditions such as excessive load (current limit), low input voltage, and over temperature conditions. Once the part is disabled via the enable input, the error flag output is not valid. Overvoltage conditions are not reflected in the error flag output. The error flag output is also not valid for input voltages less than 2.3V.

The error output has a low voltage of 400mV at a current of 200µA. In order to minimize the drain on the source used for the pull-up, a value of 200kΩ to 1MΩ is suggested for the error flag pull-up. This will guarantee a maximum low voltage of 0.4V for a 30V pull-up potential. An unused error flag can be left unconnected.



Figure 3. Error FLAG Output Timing

Thermal Shutdown

The MIC5239 has integrated thermal protection. This feature is only for protection purposes. The device should never be intentionally operated near this temperature as this may have detrimental effects on the life of the device. The thermal shutdown may become inactive while the enable input is transitioning from a high to a low. When disabling the device via the enable pin, transition from a high to low quickly. This will insure that the output remains disabled in the event of a thermal shutdown.

Current Limit

Figure 4 displays a method for reducing the steady state short-circuit current. The duration that the supply delivers current is set by the time required for the error flag output to discharge the 4.7µF capacitor tied to the enable pin. The off time is set by the 200kΩ resistor as it recharges the 4.7µF capacitor, enabling the regulator. This circuit reduces the short-circuit current from 800mA to 40mA while allowing for regulator restart once the short is removed.



Figure 4. Remote Enable with Short-Circuit Current Foldback

Thermal Characteristics

The MIC5239 is a high input voltage device, intended to provide 500mA of continuous output current in two very small profile packages. The power MSOP-8 allows the device to dissipate about 50% more power than their standard equivalents.

Power MSOP-8 Thermal Characteristics

One of the secrets of the MIC5239's performance is its power MSOP-8 package featuring half the thermal resistance of a standard MSOP-8 package. Lower thermal resistance means more output current or higher input voltage for a given package size.

Lower thermal resistance is achieved by joining the four ground leads with the die attach paddle to create a single piece electrical and thermal conductor. This concept has been used by MOSFET manufacturers for years, proving very reliable and cost effective for the user.

Thermal resistance consists of two main elements, θ_{JC} (junction-to-case thermal resistance) and θ_{CA} (case-to-ambient thermal resistance). See Figure 5. θ_{JC} is the resistance from the die to the leads of the package. θ_{CA} is the resistance from the leads to the ambient air and it includes θ_{CS} (case-to-sink thermal resistance) and θ_{SA} (sink-to-ambient thermal resistance).



Figure 5. Thermal Resistance

Using the power MSOP-8 reduces the θ_{JC} dramatically and allows the user to reduce θ_{CA} . The total thermal resistance, θ_{JA} (junction-to-ambient thermal resistance) is the limiting factor in calculating the maximum power dissipation capability of the device. Typically, the power MSOP-8 has a θ_{JC} of 80°C/W, this is significantly lower than the standard MSOP-8 which is typically 200°C/W. θ_{CA} is reduced because pins 5 through 8 can now be soldered directly to a ground plane which significantly reduces the case-to-sink thermal resistance and sink to ambient thermal resistance.

Low-dropout linear regulators from Micrel are rated to a maximum junction temperature of 125°C. It is important not to exceed this maximum junction temperature during operation of the device. To prevent this maximum junction temperature from being exceeded, the appropriate ground plane heatsink must be used.



Figure 6. Copper Area vs. Power-MSOP Power Dissipation (ΔT_{JA})

Figure 6 shows copper area versus power dissipation with each trace corresponding to a different temperature rise above ambient.

From these curves, the minimum area of copper necessary for the part to operate safely can be determined. The maximum allowable temperature rise must be calculated to determine operation along which curve.

$$\Delta T = T_J(\text{max}) - T_A(\text{max})$$

$$T_J(\text{max}) = 125^\circ\text{C}$$

$T_A(\text{max})$ = maximum ambient operating temperature

For example, the maximum ambient temperature is 50°C, the ΔT is determined as follows:

$$\Delta T = 125^\circ\text{C} - 50^\circ\text{C}$$

$$\Delta T = 75^\circ\text{C}$$

Using Figure 6, the minimum amount of required copper can be determined based on the required power dissipation. Power dissipation in a linear regulator is calculated as follows:

$$P_D = (V_{IN} - V_{OUT}) I_{OUT} + V_{IN} \times I_{GND}$$

If we use a 3V output device and a 28V input at moderate output current of 25mA, then our power dissipation is as follows:

$$P_D = (28\text{V} - 3\text{V}) \times 25\text{mA} + 28\text{V} \times 250\mu\text{A}$$

$$P_D = 625\text{mW} + 7\text{mW}$$

$$P_D = 632\text{mW}$$

From Figure 6, the minimum amount of copper required to operate this application at a ΔT of 75°C is 110mm².

Quick Method

Determine the power dissipation requirements for the design along with the maximum ambient temperature at which the device will be operated. Refer to Figure 7, which shows safe operating curves for three different ambient temperatures: 25°C, 50°C and 85°C. From these curves, the minimum amount of copper can be determined by knowing the maximum power dissipation required. If the maximum ambient temperature is 50°C and the power dissipation is as above, 639mW, the curve in Figure 7 shows that the required area of copper is 110mm².

The θ_{JA} of this package is ideally 80°C/W, but it will vary depending upon the availability of copper ground plane to which it is attached.

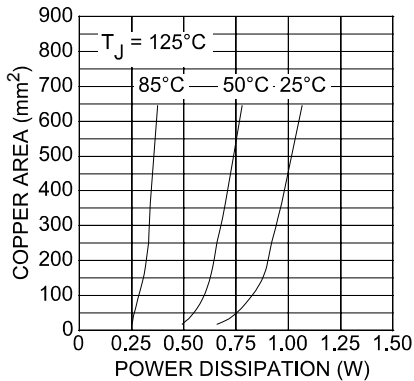

Figure 7. Copper Area vs. Power-MSOP Power Dissipation (T_A)

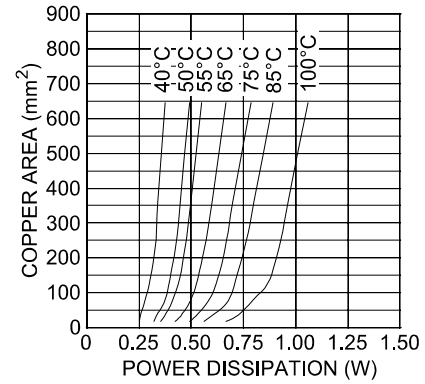

Figure 8. Copper Area vs. Power-SOIC Power Dissipation (ΔT_{JA})

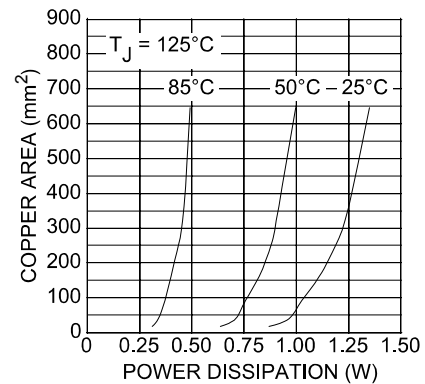

Figure 9. Copper Area vs. Power-SOIC Power Dissipation (T_A)

The same method of determining the heatsink area used for the power MSOP-8 can be applied directly to the power SOIC-8. The same two curves showing power dissipation versus copper area are reproduced for the power SOIC-8 and they can be applied identically.

Power SOIC-8 Thermal Characteristics

The power SOIC-8 package follows the same idea as the power MSOP-8 package, using four ground leads with the die attach paddle to create a single-piece electrical and thermal conductor, reducing thermal resistance and increasing power dissipation capability.

Quick Method

Determine the power dissipation requirements for the design along with the maximum ambient temperature at which the device will be operated. Refer to Figure 9, which shows safe operating curves for three different ambient temperatures, 25°C, 50°C, and 85°C. From these curves, the minimum amount of copper can be determined by knowing the maximum power dissipation required. If the maximum ambient temperature is 50°C, and the power dissipation is 632mW, the curve in Figure 9 shows that the required area of copper is less than 100mm², when using the power SOIC-8.

Adjustable Regulator Application**Figure 10. Adjustable Voltage Application**

The MIC5239YM can be adjusted from 1.24V to 20V by using two external resistors (Figure 10). The resistors set the output voltage based on the following equation:

$$V_{OUT} = V_{REF} \left(1 + \frac{R1}{R2} \right)$$

Where $V_{REF} = 1.23V$.

Feedback resistor $R2$ should be no larger than 300k Ω .

Package Information

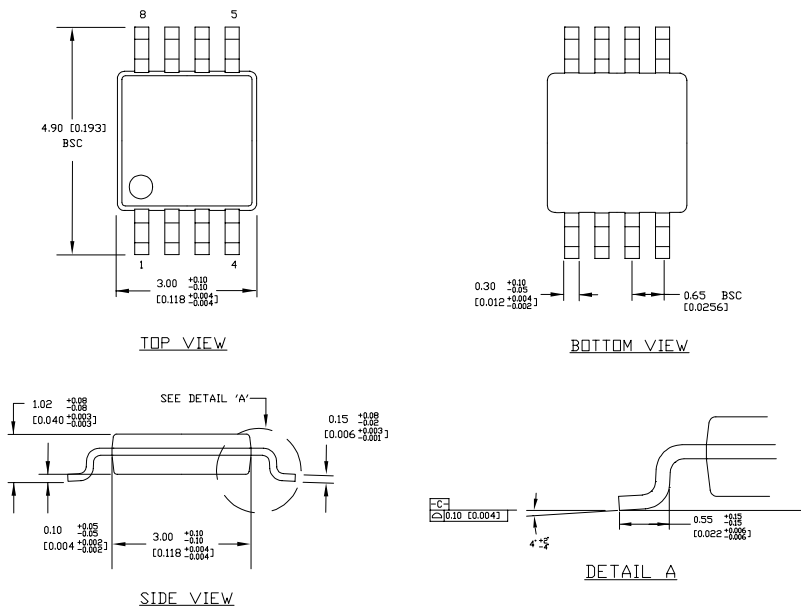

- NOTES:
 1. DIMENSIONS ARE IN MM [INCHES].
 2. CONTROLLING DIMENSION: MM
 3. DIMENSION DOES NOT INCLUDE MOLD FLASH OR PROTRUSIONS, EITHER OF WHICH SHALL NOT EXCEED 0.20 [0.008] PER SIDE.

8-Pin MSOP (MM)



- NOTE:
 1. Dimensions and tolerances are as per ANSI Y14.5M, 1982.
 2. Controlling dimension: Millimeters.
 3. Dimensions are exclusive of mold flash and gate burr.
 4. All specification comply to Jedec spec TO261 Issue C.

SOT-223 (S)



TOP VIEW

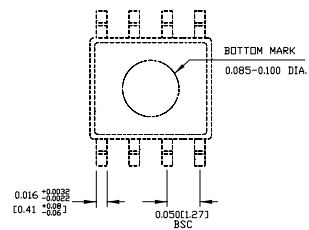

BOTTOM VIEW



END VIEW



DETAIL "A"

- NOTES:
1. DIMENSIONS ARE IN INCHES(MM).
 2. CONTROLLING DIMENSION: INCHES.
- △ DIMENSION DOES NOT INCLUDE MOLD FLASH OR PROTRUSIONS, EITHER OF WHICH SHALL NOT EXCEED 0.010(0.25) PER SIDE.

8-Pin SOIC (M)

MICREL, INC. 2180 FORTUNE DRIVE SAN JOSE, CA 95131 USA
 TEL +1 (408) 944-0800 FAX +1 (408) 474-1000 WEB <http://www.micrel.com>

The information furnished by Micrel in this data sheet is believed to be accurate and reliable. However, no responsibility is assumed by Micrel for its use. Micrel reserves the right to change circuitry and specifications at any time without notification to the customer.

Micrel Products are not designed or authorized for use as components in life support appliances, devices or systems where malfunction of a product can reasonably be expected to result in personal injury. Life support devices or systems are devices or systems that (a) are intended for surgical implant into the body or (b) support or sustain life, and whose failure to perform can be reasonably expected to result in a significant injury to the user. A Purchaser's use or sale of Micrel Products for use in life support appliances, devices or systems is a Purchaser's own risk and Purchaser agrees to fully indemnify Micrel for any damages resulting from such use or sale.

© 2003 Micrel, Incorporated.

Looking for pricing, stock, or lifecycle information?

Click below to explore more details on WIN SOURCE:

- ⊖ [View MIC5239-1.8YMM on WIN SOURCE](#)
- ⊖ [Microchip Technology](#) Information

Optimize Your Supply Chain with WIN SOURCE Solutions

- ✓ Global Sourcing Solution
- ✓ Obsolete Management
- ✓ Cost Control Management
- ✓ Shortage Management
- ✓ Alternative Solution
- ✓ Excess Inventory Management