



**THE DATASHEET OF  
IRF7755TRPBF**



# IRF7755PbF

HEXFET® Power MOSFET

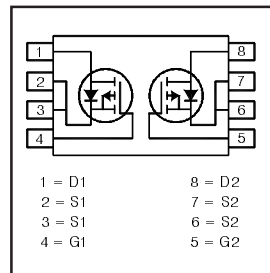
- Ultra Low On-Resistance
- Dual P-Channel MOSFET
- Very Small SOIC Package
- Low Profile (< 1.2mm)
- Available in Tape & Reel
- Lead-Free

| $V_{DS}$ | $R_{DS(on)}$ max        | $I_D$ |
|----------|-------------------------|-------|
| -20V     | 51mΩ @ $V_{GS} = -4.5V$ | -3.7A |
|          | 86mΩ @ $V_{GS} = -2.5V$ | -2.8A |

## Description

HEXFET® Power MOSFETs from International Rectifier utilize advanced processing techniques to achieve extremely low on-resistance per silicon area. This benefit, combined with the ruggedized device design, that International Rectifier is well known for, provides the designer with an extremely efficient and reliable device for battery and load management.

The TSSOP-8 package has 45% less footprint area than the standard SO-8. This makes the TSSOP-8 an ideal device for applications where printed circuit board space is at a premium. The low profile (<1.2mm) allows it to fit easily into extremely thin environments such as portable electronics and PCMCIA cards.



## Absolute Maximum Ratings

|                            | Parameter                                  | Max.        | Units |
|----------------------------|--|-------------|-------|
| $V_{DS}$                   | Drain-Source Voltage                       | -20         | V     |
| $I_D$ @ $T_A = 25^\circ C$ | Continuous Drain Current, $V_{GS}$ @ -4.5V | -3.9        | A     |
| $I_D$ @ $T_A = 70^\circ C$ | Continuous Drain Current, $V_{GS}$ @ -4.5V | -3.1        |       |
| $I_{DM}$                   | Pulsed Drain Current <sup>①</sup>          | -15         |       |
| $P_D$ @ $T_A = 25^\circ C$ | Maximum Power Dissipation <sup>③</sup>     | 1           | W     |
| $P_D$ @ $T_A = 70^\circ C$ | Maximum Power Dissipation <sup>③</sup>     | 0.64        | W     |
|                            | Linear Derating Factor                     | 0.01        | W/°C  |
| $V_{GS}$                   | Gate-to-Source Voltage                     | ±20         | V     |
| $T_J, T_{STG}$             | Junction and Storage Temperature Range     | -55 to +150 | °C    |

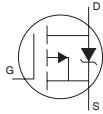
## Thermal Resistance

|                 | Parameter                                | Max. | Units |
|-----------------|--|------|-------|
| $R_{\theta JA}$ | Maximum Junction-to-Ambient <sup>③</sup> | 125  | °C/W  |

## Electrical Characteristics @ $T_J = 25^\circ\text{C}$ (unless otherwise specified)

|                                 | Parameter                            | Min.  | Typ.  | Max. | Units | Conditions   |
|---------------------------------|--------------------------------------|-------|-------|------|-------|--|
| $V_{(BR)DSS}$                   | Drain-to-Source Breakdown Voltage    | -20   | —     | —    | V     | $V_{GS} = 0V, I_D = -250\mu A$                       |
| $\Delta V_{(BR)DSS}/\Delta T_J$ | Breakdown Voltage Temp. Coefficient  | —     | 0.011 | —    | V/°C  | Reference to $25^\circ\text{C}, I_D = -1\text{mA}$   |
| $R_{DS(on)}$                    | Static Drain-to-Source On-Resistance | —     | 35.3  | 51   | mΩ    | $V_{GS} = -4.5V, I_D = -3.7A$ ②                      |
|                                 |                                      | —     | 44.3  | 86   |       | $V_{GS} = -2.5V, I_D = -2.8A$ ②                      |
| $V_{GS(th)}$                    | Gate Threshold Voltage               | -0.45 | —     | -1.2 | V     | $V_{DS} = V_{GS}, I_D = -250\mu A$                   |
| $g_{fs}$                        | Forward Transconductance             | 7.0   | —     | —    | S     | $V_{DS} = -10V, I_D = -3.7A$                         |
| $I_{DSS}$                       | Drain-to-Source Leakage Current      | —     | —     | -15  | μA    | $V_{DS} = -16V, V_{GS} = 0V$                         |
|                                 |                                      | —     | —     | -25  |       | $V_{DS} = -16V, V_{GS} = 0V, T_J = 70^\circ\text{C}$ |
| $I_{GSS}$                       | Gate-to-Source Forward Leakage       | —     | —     | -100 | nA    | $V_{GS} = -12V$                                      |
|                                 | Gate-to-Source Reverse Leakage       | —     | —     | 100  |       | $V_{GS} = 12V$                                       |
| $Q_g$                           | Total Gate Charge                    | —     | 11    | 17   | nC    | $I_D = -3.7A$  |
| $Q_{gs}$                        | Gate-to-Source Charge                | —     | 2.1   | —    |       | $V_{DS} = -16V$                                      |
| $Q_{gd}$                        | Gate-to-Drain ("Miller") Charge      | —     | 3.5   | —    |       | $V_{GS} = -4.5V$                                     |
| $t_{d(on)}$                     | Turn-On Delay Time                   | —     | 9     | 14   | ns    | $V_{DD} = -10V, V_{GS} = -4.5V$                      |
| $t_r$                           | Rise Time                            | —     | 13    | 20   |       | $I_D = -1.0A$  |
| $t_{d(off)}$                    | Turn-Off Delay Time                  | —     | 89    | 133  |       | $R_G = 6.0\Omega$                                    |
| $t_f$                           | Fall Time                            | —     | 61    | 92   |       | $R_D = 10\Omega$ ②                                   |
| $C_{iss}$                       | Input Capacitance                    | —     | 1090  | —    | pF    | $V_{GS} = 0V$  |
| $C_{oss}$                       | Output Capacitance                   | —     | 182   | —    |       | $V_{DS} = -15V$                                      |
| $C_{rss}$                       | Reverse Transfer Capacitance         | —     | 124   | —    |       | $f = 1.0\text{MHz}$                                  |

## Source-Drain Ratings and Characteristics

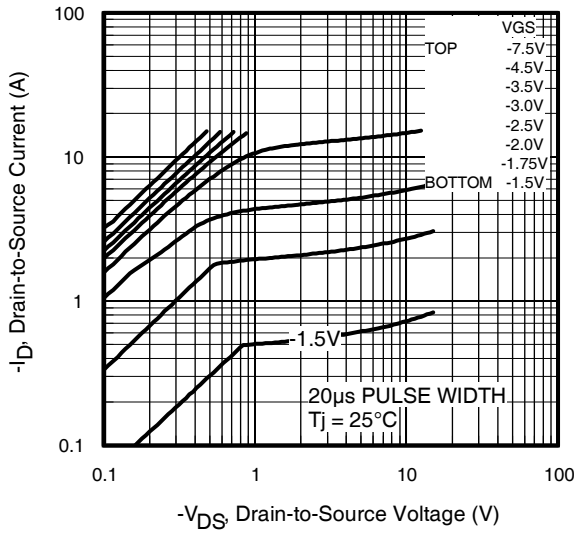
|          | Parameter                                 | Min. | Typ. | Max. | Units | Conditions   |
|----------|---|------|------|------|-------|--|
| $I_S$    | Continuous Source Current<br>(Body Diode) | —    | —    | -1.0 | A     | MOSFET symbol showing the integral reverse p-n junction diode.  |
| $I_{SM}$ | Pulsed Source Current<br>(Body Diode) ①   | —    | —    | -15  |       |  |
| $V_{SD}$ | Diode Forward Voltage                     | —    | —    | -1.2 | V     | $T_J = 25^\circ\text{C}, I_S = -1.0A, V_{GS} = 0V$ ②   |
| $t_{rr}$ | Reverse Recovery Time                     | —    | 55   | 82   | ns    | $T_J = 25^\circ\text{C}, I_F = -1.0A$  |
| $Q_{rr}$ | Reverse Recovery Charge                   | —    | 29   | 43   | nC    | $di/dt = -100A/\mu s$ ②  |

### Notes:

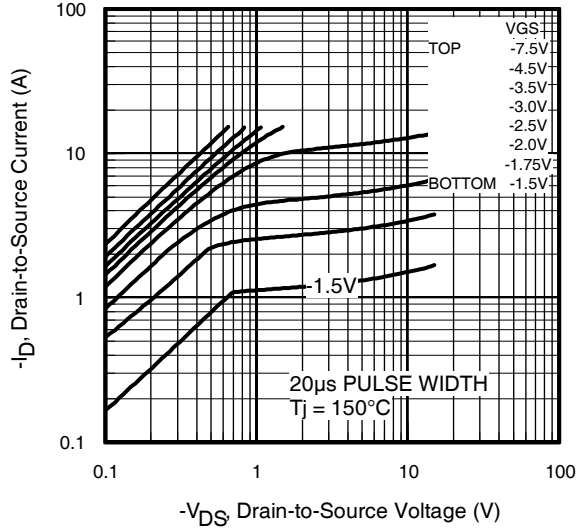
① Repetitive rating; pulse width limited by max. junction temperature.

② Pulse width  $\leq 300\mu s$ ; duty cycle  $\leq 2\%$ .

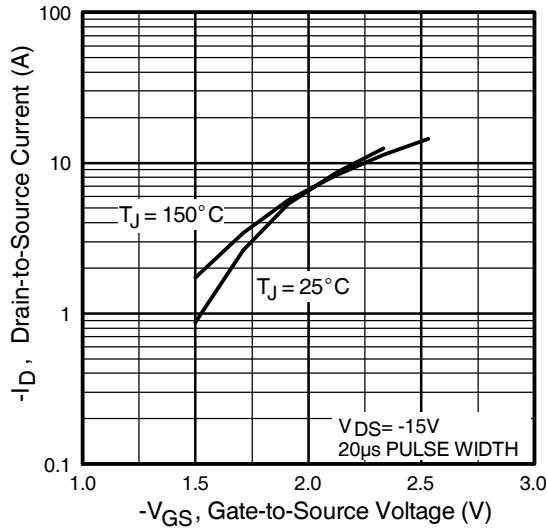
③ When mounted on 1 inch square copper board,  $t < 10\text{sec}$ .



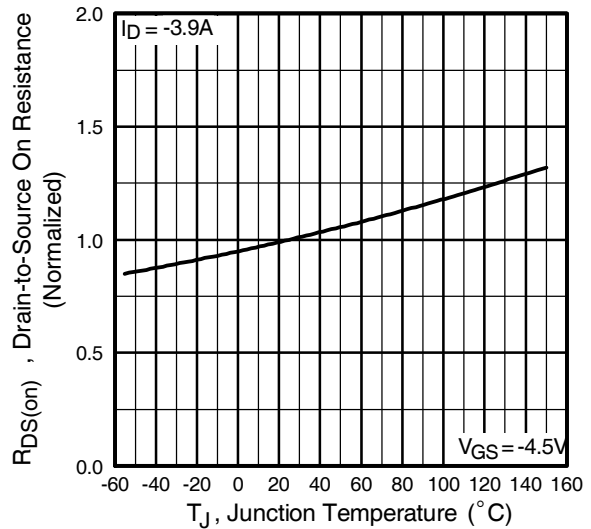
**Fig 1.** Typical Output Characteristics



**Fig 2.** Typical Output Characteristics

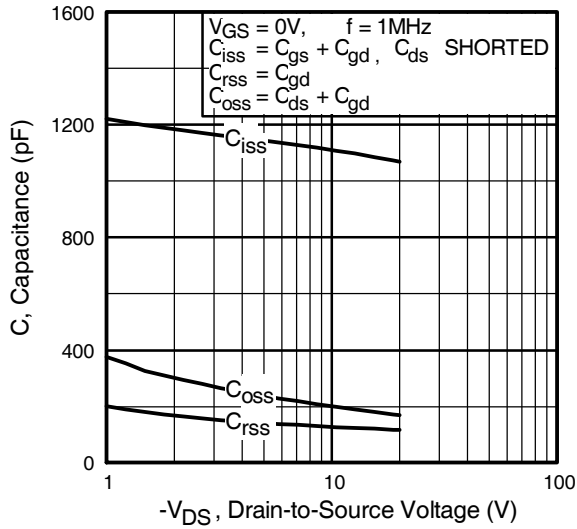


**Fig 3.** Typical Transfer Characteristics

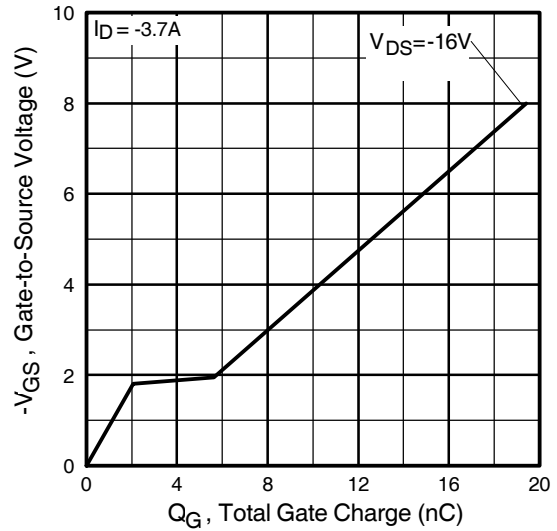


**Fig 4.** Normalized On-Resistance Vs. Temperature

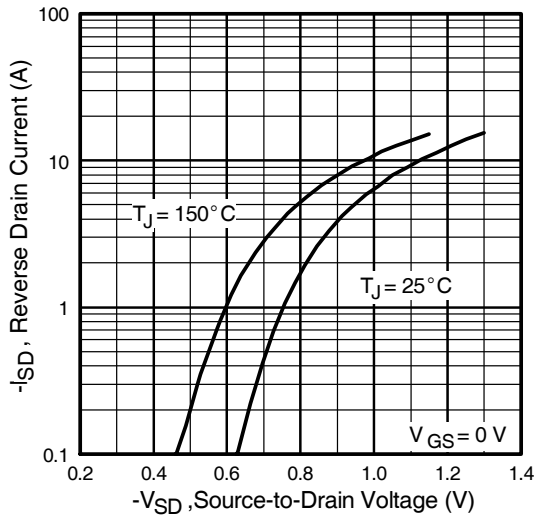
# IRF7755PbF



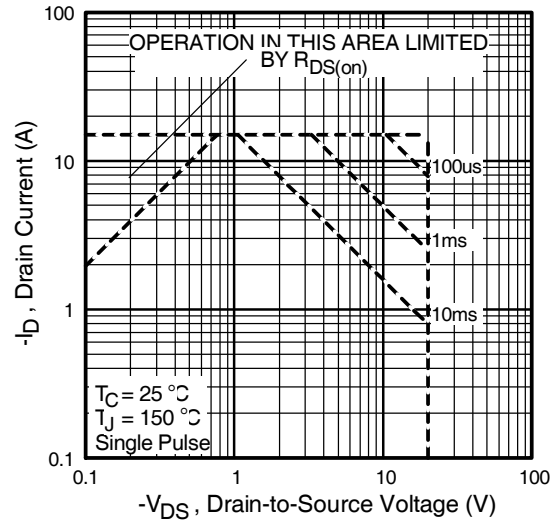
**Fig 5.** Typical Capacitance Vs. Drain-to-Source Voltage



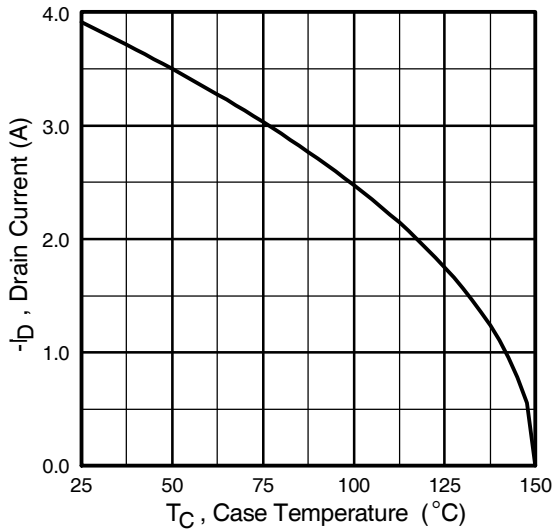
**Fig 6.** Typical Gate Charge Vs. Gate-to-Source Voltage



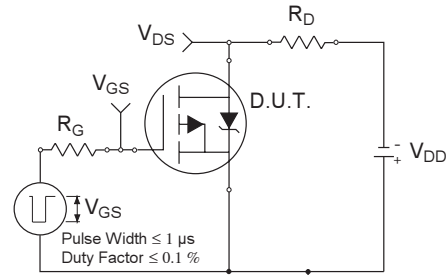
**Fig 7.** Typical Source-Drain Diode Forward Voltage



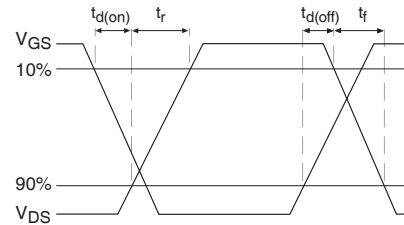
**Fig 8.** Maximum Safe Operating Area



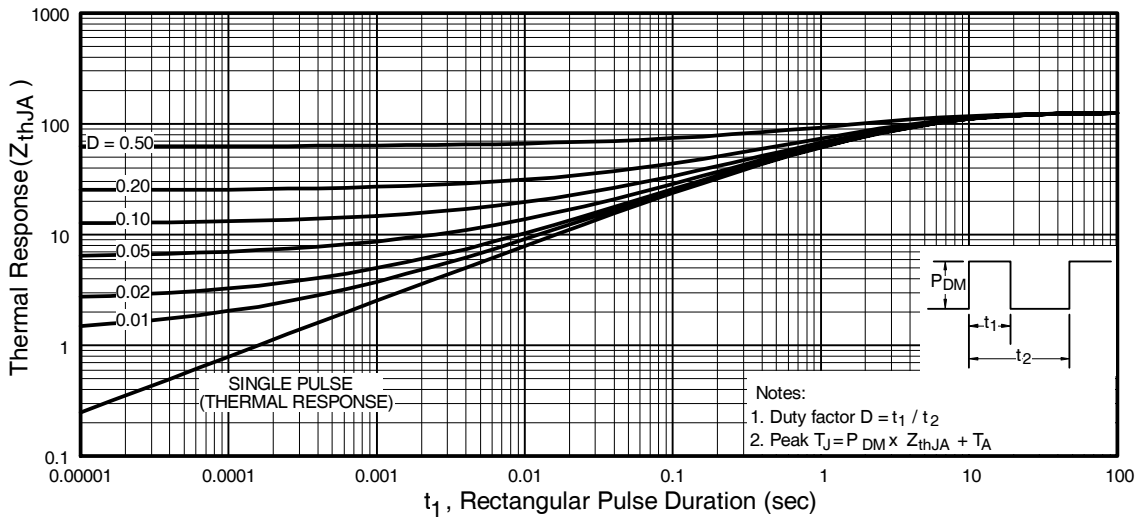
**Fig 9.** Maximum Drain Current Vs. Case Temperature



**Fig 10a.** Switching Time Test Circuit



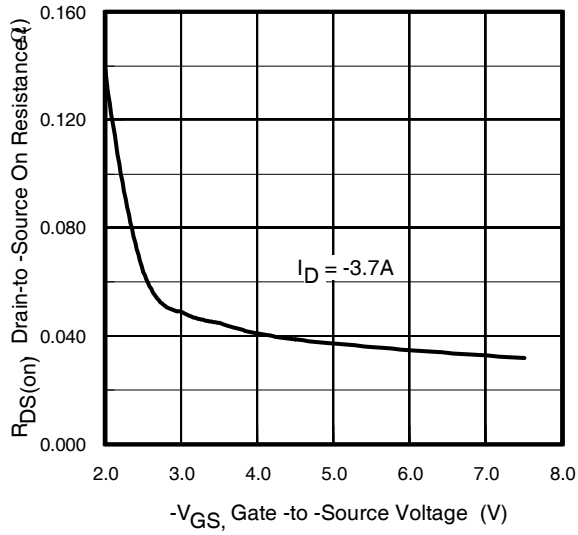
**Fig 10b.** Switching Time Waveforms



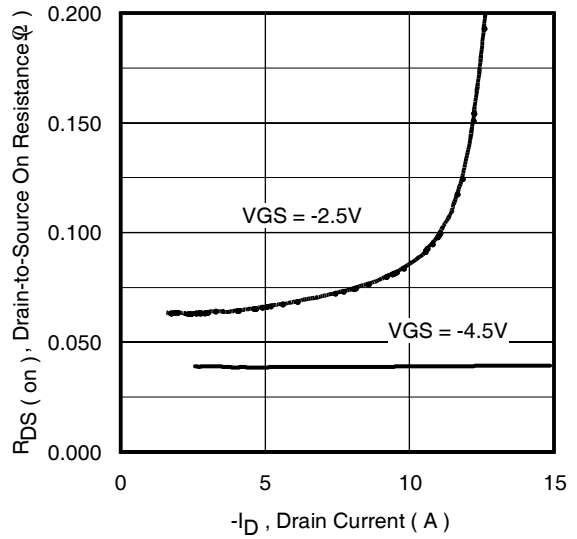
**Fig 11.** Maximum Effective Transient Thermal Impedance, Junction-to-Ambient

# IRF7755PbF

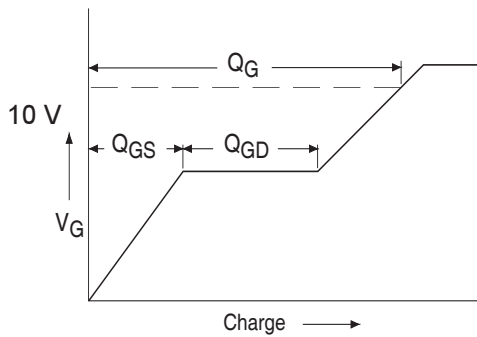
International  
**IR** Rectifier



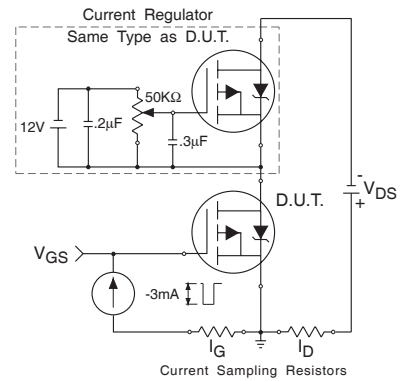
**Fig 12.** Typical On-Resistance Vs. Gate Voltage



**Fig 13.** Typical On-Resistance Vs. Drain Current



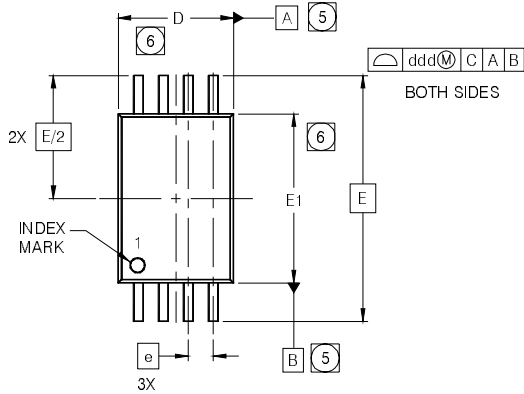
**Fig 14a.** Basic Gate Charge Waveform



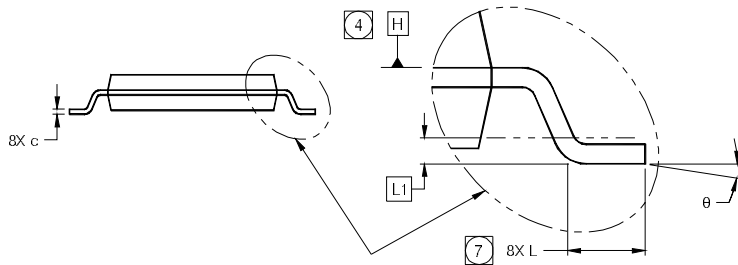
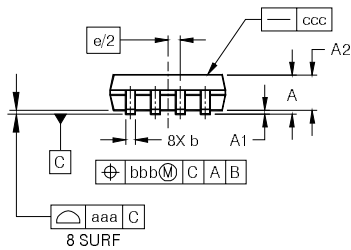
**Fig 14b.** Gate Charge Test Circuit

## TSSOP8 Package Outline

Dimensions are shown in millimeters (inches)



| SYMBOL | MO-153AA DIMENSIONS |      |      |          |       |       |
|--------|---------------------|------|------|----------|-------|-------|
|        | MILLIMETERS         |      |      | INCHES   |       |       |
|        | MIN                 | NOM  | MAX  | MIN      | NOM   | MAX   |
| A      | ---                 | ---  | 1.20 | ---      | ---   | .0472 |
| A1     | 0.05                | ---  | 0.15 | .0020    | ---   | .0059 |
| A2     | 0.80                | 1.00 | 1.05 | .032     | .039  | .041  |
| b      | 0.19                | ---  | 0.30 | .0075    | ---   | .0118 |
| c      | 0.09                | ---  | 0.20 | .0036    | ---   | .0078 |
| D      | 2.90                | 3.00 | 3.10 | .115     | .118  | .122  |
| E      | 6.40 BSC            |      |      | .251 BSC |       |       |
| E1     | 4.30                | 4.40 | 4.50 | .170     | .173  | .177  |
| e      | 0.65 BSC            |      |      | .0256    |       |       |
| L      | 0.45                | 0.60 | 0.75 | .0178    | .0236 | .0290 |
| L1     | 0.25 BSC            |      |      | .010 BSC |       |       |
| θ      | 0°                  | ---  | 8°   | 0°       | ---   | 8°    |
| aaa    | 0.10                |      |      | .0039    |       |       |
| bbb    | 0.10                |      |      | .0039    |       |       |
| ccc    | 0.05                |      |      | .0019    |       |       |
| ddd    | 0.20                |      |      | .0078    |       |       |



### LEAD ASSIGNMENTS



### NOTES

- DIMENSIONING AND TOLERANCING PER ASME Y14.5M-1994.
- DIMENSIONS ARE SHOWN IN MILLIMETERS AND INCHES.
- CONTROLLING DIMENSION: MILLIMETER.
- DATUM PLANE H IS LOCATED AS SHOWN.
- DATUM A AND B TO BE DETERMINED AT DATUM PLANE H.
- DIMENSIONS D AND E1 ARE MEASURED AT DATUM PLANE H.
- DIMENSION L IS THE LEAD LENGTH FOR SOLDERING TO A SUBSTRATE.
- OUTLINE CONFORMS TO JEDEC OUTLINE MO-153AA.

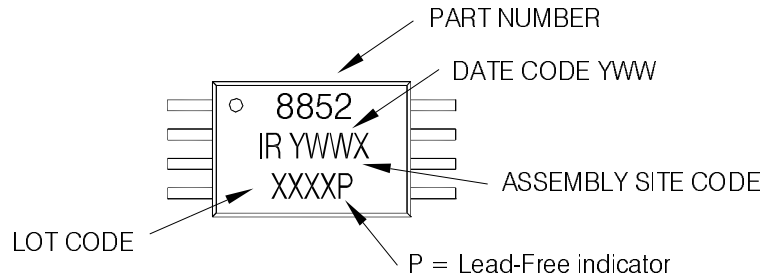
Note: For the most current drawing please refer to IR website at <http://www.irf.com/package/>  
www.irf.com

# IRF7755PbF

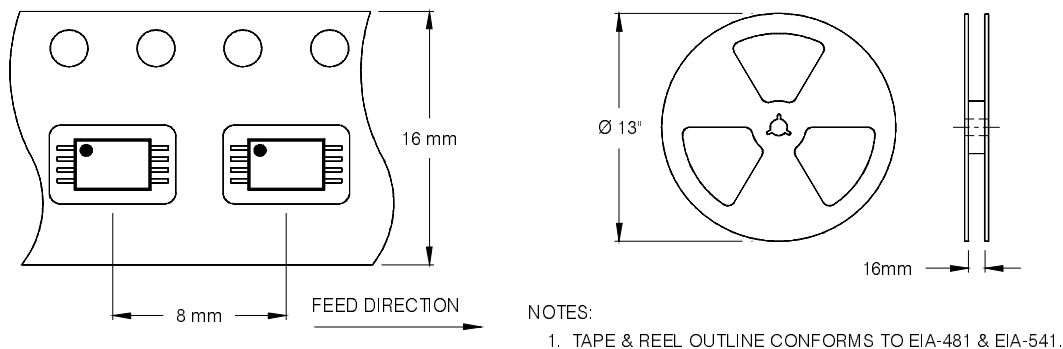
International  
**IR** Rectifier

## TSSOP8 Part Marking Information

EXAMPLE: THIS IS AN IRF8852PBF



## TSSOP-8 Tape and Reel Information



Note: For the most current drawing please refer to IR website at <http://www.irf.com/package/>

Data and specifications subject to change without notice.  
This product has been designed and qualified for the Consumer market.  
Qualification Standards can be found on IR's Web site.

International  
**IR** Rectifier

IR WORLD HEADQUARTERS: 233 Kansas St., El Segundo, California 90245, USA Tel: (310) 252-7105  
TAC Fax: (310) 252-7903

Visit us at [www.irf.com](http://www.irf.com) for sales contact information.05/2009

[www.irf.com](http://www.irf.com)

## Looking for pricing, stock, or lifecycle information?

Click below to explore more details on WIN SOURCE:

 [View IRF7755TRPBF on WIN SOURCE](#)

 [Infineon Technologies](#) Information

## Optimize Your Supply Chain with WIN SOURCE Solutions

-  Global Sourcing Solution
-  Obsolete Management
-  Cost Control Management
-  Shortage Management
-  Alternative Solution
-  Excess Inventory Management