



**THE DATASHEET OF
MAX4482AUA+**



MAX4480–MAX4483

Single/Dual/Quad, Low-Cost, Single-Supply, Rail-to-Rail Op Amps with Shutdown

General Description

The MAX4480–MAX4483 low-cost, general-purpose op amps offer rail-to-rail outputs, draw only 50 μ A of quiescent current, and operate from a single +2.5V to +5.5V supply. For additional power conservation, the MAX4481 offers a low-power shutdown mode that reduces supply current to 0.5 μ A (max) and puts the amplifier's output in a high-impedance state. These devices are unity-gain stable with capacitive loads up to 400pF. The MAX4480–MAX4483 are specified to +125°C, making them suitable for use in a variety of harsh environments.

The MAX4480 is a single amplifier offered in a tiny 5-pin SC70 package. The MAX4481 is a single amplifier with a low-power shutdown mode that reduces supply current to < 0.5 μ A and comes in a 6-pin SC70 package. The MAX4482 is a dual amplifier and comes in the space-saving 8-pin SOT23 or μ MAX® package. The MAX4483 is a quad amplifier and comes in a 14-pin TSSOP package. All devices are specified for operation across the -40°C to +125°C automotive temperature range.

Applications

- Single-Supply Zero-Crossing Detectors
- Instruments and Terminals
- Portable Communications
- Electronic Ignition Modules
- Infrared Receivers
- Sensor Signal Detection

Selector Guide

PART	NO. OF AMPLIFIERS PER PACKAGE	SHUTDOWN MODE
MAX4480	1	No
MAX4481	1	Yes
MAX4482	2	No
MAX4483	4	No

μ MAX is a registered trademark of Maxim Integrated Products, Inc.

Features

- Single +2.5V to +5.5V Supply Voltage Range
- 50 μ A Quiescent Current per Amplifier
- 0.5 μ A (max) Shutdown Mode (MAX4481)
- Available in Space-Saving Packages
 - 5-Pin SC70 (MAX4480)
 - 6-Pin SC70 (MAX4481)
 - 8-Pin SOT23 (MAX4482)
- 105dB AV_{OL} with 5k Ω Load
- 0.005% THD with 100k Ω Load
- Rail-to-Rail Output Voltage Swing
- 3.0mA of Sink and Source Load Current
- Unity-Gain Stable up to $C_{LOAD} = 400$ pF

Ordering Information

PART	TEMP RANGE	PIN-PACKAGE	TOP MARK
MAX4480AXK+T	-40°C to +125°C	5 SC70	ABU
MAX4480AUK+T	-40°C to +125°C	5 SOT23	ADPJ
MAX4481AXT+T	-40°C to +125°C	6 SC70	AAN
MAX4481AUT+T	-40°C to +125°C	6 SOT23	AAOS
MAX4481MXT/PR3+	-55°C to +110°C	6 SC70	AEE
MAX4482AKA+T	-40°C to +125°C	8 SOT23	AAEJ
MAX4482ASA+	-40°C to +125°C	8 SO	—
MAX4482AUA+	-40°C to +125°C	8 FMAX	—
MAX4483ASD+	-40°C to +125°C	14 SO	—
MAX4483AUD+	-40°C to +125°C	14 TSSOP	—

+Denotes a lead(Pb)-free/RoHS-compliant package.
T = Tape and reel.

Pin Configurations

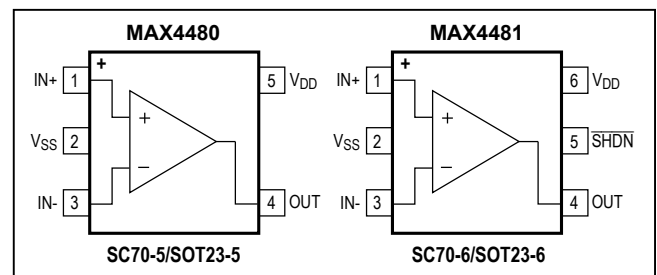

Pin Configurations continued at end of data sheet.

Absolute Maximum Ratings

Power-Supply Voltage (V_{DD} to V_{SS}).....	-0.3V to +6V	8-Pin μ MAX (derate 4.5mW/°C above +70°C).....	362mW
All Other Pins.....($V_{SS} - 0.3V$) to ($V_{DD} + 0.3V$)		8-Pin SO (derate 5.9mW/°C above +70°C).....	471mW
Output Short-Circuit Duration		14-Pin TSSOP (derate 9.1mW/°C above +70°C).....	727mW
(OUT shorted to V_{SS} or V_{DD}).....	Continuous	14-Pin SO (derate 8.33mW/°C above +70°C).....	667mW
Continuous Power Dissipation ($T_A = +70^\circ\text{C}$)		Operating Temperature Range	-40°C to +125°C
5-Pin SC70 (derate 3.1mW/°C above +70°C).....	247mW	Military Operating Temperature Range.....	-55°C to +110°C
6-Pin SC70 (derate 3.1mW/°C above +70°C).....	245mW	Junction Temperature.....	150°C
5-Pin SOT23 (derate 3.1mW/°C above +70°C).....	247mW	Storage Temperature Range.....	-65°C to +150°C
6-Pin SOT23 (derate 8.7mW/°C above +70°C).....	696mW	Lead Temperature (soldering, 10s).....	+3000°C
8-Pin SOT23 (derate 5.1mW/°C above +70°C).....	408mW	Soldering Temperature (reflow).....	+240°C

Stresses beyond those listed under "Absolute Maximum Ratings" may cause permanent damage to the device. These are stress ratings only, and functional operation of the device at these or any other conditions beyond those indicated in the operational sections of the specifications is not implied. Exposure to absolute maximum rating conditions for extended periods may affect device reliability.

Electrical Characteristics

($V_{DD} = +5V$, $V_{SS} = 0V$, $V_{CM} = 0V$, $V_{OUT} = V_{DD}/2$, $R_L \geq 1M\Omega$ connected to $V_{DD}/2$, $\overline{SHDN} = V_{DD}$ (MAX4481 only), $T_A = +25^\circ\text{C}$, unless otherwise noted.)

PARAMETER	SYMBOL	CONDITIONS	MIN	TYP	MAX	UNITS
Supply Voltage Range	V_{DD}	Inferred from PSRR test	2.5		5.5	V
Supply Current per Amplifier	I_{DD}	$V_{DD} = 2.5V$		45		μA
		$V_{DD} = 5.0V$		50	100	
Supply Current in Shutdown	I_{SHDN}	$\overline{SHDN} = V_{SS}$ (MAX4481 only)		0.05	0.5	μA
Input Offset Voltage	V_{OS}			± 1	± 5.5	mV
Input Bias Current	I_B	(Note 1)		± 0.1	± 100	pA
Input Offset Current	I_{OS}	(Note 1)		± 0.1	± 100	pA
Input Resistance	R_{IN}	Differential or common mode		1000		M Ω
Input Common-Mode Voltage Range	V_{CM}	Inferred from CMRR test	V_{SS}		$V_{DD} - 1.3$	V
Common-Mode Rejection Ratio	CMRR	$V_{SS} \leq V_{CM} \leq V_{DD} - 1.3V$	71	86		dB
Power-Supply Rejection Ratio	PSRR	$2.5V \leq V_{DD} \leq 5.5V$	82	92		dB
Large-Signal Voltage Gain	A_{VOL}	$V_{SS} + 0.02V \leq V_{OUT} \leq V_{DD} - 0.03V$ $R_L = 100k\Omega$		110		dB
		$V_{SS} + 0.10V \leq V_{OUT} \leq V_{DD} - 0.20V$ $R_L = 5k\Omega$	94	105		
Output Voltage High	V_{OH}	Specified as $V_{DD} - V_{OUT}$	$R_L = 100k\Omega$	4		mV
			$R_L = 5k\Omega$	80	150	
Output Voltage Low	V_{OL}	Specified as $V_{OUT} - V_{SS}$	$R_L = 100k\Omega$	1		mV
			$R_L = 5k\Omega$	8	30	
Output Short-Circuit Current	I_{SC}	Sourcing		3		mA
		Sinking		17		
Shutdown Mode Output Leakage	$I_{OUTSHDN}$	Device in shutdown mode, $\overline{SHDN} = V_{SS}$, $V_{SS} < V_{OUT} < V_{CC}$ (MAX4481 only)		± 0.01	± 0.1	μA
\overline{SHDN} Logic Low	V_{IL}	MAX4481 only			$0.3 \times V_{DD}$	V
\overline{SHDN} Logic High	V_{IH}	MAX4481 only	$0.7 \times V_{DD}$			V
\overline{SHDN} Input Current	I_{IL}, I_{IH}	$\overline{SHDN} = V_{DD}$ or V_{SS} (MAX4481 only)	± 0.001	± 1	± 500	nA
Gain-Bandwidth Product	GBW			140		kHz

Electrical Characteristics (continued)

($V_{DD} = +5V$, $V_{SS} = 0V$, $V_{CM} = 0V$, $V_{OUT} = V_{DD}/2$, $R_L \geq 1M\Omega$ connected to $V_{DD}/2$, $\overline{SHDN} = V_{DD}$ (MAX4481 only), $T_A = +25^\circ C$, unless otherwise noted.)

PARAMETER	SYMBOL	CONDITIONS		MIN	TYP	MAX	UNITS
Phase Margin	ϕ_M				70		degrees
Gain Margin					30		dB
Slew Rate	SR				80		V/ms
Input Voltage Noise Density	e_n	$f = 10kHz$			100		nV/ \sqrt{Hz}
Input Current Noise Density	i_n	$f = 10kHz$			1		nV/ \sqrt{Hz}
Capacitive-Load Stability	C_{LOAD}	$A_V = +1V/V$			400		pF
Shutdown Delay Time	t_{SHDN}	MAX4481 only			0.4		μs
Enable Delay Time	t_{EN}	MAX4481 only			12		μs
Power-On Time	t_{ON}				15		μs
Input Capacitance	C_{IN}				2.0		pF
Total Harmonic Distortion	THD	$f = 1kHz$, $V_{OUT} = 2V_{P-P}$, $A_V = +1V/V$	$R_L = 100k\Omega$		0.005		%
Settling Time to 0.1%	t_S	$V_{OUT} = 2V$ step			50		μs

Electrical Characteristics

($V_{DD} = +5V$, $V_{SS} = 0V$, $V_{CM} = 0V$, $V_{OUT} = V_{DD}/2$, $R_L \geq 1M\Omega$ connected to $V_{DD}/2$, $\overline{SHDN} = V_{DD}$ (MAX4481 only), $T_A = -40^\circ C$ to $+125^\circ C$, unless otherwise noted.)

PARAMETER	SYMBOL	CONDITIONS		MIN	TYP	MAX	UNITS
Supply Voltage Range	V_{DD}	Inferred from PSRR test		2.5		5.5	V
Supply Current per Amplifier	I_{DD}					120	μA
Supply Current in Shutdown	I_{SHDN}	$\overline{SHDN} = V_{SS}$ (MAX4481 only)				1.0	μA
Input Offset Voltage	V_{OS}					9	mV
Input Offset Voltage Drift	TCV_{OS}				± 3		$\mu V/^\circ C$
Input Bias Current	I_B	(Note 1)				± 100	pA
Input Offset Current	I_{OS}	(Note 1)				± 100	pA
Input Common-Mode Voltage Range	V_{CM}	Inferred from CMRR test		V_{SS}		$V_{DD} - 1.4$	V
Common-Mode Rejection Ratio	CMRR	$V_{SS} \leq V_{CM} \leq V_{DD} - 1.4V$		67			dB
Power-Supply Rejection Ratio	PSRR	$2.5V \leq V_{DD} \leq 5.5V$		77			dB
Shutdown Mode Output Leakage	$I_{OUTSHDN}$	Device in shutdown mode, $\overline{SHDN} = V_{SS}$, $V_{SS} < V_{OUT} < V_{CC}$ (MAX4481 only)	$-40^\circ C$ to $+85^\circ C$			± 0.5	μA
			$+85^\circ C$ to $+125^\circ C$			± 2.5	
\overline{SHDN} Logic Low	V_{IL}	MAX4481 only				$0.3 \times V_{DD}$	V
\overline{SHDN} Logic High	V_{IH}	MAX4481 only		$0.7 \times V_{DD}$			V
\overline{SHDN} Input Current	I_{IL} , I_{IH}	$\overline{SHDN} = V_{DD}$ or V_{SS} (MAX4481 only)				1	μA
Large-Signal Voltage Gain	A_{VOL}	$V_{SS} + 0.1V \leq V_{OUT} \leq V_{DD} - 0.20V$, $R_L = 5k\Omega$		84			dB
Output Voltage High	V_{OH}	Specified as $V_{DD} - V_{OUT}$, $R_L = 5k\Omega$				200	mV
Output Voltage Low	V_{OL}	Specified as $V_{OUT} - V_{SS}$, $R_L = 5k\Omega$				50	mV

Note 1: Guaranteed by design.

Note 2: Specifications are 100% tested at $T_A = +25^\circ C$ (exceptions noted). All temperature limits are guaranteed by design.

Typical Operating Characteristics

($V_{DD} = +5V$, $V_{SS} = 0V$, $V_{CM} = V_{DD}/2$, $V_{SHDN} = 5V$, $R_L \geq 1M\Omega$ connected to $V_{DD}/2$, $T_A = +25^\circ C$, unless otherwise noted.)

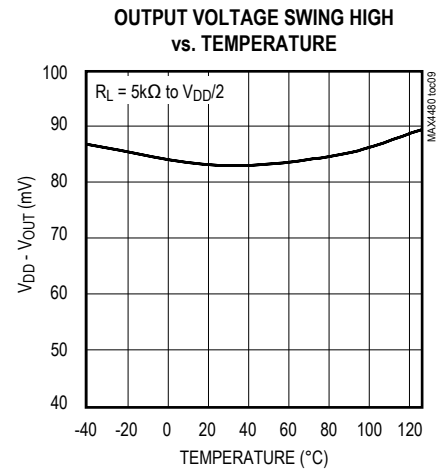
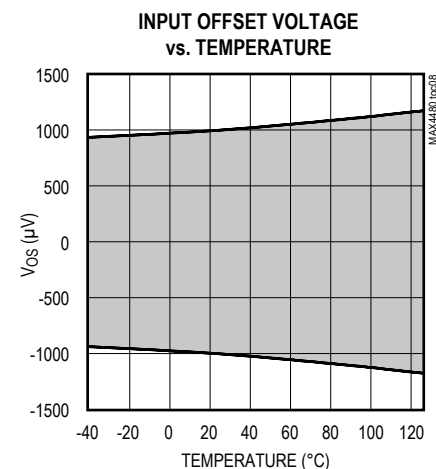
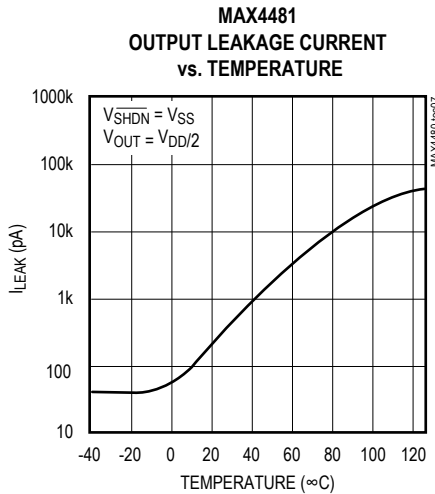
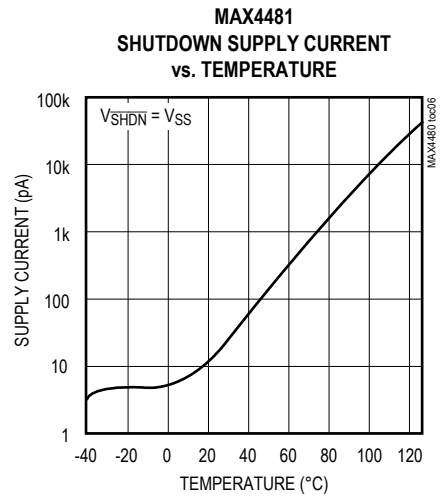
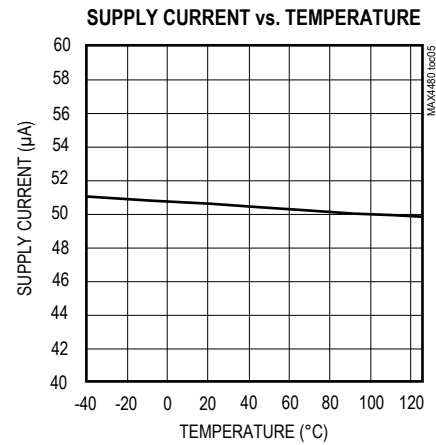
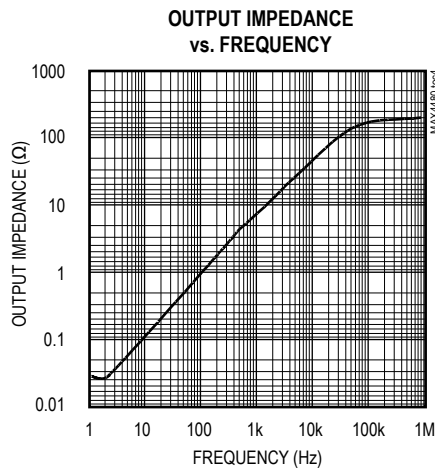
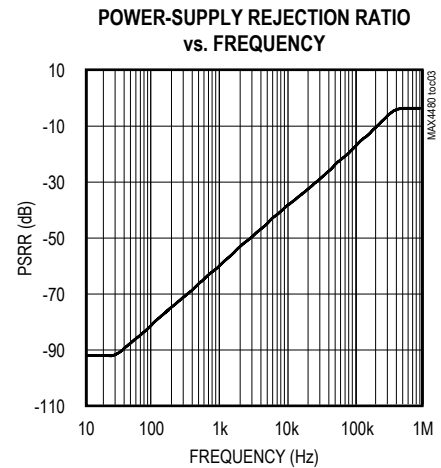
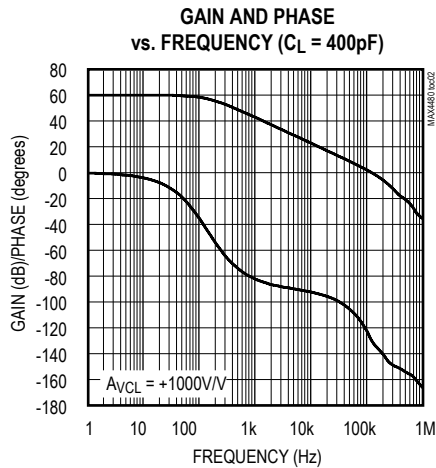
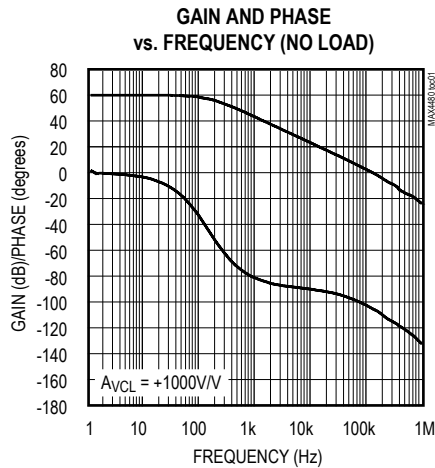

Typical Operating Characteristics (continued)

($V_{DD} = +5V$, $V_{SS} = 0V$, $V_{CM} = V_{DD}/2$, $V_{SHDN} = 5V$, $R_L \geq 1M\Omega$ connected to $V_{DD}/2$, $T_A = +25^\circ C$, unless otherwise noted.)

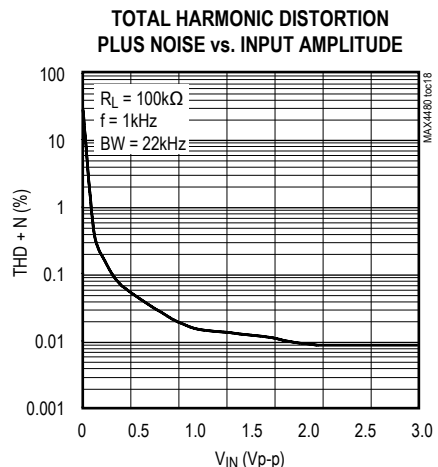
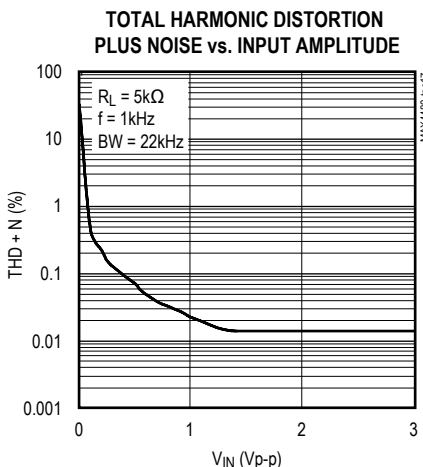
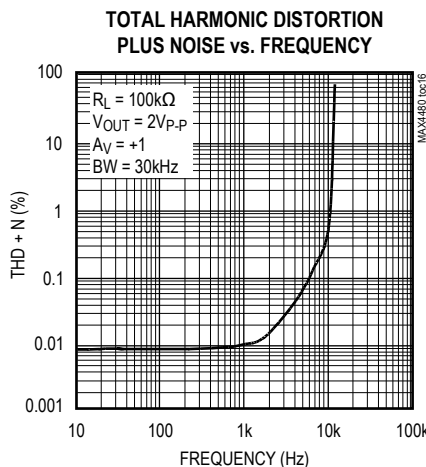
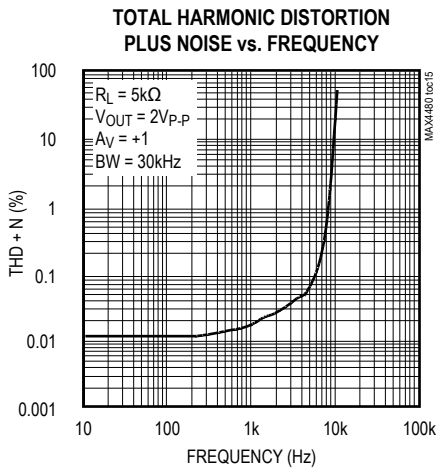
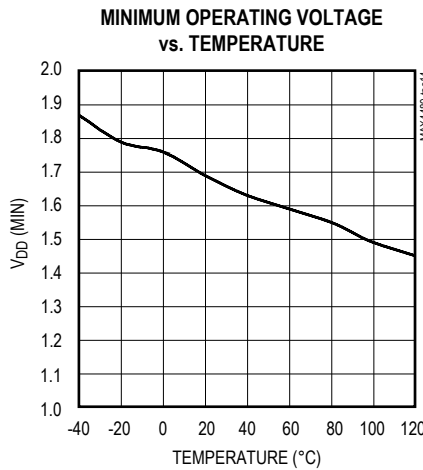
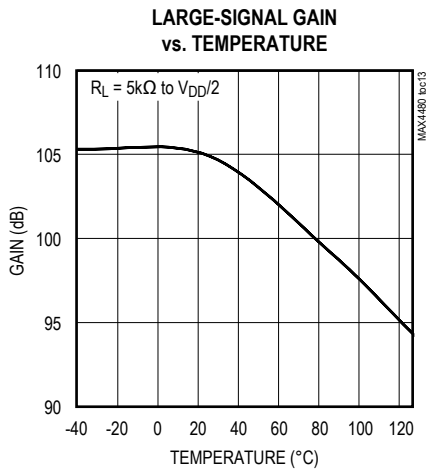
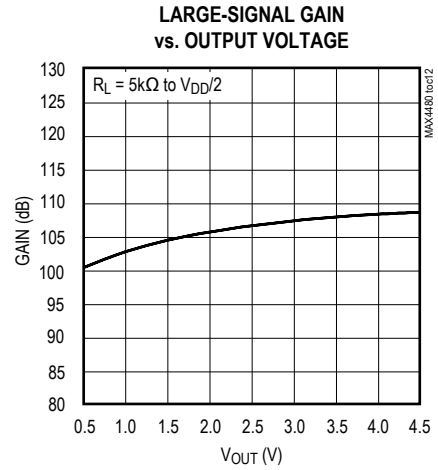
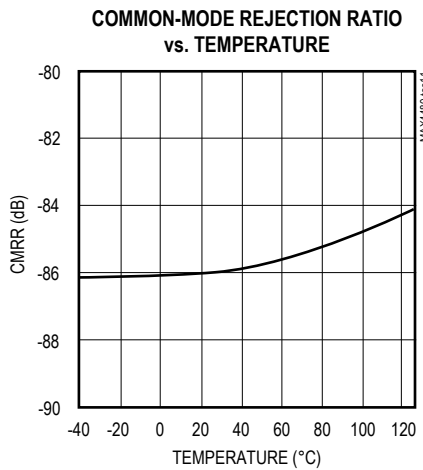
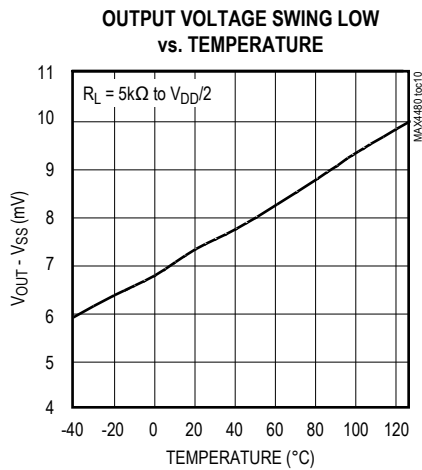

Typical Operating Characteristics (continued)

($V_{DD} = +5V$, $V_{SS} = 0V$, $V_{CM} = V_{DD}/2$, $V_{SHDN} = 5V$, $R_L \geq 1M\Omega$ connected to $V_{DD}/2$, $T_A = +25^\circ C$, unless otherwise noted.)

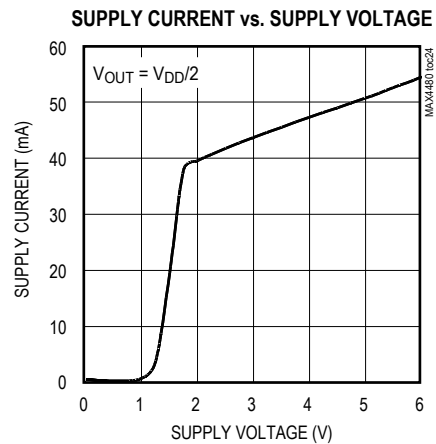
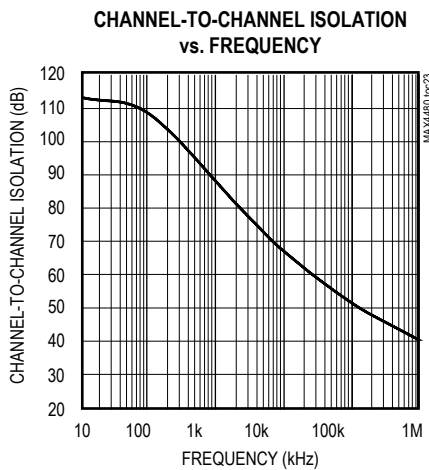
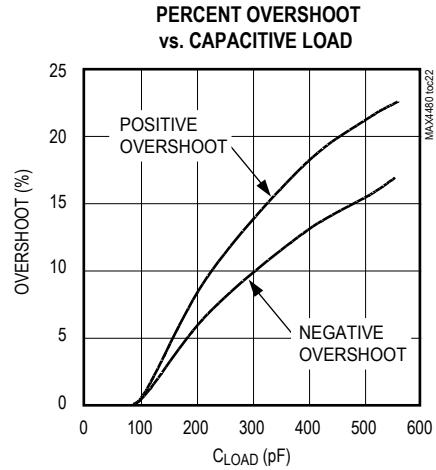
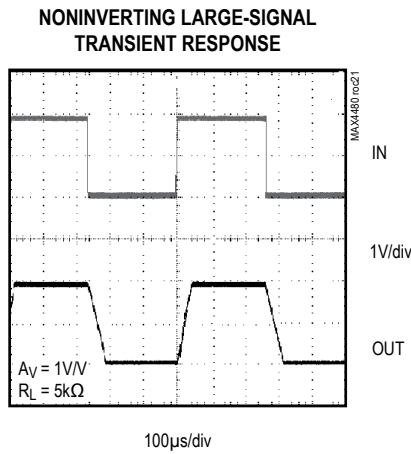
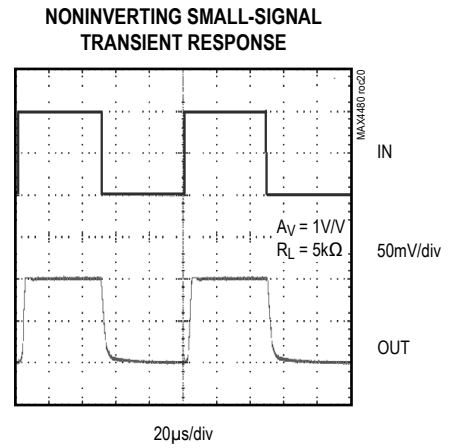
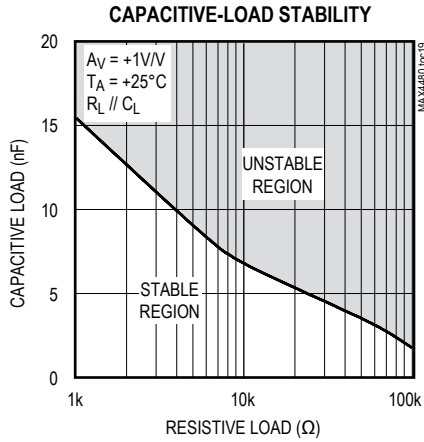

Pin Description

PIN				NAME	FUNCTION
MAX4480	MAX4481	MAX4482	MAX4483		
1	1	—	—	IN+	Noninverting Amplifier Input
—	—	3	3	INA+	Noninverting Amplifier Input A
—	—	5	5	INB+	Noninverting Amplifier Input B
—	—	—	10	INC+	Noninverting Amplifier Input C
—	—	—	12	IND+	Noninverting Amplifier Input D
2	2	4	11	V _{SS}	Negative Supply. Connect to ground for single-supply operation. Use a 0.01μF bypass capacitor to GND.
3	3	—	—	IN-	Inverting Amplifier Input
—	—	2	2	INA-	Inverting Amplifier Input A
—	—	6	6	INB-	Inverting Amplifier Input B
—	—	—	9	INC-	Inverting Amplifier Input C
—	—	—	13	IND-	Inverting Amplifier Input D
4	4	—	—	OUT	Amplifier Output
—	—	1	1	OUTA	Amplifier Output A
—	—	7	7	OUTB	Amplifier Output B
—	—	—	8	OUTC	Amplifier Output C
—	—	—	14	OUTD	Amplifier Output D
5	6	8	4	V _{DD}	Positive Supply. Use a 0.01μF bypass capacitor to GND.
—	5	—	—	$\overline{\text{SHDN}}$	Active-Low Shutdown Input. Connect to V _{DD} for normal operation. Do not leave floating.

Detailed Description

Rail-to-Rail Output Stage

The MAX4480–MAX4483 can drive a 5kΩ load and still typically swing within 80mV of the supply rails. Figure 1 shows the MAX4480 output voltage swing configured with A_V = +10V/V.

Driving Capacitive Loads

Driving a capacitive load can cause instability in many op amps, especially those with low quiescent current. The MAX4480–MAX4483 are unity-gain stable for a range of capacitive loads to above 400pF. Figure 2 shows the MAX4480 response with an excessive capacitive load. Adding a series resistor between the output and the load capacitor (Figure 3) improves the circuit’s response by isolating the load capacitance from the op amp’s output.

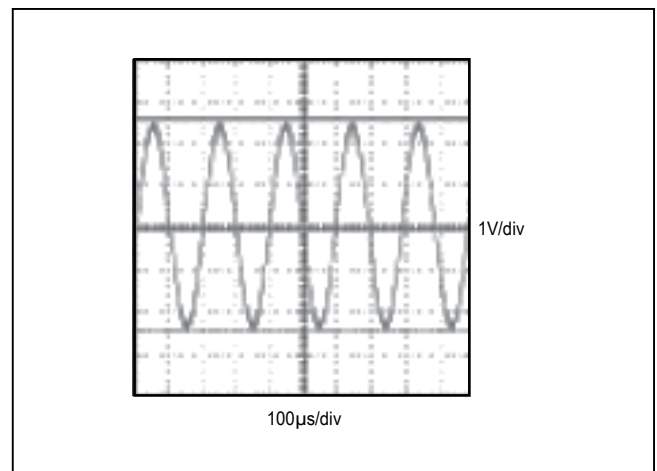

Figure 1. Rail-to-Rail Output Operation

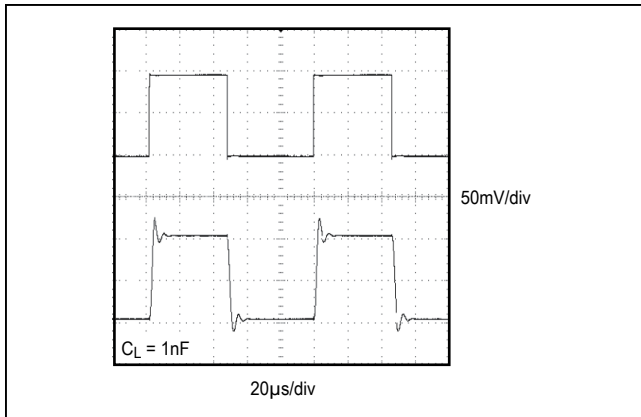

Figure 2. Small-Signal Transient Response with Excessive Capacitive Load

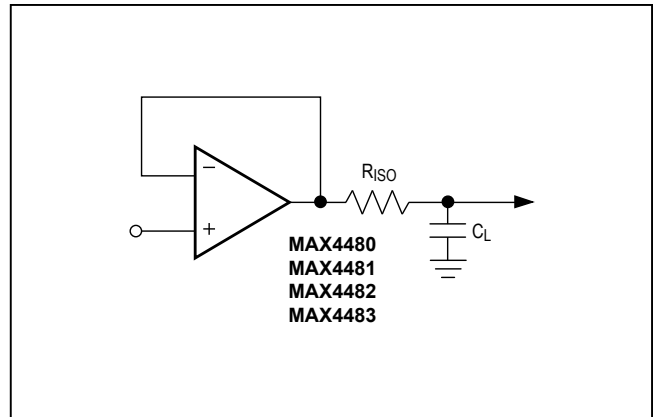

Figure 3. Capacitive-Load-Driving Circuit

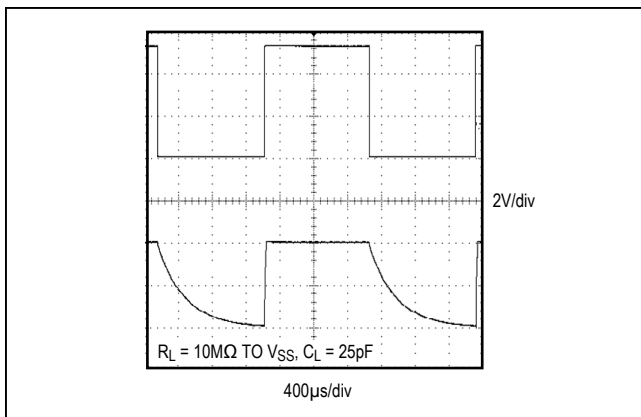

Figure 4. Shutdown Waveform

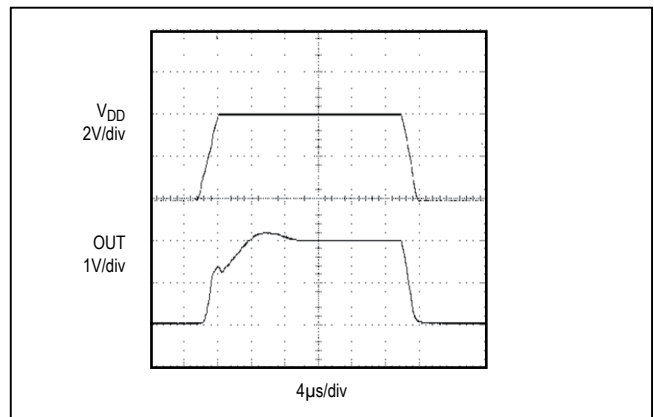

Figure 5. Power-Up/Down Waveform

Applications Information

Shutdown Mode

The MAX4481 features a low-power shutdown mode. When $\overline{\text{SHDN}}$ goes low, the supply current drops to 0.05µA (typ) and the output enters a high-impedance state. Pull $\overline{\text{SHDN}}$ high to enable the amplifier. Do not leave $\overline{\text{SHDN}}$ floating. Figure 4 shows the shutdown waveform.

Power-Up

The MAX4480–MAX4483 outputs typically settle within 50µs after power-up. Figure 5 shows the output voltage on power-up and power-down.

Power Supplies and Layout

The MAX4480–MAX4483 operate from a single +2.5V to +5.5V power supply. Bypass the power supply with a 0.1µF capacitor to ground.

Good layout techniques optimize performance by decreasing the amount of stray capacitance at the op amp’s inputs and outputs. To decrease stray capacitance, minimize trace lengths by placing external components close to the op amp’s pins.

Chip Information

PROCESS: BiCMOS

Pin Configurations (continued)

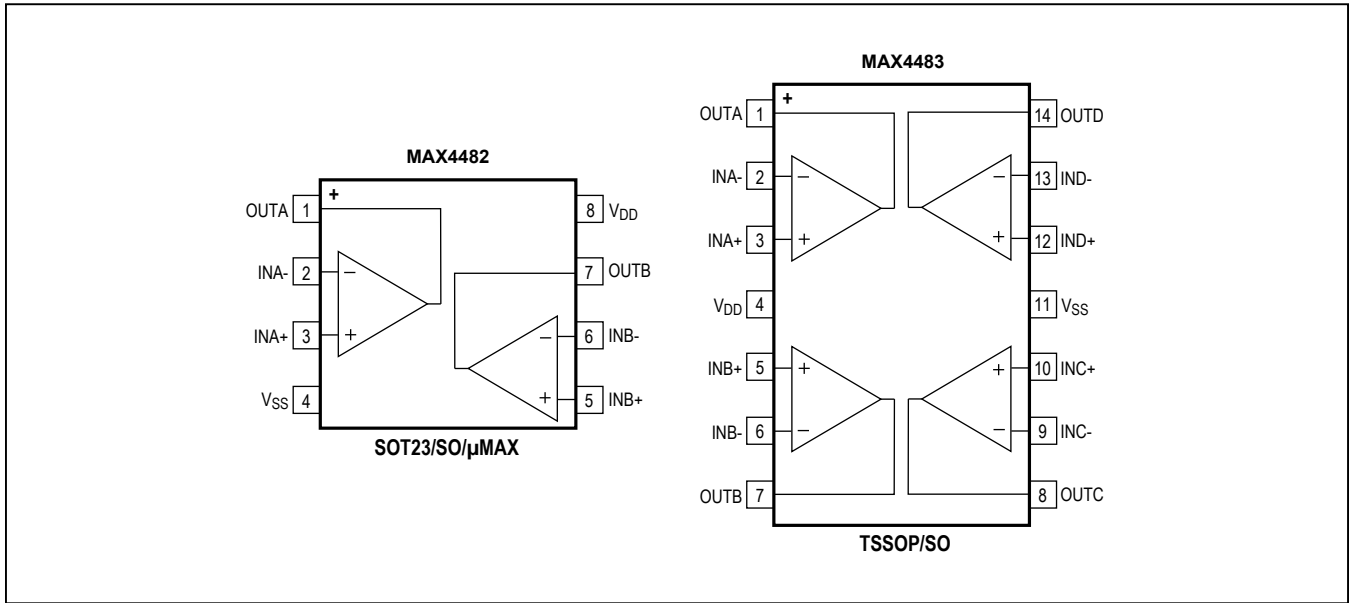

Package Information

For the latest package outline information and land patterns (footprints), go to www.maximintegrated.com/packages. Note that a “+”, “#”, or “-” in the package code indicates RoHS status only. Package drawings may show a different suffix character, but the drawing pertains to the package regardless of RoHS status.

PACKAGE TYPE	PACKAGE CODE	OUTLINE NO.	LAND PATTERN NO.
5 SC70	X5+1	21-0076	90-0188
5 SOT23	U5+1	21-0057	90-0174
6 SC70	X6SN+1	21-0077	90-0189
6 SOT23	U6SN+1	21-0058	90-0175
8 SOT23	K8+5	21-0078	90-0176
8 SO	S8+2	21-0041	90-0096
8 μMAX	U8+1	21-0036	90-0092
14 TSSOP	U14+1	21-0066	90-0113
14 SO	S14+1	21-0041	90-0112

Revision History

REVISION NUMBER	REVISION DATE	DESCRIPTION	PAGES CHANGED
0	10/00	Initial release	—
1	1/01	Released MAX4481, revised <i>Electrical Characteristics</i> and Figures 2 and 4.	1, 2, 3, 8
2	10/12	Added MAX4481MXT/PR2-W and lead-free notation to <i>Ordering Information</i> . Revised <i>Absolute Maximum Ratings</i> with military temp range.	1, 2
3	4/13	Removed –W from MAX4481MXT/PR2 in <i>Ordering Information</i> and revised <i>Absolute Maximum Ratings</i> and updated to MAX4481MXT/PR3+.	1, 2
4	5/14	Removed automotive reference from <i>General Description</i>	1

For pricing, delivery, and ordering information, please contact Maxim Direct at 1-888-629-4642, or visit Maxim Integrated's website at www.maximintegrated.com.

Maxim Integrated cannot assume responsibility for use of any circuitry other than circuitry entirely embodied in a Maxim Integrated product. No circuit patent licenses are implied. Maxim Integrated reserves the right to change the circuitry and specifications without notice at any time. The parametric values (min and max limits) shown in the *Electrical Characteristics* table are guaranteed. Other parametric values quoted in this data sheet are provided for guidance.

Looking for pricing, stock, or lifecycle information?

Click below to explore more details on WIN SOURCE:

 [View MAX4482AUA+](#) on WIN SOURCE

 [Maxim Integrated](#) Information

Optimize Your Supply Chain with WIN SOURCE Solutions

-  Global Sourcing Solution
-  Obsolete Management
-  Cost Control Management
-  Shortage Management
-  Alternative Solution
-  Excess Inventory Management