



**THE DATASHEET OF
MAX6701LKA+T**



**MAX6701-08/
MAX6701A-03A/
MAX6705A-07A**

Low-Voltage, SOT23 μ P Supervisors with Power-Fail In/Out, Manual Reset, and Watchdog Timer

General Description

The MAX6701–MAX6708 microprocessor (μ P) supervisory circuits reduce the complexity and components required to monitor power-supply functions in μ P systems. These devices significantly improve system reliability and accuracy compared to separate ICs or discrete components.

The MAX6701–MAX6708 family provides four functions: a reset output during power-up, power-down, and brownout conditions; an independent watchdog output that goes low if the watchdog input has not been toggled within 1.6s; a 0.62V threshold detector for power-fail warning; and an active-low manual reset input.

The MAX6701–MAX6708 family offers several pinout options to accommodate a variety of multivoltage microprocessor supervision applications.

The MAX6701(A)/MAX6702(A)/MAX6703(A) monitor three supply voltages (one fixed threshold and two adjustable) to drive a single reset output and include a manual reset input and a watchdog timer with an independent output. The MAX6704 monitors a single-supply voltage to drive complementary reset outputs and includes an independent adjustable power-fail-in/power-fail-out comparator, a manual reset input, and a reset-based watchdog timer. The MAX6705(A)/MAX6706(A)/MAX6707(A) monitor a single-supply voltage to drive a single reset output and include an independent adjustable power-fail-in/power-fail-out comparator, a manual reset input, and a watchdog timer with an independent output. The MAX6708 is the same as the MAX6704 but without the watchdog timer function.

See the Detailed Description for differences between non-A and A versions.

Applications

- Computers
- Controllers
- Intelligent Instruments
- Critical μ P Power Monitoring
- White Goods
- Networking
- Telecommunications

Typical Operating Circuit and Selector Guide appear at end of data sheet.

Features

- Small 8-Pin SOT23 Package
- Precision Monitoring of +5.0V, +3.3V, +3.0V, +2.5V Supply Voltages
- 140ms Reset Timeout Delay
- Power-Fail Input with Independent Output; Monitor Inputs Down to 0.62V (MAX6704–MAX6708)
- Dual Adjustable Reset Input for Triple-Voltage Monitoring (MAX6701(A)/MAX6702(A)/MAX6703(A))
- 1.6s Watchdog Timeout Period (MAX6701(A)–MAX6707(A))
- Independent Watchdog Output (MAX6701(A)/MAX6702(A)/MAX6703(A)/MAX6705(A)/MAX6706(A)/MAX6707(A))
- Manual Reset Input
- Four Reset Output Stage Options
Active Low Push-Pull (MAX6701(A), MAX6705(A))
Active Low Open Drain (MAX6703(A), MAX6707(A))
Active High Push-Pull (MAX6702(A), MAX6706(A))
Dual Active Low/High Push-Pull (MAX6704, MAX6708)
- Guaranteed Reset Valid to $V_{CC} = 1V$
- Immune to Short Falling V_{CC} Transients
- Low Cost, Few External Components

Ordering Information

PART	TEMP RANGE	PIN-PACKAGE
MAX6701_KA-T	-40°C to +125°C	8 SOT23
MAX6701A_KA-T	-40°C to +125°C	8 SOT23

Insert the desired suffix letter (from the Threshold Suffix Guide table) into the blank to complete the part number. All devices must be ordered in increments of 2500 pieces. Sample stock is typically held on standard versions only. Contact factory for availability.

Devices are available in both leaded and lead-free packaging. Specify lead-free by replacing “-T” with “+T” when ordering.

Ordering Information continued at end of data sheet.

Pin Configurations



MAX6701-08/
MAX6701A-03A/
MAX6705A-07A

Low-Voltage, SOT23 μ P Supervisors with Power-Fail
In/Out, Manual Reset, and Watchdog Timer

Absolute Maximum Ratings

V_{CC}	-0.3V to +6.0V	Continuous Power Dissipation ($T_A = +70^\circ\text{C}$)	
Open-Drain RESET, \overline{WDO} , \overline{PFO}	-0.3V to +6.0V	8-Pin SOT23 (derate 8.9mW/ $^\circ\text{C}$ above $+70^\circ\text{C}$)	714mW
Push-Pull RESET, RESET, \overline{WDO} , \overline{PFO}	-0.3V to ($V_{CC} + 0.3\text{V}$)	Operating Temperature Range.....	-40°C to $+125^\circ\text{C}$
MR, WDI, PFI, RST_IN1, RST_IN2	-0.3V to ($V_{CC} + 0.3\text{V}$)	Junction Temperature.....	$+150^\circ\text{C}$
Input Current (V_{CC}).....	20mA	Storage Temperature Range.....	-65°C to $+150^\circ\text{C}$
Output Current (\overline{O} , \overline{WDO})	20mA	Lead Temperature (soldering, 10s)	$+300^\circ\text{C}$

Stresses beyond those listed under "Absolute Maximum Ratings" may cause permanent damage to the device. These are stress ratings only, and functional operation of the device at these or any other conditions beyond those indicated in the operational sections of the specifications is not implied. Exposure to absolute maximum rating conditions for extended periods may affect device reliability.

Electrical Characteristics

($V_{CC} = +4.25\text{V}$ to $+5.5\text{V}$ for L/M versions, $V_{CC} = +2.55\text{V}$ to $+3.6\text{V}$ for the T/S/R versions, $V_{CC} = +2.1\text{V}$ to $+2.75\text{V}$ for the Z/Y versions. $T_A = -40^\circ\text{C}$ to $+125^\circ\text{C}$, unless otherwise specified. Typical values are at $T_A = +25^\circ\text{C}$.) (Note 1)

PARAMETER	SYMBOL	CONDITIONS	MIN	TYP	MAX	UNITS	
Operating Voltage Range	V_{CC}	$T_A = 0^\circ\text{C}$ to $+125^\circ\text{C}$	1.0		5.5	V	
		$T_A = -40^\circ\text{C}$ to $+125^\circ\text{C}$	1.2		5.5		
Supply Current MR Unconnected	I_{CC}	$V_{CC} < 5.5\text{V}$, no load		12	25	μA	
		$V_{CC} < 3.6\text{V}$, no load		9	20		
		$V_{CC} < 3.6\text{V}$, no load (MAX6708 only)		6	20		
V_{CC} Reset Threshold (V_{CC} falling)	V_{TH}	MAX670_L/MAX670_AL	$T_A = -40^\circ\text{C}$ to $+85^\circ\text{C}$	4.50	4.63	4.75	V
			$T_A = -40^\circ\text{C}$ to $+125^\circ\text{C}$	4.47		4.78	
		MAX670_M/MAX670_AM	$T_A = -40^\circ\text{C}$ to $+85^\circ\text{C}$	4.25	4.38	4.50	
			$T_A = -40^\circ\text{C}$ to $+125^\circ\text{C}$	4.22		4.53	
		MAX670_T/MAX670_AT	$T_A = -40^\circ\text{C}$ to $+85^\circ\text{C}$	3.00	3.08	3.15	
			$T_A = -40^\circ\text{C}$ to $+125^\circ\text{C}$	2.97		3.17	
		MAX670_S/MAX670_AS	$T_A = -40^\circ\text{C}$ to $+85^\circ\text{C}$	2.85	2.93	3.00	
			$T_A = -40^\circ\text{C}$ to $+125^\circ\text{C}$	2.83		3.02	
		MAX670_R/MAX670_AR	$T_A = -40^\circ\text{C}$ to $+85^\circ\text{C}$	2.55	2.63	2.70	
			$T_A = -40^\circ\text{C}$ to $+125^\circ\text{C}$	2.53		2.72	
		MAX670_Z/MAX670_AZ	$T_A = -40^\circ\text{C}$ to $+85^\circ\text{C}$	2.25	2.32	2.38	
			$T_A = -40^\circ\text{C}$ to $+125^\circ\text{C}$	2.24		2.40	
		MAX670_Y/MAX670_AY	$T_A = -40^\circ\text{C}$ to $+85^\circ\text{C}$	2.12	2.19	2.25	
			$T_A = -40^\circ\text{C}$ to $+125^\circ\text{C}$	2.11		2.27	
Reset Threshold Temperature Coefficient	ΔV_{TH}		60			ppm/ $^\circ\text{C}$	
V_{CC} to Reset Output Delay		V_{CC} falling at 10mV/ μs		12		μs	
Reset Timeout Period	t_{RP}	$T_A = -40^\circ\text{C}$ to $+85^\circ\text{C}$	140	200	280	ms	
		$T_A = -40^\circ\text{C}$ to $+125^\circ\text{C}$	120		300		
V_{CC} Falling to \overline{WDO} Delay		MAX6701(A)/MAX6702(A)/MAX6703(A)/MAX6705(A)/ MAX6706(A)/MAX6707(A)		5		μs	
PFI, RST_IN1, RST_IN2 Threshold		$V_{CC} = 1.8\text{V}$ to 5.5V	$T_A = -40^\circ\text{C}$ to $+85^\circ\text{C}$	602	618	634	mV
			$T_A = -40^\circ\text{C}$ to $+125^\circ\text{C}$	593		642	
PFI Hysteresis				6		mV	

MAX6701-08/
MAX6701A-03A/
MAX6705A-07A

Low-Voltage, SOT23 μ P Supervisors with Power-Fail
In/Out, Manual Reset, and Watchdog Timer

Electrical Characteristics (continued)

(V_{CC} = +4.25V to +5.5V for L/M versions, V_{CC} = +2.55V to +3.6V for the T/S/R versions, V_{CC} = +2.1V to +2.75V for the Z/Y versions. T_A = -40°C to +125°C, unless otherwise specified. Typical values are at T_A = +25°C.) (Note 1)

PARAMETER	SYMBOL	CONDITIONS	MIN	TYP	MAX	UNITS
PFI, RST_IN1, RST_IN2 Leakage Current		(Note 2)	T_A = -40°C to +85°C	-50	+50	nA
		T_A = -40°C to +125°C	-200	+200		
PFI to \overline{PFO} Delay	t_{PF}			1		μ s
\overline{MR} Input Voltage	V_{IL}			0.3 x V_{CC}		V
	V_{IH}		0.7 x V_{CC}			
\overline{MR} Minimum Input Pulse			1			μ s
\overline{MR} Glitch Rejection				100		ns
\overline{MR} to Reset Delay	t_{MD}			200		ns
V_{CC} Rising to \overline{WDO} Delay		MAX6701(A)/MAX6702(A)/MAX6703(A)/ MAX6705(A)/MAX6706(A)/MAX6707(A)		100		ns
\overline{MR} Pullup Resistance			25	50	75	k Ω
Watchdog Timeout Period	t_{WD}	T_A = -40°C to +85°C	1.12	1.6	2.4	s
		T_A = -40°C to +125°C	0.96		2.52	
WDI Pulse Width	t_{WDI}	(Note 2)	50			ns
WDI Input Voltage	V_{IL}			0.3 x V_{CC}		V
	V_{IH}		0.7 x V_{CC}			
WDI Input Current	I_{WDI}	V_{WDI} = 0V or V_{CC}	-1		+1	μ A
RESET, WDO Output Low (Push-Pull or Open Drain)	V_{OL}	$V_{CC} \geq 1.0V$, $I_{SINK} = 50\mu A$, output asserted ($T_A = 0^\circ C$ to +125°C)			0.3	V
		$V_{CC} \geq 1.2V$, $I_{SINK} = 100\mu A$, output asserted			0.3	
		$V_{CC} \geq 2.55V$, $I_{SINK} = 1.2mA$, output asserted			0.3	
		$V_{CC} \geq 4.25V$, $I_{SINK} = 3.2mA$, output asserted			0.4	
PFO Output Low (Push-Pull or Open Drain)	V_{OL}	$V_{CC} \geq 1.80V$, $I_{SINK} = 200\mu A$, output asserted			0.3	V
		$V_{CC} \geq 2.55V$, $I_{SINK} = 1.2mA$, output asserted			0.3	
		$V_{CC} \geq 4.25V$, $I_{SINK} = 3.2mA$, output asserted			0.4	
\overline{RESET} , \overline{WDO} , \overline{PFO} Output High (Push-Pull Only)	V_{OH}	$V_{CC} \geq 2.7V$, $I_{SOURCE} = 500\mu A$, output not asserted	0.8 x V_{CC}		V	
		$V_{CC} \geq 4.75V$, $I_{SOURCE} = 800\mu A$, output not asserted	0.8 x V_{CC}			
\overline{RESET} , \overline{WDO} , \overline{PFO} Output Open-Drain Leakage Current	I_{LKG}	$V_{CC} > V_{TH}$, output not asserted			1.0	μ A
RESET Output High (Push-Pull Only)	V_{OH}	$V_{CC} \geq 1.0V$, $I_{SOURCE} = 1\mu A$, reset asserted ($T_A = 0^\circ C$ to +125°C)	0.8 x V_{CC}		V	
		$V_{CC} \geq 1.2V$, $I_{SOURCE} = 50\mu A$, reset asserted	0.8 x V_{CC}			
		$V_{CC} \geq 2.55V$, $I_{SOURCE} = 500\mu A$, reset asserted	0.8 x V_{CC}			
		$V_{CC} \geq 4.25V$, $I_{SOURCE} = 800\mu A$, reset asserted	0.8 x V_{CC}			
RESET Output Low (Push-Pull Only)	V_{OL}	$V_{CC} \geq 2.7V$, $I_{SINK} = 1.2mA$, reset not asserted			0.3	V
		$V_{CC} \geq 4.75V$, $I_{SINK} = 3.2mA$, reset not asserted			0.4	

Note 1: Over-temperature limits are guaranteed by design and not production tested. Devices are tested at T_A = +25°C.

Note 2: Guaranteed by design. Not production tested.

Typical Operating Characteristics

($T_A = +25^\circ\text{C}$, unless otherwise noted.)

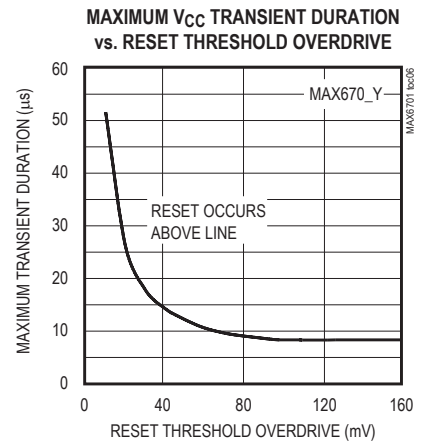
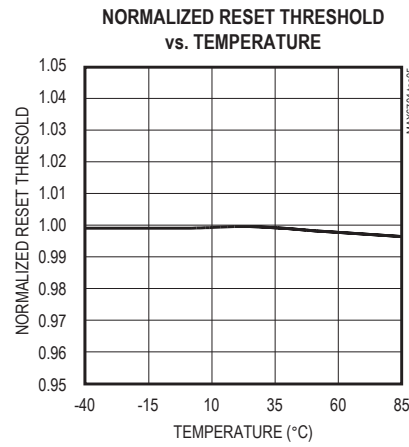
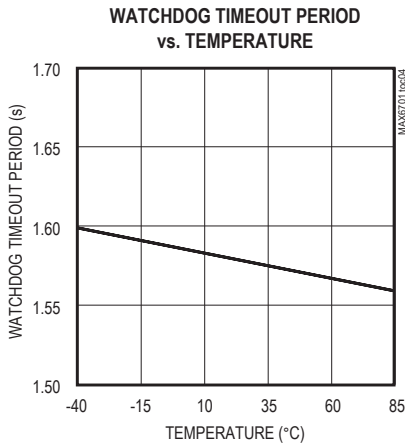
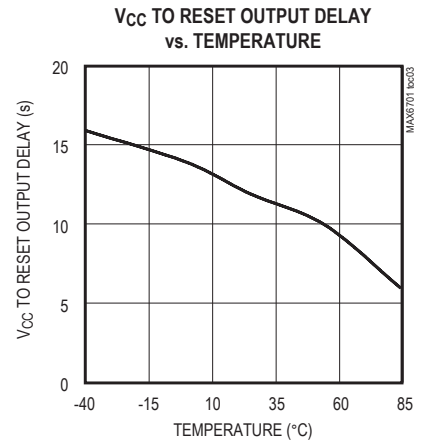
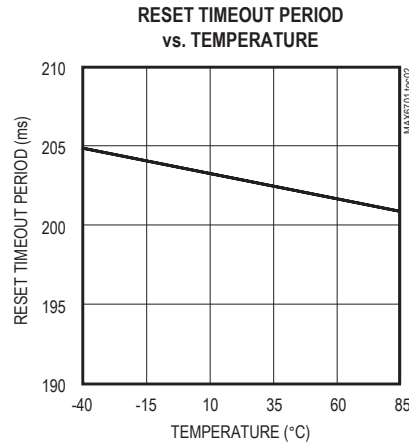
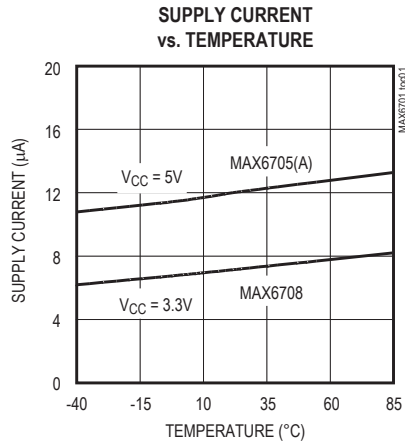

MAX6701-08/
 MAX6701A-03A/
 MAX6705A-07A

Low-Voltage, SOT23 μ P Supervisors with Power-Fail
 In/Out, Manual Reset, and Watchdog Timer

Pin Description

PIN				NAME	FUNCTION
MAX6701(A) MAX6702(A) MAX6703(A)	MAX6704	MAX6705(A) MAX6706(A) MAX6707(A)	MAX6708		
1	1	1	1	$\overline{\text{MR}}$	Active-Low, Manual Reset Input, Internal 50k Ω Pullup to V_{CC} . Pull low to force a reset. Reset remains active as long as $\overline{\text{MR}}$ is low and the reset timeout period after $\overline{\text{MR}}$ goes high. Leave unconnected or connect to V_{CC} if unused. $\overline{\text{WDO}}$ deasserts when $\overline{\text{MR}}$ is low (MAX6701(A)/MAX6702(A)/MAX6703(A)/ MAX6705(A)/ MAX6706(A)/MAX6707(A) only)
2	2	2	2	V_{CC}	Supply Voltage for MAX6701–MAX6708 and Input for Primary Reset Threshold Monitor. Push-pull outputs are powered by V_{CC} .
3	3	3	3	GND	Ground
—	4	4	4	PFI	Power-Fail Voltage Monitor Input. High-impedance input for internal power-fail comparator. Connect this pin to an external resistive-divider network to set the reset threshold voltage; 0.62V (typ) threshold. Connect to GND or V_{CC} when not used.
—	5	5	5	$\overline{\text{PFO}}$	Power-Fail Monitor Output. Open drain or push-pull active low. $\overline{\text{PFO}}$ goes low when PFI is less than 0.62V.
6	6	6	—	WDI	Watchdog Input. If WDI remains high or low for longer than the watchdog timeout period, the internal watchdog timer runs out and $\overline{\text{WDO}}$ is asserted. $\overline{\text{WDO}}$ is asserted low after each watchdog overflow and remains low until the watchdog timer is cleared (the reset output is not affected). The internal watchdog timer clears whenever a V_{CC} /RST_IN1/RST_IN2 reset is asserted, the manual reset is asserted, or WDI sees a rising or falling edge. The watchdog timer remains cleared until the reset output is deasserted. On the MAX6704, $\overline{\text{RESET}}$ pulse asserts for the reset timeout period after each watchdog timeout overflow. The watchdog timer cannot be disabled.
—	—	—	6	N.C.	No Connection. Not internally connected.
7	7	7	7	$\overline{\text{RESET}}$	Active-Low Reset Output (Open Drain or Push-Pull). $\overline{\text{RESET}}$ changes from high to low when the V_{CC} input drops below the selected reset threshold (or RST_IN1/RST_IN2 for the MAX6701(A)/MAX6702(A)/MAX6703(A), $\overline{\text{MR}}$ is pulled low, or the watchdog triggers a reset (MAX6704 only). $\overline{\text{RESET}}$ remains low for the reset timeout period after the reset conditions are terminated.

Pin Description (continued)

PIN				NAME	FUNCTION
MAX6701(A) MAX6702(A) MAX6703(A)	MAX6704	MAX6705(A) MAX6706(A) MAX6707(A)	MAX6708		
8	—	8	—	$\overline{\text{WDO}}$	Active-Low Watchdog Output (Open Drain or Push-Pull). $\overline{\text{WDO}}$ is asserted whenever the watchdog times out and V_{CC} or the reset inputs are below their respective thresholds. $\overline{\text{WDO}}$ deasserts after a valid WDI transition without a reset timeout period. In the A versions, $\overline{\text{WDO}}$ deasserts without a timeout delay when V_{CC} , RST_IN1, and RST_IN2 rises above its threshold. Pull MR low to assert $\overline{\text{WDO}}$ (MAX6701/MAX6702/MAX6703/MAX6705/MAX6706/MAX6707 only). Pull MR low to deassert $\overline{\text{WDO}}$ (MAX6701(A)/MAX6702(A) / MAX6703(A)/ MAX6705(A)/MAX6706(A)MAX6707(A) only)
7*	8	7*	8	RESET	Active-High Reset Output (Push-Pull). RESET changes from low to high when the V_{CC} input drops below the selected reset threshold (or RST_IN1/RST_IN2 for MAX6701(A)/MAX6702(A)/ MAX6703(A), MR is pulled low, or the watchdog triggers a reset (MAX6704 only). RESET remains high for the reset timeout period after the reset conditions are terminated.
4	—	—	—	RST_IN1	Input for User-Adjustable V_{CC2} Monitor. High-impedance input for second internal reset comparator. Connect this pin to an external resistive-divider network to set the reset threshold voltage; 0.62V (typ) threshold. Connect to V_{CC} when not used. Reset is asserted when either V_{CC} , RST_IN1, or RST_IN2 are below threshold.
5	—	—	—	RST_IN2	Input for User-Adjustable V_{CC3} Monitor. High-impedance input for third internal reset comparator. Connect this pin to an external resistive-divider network to set the reset threshold voltage; 0.62V (typ) threshold. Connect to V_{CC} when not used. Reset is asserted when either V_{CC} , RST_IN1, or RST_IN2 are below threshold.

*RESET active-high for the MAX6702(A)/MAX6706(A).

Detailed Description

Figures 1, 2, and 3 are functional diagrams for the MAX6705(A)/MAX6706(A)/MAX6707(A), MAX6704/MAX6708, and MAX6701(A)/MAX6702(A)/MAX6703(A), respectively.

Reset Output

A microprocessor's (μ P's) reset input starts the μ P in a known state. The MAX6701–MAX6708 assert reset during power-up and prevent code execution errors during power-down or brownout conditions.

On power-up, once V_{CC} reaches 1V, $\overline{\text{RESET}}$ is a guaranteed logic-low of 0.4V or less. As V_{CC} rises,

$\overline{\text{RESET}}$ stays low. After V_{CC} , RST_IN1, or RST_IN2 rise above the reset threshold, an internal timer holds $\overline{\text{RESET}}$ low for about 200ms. $\overline{\text{RESET}}$ pulses low whenever V_{CC} dips below the reset threshold, including brownout conditions. If a brownout occurs in the middle of a previously initiated reset pulse, the pulse continues for at least another 140ms. On power-down, once V_{CC} falls below the reset threshold, $\overline{\text{RESET}}$ stays low and is guaranteed to be 0.4V or less, until V_{CC} drops below 1V. The MAX6702(A)/MAX6704/MAX6706(A)/MAX6708 active-high RESET output is the complement of the $\overline{\text{RESET}}$ output, and is guaranteed to be valid with V_{CC} down to 1V.

MAX6701-08/
MAX6701A-03A/
MAX6705A-07A

Low-Voltage, SOT23 μ P Supervisors with Power-Fail
In/Out, Manual Reset, and Watchdog Timer



Figure 1. MAX6705(A)/MAX6706(A)/MAX6707(A) Functional Diagram



Figure 3. MAX6701(A)/MAX6702(A)/MAX6703(A) Functional Diagram



Figure 2. MAX6704/MAX6708 Functional Diagram

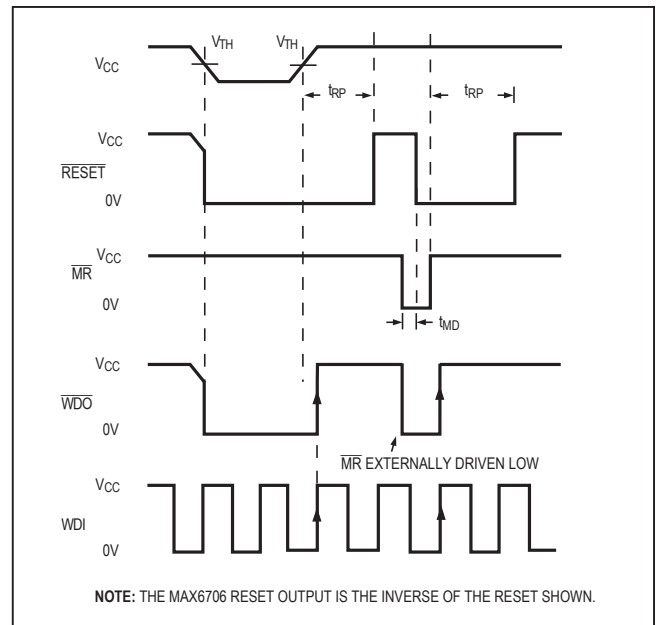

Figure 4. MAX6705/MAX6706/MAX6707 RESET, MR, WDO, and WDI Timing

Standard- vs. A-Version Comparison

The MAX6701/MAX6702/MAX6703/MAX6705/MAX6706/
MAX6707s' \overline{WDO} latches low when one of the following
events occurs:

- The watchdog timer times out (1.6s, typ).
- V_{CC} , RST_IN1, or RST_IN2 is below its reset
threshold.
- \overline{MR} is pulled low.
- \overline{WDO} only deasserts with a valid WDI transition.

The MAX6701(A)/MAX6702(A)/MAX6703(A)/MAX6705(A)/
MAX6706(A)/MAX6707(A)s' \overline{WDO} asserts when either
 V_{CC} , RST_IN1, or RST_IN2 is below its reset thresh-
old. \overline{WDO} deasserts without a timeout delay when the
undervoltage situation has expired. \overline{WDO} is latched low
when the watchdog timer elapses without seeing a WDI
transition. \overline{WDO} deasserts with a valid WDI transition
OR by pulling \overline{MR} low.

See Figures 4 and 5 for standard-version timing. See
Figures 6 and 7 for A-version timing.

Watchdog Timer

The MAX6701–MAX6707 watchdog circuit monitors the
 μ P's activity. If the μ P does not toggle the WDI within 1.6s,
 \overline{WDO} goes low. When \overline{RESET} is asserted, the watchdog
timer stays cleared and does not count. As soon as reset
is released, the timer starts counting. \overline{WDO} deasserts
after a valid transition is detected at WDI. Pulses as short
as 50ns can be detected.

Typically, \overline{WDO} is connected to the NMI input of a μ P.
When V_{CC} , RST_IN1, or RST_IN2 drop below the reset

threshold, \overline{WDO} goes low whether or not the watchdog
timer has timed out. Normally this would trigger an NMI,
but \overline{RESET} goes low simultaneously, and thus overrides
the NMI.

The MAX6704 watchdog circuit does not have an inde-
pendent watchdog output (\overline{WDO}). If the μ P does not
toggle the watchdog input within 1.6s, the MAX6704
asserts a reset output pulse for the reset timeout period.

Manual Reset

The manual reset input (\overline{MR}) allows reset to be
triggered by a pushbutton switch. The switch is
effectively debounced by the reset pulse width. \overline{MR} is
CMOS logic compatible, so it can be driven by an external
logic line. \overline{MR} can be used to force a watchdog timeout to
generate a reset pulse in the MAX6701(A)/MAX6702(A)/
MAX6703(A)/MAX6705(A)/MAX6706(A)/MAX6707(A) by
connecting \overline{WDO} to \overline{MR} .

Power-Fail Comparator

The uncommitted power-fail comparator can be used
for various purposes because its noninverting input and
output are externally available. The inverting input is
internally connected to a 0.62V reference. To build an
early warning circuit for power failure, connect the PFI
pin to a voltage-divider (see the *Typical Operating
Circuit*). Choose the voltage-divider ratio so that the
voltage at PFI falls below 0.62V just before the regulator
drops out. Use PFO to interrupt the μ P so it can prepare
for an orderly power-down. The low-input current at this
pin allows for large resistor values in the divider.



Figure 5. MAX6701/MAX6702/MAX6703/MAX6705/MAX6706/
MAX6707 Watchdog



Figure 6. MAX6701(A)/MAX6702(A)/MAX6703(A)/
MAX6705(A)/MAX6706(A)/MAX6707(A) \overline{RESET} , \overline{MR} , and
 \overline{WDO} Timing with WDI Three-States



Figure 7. MAX6701(A)/MAX6702(A)/MAX6703(A)/
MAX6705(A)/ MAX6706(A)/MAX6707(A) Watchdog Timing

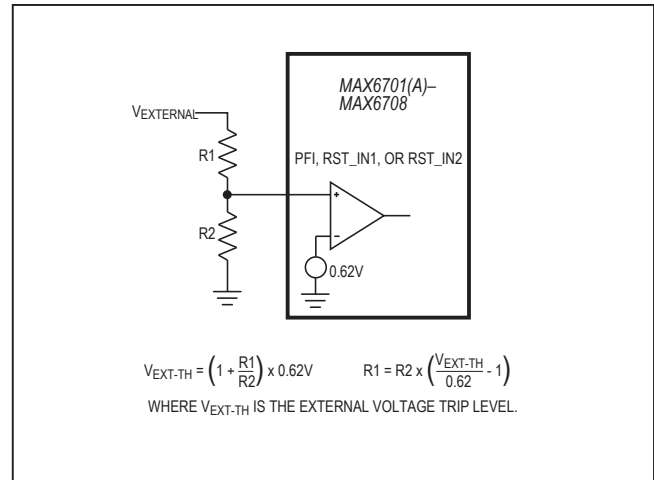

Figure 8. Calculating Adjustable Voltage Thresholds

Reset Input

The MAX6701(A)/MAX6702(A)/MAX6703(A) include two adjustable reset inputs for monitoring up to a total of three system voltages (including V_{CC}). The thresholds for the monitored RST_IN supplies are externally set with resistor-divider networks (Figure 8). The reset output is asserted if any of the monitored supplies (V_{CC} , RST_IN1, or RST_IN2) go below its specified threshold and remains asserted for the reset timeout period after all supplies are above their thresholds.

Applications Information

Ensuring a Valid $\overline{\text{RESET}}$ Output Down to $V_{CC} = 0$

When V_{CC} falls below 1V, the MAX6701–MAX6708 $\overline{\text{RESET}}$ output no longer sinks current; it becomes an open circuit. High-impedance CMOS logic inputs can drift to undetermined voltages if left undriven. If a pull-down resistor is added to the $\overline{\text{RESET}}$ pin, as shown in Figure 9, any stray charge or leakage currents are drained to ground, holding $\overline{\text{RESET}}$ low. A resistor value ($R1$) is not critical; 100k Ω is large enough not to load $\overline{\text{RESET}}$ and small enough to pull $\overline{\text{RESET}}$ to ground. This application works for push-pull output only (not for open-drain resets).

Monitoring Other System Voltages

Other systems can be monitored by connecting a voltage-divider to PFI and adjusting the ratio appropriately. In noisy systems, a capacitor between PFI and GND reduces the power-fail circuit's sensitivity to high-frequency noise on the line being monitored. Reset can be asserted on other voltages in addition to the V_{CC} supply line. Connect $\overline{\text{PFO}}$ to $\overline{\text{MR}}$ to initiate a reset output pulse when PFI drops below 0.62V. Figure 10 shows the MAX6704–MAX6708 configured to assert a reset output when the secondary supply falls below the reset threshold.

Generating a Reset from Watchdog Overflow

Connect $\overline{\text{WDO}}$ to $\overline{\text{MR}}$ to force a watchdog timeout to generate a reset pulse for only the reset timeout period on the MAX6701(A)/MAX6702(A)/MAX6703(A)/MAX6705(A)/MAX6706(A)/MAX6707(A). When the MAX6704 watchdog times out, reset outputs are automatically asserted (no external connections required). For the MAX6701/MAX6702/MAX6703/MAX6705/MAX6706/MAX6707 non-A versions, do not connect $\overline{\text{WDO}}$ to $\overline{\text{MR}}$; this creates a locked condition.

MAX6701-08/
MAX6701A-03A/
MAX6705A-07A

Low-Voltage, SOT23 μ P Supervisors with Power-Fail
In/Out, Manual Reset, and Watchdog Timer



Figure 9. $\overline{\text{RESET}}$ Valid to Ground Circuit



Figure 10. Monitoring Other System Voltages

Selector Guide

PART	$\overline{\text{RESET}}$ PP LOW	RESET PP HIGH	$\overline{\text{RESET}}$ OD-LOW	WDI	$\overline{\text{WDO}}$	PFI, PFO	RST_IN1, RST_IN2
MAX6701	✓	—	—	✓	✓ PP	—	✓
MAX6701A*	✓	—	—	✓	✓ PP	—	✓
MAX6702	—	✓	—	✓	✓ PP	—	✓
MAX6702A*	—	✓	—	✓	✓ PP	—	✓
MAX6703	—	—	✓	✓	✓ OD	—	✓
MAX6703A*	—	—	✓	✓	✓ OD	—	✓
MAX6704	✓	✓	—	✓	—	✓ PP	—
MAX6705	✓	—	—	✓	✓ PP	✓ PP	—
MAX6705A*	✓	—	—	✓	✓ PP	✓ PP	—
MAX6706	—	✓	—	✓	✓ PP	✓ PP	—
MAX6706A*	—	✓	—	✓	✓ PP	✓ PP	—
MAX6707	—	—	✓	✓	✓ OD	✓ OD	—
MAX6707A*	—	—	✓	✓	✓ OD	✓ OD	—
MAX6708	✓	✓	—	—	—	✓ PP	—

PP = push-pull, OD = open drain.

* $\overline{\text{WDO}}$ deasserts when $\overline{\text{MR}}$ is pulled low. See the Standard- vs. A-Version Comparison section for the differences on $\overline{\text{WDO}}$.

Threshold Suffix Guide

SUFFIX	RESET THRESHOLD (V)
L	4.63
M	4.38
T	3.08
S	2.93
R	2.63
Z	2.32
Y	2.19

Bold indicates standard version.

MAX6701-08/
MAX6701A-03A/
MAX6705A-07A

Low-Voltage, SOT23 μ P Supervisors with Power-Fail
In/Out, Manual Reset, and Watchdog Timer

Pin Configurations (continued)



Typical Operating Circuit



Package Information

For the latest package outline information and land patterns (footprints), go to www.maximintegrated.com/packages. Note that a "+", "#", or "-" in the package code indicates RoHS status only. Package drawings may show a different suffix character, but the drawing pertains to the package regardless of RoHS status.

PACKAGE TYPE	PACKAGE CODE	OUTLINE NO.	LAND PATTERN NO.
8 SOT23	K8+2	21-0078	90-0176

Ordering Information (continued)

PART	TEMP RANGE	PIN-PACKAGE
MAX6702_ KA-T	-40°C to +125°C	8 SOT23
MAX6702A_ KA-T	-40°C to +125°C	8 SOT23
MAX6703_ KA-T	-40°C to +125°C	8 SOT23
MAX6703A_ KA-T	-40°C to +125°C	8 SOT23
MAX6704_ KA-T	-40°C to +125°C	8 SOT23
MAX6705_ KA-T	-40°C to +125°C	8 SOT23
MAX6705A_ KA-T	-40°C to +125°C	8 SOT23
MAX6706_ KA-T	-40°C to +125°C	8 SOT23
MAX6706A_ KA-T	-40°C to +125°C	8 SOT23
MAX6707_ KA-T	-40°C to +125°C	8 SOT23
MAX6707A_ KA-T	-40°C to +125°C	8 SOT23
MAX6708_ KA-T	-40°C to +125°C	8 SOT23

Insert the desired suffix letter (from the Threshold Suffix Guide table) into the blank to complete the part number. All devices must be ordered in increments of 2500 pieces. Sample stock is typically held on standard versions only. Contact factory for availability.

Devices are available in both leaded and lead(Pb)-free packaging. Specify lead-free by replacing "-T" with "+T" when ordering.

T = Tape and reel.

Chip Information

TRANSISTOR COUNT: 716

PROCESS: BiCMOS

MAX6701-08/
MAX6701A-03A/
MAX6705A-07A

Low-Voltage, SOT23 μ P Supervisors with Power-Fail
In/Out, Manual Reset, and Watchdog Timer

Revision History

REVISION NUMBER	REVISION DATE	DESCRIPTION	PAGES CHANGED
4	5/14	No IV OPNs; removed Automotive reference from <i>Applications</i> section	1

For pricing, delivery, and ordering information, please contact Maxim Direct at 1-888-629-4642, or visit Maxim Integrated's website at www.maximintegrated.com.

Maxim Integrated cannot assume responsibility for use of any circuitry other than circuitry entirely embodied in a Maxim Integrated product. No circuit patent licenses are implied. Maxim Integrated reserves the right to change the circuitry and specifications without notice at any time. The parametric values (min and max limits) shown in the Electrical Characteristics table are guaranteed. Other parametric values quoted in this data sheet are provided for guidance.

Looking for pricing, stock, or lifecycle information?

Click below to explore more details on WIN SOURCE:

 [View MAX6701LKA+T on WIN SOURCE](#)

 [Maxim Integrated](#) Information

Optimize Your Supply Chain with WIN SOURCE Solutions

-  Global Sourcing Solution
-  Obsolete Management
-  Cost Control Management
-  Shortage Management
-  Alternative Solution
-  Excess Inventory Management