



**THE DATASHEET OF  
TLVH431ACDBVT**



## TLVH431, TLVH432 Low-Voltage Adjustable Precision Shunt Regulators

### 1 Features

- Low-Voltage Operation: Down to 1.24 V
- Reference Voltage Tolerances at 25°C
  - 0.5% for B Grade
  - 1% for A Grade
  - 1.5% for Standard Grade
- Adjustable Output Voltage,  $V_O = V_{REF}$  to 18 V
- Wide Operating Cathode Current Range: 100  $\mu$ A to 70 mA
- 0.25- $\Omega$  Typical Output Impedance
- –40°C to +125°C Specifications
- TLVH432 Provides Alternative Pinouts for SOT-23-3 and SOT-89 Packages
- Ultra-Small SC-70 Package Offers 40% Smaller Footprint than SOT-23-3

### 2 Applications

- Adjustable Voltage and Current Referencing
- Secondary Side Regulation in Flyback SMPSs
- Zener Replacement
- Voltage Monitoring
- Comparator with Integrated Reference

### 3 Description

The TLVH431 and TLVH432 devices are low-voltage 3-terminal adjustable voltage references, with specified thermal stability over applicable industrial and commercial temperature ranges. Output voltage can be set to any value between  $V_{REF}$  (1.24 V) and 18 V with two external resistors (see Figure 19). These devices operate from a lower voltage (1.24 V) than the widely used TL431 and TL1431 shunt-regulator references.

When used with an optocoupler, the TLVH431 and TLVH432 devices are ideal voltage references in isolated feedback circuits for 3-V to 3.3-V switching-mode power supplies. They have a typical output impedance of 0.25  $\Omega$ . Active output circuitry provides a very sharp turn-on characteristic, making the TLVH431 and TLVH432 devices excellent replacements for low-voltage Zener diodes in many applications, including on-board regulation and adjustable power supplies.

The TLVH432 device is identical to the TLVH431 device, but is offered with different pinouts for the 3-pin SOT-23 and SOT-89 packages.

#### Device Information<sup>(1)</sup>

PART NUMBER	PACKAGE	BODY SIZE (NOM)
TLVH43xxDBZ	SOT-23 (5)	2.90 mm x 1.60 mm
TLVH43xxDBZ	SOT-23 (3)	2.92 mm x 1.30 mm
TLVH43xxDCK	SC70 (6)	2.00 mm x 1.25 mm
TLVH43xxLP	TO-92 (3)	4.30 mm x 4.30 mm
TLVH43xxPK	SOT-89 (3)	4.50 mm x 2.50 mm

(1) For all available packages, see the orderable addendum at the end of the data sheet.

#### Simplified Schematic

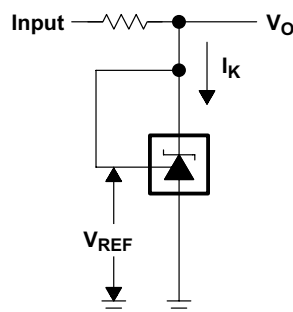

## Table of Contents

<b>1 Features</b> .....	<b>1</b>	8.3 Feature Description.....	17
<b>2 Applications</b> .....	<b>1</b>	8.4 Device Functional Modes.....	18
<b>3 Description</b> .....	<b>1</b>	<b>9 Applications and Implementation</b> .....	<b>19</b>
<b>4 Revision History</b> .....	<b>2</b>	9.1 Application Information.....	19
<b>5 Pin Configuration and Functions</b> .....	<b>3</b>	9.2 Typical Applications .....	20
<b>6 Specifications</b> .....	<b>4</b>	<b>10 Power Supply Recommendations</b> .....	<b>24</b>
6.1 Absolute Maximum Ratings .....	4	<b>11 Layout</b> .....	24
6.2 ESD Ratings.....	4	11.1 Layout Guidelines .....	24
6.3 Recommended Operating Conditions.....	4	11.2 Layout Example .....	24
6.4 Thermal Information .....	4	<b>12 Device and Documentation Support</b> .....	<b>25</b>
6.5 TLVH43x Electrical Characteristics.....	5	12.1 Documentation Support .....	25
6.6 TLVH43xA Electrical Characteristics .....	6	12.2 Receiving Notification of Documentation Updates	25
6.7 TLVH43xB Electrical Characteristics .....	7	12.3 Community Resources.....	25
6.8 Typical Characteristics.....	8	12.4 Related Links .....	25
<b>7 Parameter Measurement Information</b> .....	<b>15</b>	12.5 Trademarks .....	25
<b>8 Detailed Description</b> .....	<b>16</b>	12.6 Electrostatic Discharge Caution.....	25
8.1 Overview .....	16	12.7 Glossary .....	25
8.2 Functional Block Diagram .....	16	<b>13 Mechanical, Packaging, and Orderable Information</b> .....	<b>26</b>

## 4 Revision History

NOTE: Page numbers for previous revisions may differ from page numbers in the current version.

Changes from Revision J (January 2015) to Revision K	Page
• Changed data sheet title.....	1
• Updated pinout images and <i>Pin Functions</i> table.....	3
• Deleted D package from <i>Pin Functions</i> table .....	3
• Added <i>Receiving Notification of Documentation Updates</i> section and <i>Community Resources</i> section .....	25

Changes from Revision I (September 2009) to Revision J	Page
• Added <i>Applications</i> , <i>Device Information</i> table, <i>Pin Functions</i> table, <i>ESD Ratings</i> table, <i>Thermal Information</i> table, <i>Typical Characteristics</i> , <i>Feature Description</i> section, <i>Device Functional Modes</i> , <i>Application and Implementation</i> section, <i>Power Supply Recommendations</i> section, <i>Layout</i> section, <i>Device and Documentation Support</i> section, and <i>Mechanical, Packaging, and Orderable Information</i> section. ....	1
• Deleted <i>Ordering Information</i> table. ....	1

## 5 Pin Configuration and Functions

**TLVH431 DBV Package  
5-Pin SOT-23  
Top View**



NC – No internal connection

\* Pin 2 is attached to Substrate and must be connected to ANODE or left open.

**TLVH431 DBZ Package  
3-Pin SOT-23  
Top View**

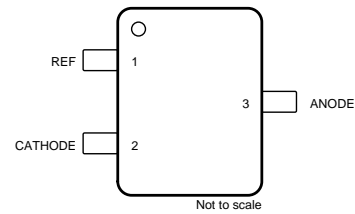

**TLVH432 DBZ Package  
3-Pin SOT-23  
Top View**

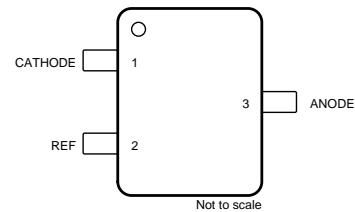

**TLVH431 DCK Package  
6-Pin SC70  
Top View**

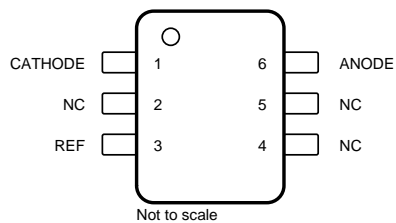

**TLVH431 PK Package  
3-Pin SOT-89  
Top View**

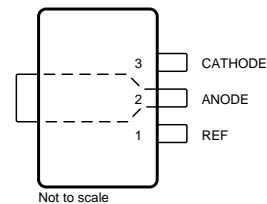

**TLVH431 LP Package  
3-Pin TO-92  
Top View**

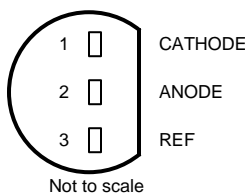

**TLVH432 PK Package  
3-Pin SOT-89  
Top View**



### Pin Functions

NAME	PIN					TYPE	DESCRIPTION		
	TLVH431 DBZ	TLVH431 DBV	TLVH431 LP	TLVH431 DCK	TLVH431 PK			TLVH432 DBZ	TLVH432 PK
CATHODE	2	3	1	1	3	1	1	I/O	Shunt Current/Voltage input
REF	1	4	3	3	1	2	3	I	Threshold relative to common anode
ANODE	3	5	2	6	2	3	2	O	Common pin, normally connected to ground
NC	—	1	—	2, 4, 5	—	—	—	I	No Internal Connection
*	—	2	—	—	—	—	—	I	Substrate Connection

## 6 Specifications

### 6.1 Absolute Maximum Ratings

over operating free-air temperature range (unless otherwise noted)<sup>(1)</sup>

		MIN	MAX	UNIT
$V_{KA}$	Cathode voltage <sup>(2)</sup>		20	V
$I_K$	Cathode current	-25	80	mA
$I_{ref}$	Reference current	-0.05	3	mA
$T_J$	Operating virtual junction temperature		150	°C
$T_{stg}$	Storage temperature	-65	150	°C

- (1) Stresses beyond those listed under *Absolute Maximum Ratings* may cause permanent damage to the device. These are stress ratings only, which do not imply functional operation of the device at these or any other conditions beyond those indicated under *Recommended Operating Conditions*. Exposure to absolute-maximum-rated conditions for extended periods may affect device reliability.
- (2) Voltage values are with respect to the anode terminal, unless otherwise noted.

### 6.2 ESD Ratings

			VALUE	UNIT
$V_{(ESD)}$	Electrostatic discharge	Human body model (HBM), per ANSI/ESDA/JEDEC JS-001 <sup>(1)</sup>	±2000	V
		Charged device model (CDM), per JEDEC specification JESD22-C101 <sup>(2)</sup>	±1000	

- (1) JEDEC document JEP155 states that 500-V HBM allows safe manufacturing with a standard ESD control process.
- (2) JEDEC document JEP157 states that 250-V CDM allows safe manufacturing with a standard ESD control process.

### 6.3 Recommended Operating Conditions

See<sup>(1)</sup>

			MIN	MAX	UNIT
$V_{KA}$	Cathode voltage		$V_{REF}$	18	V
$I_K$	Cathode current (continuous)		0.1	70	mA
$T_A$	Operating free-air temperature	TLVH43x_C	0	70	°C
		TLVH43x_I	-40	85	
		TLVH43x_Q	-40	125	

- (1) Maximum power dissipation is a function of  $T_J(max)$ ,  $\theta_{JA}$ , and  $T_A$ . The maximum allowable power dissipation at any allowable ambient temperature is  $P_D = (T_J(max) - T_A) / \theta_{JA}$ . Operating at the absolute maximum  $T_J$  of 150°C can affect reliability.

### 6.4 Thermal Information

THERMAL METRIC <sup>(1)</sup>		TLVH43xx					UNIT
		DCK (SC70)	PK (SOT-89)	DBV (SOT-23)	DBZ (SOT-23)	LP (TO-92)	
		6 PINS	3 PINS	5 PINS	3 PINS	3 PINS	
$R_{\theta JA}$	Junction-to-ambient thermal resistance	87	52	206	206	140	°C/W
$R_{\theta JC(top)}$	Junction-to-case (top) thermal resistance	259	9	131	76	55	°C/W

- (1) For more information about traditional and new thermal metrics, see the [Semiconductor and IC Package Thermal Metrics](#) application report.

## 6.5 TLVH43x Electrical Characteristics

at 25°C free-air temperature (unless otherwise noted)

PARAMETER	TEST CONDITIONS		TLVH431 TLVH432			UNIT
			MIN	TYP	MAX	
V <sub>REF</sub> Reference voltage	V <sub>K<sub>A</sub></sub> = V <sub>REF</sub> , I <sub>K</sub> = 10 mA	T <sub>A</sub> = 25°C	1.222	1.24	1.258	V
		T <sub>A</sub> = full range, See Figure 18 <sup>(1)</sup>	TLVH431C	1.21	1.27	
			TLVH431I	1.202	1.278	
V <sub>REF(dev)</sub> V <sub>REF</sub> deviation over full temperature range <sup>(2)</sup>	V <sub>K<sub>A</sub></sub> = V <sub>REF</sub> , I <sub>K</sub> = 10 mA, See Figure 18 <sup>(1)</sup>	TLVH431C		4	12	mV
		TLVH431I		6	20	
		TLVH431Q		11	31	
$\frac{\Delta V_{REF}}{\Delta V_{KA}}$ Ratio of V <sub>REF</sub> change to cathode voltage change	I <sub>K</sub> = 10 mA, V <sub>K</sub> = V <sub>REF</sub> to 18 V, See Figure 19			-1.5	-2.7	mV/V
I <sub>ref</sub> Reference terminal current	I <sub>K</sub> = 10 mA, R1 = 10 kΩ, R2 = open, See Figure 19			0.1	0.5	μA
I <sub>ref(dev)</sub> I <sub>ref</sub> deviation over full temperature range <sup>(2)</sup>	I <sub>K</sub> = 10 mA, R1 = 10 kΩ, R2 = open, See Figure 19 <sup>(1)</sup>	TLVH431C		0.05	0.3	μA
		TLVH431I		0.1	0.4	
		TLVH431Q		0.15	0.5	
I <sub>K(min)</sub> Minimum cathode current for regulation	V <sub>K<sub>A</sub></sub> = V <sub>REF</sub> , See Figure 18			60	100	μA
I <sub>K(off)</sub> Off-state cathode current	V <sub>REF</sub> = 0, V <sub>K<sub>A</sub></sub> = 18 V, See Figure 20			0.02	0.1	μA
z <sub>KA</sub>   Dynamic impedance <sup>(3)</sup>	V <sub>K<sub>A</sub></sub> = V <sub>REF</sub> , f ≤ 1 kHz, I <sub>K</sub> = 0.1 mA to 70 mA, See Figure 18			0.25	0.4	Ω

(1) Full temperature ranges are -40°C to +125°C for TLVH431Q, -40°C to +85°C for TLVH431I, and 0°C to 70°C for TLVH431C.

(2) The deviation parameters V<sub>REF(dev)</sub> and I<sub>ref(dev)</sub> are defined as the differences between the maximum and minimum values obtained over the rated temperature range. The average full-range temperature coefficient of the reference input voltage, αV<sub>REF</sub>, is defined as:

$$|\alpha V_{REF}| \left( \frac{\text{ppm}}{^{\circ}\text{C}} \right) = \frac{\left( \frac{V_{REF(dev)}}{V_{REF}(T_A = 25^{\circ}\text{C})} \right) \times 10^6}{\Delta T_A}$$

where ΔT<sub>A</sub> is the rated operating free-air temperature range of the device.

αV<sub>REF</sub> can be positive or negative, depending on whether minimum V<sub>REF</sub> or maximum V<sub>REF</sub>, respectively, occurs at the lower temperature.

(3) The dynamic impedance is defined as:

$$|z_{ka}| = \frac{\Delta V_{KA}}{\Delta I_K}$$

When the device is operating with two external resistors (see Figure 19), the total dynamic impedance of the circuit is defined as:

$$|z_{ka}'| = \frac{\Delta V}{\Delta I} \approx |z_{ka}| \times \left( 1 + \frac{R1}{R2} \right)$$

## 6.6 TLVH43xA Electrical Characteristics

at 25°C free-air temperature (unless otherwise noted)

PARAMETER	TEST CONDITIONS		TLVH431A TLVH432A			UNIT	
			MIN	TYP	MAX		
V <sub>REF</sub> Reference voltage	V <sub>KA</sub> = V <sub>REF</sub> , I <sub>K</sub> = 10 mA	T <sub>A</sub> = 25°C	1.228	1.24	1.252	V	
		T <sub>A</sub> = full range, See Figure 18 <sup>(1)</sup>	TLVH431AC	1.221	1.259		
			TLVH431AI	1.215	1.265		
V <sub>REF(dev)</sub> V <sub>REF</sub> deviation over full temperature range <sup>(2)</sup>	V <sub>KA</sub> = V <sub>REF</sub> , I <sub>K</sub> = 10 mA, See Figure 18 <sup>(1)</sup>	TLVH431AC		4	12	mV	
		TLVH431AI		6	20		
		TLVH431AQ		11	31		
$\frac{\Delta V_{REF}}{\Delta V_{KA}}$	Ratio of V <sub>REF</sub> change to cathode voltage change	V <sub>K</sub> = V <sub>REF</sub> to 18 V, I <sub>K</sub> = 10 mA, See Figure 19		-1.5	-2.7	mV/V	
I <sub>ref</sub>	Reference terminal current	I <sub>K</sub> = 10 mA, R1 = 10 kΩ, R2 = open, See Figure 19		0.1	0.5	μA	
I <sub>ref(dev)</sub>	I <sub>ref</sub> deviation over full temperature range <sup>(2)</sup>	I <sub>K</sub> = 10 mA, R1 = 10 kΩ, R2 = open, See Figure 19 <sup>(1)</sup>	TLVH431AC	0.05	0.3	μA	
			TLVH431AI		0.1		0.4
			TLVH431AQ		0.15		0.5
I <sub>K(min)</sub>	Minimum cathode current for regulation	V <sub>KA</sub> = V <sub>REF</sub> , See Figure 18		60	100	μA	
I <sub>K(off)</sub>	Off-state cathode current	V <sub>REF</sub> = 0, V <sub>KA</sub> = 18 V, See Figure 20		0.02	0.1	μA	
z <sub>KA</sub>	Dynamic impedance <sup>(3)</sup>	V <sub>KA</sub> = V <sub>REF</sub> , f ≤ 1 kHz, I <sub>K</sub> = 0.1 mA to 70 mA, See Figure 18		0.25	0.4	Ω	

(1) Full temperature ranges are -40°C to +125°C for TLVH431Q, -40°C to +85°C for TLVH431I, and 0°C to 70°C for TLVH431C.

(2) The deviation parameters V<sub>REF(dev)</sub> and I<sub>ref(dev)</sub> are defined as the differences between the maximum and minimum values obtained over the rated temperature range. The average full-range temperature coefficient of the reference input voltage, αV<sub>REF</sub>, is defined as:

$$|\alpha V_{REF}| \left( \frac{\text{ppm}}{^{\circ}\text{C}} \right) = \frac{\left( \frac{V_{REF(dev)}}{V_{REF}(T_A = 25^{\circ}\text{C})} \right) \times 10^6}{\Delta T_A}$$

where ΔT<sub>A</sub> is the rated operating free-air temperature range of the device.

αV<sub>REF</sub> can be positive or negative, depending on whether minimum V<sub>REF</sub> or maximum V<sub>REF</sub>, respectively, occurs at the lower temperature.

(3) The dynamic impedance is defined as:

$$|z_{ka}| = \frac{\Delta V_{KA}}{\Delta I_K}$$

When the device is operating with two external resistors (see Figure 19), the total dynamic impedance of the circuit is defined as:

$$|z_{ka}'| = \frac{\Delta V}{\Delta I} \approx |z_{ka}| \times \left( 1 + \frac{R1}{R2} \right)$$

## 6.7 TLVH43xB Electrical Characteristics

at 25°C free-air temperature (unless otherwise noted)

PARAMETER	TEST CONDITIONS		TLVH431B TLVH432B			UNIT
			MIN	TYP	MAX	
V <sub>REF</sub> Reference voltage	V <sub>KA</sub> = V <sub>REF</sub> , I <sub>K</sub> = 10 mA	T <sub>A</sub> = 25°C	1.234	1.24	1.246	V
		T <sub>A</sub> = full range, See Figure 18 <sup>(1)</sup>	TLVH431BC	1.227	1.253	
			TLVH431BI	1.224	1.259	
V <sub>REF(dev)</sub> V <sub>REF</sub> deviation over full temperature range <sup>(2)</sup>	V <sub>KA</sub> = V <sub>REF</sub> , I <sub>K</sub> = 10 mA, See Figure 18 <sup>(1)</sup>	TLVH431BC		4	12	mV
		TLVH431BI		6	20	
		TLVH431BQ		11	31	
$\frac{\Delta V_{REF}}{\Delta V_{KA}}$ Ratio of V <sub>REF</sub> change to cathode voltage change	I <sub>K</sub> = 10 mA, V <sub>K</sub> = V <sub>REF</sub> to 18 V, See Figure 19			-1.5	-2.7	mV/V
I <sub>ref</sub> Reference terminal current	I <sub>K</sub> = 10 mA, R1 = 10 kΩ, R2 = open, See Figure 19			0.1	0.5	μA
I <sub>ref(dev)</sub> I <sub>ref</sub> deviation over full temperature range <sup>(2)</sup>	I <sub>K</sub> = 10 mA, R1 = 10 kΩ, R2 = open, See Figure 19 <sup>(1)</sup>	TLVH431BC		0.05	0.3	μA
		TLVH431BI		0.1	0.4	
		TLVH431BQ		0.15	0.5	
I <sub>K(min)</sub> Minimum cathode current for regulation	V <sub>KA</sub> = V <sub>REF</sub> , See Figure 18			60	100	μA
I <sub>K(off)</sub> Off-state cathode current	V <sub>REF</sub> = 0, V <sub>KA</sub> = 18 V, See Figure 20			0.02	0.1	μA
z <sub>KA</sub>   Dynamic impedance <sup>(3)</sup>	V <sub>KA</sub> = V <sub>REF</sub> , f ≤ 1 kHz, I <sub>K</sub> = 0.1 mA to 70 mA, See Figure 18			0.25	0.4	Ω

(1) Full temperature ranges are -40°C to +125°C for TLVH431Q, -40°C to +85°C for TLVH431I, and 0°C to 70°C for TLVH431C.

(2) The deviation parameters V<sub>REF(dev)</sub> and I<sub>ref(dev)</sub> are defined as the differences between the maximum and minimum values obtained over the rated temperature range. The average full-range temperature coefficient of the reference input voltage, αV<sub>REF</sub>, is defined as:

$$|\alpha V_{REF}| \left( \frac{\text{ppm}}{^{\circ}\text{C}} \right) = \frac{\left( \frac{V_{REF(dev)}}{V_{REF}(T_A = 25^{\circ}\text{C})} \right) \times 10^6}{\Delta T_A}$$

where ΔT<sub>A</sub> is the rated operating free-air temperature range of the device.

αV<sub>REF</sub> can be positive or negative, depending on whether minimum V<sub>REF</sub> or maximum V<sub>REF</sub>, respectively, occurs at the lower temperature.

(3) The dynamic impedance is defined as:

$$|z_{ka}| = \frac{\Delta V_{KA}}{\Delta I_K}$$

When the device is operating with two external resistors (see Figure 19), the total dynamic impedance of the circuit is defined as:

$$|z_{ka}|' = \frac{\Delta V}{\Delta I} \approx |z_{ka}| \times \left( 1 + \frac{R1}{R2} \right)$$

## 6.8 Typical Characteristics

Operation of the device at these or any other conditions beyond those indicated in the *Recommended Operating Conditions* table are not implied.



**Figure 1. Reference Voltage vs Junction Temperature**



**Figure 2. Reference Input Current vs Junction Temperature**



**Figure 3. Cathode Current vs Cathode Voltage**



**Figure 4. Cathode Current vs Cathode Voltage**

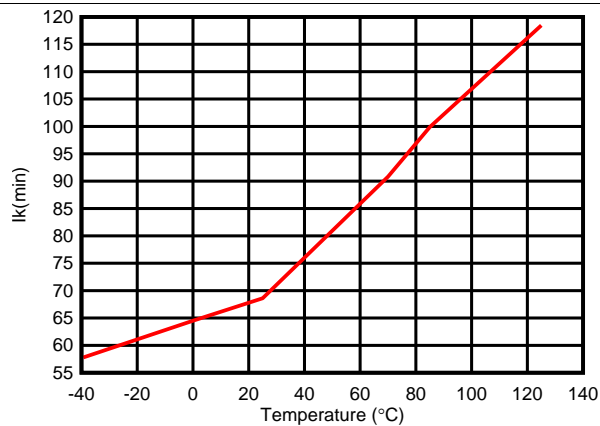

**Figure 5. Minimum Cathode Current vs. Temperature**

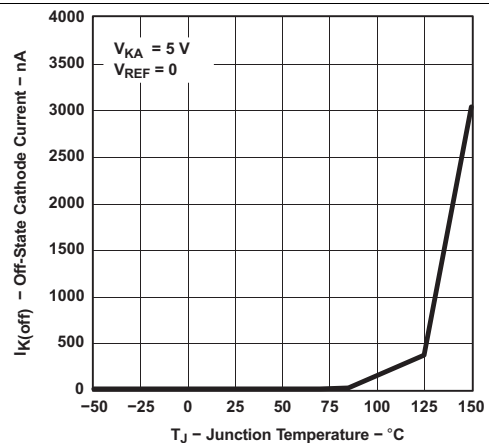

**Figure 6. Off-State Cathode Current vs Junction Temperature**

### Typical Characteristics (continued)

Operation of the device at these or any other conditions beyond those indicated in the [Recommended Operating Conditions](#) table are not implied.

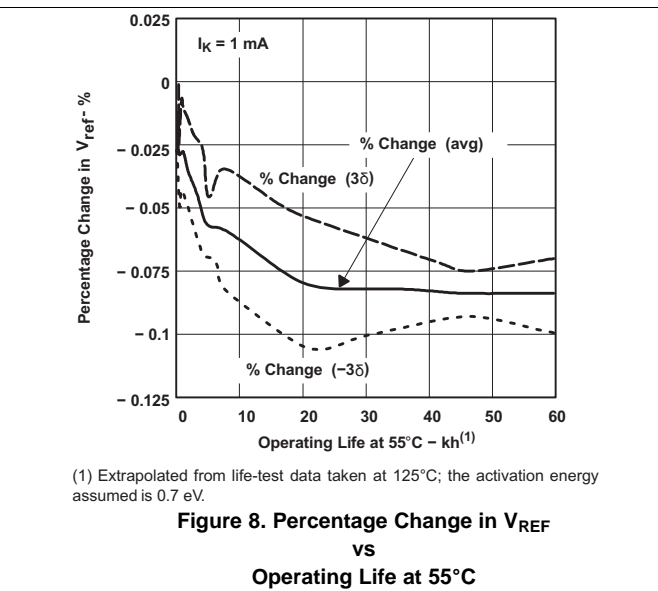
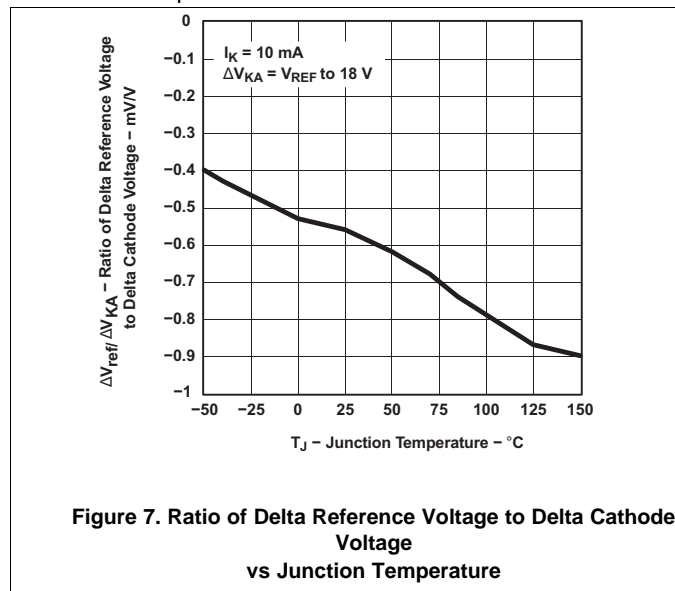

### EQUIVALENT INPUT NOISE VOLTAGE vs FREQUENCY

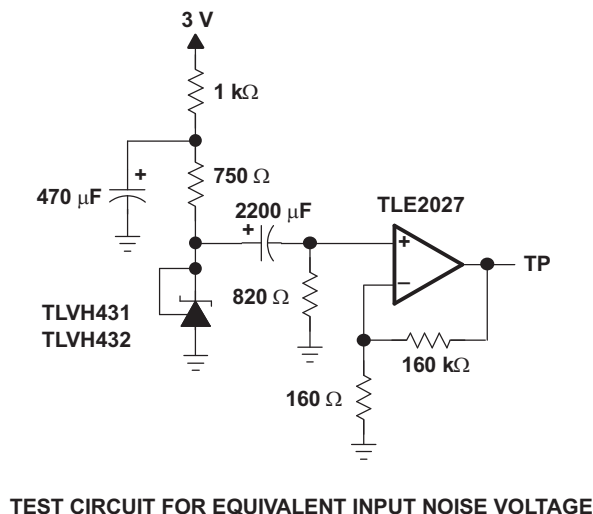
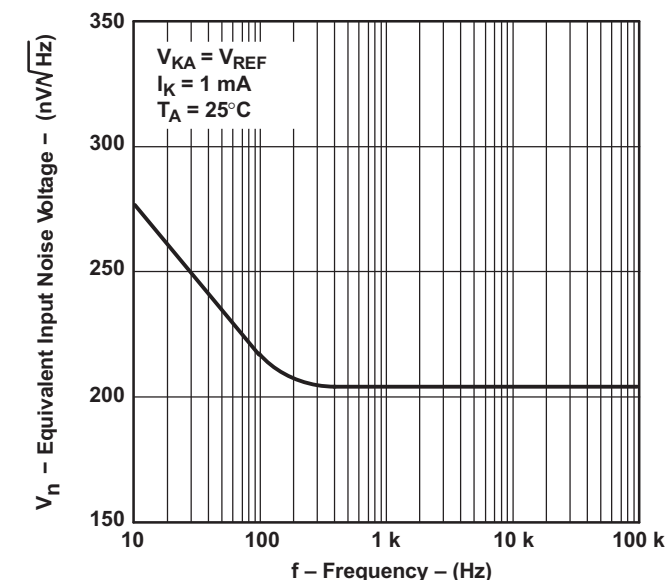

Figure 9. Equivalent Input Noise Voltage

## Typical Characteristics (continued)

Operation of the device at these or any other conditions beyond those indicated in the [Recommended Operating Conditions](#) table are not implied.

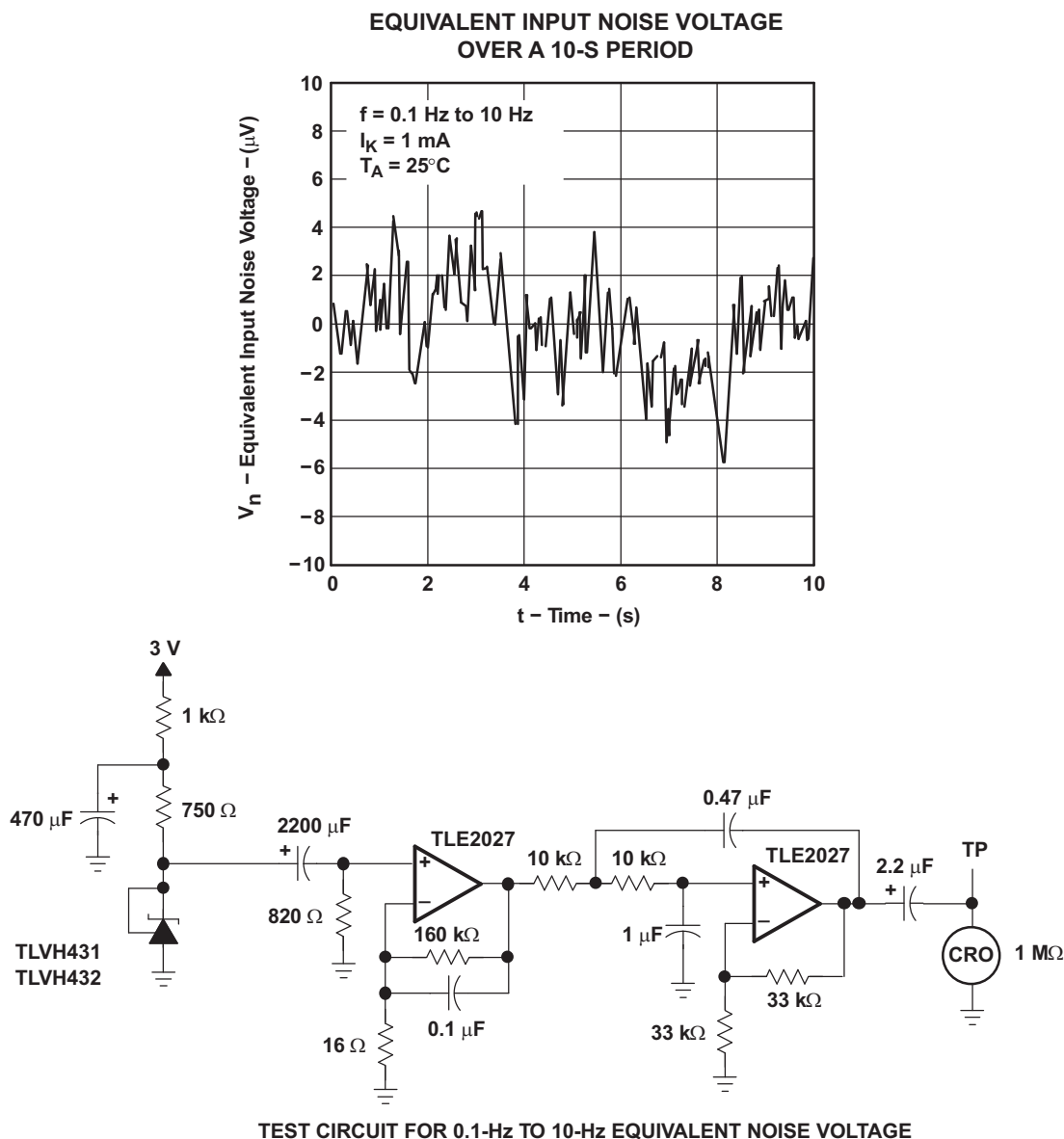

Figure 10. Equivalent Input Noise Voltage

### Typical Characteristics (continued)

Operation of the device at these or any other conditions beyond those indicated in the [Recommended Operating Conditions](#) table are not implied.



Figure 11. Voltage Gain and Phase Margin

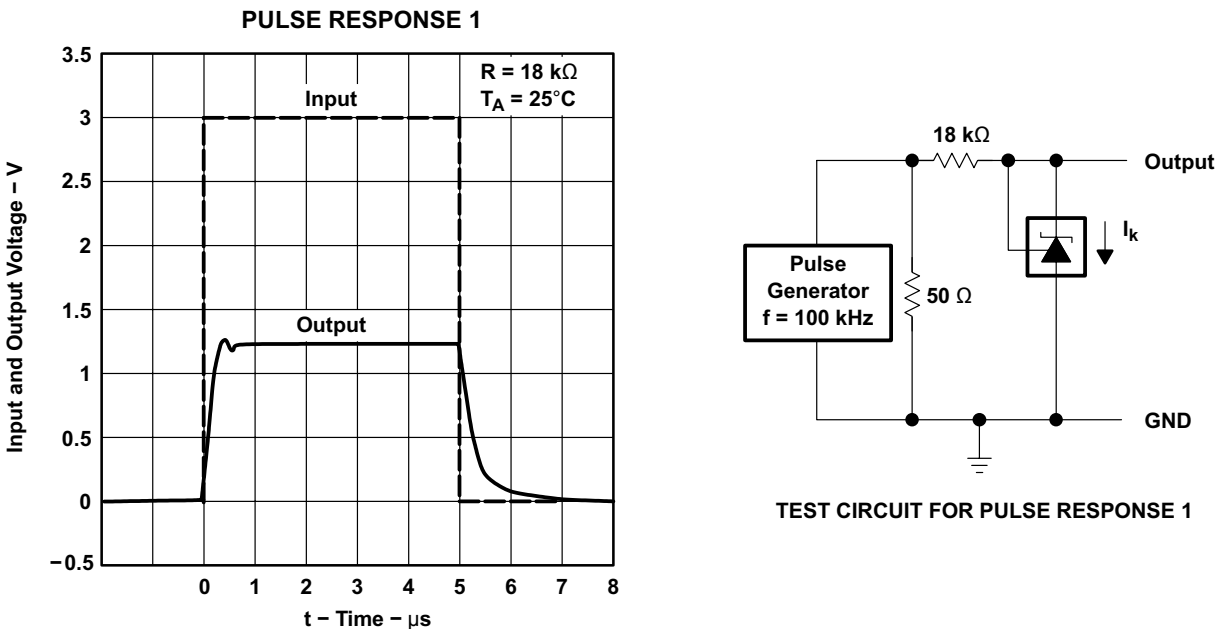

Figure 12. Pulse Response 1

### Typical Characteristics (continued)

Operation of the device at these or any other conditions beyond those indicated in the [Recommended Operating Conditions](#) table are not implied.

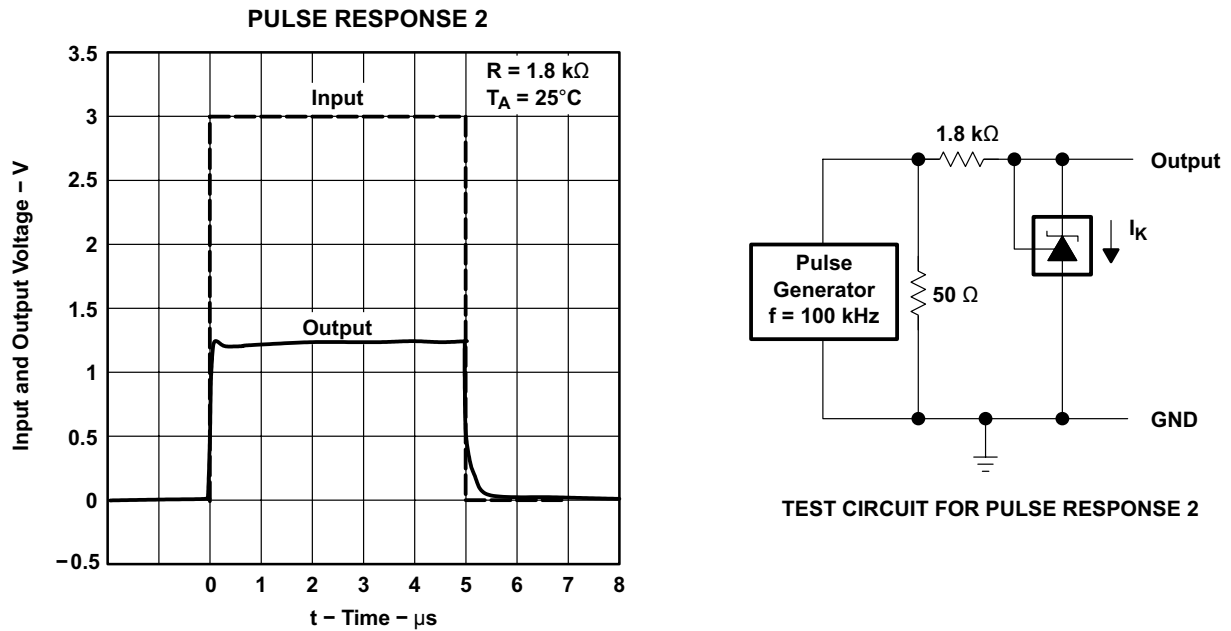

Figure 13. Pulse Response 2



Figure 14. Phase Margin Test Circuit

### Typical Characteristics (continued)

Operation of the device at these or any other conditions beyond those indicated in the *Recommended Operating Conditions* table are not implied.

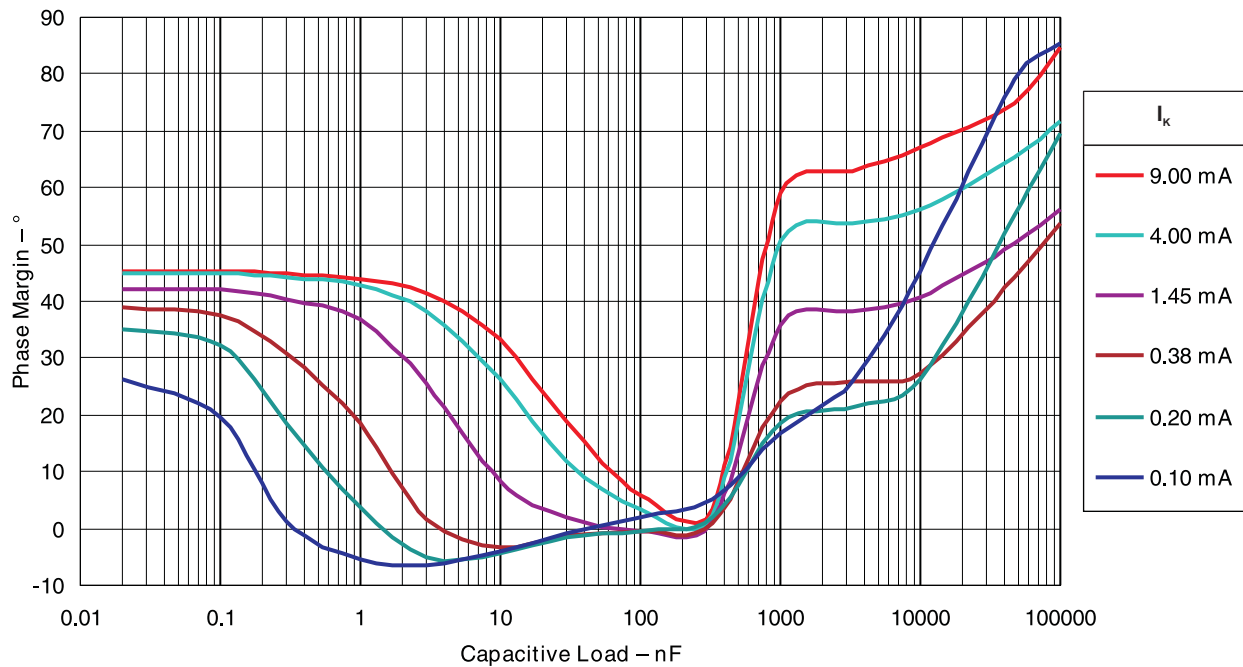

**Figure 15. Phase Margin vs Capacitive Load**  
 $V_{KA} = V_{REF} (1.25 V), T_A = 25^\circ C$

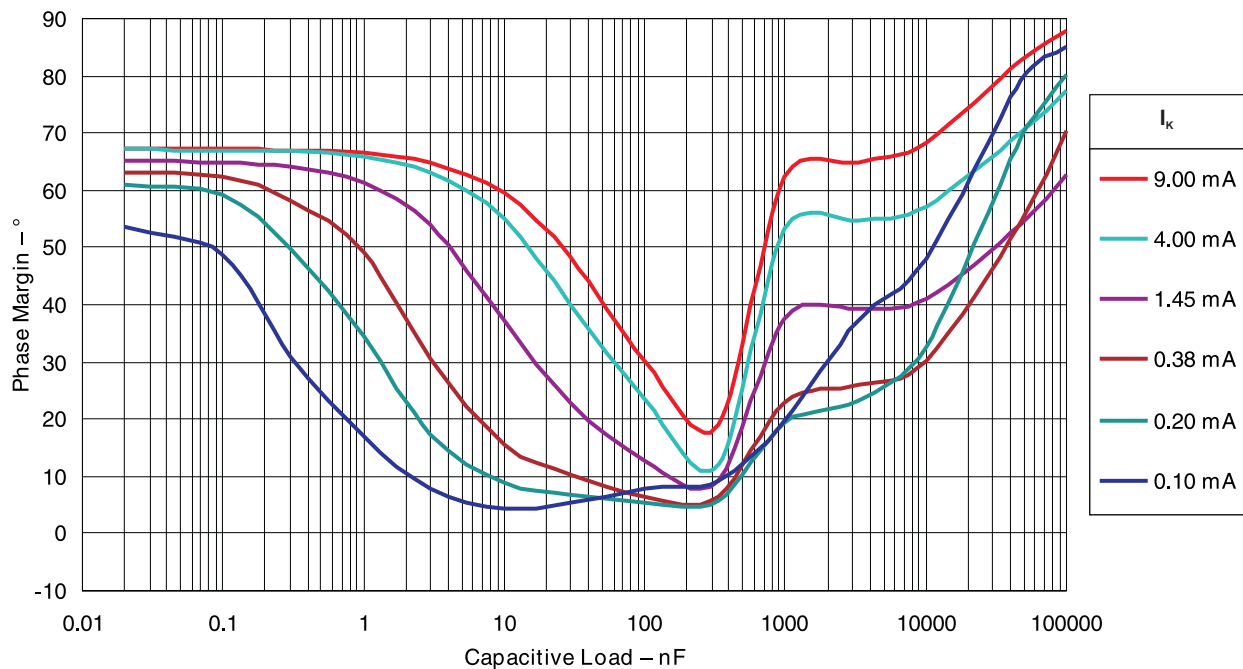

**Figure 16. Phase Margin vs Capacitive Load**  
 $V_{KA} = 2.50 V, T_A = 25^\circ C$

### Typical Characteristics (continued)

Operation of the device at these or any other conditions beyond those indicated in the *Recommended Operating Conditions* table are not implied.

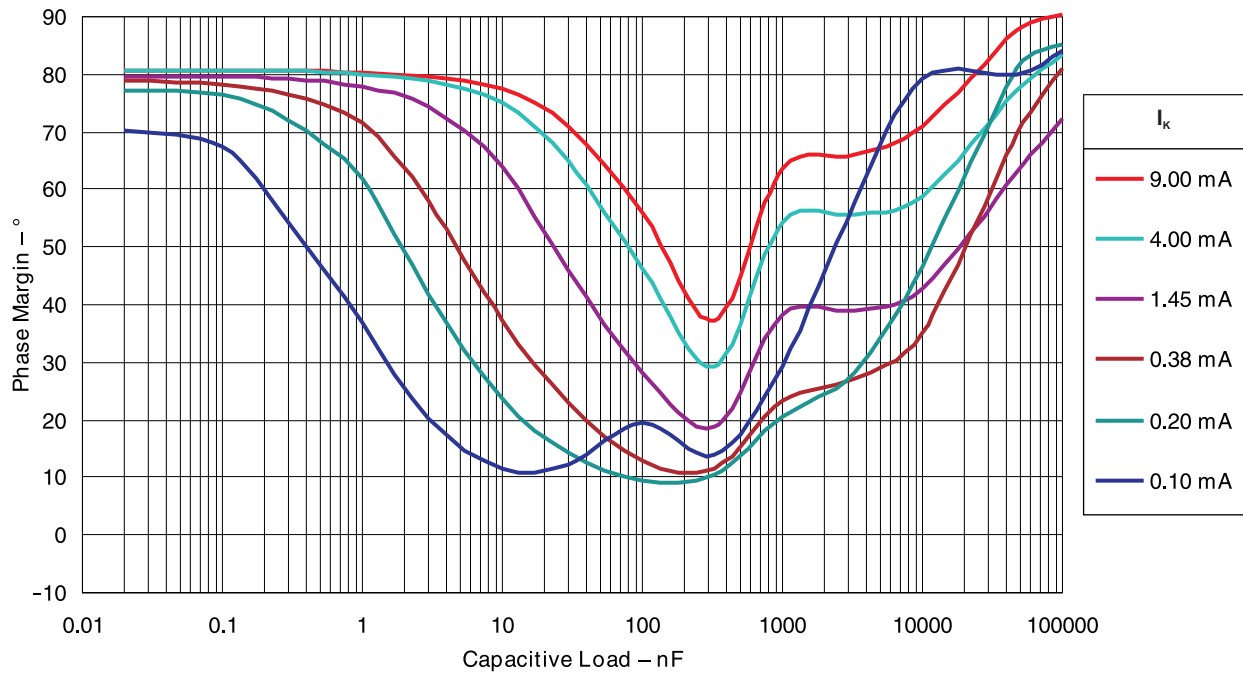

**Figure 17. Phase Margin vs Capacitive Load**  
 $V_{KA} = 5.00 \text{ V}$ ,  $T_A = 25^\circ\text{C}$

## 7 Parameter Measurement Information



Figure 18. Test Circuit for  $V_{KA} = V_{REF}$ ,  $V_O = V_{KA} = V_{REF}$



Figure 19. Test Circuit for  $V_{KA} > V_{REF}$ ,  $V_O = V_{KA} = V_{REF} \times (1 + R1/R2) + I_{ref} \times R1$



Figure 20. Test Circuit for  $I_{K(off)}$

## 8 Detailed Description

### 8.1 Overview

TLVH431 is a low power counterpart to TL431, having lower reference voltage (1.24 V versus 2.5 V) for lower voltage adjustability and lower minimum cathode current ( $I_{k(\min)} = 100 \mu\text{A}$  versus 1 mA). Like TL431, TLVH431 is used in conjunction with its key components to behave as a single voltage reference, error amplifier, voltage clamp or comparator with integrated reference.

TLVH431 is also a higher voltage counterpart to TLV431, with cathode voltage adjustability from 1.24 V to 18 V, making this part optimum for a wide range of end equipments in industrial, auto, telecom and computing. In order for this device to behave as a shunt regulator or error amplifier,  $>100 \mu\text{A}$  ( $I_{\min(\max)}$ ) must be supplied in to the cathode pin. Under this condition, feedback can be applied from the Cathode and Ref pins to create a replica of the internal reference voltage.

Various reference voltage options can be purchased with initial tolerances (at 25°C) of 0.5%, 1%, and 1.5%. These reference options are denoted by B (0.5%), A (1.0%) and blank (1.5%) after the TLVH431.

The TLVH431xC devices are characterized for operation from 0°C to 70°C, the TLVH431xI devices are characterized for operation from -40°C to +85°C, and the TLVH431xQ devices are characterized for operation from -40°C to +125°C.

### 8.2 Functional Block Diagram



Figure 21. Equivalent Schematic

## Functional Block Diagram (continued)



Figure 22. Detailed Schematic

### 8.3 Feature Description

TLVH431 consists of an internal reference and amplifier that outputs a sink current base on the difference between the reference pin and the virtual internal pin. The sink current is produced by an internal Darlington pair.

When operated with enough voltage headroom ( $\geq 1.24$  V) and cathode current ( $I_{ka}$ ), TLVH431 forces the reference pin to 1.24 V. However, the reference pin can not be left floating, as it needs  $I_{ref} \geq 0.5$   $\mu$ A (see [Specifications](#)). This is because the reference pin is driven into an NPN, which needs base current in order operate properly.

When feedback is applied from the Cathode and Reference pins, TLVH431 behaves as a Zener diode, regulating to a constant voltage dependent on current being supplied into the cathode. This is due to the internal amplifier and reference entering the proper operating regions. The same amount of current needed in the above feedback situation must be applied to this device in open loop, servo or error amplifying implementations in order for it to be in the proper linear region giving TLVH431 enough gain.

Unlike many linear regulators, TLVH431 is internally compensated to be stable without an output capacitor between the cathode and anode. However, if it is desired to use an output capacitor [Figure 15](#), [Figure 16](#), and [Figure 17](#) can be used as a guide to assist in choosing the correct capacitor to maintain stability.

## 8.4 Device Functional Modes

### 8.4.1 Open Loop (Comparator)

When the cathode/output voltage or current of TLVH431 is not being fed back to the reference/input pin in any form, this device is operating in open loop. With proper cathode current ( $I_{ka}$ ) applied to this device, TLVH431 has the characteristics shown in [Figure 4](#). With such high gain in this configuration, the TLVH431 device is typically used as a comparator. With the reference integrated makes TLVH431 the preferred choice when users are trying to monitor a certain level of a single signal.

### 8.4.2 Closed Loop

When the cathode/output voltage or current of TLVH431 is being fed back to the reference/input pin in any form, this device is operating in closed loop. The majority of applications involving TLVH431 use it in this manner to regulate a fixed voltage or current. The feedback enables this device to behave as an error amplifier, computing a portion of the output voltage and adjusting it to maintain the desired regulation. This is done by relating the output voltage back to the reference pin in a manner to make it equal to the internal reference voltage, which can be accomplished through resistive or direct feedback.

## 9 Applications and Implementation

### NOTE

Information in the following applications sections is not part of the TI component specification, and TI does not warrant its accuracy or completeness. TI's customers are responsible for determining suitability of components for their purposes. Customers should validate and test their design implementation to confirm system functionality.

### 9.1 Application Information

Figure 23 shows the TLVH431, TLVH431A, or TLVH431B used in a 3.3-V isolated flyback supply. Output voltage  $V_O$  can be as low as reference voltage  $V_{REF}$  ( $1.24\text{ V} \pm 1\%$ ). The output of the regulator, plus the forward voltage drop of the optocoupler LED ( $1.24 + 1.4 = 2.64\text{ V}$ ), determine the minimum voltage that can be regulated in an isolated supply configuration. Regulated voltage as low as 2.7 Vdc is possible in the topology shown in Figure 23.

The TLVH431 family of devices are prevalent in these applications, being designers go to choice for secondary side regulation. Due to this prevalence, this section explains operation and design in both states of TLVH431 that this application will see, open loop (Comparator +  $V_{REF}$ ) and closed loop (Shunt Regulator).

Further information about system stability and using a TLVH431 device for compensation see *Compensation Design With TL431 for UCC28600*, [SLUA671](#).



Figure 23. Flyback With Isolation Using TLVH431 or TLVH432 as Voltage Reference and Error Amplifier

## 9.2 Typical Applications

### 9.2.1 Comparator With Integrated Reference (Open Loop)



Figure 24. Comparator Application Schematic

#### 9.2.1.1 Design Requirements

For this design example, use the parameters listed in [Table 1](#) as the input parameters.

Table 1. Design Parameters

DESIGN PARAMETER	EXAMPLE VALUE
Input Voltage Range	0 V to 5 V
Input Resistance	10 k $\Omega$
Supply Voltage	9 V
Cathode Current ( $I_k$ )	500 $\mu$ A
Output Voltage Level	$\sim 1 \text{ V} - V_{\text{sup}}$
Logic Input Thresholds $V_{IH}/V_{IL}$	$V_L$

#### 9.2.1.2 Detailed Design Procedure

When using TLVH431 as a comparator with reference, determine the following:

- Input voltage range
- Reference voltage accuracy
- Output logic input high and low level thresholds
- Current source resistance

##### 9.2.1.2.1 Basic Operation

In the configuration shown in [Figure 24](#), TLVH431 behaves as a comparator, comparing the  $V_{\text{ref}}$  pin voltage to the internal virtual reference voltage. When provided a proper cathode current ( $I_k$ ), TLVH431 will have enough open loop gain to provide a quick response. With the TLVH431's max Operating Current ( $I_{\text{min}}$ ) being 100  $\mu$ A and up to 150  $\mu$ A over temperature, operation below that could result in low gain, leading to a slow response.

### 9.2.1.2.2 Overdrive

Slow or inaccurate responses can also occur when the reference pin is not provided enough overdrive voltage. This is the amount of voltage that is higher than the internal virtual reference. The internal virtual reference voltage will be within the range of 1.24 V  $\pm$ (0.5%, 1.0% or 1.5%) depending on which version is being used.

The more overdrive voltage provided, the faster the TLVH431 will respond. See figures [Figure 25](#) and [Figure 26](#), for the output responses to various input voltages.

For applications where TLVH431 is being used as a comparator, it is best to set the trip point to greater than the positive expected error (that is, +1.0% for the A version). For fast response, setting the trip point to > 10% of the internal  $V_{ref}$  should suffice.

For minimal voltage drop or difference from  $V_{in}$  to the ref pin, it is recommended to use an input resistor <10 k $\Omega$  to provide  $I_{ref}$ .

### 9.2.1.2.3 Output Voltage and Logic Input Level

In order for TLVH431 to properly be used as a comparator, the logic output must be readable by the receiving logic device. This is accomplished by knowing the input high and low level threshold voltage levels, typically denoted by  $V_{IH}$  and  $V_{IL}$ .

As shown in [Figure 25](#) and [Figure 26](#), TLVH431's output low level voltage in open-loop/comparator mode is approximately 1 V, which is sufficient for some 3.3 V supplied logic. However, would not work for 2.5 V and 1.8 V supplied logic. To accommodate this a resistive divider can be tied to the output to attenuate the output voltage to a voltage legible to the receiving low voltage logic device.

TLVH431's output high voltage is approximately  $V_{SUP}$  due to TLVH431 being open-collector. If  $V_{SUP}$  is much higher than the receiving logic's maximum input voltage tolerance, the output must be attenuated to accommodate the outgoing logic's reliability.

When using a resistive divider on the output, be sure to make the sum of the resistive divider ( $R_1$  and  $R_2$  in [Figure 24](#)) is much greater than  $R_{SUP}$  in order to not interfere with TLVH431's ability to pull close to  $V_{SUP}$  when turning off.

#### 9.2.1.2.3.1 Input Resistance

TLVH431 requires an input resistance in this application in order to source the reference current ( $I_{REF}$ ) needed from this device to be in the proper operating regions while turning on. The actual voltage seen at the ref pin will be  $V_{REF} = V_{IN} - I_{REF} \times R_{IN}$ . Because  $I_{REF}$  can be as high as 0.5  $\mu$ A, TI recommends to use a resistance small enough that will mitigate the error that  $I_{REF}$  creates from  $V_{IN}$ .

### 9.2.1.3 Application Curves

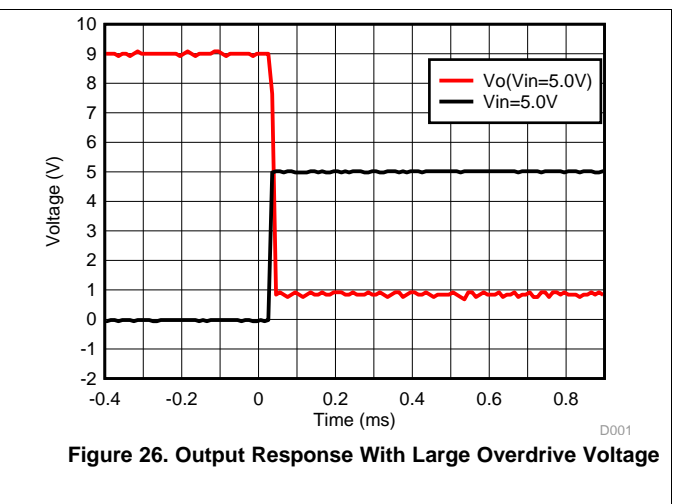
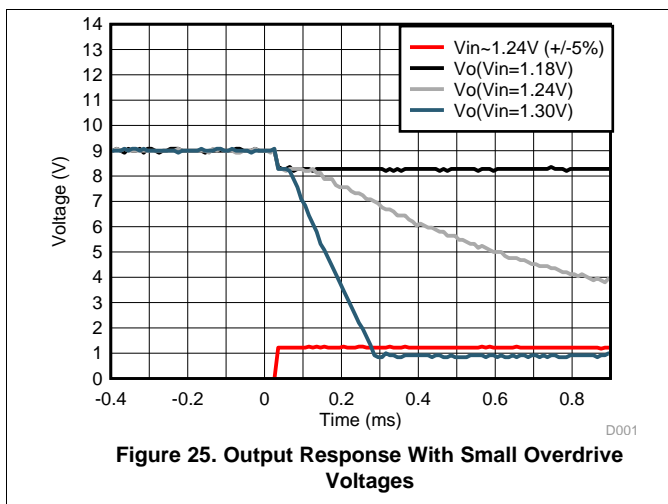

## 9.2.2 Shunt Regulator/Reference



Copyright © 2016, Texas Instruments Incorporated

**Figure 27. Shunt Regulator Schematic**

### 9.2.2.1 Design Requirements

For this design example, use the parameters listed in [Table 2](#) as the input parameters.

**Table 2. Design Parameters**

DESIGN PARAMETER	EXAMPLE VALUE
Reference Initial Accuracy	1.0%
Supply Voltage	6 V
Cathode Current (I <sub>k</sub> )	500 μA
Output Voltage Level	1.24 V - 18 V
Load Capacitance	100 nF
Feedback Resistor Values and Accuracy (R1 and R2)	10 kΩ

### 9.2.2.2 Detailed Design Procedure

When using TLVH431 as a Shunt Regulator, determine the following:

- Input voltage range
- Temperature range
- Total accuracy
- Cathode current
- Reference initial accuracy
- Output capacitance

#### 9.2.2.2.1 Programming Output/Cathode Voltage

To program the cathode voltage to a regulated voltage a resistive bridge must be shunted between the cathode and anode pins with the mid point tied to the reference pin. This can be seen in [Figure 27](#), with R1 and R2 being the resistive bridge. The cathode/output voltage in the shunt regulator configuration can be approximated by the equation shown in [Figure 27](#). The cathode voltage can be more accurately determined by taking in to account the cathode current:

$$V_O = (1 + R1/R2) \times V_{REF} - I_{REF} \times R1$$

In order for this equation to be valid, TLVH431 must be fully biased so that it has enough open loop gain to mitigate any gain error. This can be done by meeting the I<sub>min</sub> spec denoted in [Specifications](#).

### 9.2.2.2.2 Total Accuracy

When programming the output above unity gain ( $V_{KA}=V_{REF}$ ), TLVH431 is susceptible to other errors that may effect the overall accuracy beyond  $V_{REF}$ . These errors include:

- R1 and R2 accuracies
- $V_{I(dev)}$  - Change in reference voltage over temperature
- $\Delta V_{ref} / \Delta V_{KA}$  - Change in reference voltage to the change in cathode voltage
- $|z_{KA}|$  - Dynamic impedance, causing a change in cathode voltage with cathode current

Worst case, cathode voltage can be determined taking all of the variables in to account. The application note *Setting the Shunt Voltage on an Adjustable Shunt Regulator*, [SLVA445](#), assists designers in setting the shunt voltage to achieve optimum accuracy for this device.

### 9.2.2.2.3 Stability

Though TLVH431 is stable with no capacitive load, the device that receives the shunt regulator's output voltage could present a capacitive load that is within the TLVH431 region of stability, shown in [Figure 15](#), [Figure 16](#) and [Figure 17](#). Also, designers may use capacitive loads to improve the transient response or for power supply decoupling.

TI recommends to choose capacitors that will give a phase margin  $> 5^\circ$  to guarantee stability of the TLVH431.

### 9.2.2.3 Application Curve



Figure 28. TLVH431 Start-up Response

## 10 Power Supply Recommendations

When using TLVH431 as a Linear Regulator to supply a load, designers will typically use a bypass capacitor on the output/cathode pin. When doing this, be sure that the capacitance is within the stability criteria shown in [Figure 15](#), [Figure 16](#), and [Figure 17](#).

To not exceed the maximum cathode current, be sure that the supply voltage is current limited. Also, limit the current being driven into the Ref pin, as not to exceed its absolute maximum rating.

For applications shunting high currents, pay attention to the cathode and anode trace lengths, adjusting the width of the traces to have the proper current density.

## 11 Layout

### 11.1 Layout Guidelines

Place decoupling capacitors as close to the device as possible. Use appropriate widths for traces when shunting high currents to avoid excessive voltage drops.

### 11.2 Layout Example



Figure 29. DBZ Layout example

## 12 Device and Documentation Support

### 12.1 Documentation Support

#### 12.1.1 Related Documentation

For related documentation see the following:

- *Compensation Design With TL431 for UCC28600*, [SLUA671](#)
- *Setting the Shunt Voltage on an Adjustable Shunt Regulator*, [SLVA445](#)

### 12.2 Receiving Notification of Documentation Updates

To receive notification of documentation updates, navigate to the device product folder on ti.com. In the upper right corner, click on *Alert me* to register and receive a weekly digest of any product information that has changed. For change details, review the revision history included in any revised document.

### 12.3 Community Resources

The following links connect to TI community resources. Linked contents are provided "AS IS" by the respective contributors. They do not constitute TI specifications and do not necessarily reflect TI's views; see TI's [Terms of Use](#).

**TI E2E™ Online Community** *TI's Engineer-to-Engineer (E2E) Community*. Created to foster collaboration among engineers. At [e2e.ti.com](http://e2e.ti.com), you can ask questions, share knowledge, explore ideas and help solve problems with fellow engineers.

**Design Support** *TI's Design Support* Quickly find helpful E2E forums along with design support tools and contact information for technical support.

### 12.4 Related Links

The table below lists quick access links. Categories include technical documents, support and community resources, tools and software, and quick access to sample or buy.

**Table 3. Related Links**

PARTS	PRODUCT FOLDER	SAMPLE & BUY	TECHNICAL DOCUMENTS	TOOLS & SOFTWARE	SUPPORT & COMMUNITY
TLVH431	<a href="#">Click here</a>	<a href="#">Click here</a>	<a href="#">Click here</a>	<a href="#">Click here</a>	<a href="#">Click here</a>
TLVH431A	<a href="#">Click here</a>	<a href="#">Click here</a>	<a href="#">Click here</a>	<a href="#">Click here</a>	<a href="#">Click here</a>
TLVH431B	<a href="#">Click here</a>	<a href="#">Click here</a>	<a href="#">Click here</a>	<a href="#">Click here</a>	<a href="#">Click here</a>
TLVH432	<a href="#">Click here</a>	<a href="#">Click here</a>	<a href="#">Click here</a>	<a href="#">Click here</a>	<a href="#">Click here</a>
TLVH432A	<a href="#">Click here</a>	<a href="#">Click here</a>	<a href="#">Click here</a>	<a href="#">Click here</a>	<a href="#">Click here</a>
TLVH432B	<a href="#">Click here</a>	<a href="#">Click here</a>	<a href="#">Click here</a>	<a href="#">Click here</a>	<a href="#">Click here</a>

### 12.5 Trademarks

E2E is a trademark of Texas Instruments.

All other trademarks are the property of their respective owners.

### 12.6 Electrostatic Discharge Caution



These devices have limited built-in ESD protection. The leads should be shorted together or the device placed in conductive foam during storage or handling to prevent electrostatic damage to the MOS gates.

### 12.7 Glossary

[SLYZ022](#) — *TI Glossary*.

This glossary lists and explains terms, acronyms, and definitions.

## 13 Mechanical, Packaging, and Orderable Information

The following pages include mechanical packaging and orderable information. This information is the most current data available for the designated devices. This data is subject to change without notice and revision of this document. For browser based versions of this data sheet, refer to the left hand navigation.

**PACKAGING INFORMATION**

Orderable Device	Status (1)	Package Type	Package Drawing	Pins	Package Qty	Eco Plan (2)	Lead/Ball Finish (6)	MSL Peak Temp (3)	Op Temp (°C)	Device Marking (4/5)	Samples
TLVH431ACDBVR	ACTIVE	SOT-23	DBV	5	3000	Green (RoHS & no Sb/Br)	CU NIPDAU   CU SN	Level-1-260C-UNLIM	0 to 70	(Y3PG, Y3PU)	<a href="#">Samples</a>
TLVH431ACDBVRG4	ACTIVE	SOT-23	DBV	5	3000	Green (RoHS & no Sb/Br)	CU NIPDAU	Level-1-260C-UNLIM	0 to 70	Y3PG	<a href="#">Samples</a>
TLVH431ACDBVT	ACTIVE	SOT-23	DBV	5	250	Green (RoHS & no Sb/Br)	CU NIPDAU   CU SN	Level-1-260C-UNLIM	0 to 70	(Y3PG, Y3PU)	<a href="#">Samples</a>
TLVH431ACDBZR	ACTIVE	SOT-23	DBZ	3	3000	Green (RoHS & no Sb/Br)	CU NIPDAU	Level-1-260C-UNLIM	0 to 70	(Y3PS, Y3PU)	<a href="#">Samples</a>
TLVH431ACDBZRG4	ACTIVE	SOT-23	DBZ	3	3000	Green (RoHS & no Sb/Br)	CU NIPDAU	Level-1-260C-UNLIM	0 to 70	(Y3PS, Y3PU)	<a href="#">Samples</a>
TLVH431ACDBZT	ACTIVE	SOT-23	DBZ	3	250	Green (RoHS & no Sb/Br)	CU NIPDAU	Level-1-260C-UNLIM	0 to 70	(Y3PS, Y3PU)	<a href="#">Samples</a>
TLVH431ACDCKR	ACTIVE	SC70	DCK	6	3000	Green (RoHS & no Sb/Br)	CU NIPDAU	Level-1-260C-UNLIM	0 to 70	YPU	<a href="#">Samples</a>
TLVH431ACDCKRE4	ACTIVE	SC70	DCK	6	3000	Green (RoHS & no Sb/Br)	CU NIPDAU	Level-1-260C-UNLIM	0 to 70	YPU	<a href="#">Samples</a>
TLVH431ACDCKT	ACTIVE	SC70	DCK	6	250	Green (RoHS & no Sb/Br)	CU NIPDAU	Level-1-260C-UNLIM	0 to 70	YPU	<a href="#">Samples</a>
TLVH431ACDCKTG4	ACTIVE	SC70	DCK	6	250	Green (RoHS & no Sb/Br)	CU NIPDAU	Level-1-260C-UNLIM	0 to 70	YPU	<a href="#">Samples</a>
TLVH431ACLP	ACTIVE	TO-92	LP	3	1000	Pb-Free (RoHS)	CU SN	N / A for Pkg Type	0 to 70	ZA431A	<a href="#">Samples</a>
TLVH431ACLPR	ACTIVE	TO-92	LP	3	2000	Pb-Free (RoHS)	CU SN	N / A for Pkg Type	0 to 70	ZA431A	<a href="#">Samples</a>
TLVH431ACPK	ACTIVE	SOT-89	PK	3	1000	Green (RoHS & no Sb/Br)	CU SN	Level-2-260C-1 YEAR	0 to 70	W2	<a href="#">Samples</a>
TLVH431AIDBVR	ACTIVE	SOT-23	DBV	5	3000	Green (RoHS & no Sb/Br)	CU NIPDAU   CU SN	Level-1-260C-UNLIM	-40 to 85	Y3TU	<a href="#">Samples</a>
TLVH431AIDBVRE4	ACTIVE	SOT-23	DBV	5	3000	Green (RoHS & no Sb/Br)	CU SN	Level-1-260C-UNLIM	-40 to 85	Y3TU	<a href="#">Samples</a>
TLVH431AIDBVT	ACTIVE	SOT-23	DBV	5	250	Green (RoHS & no Sb/Br)	CU NIPDAU   CU SN	Level-1-260C-UNLIM	-40 to 85	Y3TU	<a href="#">Samples</a>
TLVH431AIDBVTG4	ACTIVE	SOT-23	DBV	5	250	Green (RoHS & no Sb/Br)	CU NIPDAU	Level-1-260C-UNLIM	-40 to 85	Y3TU	<a href="#">Samples</a>

Orderable Device	Status (1)	Package Type	Package Drawing	Pins	Package Qty	Eco Plan (2)	Lead/Ball Finish (6)	MSL Peak Temp (3)	Op Temp (°C)	Device Marking (4/5)	Samples
TLVH431AIDBZR	ACTIVE	SOT-23	DBZ	3	3000	Green (RoHS & no Sb/Br)	CU NIPDAU	Level-1-260C-UNLIM	-40 to 85	(Y3T3, Y3TS, Y3TU)	<a href="#">Samples</a>
TLVH431AIDBZRG4	ACTIVE	SOT-23	DBZ	3	3000	Green (RoHS & no Sb/Br)	CU NIPDAU	Level-1-260C-UNLIM	-40 to 85	(Y3T3, Y3TS, Y3TU)	<a href="#">Samples</a>
TLVH431AIDBZT	ACTIVE	SOT-23	DBZ	3	250	Green (RoHS & no Sb/Br)	CU NIPDAU	Level-1-260C-UNLIM	-40 to 85	(Y3TS, Y3TU)	<a href="#">Samples</a>
TLVH431AIDBZTG4	ACTIVE	SOT-23	DBZ	3	250	Green (RoHS & no Sb/Br)	CU NIPDAU	Level-1-260C-UNLIM	-40 to 85	(Y3TS, Y3TU)	<a href="#">Samples</a>
TLVH431AIDCKR	ACTIVE	SC70	DCK	6	3000	Green (RoHS & no Sb/Br)	CU NIPDAU	Level-1-260C-UNLIM	-40 to 85	YTU	<a href="#">Samples</a>
TLVH431AIDCKT	ACTIVE	SC70	DCK	6	250	Green (RoHS & no Sb/Br)	CU NIPDAU	Level-1-260C-UNLIM	-40 to 85	YTU	<a href="#">Samples</a>
TLVH431AILP	ACTIVE	TO-92	LP	3	1000	Pb-Free (RoHS)	CU SN	N / A for Pkg Type	-40 to 85	ZB431A	<a href="#">Samples</a>
TLVH431AILPR	ACTIVE	TO-92	LP	3	2000	Pb-Free (RoHS)	CU SN	N / A for Pkg Type	-40 to 85	ZB431A	<a href="#">Samples</a>
TLVH431AIPK	ACTIVE	SOT-89	PK	3	1000	Green (RoHS & no Sb/Br)	CU SN	Level-2-260C-1 YEAR	-40 to 85	W3	<a href="#">Samples</a>
TLVH431AIPKG3	ACTIVE	SOT-89	PK	3	1000	Green (RoHS & no Sb/Br)	CU SN	Level-2-260C-1 YEAR	-40 to 85	W3	<a href="#">Samples</a>
TLVH431AQDBVR	ACTIVE	SOT-23	DBV	5	3000	Green (RoHS & no Sb/Br)	CU NIPDAU   CU SN	Level-1-260C-UNLIM	-40 to 125	Y3NU	<a href="#">Samples</a>
TLVH431AQDBVT	ACTIVE	SOT-23	DBV	5	250	Green (RoHS & no Sb/Br)	CU NIPDAU   CU SN	Level-1-260C-UNLIM	-40 to 125	Y3NU	<a href="#">Samples</a>
TLVH431AQDBZR	ACTIVE	SOT-23	DBZ	3	3000	Green (RoHS & no Sb/Br)	CU NIPDAU	Level-1-260C-UNLIM	-40 to 125	(Y3NS, Y3NU)	<a href="#">Samples</a>
TLVH431AQDBZRG4	ACTIVE	SOT-23	DBZ	3	3000	TBD	Call TI	Call TI	-40 to 125	(Y3NS, Y3NU)	<a href="#">Samples</a>
TLVH431AQDBZT	ACTIVE	SOT-23	DBZ	3	250	Green (RoHS & no Sb/Br)	CU NIPDAU	Level-1-260C-UNLIM	-40 to 125	(Y3NS, Y3NU)	<a href="#">Samples</a>
TLVH431AQDBZTG4	ACTIVE	SOT-23	DBZ	3	250	Green (RoHS & no Sb/Br)	CU NIPDAU	Level-1-260C-UNLIM	-40 to 125	(Y3NS, Y3NU)	<a href="#">Samples</a>
TLVH431AQDCKR	ACTIVE	SC70	DCK	6	3000	Green (RoHS & no Sb/Br)	CU NIPDAU	Level-1-260C-UNLIM	-40 to 125	YNU	<a href="#">Samples</a>
TLVH431AQDCKT	ACTIVE	SC70	DCK	6	250	Green (RoHS & no Sb/Br)	CU NIPDAU	Level-1-260C-UNLIM	-40 to 125	YNU	<a href="#">Samples</a>

Orderable Device	Status (1)	Package Type	Package Drawing	Pins	Package Qty	Eco Plan (2)	Lead/Ball Finish (6)	MSL Peak Temp (3)	Op Temp (°C)	Device Marking (4/5)	Samples
TLVH431AQLP	ACTIVE	TO-92	LP	3	1000	Pb-Free (RoHS)	CU SN	N / A for Pkg Type	-40 to 125	ZD431A	<a href="#">Samples</a>
TLVH431AQLPR	ACTIVE	TO-92	LP	3	2000	Pb-Free (RoHS)	CU SN	N / A for Pkg Type	-40 to 125	ZD431A	<a href="#">Samples</a>
TLVH431AQPCK	ACTIVE	SOT-89	PK	3	1000	Green (RoHS & no Sb/Br)	CU SN	Level-2-260C-1 YEAR	-40 to 125	VD	<a href="#">Samples</a>
TLVH431AQPCKG3	ACTIVE	SOT-89	PK	3	1000	Green (RoHS & no Sb/Br)	CU SN	Level-2-260C-1 YEAR	-40 to 125	VD	<a href="#">Samples</a>
TLVH431BCDBVR	ACTIVE	SOT-23	DBV	5	3000	Green (RoHS & no Sb/Br)	CU NIPDAU   CU SN	Level-1-260C-UNLIM	0 to 70	Y3JU	<a href="#">Samples</a>
TLVH431BCDBVRG4	ACTIVE	SOT-23	DBV	5	3000	Green (RoHS & no Sb/Br)	CU NIPDAU	Level-1-260C-UNLIM	0 to 70	Y3JU	<a href="#">Samples</a>
TLVH431BCDBVT	ACTIVE	SOT-23	DBV	5	250	Green (RoHS & no Sb/Br)	CU NIPDAU   CU SN	Level-1-260C-UNLIM	0 to 70	Y3JU	<a href="#">Samples</a>
TLVH431BCDBVTE4	ACTIVE	SOT-23	DBV	5	250	Green (RoHS & no Sb/Br)	CU SN	Level-1-260C-UNLIM	0 to 70	Y3JU	<a href="#">Samples</a>
TLVH431BCDBVTG4	ACTIVE	SOT-23	DBV	5	250	Green (RoHS & no Sb/Br)	CU NIPDAU	Level-1-260C-UNLIM	0 to 70	Y3JU	<a href="#">Samples</a>
TLVH431BCDBZR	ACTIVE	SOT-23	DBZ	3	3000	Green (RoHS & no Sb/Br)	CU NIPDAU	Level-1-260C-UNLIM	0 to 70	(Y3J3, Y3JS, Y3JU)	<a href="#">Samples</a>
TLVH431BCDBZRG4	ACTIVE	SOT-23	DBZ	3	3000	Green (RoHS & no Sb/Br)	CU NIPDAU	Level-1-260C-UNLIM	0 to 70	(Y3J3, Y3JS, Y3JU)	<a href="#">Samples</a>
TLVH431BCDBZT	ACTIVE	SOT-23	DBZ	3	250	Green (RoHS & no Sb/Br)	CU NIPDAU	Level-1-260C-UNLIM	0 to 70	(Y3JS, Y3JU)	<a href="#">Samples</a>
TLVH431BCDBZTG4	ACTIVE	SOT-23	DBZ	3	250	TBD	Call TI	Call TI	0 to 70	(Y3JS, Y3JU)	<a href="#">Samples</a>
TLVH431BCDCKR	ACTIVE	SC70	DCK	6	3000	Green (RoHS & no Sb/Br)	CU NIPDAU	Level-1-260C-UNLIM	0 to 70	YHU	<a href="#">Samples</a>
TLVH431BCDCKT	ACTIVE	SC70	DCK	6	250	Green (RoHS & no Sb/Br)	CU NIPDAU	Level-1-260C-UNLIM	0 to 70	YHU	<a href="#">Samples</a>
TLVH431BCDCKTG4	ACTIVE	SC70	DCK	6	250	Green (RoHS & no Sb/Br)	CU NIPDAU	Level-1-260C-UNLIM	0 to 70	YHU	<a href="#">Samples</a>
TLVH431BCLP	ACTIVE	TO-92	LP	3	1000	Pb-Free (RoHS)	CU SN	N / A for Pkg Type	0 to 70	ZA431B	<a href="#">Samples</a>
TLVH431BCLPR	ACTIVE	TO-92	LP	3	2000	Pb-Free (RoHS)	CU SN	N / A for Pkg Type	0 to 70	ZA431B	<a href="#">Samples</a>

Orderable Device	Status (1)	Package Type	Package Drawing	Pins	Package Qty	Eco Plan (2)	Lead/Ball Finish (6)	MSL Peak Temp (3)	Op Temp (°C)	Device Marking (4/5)	Samples
TLVH431BCPK	ACTIVE	SOT-89	PK	3	1000	Green (RoHS & no Sb/Br)	CU SN	Level-2-260C-1 YEAR	0 to 70	V7	<a href="#">Samples</a>
TLVH431BIDBVR	ACTIVE	SOT-23	DBV	5	3000	Green (RoHS & no Sb/Br)	CU NIPDAU   CU SN	Level-1-260C-UNLIM	-40 to 85	Y3KU	<a href="#">Samples</a>
TLVH431BIDBVT	ACTIVE	SOT-23	DBV	5	250	Green (RoHS & no Sb/Br)	CU NIPDAU   CU SN	Level-1-260C-UNLIM	-40 to 85	Y3KU	<a href="#">Samples</a>
TLVH431BIDBZR	ACTIVE	SOT-23	DBZ	3	3000	Green (RoHS & no Sb/Br)	CU NIPDAU	Level-1-260C-UNLIM	-40 to 85	(Y3K3, Y3KS, Y3KU)	<a href="#">Samples</a>
TLVH431BIDBZRG4	ACTIVE	SOT-23	DBZ	3	3000	Green (RoHS & no Sb/Br)	CU NIPDAU	Level-1-260C-UNLIM	-40 to 85	(Y3K3, Y3KS, Y3KU)	<a href="#">Samples</a>
TLVH431BIDBZT	ACTIVE	SOT-23	DBZ	3	250	Green (RoHS & no Sb/Br)	CU NIPDAU	Level-1-260C-UNLIM	-40 to 85	(Y3KS, Y3KU)	<a href="#">Samples</a>
TLVH431BIDBZTG4	ACTIVE	SOT-23	DBZ	3	250	Green (RoHS & no Sb/Br)	CU NIPDAU	Level-1-260C-UNLIM	-40 to 85	(Y3KS, Y3KU)	<a href="#">Samples</a>
TLVH431BIDCKR	ACTIVE	SC70	DCK	6	3000	Green (RoHS & no Sb/Br)	CU NIPDAU	Level-1-260C-UNLIM	-40 to 85	YJU	<a href="#">Samples</a>
TLVH431BIDCKRE4	ACTIVE	SC70	DCK	6	3000	Green (RoHS & no Sb/Br)	CU NIPDAU	Level-1-260C-UNLIM	-40 to 85	YJU	<a href="#">Samples</a>
TLVH431BIDCKRG4	ACTIVE	SC70	DCK	6	3000	Green (RoHS & no Sb/Br)	CU NIPDAU	Level-1-260C-UNLIM	-40 to 85	YJU	<a href="#">Samples</a>
TLVH431BIDCKT	ACTIVE	SC70	DCK	6	250	Green (RoHS & no Sb/Br)	CU NIPDAU	Level-1-260C-UNLIM	-40 to 85	YJU	<a href="#">Samples</a>
TLVH431BIDCKTG4	ACTIVE	SC70	DCK	6	250	Green (RoHS & no Sb/Br)	CU NIPDAU	Level-1-260C-UNLIM	-40 to 85	YJU	<a href="#">Samples</a>
TLVH431BILP	ACTIVE	TO-92	LP	3	1000	Pb-Free (RoHS)	CU SN	N / A for Pkg Type	-40 to 85	ZB431B	<a href="#">Samples</a>
TLVH431BILPR	ACTIVE	TO-92	LP	3	2000	Pb-Free (RoHS)	CU SN	N / A for Pkg Type	-40 to 85	ZB431B	<a href="#">Samples</a>
TLVH431BIPK	ACTIVE	SOT-89	PK	3	1000	Green (RoHS & no Sb/Br)	CU SN	Level-2-260C-1 YEAR	-40 to 85	V8	<a href="#">Samples</a>
TLVH431BIPKG3	ACTIVE	SOT-89	PK	3	1000	Green (RoHS & no Sb/Br)	CU SN	Level-2-260C-1 YEAR	-40 to 85	V8	<a href="#">Samples</a>
TLVH431BQDBVR	ACTIVE	SOT-23	DBV	5	3000	Green (RoHS & no Sb/Br)	CU NIPDAU   CU SN	Level-1-260C-UNLIM	-40 to 125	Y3LU	<a href="#">Samples</a>
TLVH431BQDBVRE4	ACTIVE	SOT-23	DBV	5	3000	Green (RoHS & no Sb/Br)	CU SN	Level-1-260C-UNLIM	-40 to 125	Y3LU	<a href="#">Samples</a>

Orderable Device	Status (1)	Package Type	Package Drawing	Pins	Package Qty	Eco Plan (2)	Lead/Ball Finish (6)	MSL Peak Temp (3)	Op Temp (°C)	Device Marking (4/5)	Samples
TLVH431BQDBVT	ACTIVE	SOT-23	DBV	5	250	Green (RoHS & no Sb/Br)	CU NIPDAU   CU SN	Level-1-260C-UNLIM	-40 to 125	Y3LU	<a href="#">Samples</a>
TLVH431BQDBZR	ACTIVE	SOT-23	DBZ	3	3000	Green (RoHS & no Sb/Br)	CU NIPDAU	Level-1-260C-UNLIM	-40 to 125	(Y3LS, Y3LU)	<a href="#">Samples</a>
TLVH431BQDBZRG4	ACTIVE	SOT-23	DBZ	3	3000	Green (RoHS & no Sb/Br)	CU NIPDAU	Level-1-260C-UNLIM	-40 to 125	(Y3LS, Y3LU)	<a href="#">Samples</a>
TLVH431BQDBZT	ACTIVE	SOT-23	DBZ	3	250	Green (RoHS & no Sb/Br)	CU NIPDAU	Level-1-260C-UNLIM	-40 to 125	(Y3LS, Y3LU)	<a href="#">Samples</a>
TLVH431BQDBZTG4	ACTIVE	SOT-23	DBZ	3	250	Green (RoHS & no Sb/Br)	CU NIPDAU	Level-1-260C-UNLIM	-40 to 125	(Y3LS, Y3LU)	<a href="#">Samples</a>
TLVH431BQDCKR	ACTIVE	SC70	DCK	6	3000	Green (RoHS & no Sb/Br)	CU NIPDAU	Level-1-260C-UNLIM	-40 to 125	YKU	<a href="#">Samples</a>
TLVH431BQDCKT	ACTIVE	SC70	DCK	6	250	Green (RoHS & no Sb/Br)	CU NIPDAU	Level-1-260C-UNLIM	-40 to 125	YKU	<a href="#">Samples</a>
TLVH431BQLP	ACTIVE	TO-92	LP	3	1000	Pb-Free (RoHS)	CU SN	N / A for Pkg Type	-40 to 125	ZD431B	<a href="#">Samples</a>
TLVH431BQLPE3	ACTIVE	TO-92	LP	3	1000	Pb-Free (RoHS)	CU SN	N / A for Pkg Type	-40 to 125	ZD431B	<a href="#">Samples</a>
TLVH431BQLPR	ACTIVE	TO-92	LP	3	2000	Pb-Free (RoHS)	CU SN	N / A for Pkg Type	-40 to 125	ZD431B	<a href="#">Samples</a>
TLVH431BQPK	ACTIVE	SOT-89	PK	3	1000	Green (RoHS & no Sb/Br)	CU SN	Level-2-260C-1 YEAR	-40 to 125	V9	<a href="#">Samples</a>
TLVH431CDBVR	ACTIVE	SOT-23	DBV	5	3000	Green (RoHS & no Sb/Br)	CU NIPDAU   CU SN	Level-1-260C-UNLIM	0 to 70	Y3UU	<a href="#">Samples</a>
TLVH431CDBVT	ACTIVE	SOT-23	DBV	5	250	Green (RoHS & no Sb/Br)	CU NIPDAU   CU SN	Level-1-260C-UNLIM	0 to 70	Y3UU	<a href="#">Samples</a>
TLVH431CDBZR	ACTIVE	SOT-23	DBZ	3	3000	Green (RoHS & no Sb/Br)	CU NIPDAU	Level-1-260C-UNLIM	0 to 70	(Y3US, Y3UU)	<a href="#">Samples</a>
TLVH431CDBZRG4	ACTIVE	SOT-23	DBZ	3	3000	Green (RoHS & no Sb/Br)	CU NIPDAU	Level-1-260C-UNLIM	0 to 70	(Y3US, Y3UU)	<a href="#">Samples</a>
TLVH431CDBZT	ACTIVE	SOT-23	DBZ	3	250	Green (RoHS & no Sb/Br)	CU NIPDAU	Level-1-260C-UNLIM	0 to 70	(Y3US, Y3UU)	<a href="#">Samples</a>
TLVH431CDBZTG4	ACTIVE	SOT-23	DBZ	3	250	Green (RoHS & no Sb/Br)	CU NIPDAU	Level-1-260C-UNLIM	0 to 70	(Y3US, Y3UU)	<a href="#">Samples</a>
TLVH431CDCKT	ACTIVE	SC70	DCK	6	250	Green (RoHS & no Sb/Br)	CU NIPDAU	Level-1-260C-UNLIM	0 to 70	YUU	<a href="#">Samples</a>

Orderable Device	Status (1)	Package Type	Package Drawing	Pins	Package Qty	Eco Plan (2)	Lead/Ball Finish (6)	MSL Peak Temp (3)	Op Temp (°C)	Device Marking (4/5)	Samples
TLVH431CDCKTE4	ACTIVE	SC70	DCK	6	250	Green (RoHS & no Sb/Br)	CU NIPDAU	Level-1-260C-UNLIM	0 to 70	YUU	<a href="#">Samples</a>
TLVH431CLP	ACTIVE	TO-92	LP	3	1000	Pb-Free (RoHS)	CU SN	N / A for Pkg Type	0 to 70	ZA431	<a href="#">Samples</a>
TLVH431CLPE3	ACTIVE	TO-92	LP	3	1000	Pb-Free (RoHS)	CU SN	N / A for Pkg Type	0 to 70	ZA431	<a href="#">Samples</a>
TLVH431CLPR	ACTIVE	TO-92	LP	3	2000	Pb-Free (RoHS)	CU SN	N / A for Pkg Type	0 to 70	ZA431	<a href="#">Samples</a>
TLVH431CPK	ACTIVE	SOT-89	PK	3	1000	Green (RoHS & no Sb/Br)	CU SN	Level-2-260C-1 YEAR	0 to 70	W4	<a href="#">Samples</a>
TLVH431CPKG3	ACTIVE	SOT-89	PK	3	1000	Green (RoHS & no Sb/Br)	CU SN	Level-2-260C-1 YEAR	0 to 70	W4	<a href="#">Samples</a>
TLVH431IDBVR	ACTIVE	SOT-23	DBV	5	3000	Green (RoHS & no Sb/Br)	CU NIPDAU   CU SN	Level-1-260C-UNLIM	-40 to 85	Y3VU	<a href="#">Samples</a>
TLVH431IDBVT	ACTIVE	SOT-23	DBV	5	250	Green (RoHS & no Sb/Br)	CU NIPDAU   CU SN	Level-1-260C-UNLIM	-40 to 85	Y3VU	<a href="#">Samples</a>
TLVH431IDBVTG4	ACTIVE	SOT-23	DBV	5	250	Green (RoHS & no Sb/Br)	CU NIPDAU	Level-1-260C-UNLIM	-40 to 85	Y3VU	<a href="#">Samples</a>
TLVH431IDBZR	ACTIVE	SOT-23	DBZ	3	3000	Green (RoHS & no Sb/Br)	CU NIPDAU	Level-1-260C-UNLIM	-40 to 85	(Y3VS, Y3VU)	<a href="#">Samples</a>
TLVH431IDBZRG4	ACTIVE	SOT-23	DBZ	3	3000	Green (RoHS & no Sb/Br)	CU NIPDAU	Level-1-260C-UNLIM	-40 to 85	(Y3VS, Y3VU)	<a href="#">Samples</a>
TLVH431IDBZT	ACTIVE	SOT-23	DBZ	3	250	Green (RoHS & no Sb/Br)	CU NIPDAU	Level-1-260C-UNLIM	-40 to 85	(Y3VS, Y3VU)	<a href="#">Samples</a>
TLVH431IDCKR	ACTIVE	SC70	DCK	6	3000	Green (RoHS & no Sb/Br)	CU NIPDAU	Level-1-260C-UNLIM	-40 to 85	YVU	<a href="#">Samples</a>
TLVH431IDCKT	ACTIVE	SC70	DCK	6	250	Green (RoHS & no Sb/Br)	CU NIPDAU	Level-1-260C-UNLIM	-40 to 85	YVU	<a href="#">Samples</a>
TLVH431ILP	ACTIVE	TO-92	LP	3	1000	Pb-Free (RoHS)	CU SN	N / A for Pkg Type	-40 to 85	ZB431	<a href="#">Samples</a>
TLVH431ILPR	ACTIVE	TO-92	LP	3	2000	Pb-Free (RoHS)	CU SN	N / A for Pkg Type	-40 to 85	ZB431	<a href="#">Samples</a>
TLVH431IPK	ACTIVE	SOT-89	PK	3	1000	Green (RoHS & no Sb/Br)	CU SN	Level-2-260C-1 YEAR	-40 to 85	W5	<a href="#">Samples</a>
TLVH431QDBVR	ACTIVE	SOT-23	DBV	5	3000	Green (RoHS & no Sb/Br)	CU NIPDAU   CU SN	Level-1-260C-UNLIM	-40 to 125	Y3MU	<a href="#">Samples</a>

Orderable Device	Status (1)	Package Type	Package Drawing	Pins	Package Qty	Eco Plan (2)	Lead/Ball Finish (6)	MSL Peak Temp (3)	Op Temp (°C)	Device Marking (4/5)	Samples
TLVH431QDBVT	ACTIVE	SOT-23	DBV	5	250	Green (RoHS & no Sb/Br)	CU NIPDAU   CU SN	Level-1-260C-UNLIM	-40 to 125	Y3MU	<a href="#">Samples</a>
TLVH431QDBVTG4	ACTIVE	SOT-23	DBV	5	250	Green (RoHS & no Sb/Br)	CU NIPDAU	Level-1-260C-UNLIM	-40 to 125	Y3MU	<a href="#">Samples</a>
TLVH431QDBZR	ACTIVE	SOT-23	DBZ	3	3000	Green (RoHS & no Sb/Br)	CU NIPDAU	Level-1-260C-UNLIM	-40 to 125	(Y3MS, Y3MU)	<a href="#">Samples</a>
TLVH431QDBZT	ACTIVE	SOT-23	DBZ	3	250	Green (RoHS & no Sb/Br)	CU NIPDAU	Level-1-260C-UNLIM	-40 to 125	(Y3MS, Y3MU)	<a href="#">Samples</a>
TLVH431QDBZTG4	ACTIVE	SOT-23	DBZ	3	250	Green (RoHS & no Sb/Br)	CU NIPDAU	Level-1-260C-UNLIM	-40 to 125	(Y3MS, Y3MU)	<a href="#">Samples</a>
TLVH431QDCKR	ACTIVE	SC70	DCK	6	3000	Green (RoHS & no Sb/Br)	CU NIPDAU	Level-1-260C-UNLIM	-40 to 125	YMU	<a href="#">Samples</a>
TLVH431QDCKT	ACTIVE	SC70	DCK	6	250	Green (RoHS & no Sb/Br)	CU NIPDAU	Level-1-260C-UNLIM	-40 to 125	YMU	<a href="#">Samples</a>
TLVH431QLP	ACTIVE	TO-92	LP	3	1000	Pb-Free (RoHS)	CU SN	N / A for Pkg Type	-40 to 125	ZD431	<a href="#">Samples</a>
TLVH431QLPR	ACTIVE	TO-92	LP	3	2000	Pb-Free (RoHS)	CU SN	N / A for Pkg Type	-40 to 125	ZD431	<a href="#">Samples</a>
TLVH431QPK	ACTIVE	SOT-89	PK	3	1000	Green (RoHS & no Sb/Br)	CU SN	Level-2-260C-1 YEAR	-40 to 125	VC	<a href="#">Samples</a>
TLVH432ACDBZR	ACTIVE	SOT-23	DBZ	3	3000	Green (RoHS & no Sb/Br)	CU NIPDAU	Level-1-260C-UNLIM	0 to 70	(Y2ES, Y2EU)	<a href="#">Samples</a>
TLVH432ACDBZRG4	ACTIVE	SOT-23	DBZ	3	3000	Green (RoHS & no Sb/Br)	CU NIPDAU	Level-1-260C-UNLIM	0 to 70	(Y2ES, Y2EU)	<a href="#">Samples</a>
TLVH432ACDBZT	ACTIVE	SOT-23	DBZ	3	250	Green (RoHS & no Sb/Br)	CU NIPDAU	Level-1-260C-UNLIM	0 to 70	(Y2ES, Y2EU)	<a href="#">Samples</a>
TLVH432AIDBZR	ACTIVE	SOT-23	DBZ	3	3000	Green (RoHS & no Sb/Br)	CU NIPDAU	Level-1-260C-UNLIM	-40 to 85	(Y2FS, Y2FU)	<a href="#">Samples</a>
TLVH432AIPK	ACTIVE	SOT-89	PK	3	1000	Green (RoHS & no Sb/Br)	CU SN	Level-2-260C-1 YEAR	-40 to 85	VL	<a href="#">Samples</a>
TLVH432AQDBZR	ACTIVE	SOT-23	DBZ	3	3000	Green (RoHS & no Sb/Br)	CU NIPDAU	Level-1-260C-UNLIM	-40 to 125	(Y2GS, Y2GU)	<a href="#">Samples</a>
TLVH432AQDBZT	ACTIVE	SOT-23	DBZ	3	250	Green (RoHS & no Sb/Br)	CU NIPDAU	Level-1-260C-UNLIM	-40 to 125	(Y2GS, Y2GU)	<a href="#">Samples</a>
TLVH432BCDBZR	ACTIVE	SOT-23	DBZ	3	3000	Green (RoHS & no Sb/Br)	CU NIPDAU	Level-1-260C-UNLIM	0 to 70	(Y2HS, Y2HU)	<a href="#">Samples</a>

Orderable Device	Status (1)	Package Type	Package Drawing	Pins	Package Qty	Eco Plan (2)	Lead/Ball Finish (6)	MSL Peak Temp (3)	Op Temp (°C)	Device Marking (4/5)	Samples
TLVH432BCDBZRG4	ACTIVE	SOT-23	DBZ	3	3000	Green (RoHS & no Sb/Br)	CU NIPDAU	Level-1-260C-UNLIM	0 to 70	(Y2HS, Y2HU)	<a href="#">Samples</a>
TLVH432BCPK	ACTIVE	SOT-89	PK	3	1000	Green (RoHS & no Sb/Br)	CU SN	Level-2-260C-1 YEAR	0 to 70	VN	<a href="#">Samples</a>
TLVH432BIDBZR	ACTIVE	SOT-23	DBZ	3	3000	Green (RoHS & no Sb/Br)	CU NIPDAU	Level-1-260C-UNLIM	-40 to 85	(Y2JS, Y2JU)	<a href="#">Samples</a>
TLVH432BQDBZR	ACTIVE	SOT-23	DBZ	3	3000	Green (RoHS & no Sb/Br)	CU NIPDAU	Level-1-260C-UNLIM	-40 to 125	(Y2KS, Y2KU)	<a href="#">Samples</a>
TLVH432BQDBZT	ACTIVE	SOT-23	DBZ	3	250	Green (RoHS & no Sb/Br)	CU NIPDAU	Level-1-260C-UNLIM	-40 to 125	(Y2KS, Y2KU)	<a href="#">Samples</a>
TLVH432BQDBZTG4	ACTIVE	SOT-23	DBZ	3	250	Green (RoHS & no Sb/Br)	CU NIPDAU	Level-1-260C-UNLIM	-40 to 125	(Y2KS, Y2KU)	<a href="#">Samples</a>
TLVH432CDBZR	ACTIVE	SOT-23	DBZ	3	3000	Green (RoHS & no Sb/Br)	CU NIPDAU	Level-1-260C-UNLIM	0 to 70	(Y2AS, Y2AU)	<a href="#">Samples</a>
TLVH432CDBZT	ACTIVE	SOT-23	DBZ	3	250	Green (RoHS & no Sb/Br)	CU NIPDAU	Level-1-260C-UNLIM	0 to 70	(Y2AS, Y2AU)	<a href="#">Samples</a>
TLVH432CPK	ACTIVE	SOT-89	PK	3	1000	Green (RoHS & no Sb/Br)	CU SN	Level-2-260C-1 YEAR	0 to 70	VG	<a href="#">Samples</a>
TLVH432IDBZR	ACTIVE	SOT-23	DBZ	3	3000	Green (RoHS & no Sb/Br)	CU NIPDAU	Level-1-260C-UNLIM	-40 to 85	(Y2BS, Y2BU)	<a href="#">Samples</a>
TLVH432QDBZR	ACTIVE	SOT-23	DBZ	3	3000	Green (RoHS & no Sb/Br)	CU NIPDAU	Level-1-260C-UNLIM	-40 to 125	(Y2DS, Y2DU)	<a href="#">Samples</a>
TLVH432QDBZT	ACTIVE	SOT-23	DBZ	3	250	Green (RoHS & no Sb/Br)	CU NIPDAU	Level-1-260C-UNLIM	-40 to 125	(Y2DS, Y2DU)	<a href="#">Samples</a>
TLVH432QPK	ACTIVE	SOT-89	PK	3	1000	Green (RoHS & no Sb/Br)	CU SN	Level-2-260C-1 YEAR	-40 to 125	VJ	<a href="#">Samples</a>
TLVH432QPKG3	ACTIVE	SOT-89	PK	3	1000	Green (RoHS & no Sb/Br)	CU SN	Level-2-260C-1 YEAR	-40 to 125	VJ	<a href="#">Samples</a>

(1) The marketing status values are defined as follows:

**ACTIVE:** Product device recommended for new designs.

**LIFEBUY:** TI has announced that the device will be discontinued, and a lifetime-buy period is in effect.

**NRND:** Not recommended for new designs. Device is in production to support existing customers, but TI does not recommend using this part in a new design.

**PREVIEW:** Device has been announced but is not in production. Samples may or may not be available.

**OBSOLETE:** TI has discontinued the production of the device.

(2) **RoHS:** TI defines "RoHS" to mean semiconductor products that are compliant with the current EU RoHS requirements for all 10 RoHS substances, including the requirement that RoHS substance do not exceed 0.1% by weight in homogeneous materials. Where designed to be soldered at high temperatures, "RoHS" products are suitable for use in specified lead-free processes. TI may reference these types of products as "Pb-Free".

**RoHS Exempt:** TI defines "RoHS Exempt" to mean products that contain lead but are compliant with EU RoHS pursuant to a specific EU RoHS exemption.

**Green:** TI defines "Green" to mean the content of Chlorine (Cl) and Bromine (Br) based flame retardants meet JS709B low halogen requirements of  $\leq 1000$ ppm threshold. Antimony trioxide based flame retardants must also meet the  $\leq 1000$ ppm threshold requirement.

(3) MSL, Peak Temp. - The Moisture Sensitivity Level rating according to the JEDEC industry standard classifications, and peak solder temperature.

(4) There may be additional marking, which relates to the logo, the lot trace code information, or the environmental category on the device.

(5) Multiple Device Markings will be inside parentheses. Only one Device Marking contained in parentheses and separated by a "~" will appear on a device. If a line is indented then it is a continuation of the previous line and the two combined represent the entire Device Marking for that device.

(6) Lead/Ball Finish - Orderable Devices may have multiple material finish options. Finish options are separated by a vertical ruled line. Lead/Ball Finish values may wrap to two lines if the finish value exceeds the maximum column width.

**Important Information and Disclaimer:** The information provided on this page represents TI's knowledge and belief as of the date that it is provided. TI bases its knowledge and belief on information provided by third parties, and makes no representation or warranty as to the accuracy of such information. Efforts are underway to better integrate information from third parties. TI has taken and continues to take reasonable steps to provide representative and accurate information but may not have conducted destructive testing or chemical analysis on incoming materials and chemicals. TI and TI suppliers consider certain information to be proprietary, and thus CAS numbers and other limited information may not be available for release.

In no event shall TI's liability arising out of such information exceed the total purchase price of the TI part(s) at issue in this document sold by TI to Customer on an annual basis.

**OTHER QUALIFIED VERSIONS OF TLVH431A, TLVH431B :**

- Automotive: [TLVH431A-Q1](#), [TLVH431B-Q1](#)

NOTE: Qualified Version Definitions:

- Automotive - Q100 devices qualified for high-reliability automotive applications targeting zero defects

## TAPE AND REEL INFORMATION

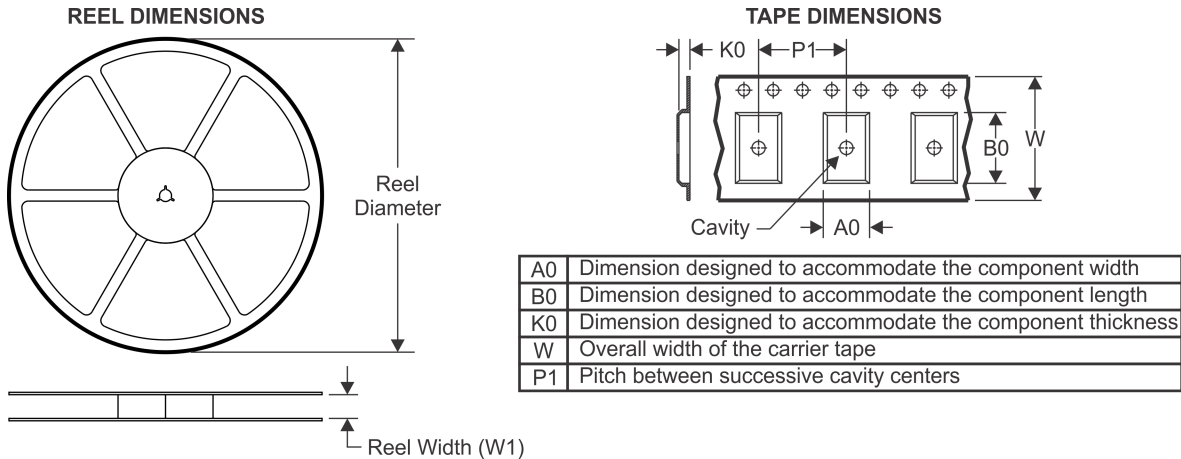

### QUADRANT ASSIGNMENTS FOR PIN 1 ORIENTATION IN TAPE



\*All dimensions are nominal

Device	Package Type	Package Drawing	Pins	SPQ	Reel Diameter (mm)	Reel Width W1 (mm)	A0 (mm)	B0 (mm)	K0 (mm)	P1 (mm)	W (mm)	Pin1 Quadrant
TLVH431ACDBVR	SOT-23	DBV	5	3000	178.0	9.0	3.23	3.17	1.37	4.0	8.0	Q3
TLVH431ACDBVR	SOT-23	DBV	5	3000	178.0	9.0	3.3	3.2	1.4	4.0	8.0	Q3
TLVH431ACDBVRG4	SOT-23	DBV	5	3000	178.0	9.0	3.23	3.17	1.37	4.0	8.0	Q3
TLVH431ACDBVT	SOT-23	DBV	5	250	178.0	9.0	3.3	3.2	1.4	4.0	8.0	Q3
TLVH431ACDBVT	SOT-23	DBV	5	250	178.0	9.0	3.23	3.17	1.37	4.0	8.0	Q3
TLVH431ACDBZR	SOT-23	DBZ	3	3000	180.0	8.4	3.15	2.77	1.22	4.0	8.0	Q3
TLVH431ACDBZT	SOT-23	DBZ	3	250	180.0	8.4	3.15	2.77	1.22	4.0	8.0	Q3
TLVH431ACDCKR	SC70	DCK	6	3000	179.0	8.4	2.2	2.5	1.2	4.0	8.0	Q3
TLVH431ACDCKT	SC70	DCK	6	250	179.0	8.4	2.2	2.5	1.2	4.0	8.0	Q3
TLVH431ACPK	SOT-89	PK	3	1000	180.0	12.4	4.91	4.52	1.9	8.0	12.0	Q3
TLVH431AIDBVR	SOT-23	DBV	5	3000	178.0	9.0	3.3	3.2	1.4	4.0	8.0	Q3
TLVH431AIDBVR	SOT-23	DBV	5	3000	180.0	8.4	3.2	3.2	1.4	4.0	8.0	Q3
TLVH431AIDBVT	SOT-23	DBV	5	250	180.0	8.4	3.2	3.2	1.4	4.0	8.0	Q3
TLVH431AIDBVT	SOT-23	DBV	5	250	178.0	9.0	3.3	3.2	1.4	4.0	8.0	Q3
TLVH431AIDBZR	SOT-23	DBZ	3	3000	180.0	8.4	3.15	2.77	1.22	4.0	8.0	Q3
TLVH431AIDBZT	SOT-23	DBZ	3	250	180.0	8.4	3.15	2.77	1.22	4.0	8.0	Q3
TLVH431AIDBZTG4	SOT-23	DBZ	3	250	180.0	8.4	3.15	2.77	1.22	4.0	8.0	Q3
TLVH431AIDCKR	SC70	DCK	6	3000	179.0	8.4	2.2	2.5	1.2	4.0	8.0	Q3

Device	Package Type	Package Drawing	Pins	SPQ	Reel Diameter (mm)	Reel Width W1 (mm)	A0 (mm)	B0 (mm)	K0 (mm)	P1 (mm)	W (mm)	Pin1 Quadrant
TLVH431AIDCKT	SC70	DCK	6	250	179.0	8.4	2.2	2.5	1.2	4.0	8.0	Q3
TLVH431AIPK	SOT-89	PK	3	1000	180.0	12.4	4.91	4.52	1.9	8.0	12.0	Q3
TLVH431AQDBVR	SOT-23	DBV	5	3000	178.0	9.0	3.3	3.2	1.4	4.0	8.0	Q3
TLVH431AQDBVR	SOT-23	DBV	5	3000	180.0	8.4	3.2	3.2	1.4	4.0	8.0	Q3
TLVH431AQDBVT	SOT-23	DBV	5	250	178.0	9.0	3.3	3.2	1.4	4.0	8.0	Q3
TLVH431AQDBVT	SOT-23	DBV	5	250	180.0	8.4	3.2	3.2	1.4	4.0	8.0	Q3
TLVH431AQDBZR	SOT-23	DBZ	3	3000	180.0	8.4	3.15	2.77	1.22	4.0	8.0	Q3
TLVH431AQDBZT	SOT-23	DBZ	3	250	180.0	8.4	3.15	2.77	1.22	4.0	8.0	Q3
TLVH431AQDBZTG4	SOT-23	DBZ	3	250	180.0	8.4	3.15	2.77	1.22	4.0	8.0	Q3
TLVH431AQDCKR	SC70	DCK	6	3000	179.0	8.4	2.2	2.5	1.2	4.0	8.0	Q3
TLVH431AQDCKT	SC70	DCK	6	250	179.0	8.4	2.2	2.5	1.2	4.0	8.0	Q3
TLVH431AQPK	SOT-89	PK	3	1000	180.0	12.4	4.91	4.52	1.9	8.0	12.0	Q3
TLVH431BCDBVR	SOT-23	DBV	5	3000	180.0	8.4	3.2	3.2	1.4	4.0	8.0	Q3
TLVH431BCDBVR	SOT-23	DBV	5	3000	178.0	9.0	3.3	3.2	1.4	4.0	8.0	Q3
TLVH431BCDBVT	SOT-23	DBV	5	250	180.0	8.4	3.2	3.2	1.4	4.0	8.0	Q3
TLVH431BCDBVT	SOT-23	DBV	5	250	178.0	9.0	3.3	3.2	1.4	4.0	8.0	Q3
TLVH431BCDBZR	SOT-23	DBZ	3	3000	180.0	8.4	3.15	2.77	1.22	4.0	8.0	Q3
TLVH431BCDBZT	SOT-23	DBZ	3	250	180.0	8.4	3.15	2.77	1.22	4.0	8.0	Q3
TLVH431BCDCKR	SC70	DCK	6	3000	179.0	8.4	2.2	2.5	1.2	4.0	8.0	Q3
TLVH431BCDCKT	SC70	DCK	6	250	179.0	8.4	2.2	2.5	1.2	4.0	8.0	Q3
TLVH431BCPK	SOT-89	PK	3	1000	180.0	12.4	4.91	4.52	1.9	8.0	12.0	Q3
TLVH431BIDBVR	SOT-23	DBV	5	3000	178.0	9.0	3.3	3.2	1.4	4.0	8.0	Q3
TLVH431BIDBVR	SOT-23	DBV	5	3000	180.0	8.4	3.2	3.2	1.4	4.0	8.0	Q3
TLVH431BIDBVT	SOT-23	DBV	5	250	178.0	9.0	3.3	3.2	1.4	4.0	8.0	Q3
TLVH431BIDBVT	SOT-23	DBV	5	250	180.0	8.4	3.2	3.2	1.4	4.0	8.0	Q3
TLVH431BIDBZR	SOT-23	DBZ	3	3000	180.0	8.4	3.15	2.77	1.22	4.0	8.0	Q3
TLVH431BIDBZT	SOT-23	DBZ	3	250	180.0	8.4	3.15	2.77	1.22	4.0	8.0	Q3
TLVH431BIDBZTG4	SOT-23	DBZ	3	250	180.0	8.4	3.15	2.77	1.22	4.0	8.0	Q3
TLVH431BIDCKR	SC70	DCK	6	3000	179.0	8.4	2.2	2.5	1.2	4.0	8.0	Q3
TLVH431BIDCKT	SC70	DCK	6	250	179.0	8.4	2.2	2.5	1.2	4.0	8.0	Q3
TLVH431BIPK	SOT-89	PK	3	1000	180.0	12.4	4.91	4.52	1.9	8.0	12.0	Q3
TLVH431BQDBVR	SOT-23	DBV	5	3000	179.0	8.4	3.2	3.2	1.4	4.0	8.0	Q3
TLVH431BQDBVR	SOT-23	DBV	5	3000	178.0	9.0	3.3	3.2	1.4	4.0	8.0	Q3
TLVH431BQDBVT	SOT-23	DBV	5	250	178.0	9.0	3.3	3.2	1.4	4.0	8.0	Q3
TLVH431BQDBVT	SOT-23	DBV	5	250	179.0	8.4	3.2	3.2	1.4	4.0	8.0	Q3
TLVH431BQDBZR	SOT-23	DBZ	3	3000	180.0	8.4	3.15	2.77	1.22	4.0	8.0	Q3
TLVH431BQDBZRG4	SOT-23	DBZ	3	3000	180.0	8.4	3.15	2.77	1.22	4.0	8.0	Q3
TLVH431BQDBZT	SOT-23	DBZ	3	250	180.0	8.4	3.15	2.77	1.22	4.0	8.0	Q3
TLVH431BQDBZTG4	SOT-23	DBZ	3	250	180.0	8.4	3.15	2.77	1.22	4.0	8.0	Q3
TLVH431BQDCKR	SC70	DCK	6	3000	179.0	8.4	2.2	2.5	1.2	4.0	8.0	Q3
TLVH431BQDCKT	SC70	DCK	6	250	179.0	8.4	2.2	2.5	1.2	4.0	8.0	Q3
TLVH431BQPK	SOT-89	PK	3	1000	180.0	12.4	4.91	4.52	1.9	8.0	12.0	Q3
TLVH431CDBVR	SOT-23	DBV	5	3000	180.0	8.4	3.2	3.2	1.4	4.0	8.0	Q3

Device	Package Type	Package Drawing	Pins	SPQ	Reel Diameter (mm)	Reel Width W1 (mm)	A0 (mm)	B0 (mm)	K0 (mm)	P1 (mm)	W (mm)	Pin1 Quadrant
TLVH431CDBVR	SOT-23	DBV	5	3000	178.0	9.0	3.3	3.2	1.4	4.0	8.0	Q3
TLVH431CDBVT	SOT-23	DBV	5	250	179.0	8.4	3.2	3.2	1.4	4.0	8.0	Q3
TLVH431CDBVT	SOT-23	DBV	5	250	178.0	9.0	3.3	3.2	1.4	4.0	8.0	Q3
TLVH431CDBZR	SOT-23	DBZ	3	3000	180.0	8.4	3.15	2.77	1.22	4.0	8.0	Q3
TLVH431CDBZT	SOT-23	DBZ	3	250	180.0	8.4	3.15	2.77	1.22	4.0	8.0	Q3
TLVH431CDBZTG4	SOT-23	DBZ	3	250	180.0	8.4	3.15	2.77	1.22	4.0	8.0	Q3
TLVH431CDCKT	SC70	DCK	6	250	179.0	8.4	2.2	2.5	1.2	4.0	8.0	Q3
TLVH431CPK	SOT-89	PK	3	1000	180.0	12.4	4.91	4.52	1.9	8.0	12.0	Q3
TLVH431IDBVR	SOT-23	DBV	5	3000	178.0	9.0	3.3	3.2	1.4	4.0	8.0	Q3
TLVH431IDBVR	SOT-23	DBV	5	3000	180.0	8.4	3.2	3.2	1.4	4.0	8.0	Q3
TLVH431IDBVT	SOT-23	DBV	5	250	180.0	8.4	3.2	3.2	1.4	4.0	8.0	Q3
TLVH431IDBVT	SOT-23	DBV	5	250	178.0	9.0	3.3	3.2	1.4	4.0	8.0	Q3
TLVH431IDBZR	SOT-23	DBZ	3	3000	180.0	8.4	3.15	2.77	1.22	4.0	8.0	Q3
TLVH431IDBZT	SOT-23	DBZ	3	250	180.0	8.4	3.15	2.77	1.22	4.0	8.0	Q3
TLVH431IDCKR	SC70	DCK	6	3000	179.0	8.4	2.2	2.5	1.2	4.0	8.0	Q3
TLVH431IDCKT	SC70	DCK	6	250	179.0	8.4	2.2	2.5	1.2	4.0	8.0	Q3
TLVH431IPK	SOT-89	PK	3	1000	180.0	12.4	4.91	4.52	1.9	8.0	12.0	Q3
TLVH431QDBVR	SOT-23	DBV	5	3000	178.0	9.0	3.3	3.2	1.4	4.0	8.0	Q3
TLVH431QDBVR	SOT-23	DBV	5	3000	180.0	8.4	3.2	3.2	1.4	4.0	8.0	Q3
TLVH431QDBVT	SOT-23	DBV	5	250	178.0	9.0	3.3	3.2	1.4	4.0	8.0	Q3
TLVH431QDBVT	SOT-23	DBV	5	250	180.0	8.4	3.2	3.2	1.4	4.0	8.0	Q3
TLVH431QDBZR	SOT-23	DBZ	3	3000	180.0	8.4	3.15	2.77	1.22	4.0	8.0	Q3
TLVH431QDBZT	SOT-23	DBZ	3	250	180.0	8.4	3.15	2.77	1.22	4.0	8.0	Q3
TLVH431QDBZTG4	SOT-23	DBZ	3	250	180.0	8.4	3.15	2.77	1.22	4.0	8.0	Q3
TLVH431QDCKR	SC70	DCK	6	3000	179.0	8.4	2.2	2.5	1.2	4.0	8.0	Q3
TLVH431QDCKT	SC70	DCK	6	250	179.0	8.4	2.2	2.5	1.2	4.0	8.0	Q3
TLVH431QPK	SOT-89	PK	3	1000	180.0	12.4	4.91	4.52	1.9	8.0	12.0	Q3
TLVH432ACDBZR	SOT-23	DBZ	3	3000	180.0	8.4	3.15	2.77	1.22	4.0	8.0	Q3
TLVH432ACDBZT	SOT-23	DBZ	3	250	180.0	8.4	3.15	2.77	1.22	4.0	8.0	Q3
TLVH432AIDBZR	SOT-23	DBZ	3	3000	180.0	8.4	3.15	2.77	1.22	4.0	8.0	Q3
TLVH432AIPK	SOT-89	PK	3	1000	180.0	12.4	4.91	4.52	1.9	8.0	12.0	Q3
TLVH432AQDBZR	SOT-23	DBZ	3	3000	180.0	8.4	3.15	2.77	1.22	4.0	8.0	Q3
TLVH432AQDBZT	SOT-23	DBZ	3	250	180.0	8.4	3.15	2.77	1.22	4.0	8.0	Q3
TLVH432BCDBZR	SOT-23	DBZ	3	3000	180.0	8.4	3.15	2.77	1.22	4.0	8.0	Q3
TLVH432BCDBZRG4	SOT-23	DBZ	3	3000	180.0	8.4	3.15	2.77	1.22	4.0	8.0	Q3
TLVH432BCPK	SOT-89	PK	3	1000	180.0	12.4	4.91	4.52	1.9	8.0	12.0	Q3
TLVH432BIDBZR	SOT-23	DBZ	3	3000	180.0	8.4	3.15	2.77	1.22	4.0	8.0	Q3
TLVH432BQDBZR	SOT-23	DBZ	3	3000	180.0	8.4	3.15	2.77	1.22	4.0	8.0	Q3
TLVH432BQDBZT	SOT-23	DBZ	3	250	180.0	8.4	3.15	2.77	1.22	4.0	8.0	Q3
TLVH432BQDBZTG4	SOT-23	DBZ	3	250	180.0	8.4	3.15	2.77	1.22	4.0	8.0	Q3
TLVH432CDBZR	SOT-23	DBZ	3	3000	180.0	8.4	3.15	2.77	1.22	4.0	8.0	Q3
TLVH432CDBZT	SOT-23	DBZ	3	250	180.0	8.4	3.15	2.77	1.22	4.0	8.0	Q3
TLVH432CPK	SOT-89	PK	3	1000	180.0	12.4	4.91	4.52	1.9	8.0	12.0	Q3

Device	Package Type	Package Drawing	Pins	SPQ	Reel Diameter (mm)	Reel Width W1 (mm)	A0 (mm)	B0 (mm)	K0 (mm)	P1 (mm)	W (mm)	Pin1 Quadrant
TLVH432IDBZR	SOT-23	DBZ	3	3000	180.0	8.4	3.15	2.77	1.22	4.0	8.0	Q3
TLVH432QDBZR	SOT-23	DBZ	3	3000	180.0	8.4	3.15	2.77	1.22	4.0	8.0	Q3
TLVH432QDBZT	SOT-23	DBZ	3	250	180.0	8.4	3.15	2.77	1.22	4.0	8.0	Q3
TLVH432QPK	SOT-89	PK	3	1000	180.0	12.4	4.91	4.52	1.9	8.0	12.0	Q3

**TAPE AND REEL BOX DIMENSIONS**

\*All dimensions are nominal

Device	Package Type	Package Drawing	Pins	SPQ	Length (mm)	Width (mm)	Height (mm)
TLVH431ACDBVR	SOT-23	DBV	5	3000	180.0	180.0	18.0
TLVH431ACDBVR	SOT-23	DBV	5	3000	180.0	180.0	18.0
TLVH431ACDBVRG4	SOT-23	DBV	5	3000	180.0	180.0	18.0
TLVH431ACDBVT	SOT-23	DBV	5	250	180.0	180.0	18.0
TLVH431ACDBVT	SOT-23	DBV	5	250	180.0	180.0	18.0
TLVH431ACDBZR	SOT-23	DBZ	3	3000	183.0	183.0	20.0
TLVH431ACDBZT	SOT-23	DBZ	3	250	183.0	183.0	20.0
TLVH431ACDCKR	SC70	DCK	6	3000	203.0	203.0	35.0
TLVH431ACDCKT	SC70	DCK	6	250	203.0	203.0	35.0
TLVH431ACPK	SOT-89	PK	3	1000	340.0	340.0	38.0
TLVH431AIDBVR	SOT-23	DBV	5	3000	180.0	180.0	18.0
TLVH431AIDBVR	SOT-23	DBV	5	3000	203.0	203.0	35.0
TLVH431AIDBVT	SOT-23	DBV	5	250	203.0	203.0	35.0

Device	Package Type	Package Drawing	Pins	SPQ	Length (mm)	Width (mm)	Height (mm)
TLVH431AIDBVT	SOT-23	DBV	5	250	180.0	180.0	18.0
TLVH431AIDBZR	SOT-23	DBZ	3	3000	183.0	183.0	20.0
TLVH431AIDBZT	SOT-23	DBZ	3	250	183.0	183.0	20.0
TLVH431AIDBZTG4	SOT-23	DBZ	3	250	183.0	183.0	20.0
TLVH431AIDCKR	SC70	DCK	6	3000	203.0	203.0	35.0
TLVH431AIDCKT	SC70	DCK	6	250	203.0	203.0	35.0
TLVH431AIPK	SOT-89	PK	3	1000	340.0	340.0	38.0
TLVH431AQDBVR	SOT-23	DBV	5	3000	180.0	180.0	18.0
TLVH431AQDBVR	SOT-23	DBV	5	3000	203.0	203.0	35.0
TLVH431AQDBVT	SOT-23	DBV	5	250	180.0	180.0	18.0
TLVH431AQDBVT	SOT-23	DBV	5	250	203.0	203.0	35.0
TLVH431AQDBZR	SOT-23	DBZ	3	3000	183.0	183.0	20.0
TLVH431AQDBZT	SOT-23	DBZ	3	250	183.0	183.0	20.0
TLVH431AQDBZTG4	SOT-23	DBZ	3	250	183.0	183.0	20.0
TLVH431AQDCKR	SC70	DCK	6	3000	203.0	203.0	35.0
TLVH431AQDCKT	SC70	DCK	6	250	203.0	203.0	35.0
TLVH431AQPCK	SOT-89	PK	3	1000	340.0	340.0	38.0
TLVH431BCDBVR	SOT-23	DBV	5	3000	203.0	203.0	35.0
TLVH431BCDBVR	SOT-23	DBV	5	3000	180.0	180.0	18.0
TLVH431BCDBVT	SOT-23	DBV	5	250	203.0	203.0	35.0
TLVH431BCDBVT	SOT-23	DBV	5	250	180.0	180.0	18.0
TLVH431BCDBZR	SOT-23	DBZ	3	3000	183.0	183.0	20.0
TLVH431BCDBZT	SOT-23	DBZ	3	250	183.0	183.0	20.0
TLVH431BCDCKR	SC70	DCK	6	3000	203.0	203.0	35.0
TLVH431BCDCKT	SC70	DCK	6	250	203.0	203.0	35.0
TLVH431BCPK	SOT-89	PK	3	1000	340.0	340.0	38.0
TLVH431BIDBVR	SOT-23	DBV	5	3000	180.0	180.0	18.0
TLVH431BIDBVR	SOT-23	DBV	5	3000	203.0	203.0	35.0
TLVH431BIDBVT	SOT-23	DBV	5	250	180.0	180.0	18.0
TLVH431BIDBVT	SOT-23	DBV	5	250	203.0	203.0	35.0
TLVH431BIDBZR	SOT-23	DBZ	3	3000	183.0	183.0	20.0
TLVH431BIDBZT	SOT-23	DBZ	3	250	183.0	183.0	20.0
TLVH431BIDBZTG4	SOT-23	DBZ	3	250	183.0	183.0	20.0
TLVH431BIDCKR	SC70	DCK	6	3000	203.0	203.0	35.0
TLVH431BIDCKT	SC70	DCK	6	250	203.0	203.0	35.0
TLVH431BIPK	SOT-89	PK	3	1000	340.0	340.0	38.0
TLVH431BQDBVR	SOT-23	DBV	5	3000	203.0	203.0	35.0
TLVH431BQDBVR	SOT-23	DBV	5	3000	180.0	180.0	18.0
TLVH431BQDBVT	SOT-23	DBV	5	250	180.0	180.0	18.0
TLVH431BQDBVT	SOT-23	DBV	5	250	203.0	203.0	35.0
TLVH431BQDBZR	SOT-23	DBZ	3	3000	183.0	183.0	20.0
TLVH431BQDBZRG4	SOT-23	DBZ	3	3000	183.0	183.0	20.0
TLVH431BQDBZT	SOT-23	DBZ	3	250	183.0	183.0	20.0
TLVH431BQDBZTG4	SOT-23	DBZ	3	250	183.0	183.0	20.0

Device	Package Type	Package Drawing	Pins	SPQ	Length (mm)	Width (mm)	Height (mm)
TLVH431BQDCKR	SC70	DCK	6	3000	203.0	203.0	35.0
TLVH431BQDCKT	SC70	DCK	6	250	203.0	203.0	35.0
TLVH431BQPK	SOT-89	PK	3	1000	340.0	340.0	38.0
TLVH431CDBVR	SOT-23	DBV	5	3000	203.0	203.0	35.0
TLVH431CDBVR	SOT-23	DBV	5	3000	180.0	180.0	18.0
TLVH431CDBVT	SOT-23	DBV	5	250	203.0	203.0	35.0
TLVH431CDBVT	SOT-23	DBV	5	250	180.0	180.0	18.0
TLVH431CDBZR	SOT-23	DBZ	3	3000	183.0	183.0	20.0
TLVH431CDBZT	SOT-23	DBZ	3	250	183.0	183.0	20.0
TLVH431CDBZTG4	SOT-23	DBZ	3	250	183.0	183.0	20.0
TLVH431CDCKT	SC70	DCK	6	250	203.0	203.0	35.0
TLVH431CPK	SOT-89	PK	3	1000	340.0	340.0	38.0
TLVH431IDBVR	SOT-23	DBV	5	3000	180.0	180.0	18.0
TLVH431IDBVR	SOT-23	DBV	5	3000	203.0	203.0	35.0
TLVH431IDBVT	SOT-23	DBV	5	250	203.0	203.0	35.0
TLVH431IDBVT	SOT-23	DBV	5	250	180.0	180.0	18.0
TLVH431IDBZR	SOT-23	DBZ	3	3000	183.0	183.0	20.0
TLVH431IDBZT	SOT-23	DBZ	3	250	183.0	183.0	20.0
TLVH431IDCKR	SC70	DCK	6	3000	203.0	203.0	35.0
TLVH431IDCKT	SC70	DCK	6	250	203.0	203.0	35.0
TLVH431IPK	SOT-89	PK	3	1000	340.0	340.0	38.0
TLVH431QDBVR	SOT-23	DBV	5	3000	180.0	180.0	18.0
TLVH431QDBVR	SOT-23	DBV	5	3000	203.0	203.0	35.0
TLVH431QDBVT	SOT-23	DBV	5	250	180.0	180.0	18.0
TLVH431QDBVT	SOT-23	DBV	5	250	203.0	203.0	35.0
TLVH431QDBZR	SOT-23	DBZ	3	3000	183.0	183.0	20.0
TLVH431QDBZT	SOT-23	DBZ	3	250	183.0	183.0	20.0
TLVH431QDBZTG4	SOT-23	DBZ	3	250	183.0	183.0	20.0
TLVH431QDCKR	SC70	DCK	6	3000	203.0	203.0	35.0
TLVH431QDCKT	SC70	DCK	6	250	203.0	203.0	35.0
TLVH431QPK	SOT-89	PK	3	1000	340.0	340.0	38.0
TLVH432ACDBZR	SOT-23	DBZ	3	3000	183.0	183.0	20.0
TLVH432ACDBZT	SOT-23	DBZ	3	250	183.0	183.0	20.0
TLVH432AIDBZR	SOT-23	DBZ	3	3000	183.0	183.0	20.0
TLVH432AIPK	SOT-89	PK	3	1000	340.0	340.0	38.0
TLVH432AQDBZR	SOT-23	DBZ	3	3000	183.0	183.0	20.0
TLVH432AQDBZT	SOT-23	DBZ	3	250	183.0	183.0	20.0
TLVH432BCDBZR	SOT-23	DBZ	3	3000	183.0	183.0	20.0
TLVH432BCDBZRG4	SOT-23	DBZ	3	3000	183.0	183.0	20.0
TLVH432BCPK	SOT-89	PK	3	1000	340.0	340.0	38.0
TLVH432BIDBZR	SOT-23	DBZ	3	3000	183.0	183.0	20.0
TLVH432BQDBZR	SOT-23	DBZ	3	3000	183.0	183.0	20.0
TLVH432BQDBZT	SOT-23	DBZ	3	250	183.0	183.0	20.0
TLVH432BQDBZTG4	SOT-23	DBZ	3	250	183.0	183.0	20.0

---

Device	Package Type	Package Drawing	Pins	SPQ	Length (mm)	Width (mm)	Height (mm)
TLVH432CDBZR	SOT-23	DBZ	3	3000	183.0	183.0	20.0
TLVH432CDBZT	SOT-23	DBZ	3	250	183.0	183.0	20.0
TLVH432CPK	SOT-89	PK	3	1000	340.0	340.0	38.0
TLVH432IDBZR	SOT-23	DBZ	3	3000	183.0	183.0	20.0
TLVH432QDBZR	SOT-23	DBZ	3	3000	183.0	183.0	20.0
TLVH432QDBZT	SOT-23	DBZ	3	250	183.0	183.0	20.0
TLVH432QPK	SOT-89	PK	3	1000	340.0	340.0	38.0

PK (R-PSS0-F3)

PLASTIC SINGLE-IN-LINE PACKAGE

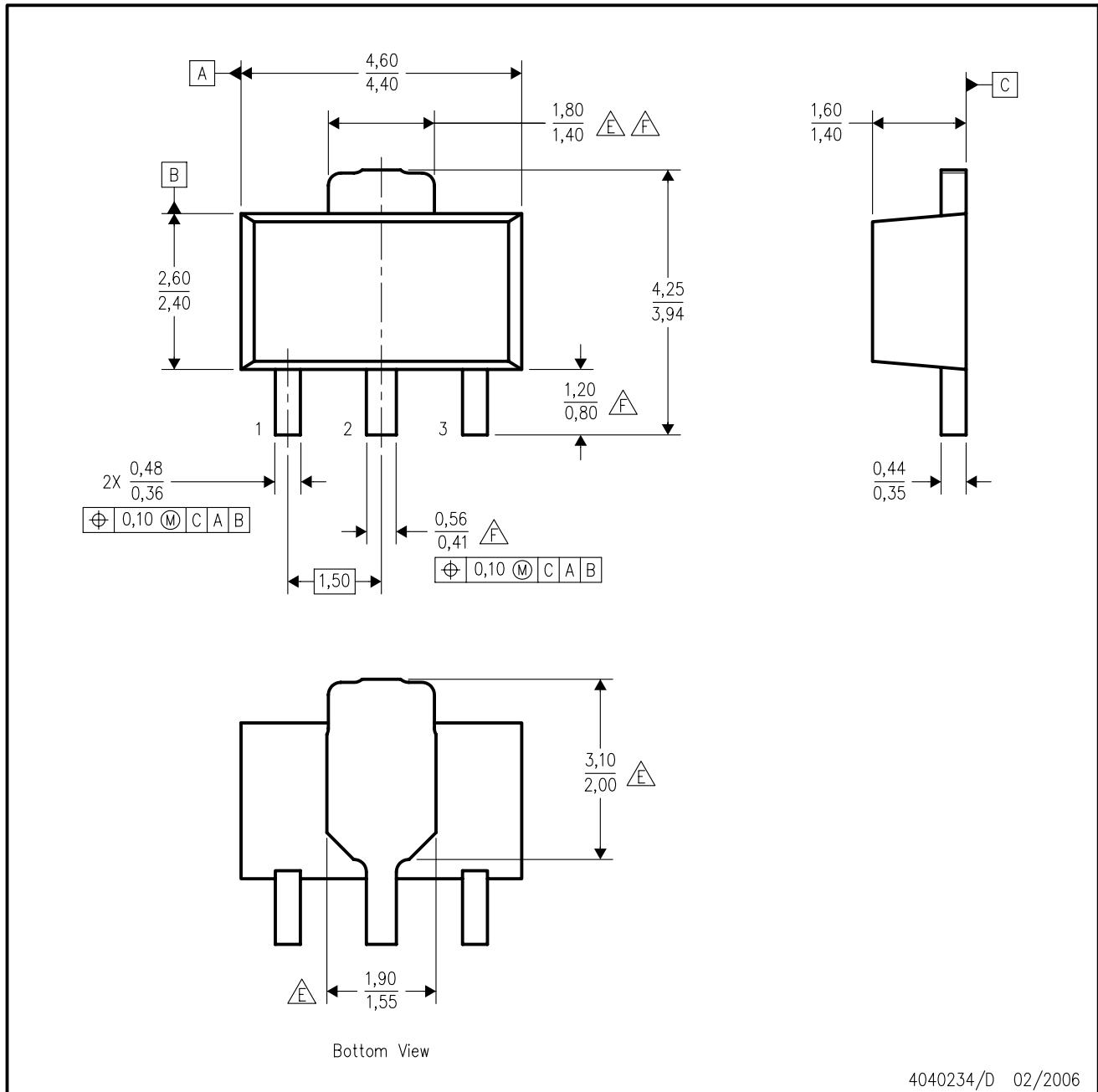

4040234/D 02/2006

- NOTES:
- All linear dimensions are in millimeters. Dimensioning and tolerancing per ASME Y14.5M-1994.
  - This drawing is subject to change without notice.
  - The center lead is in electrical contact with the tab.
  - Body dimensions do not include mold flash or protrusion. Mold flash and protrusion not to exceed 0.15 per side.
- △E Thermal pad contour optional within these dimensions.  
 △F Falls within JEDEC TO-243 variation AA, except minimum lead length, pin 2 minimum lead width, minimum tab width.

DCK (R-PDSO-G6)

PLASTIC SMALL-OUTLINE PACKAGE

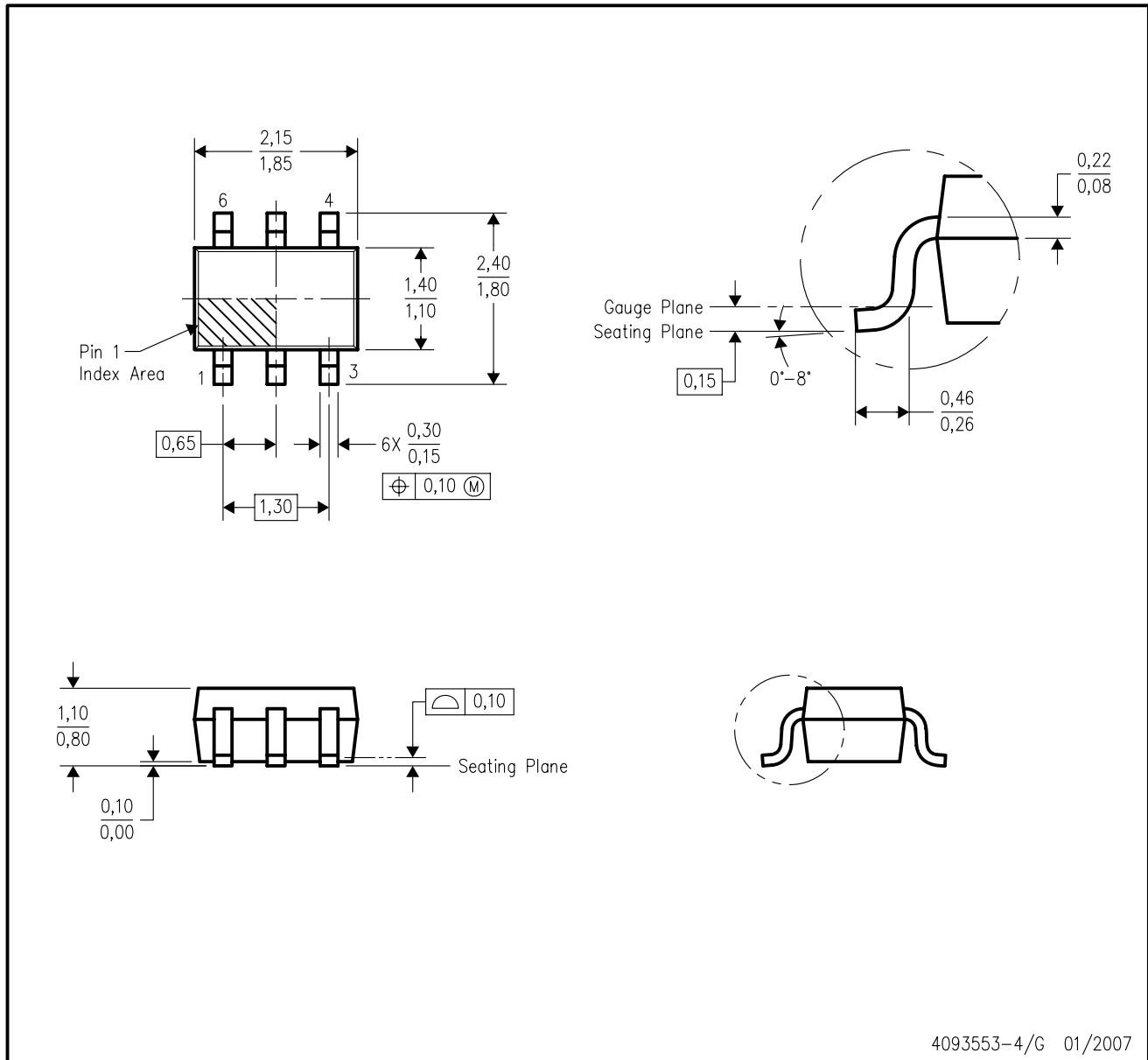

- NOTES:
- A. All linear dimensions are in millimeters.
  - B. This drawing is subject to change without notice.
  - C. Body dimensions do not include mold flash or protrusion. Mold flash and protrusion shall not exceed 0.15 per side.
  - D. Falls within JEDEC MO-203 variation AB.

DCK (R-PDSO-G6)

PLASTIC SMALL OUTLINE

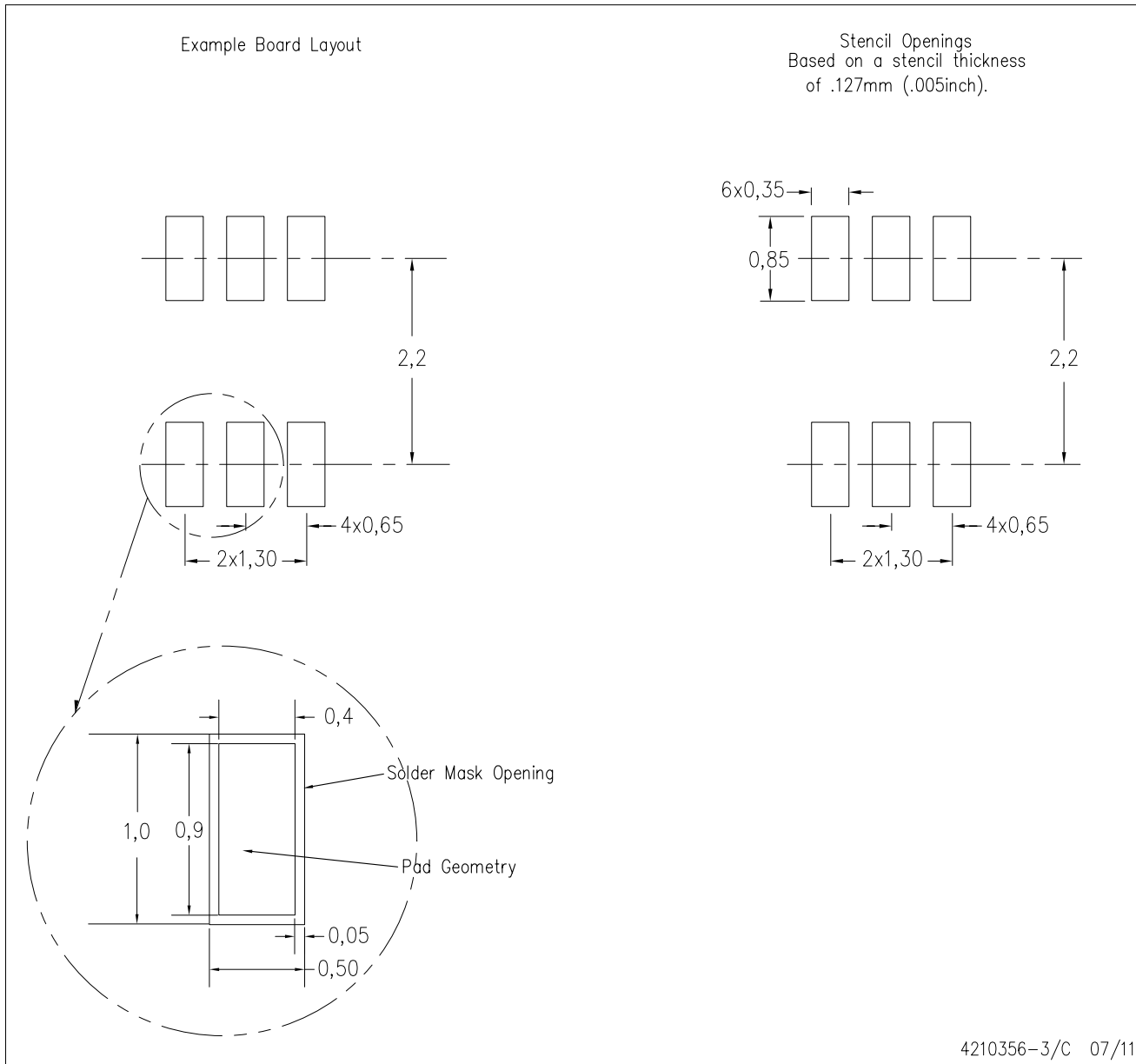

- NOTES:
- All linear dimensions are in millimeters.
  - This drawing is subject to change without notice.
  - Customers should place a note on the circuit board fabrication drawing not to alter the center solder mask defined pad.
  - Publication IPC-7351 is recommended for alternate designs.
  - Laser cutting apertures with trapezoidal walls and also rounding corners will offer better paste release. Customers should contact their board assembly site for stencil design recommendations. Example stencil design based on a 50% volumetric metal load solder paste. Refer to IPC-7525 for other stencil recommendations.



# EXAMPLE BOARD LAYOUT

DBV0005A

SOT-23 - 1.45 mm max height

SMALL OUTLINE TRANSISTOR



LAND PATTERN EXAMPLE  
EXPOSED METAL SHOWN  
SCALE:15X



SOLDER MASK DETAILS

4214839/D 11/2018

NOTES: (continued)

- 5. Publication IPC-7351 may have alternate designs.
- 6. Solder mask tolerances between and around signal pads can vary based on board fabrication site.

# EXAMPLE STENCIL DESIGN

DBV0005A

SOT-23 - 1.45 mm max height

SMALL OUTLINE TRANSISTOR



SOLDER PASTE EXAMPLE  
BASED ON 0.125 mm THICK STENCIL  
SCALE:15X

4214839/D 11/2018

NOTES: (continued)

7. Laser cutting apertures with trapezoidal walls and rounded corners may offer better paste release. IPC-7525 may have alternate design recommendations.
8. Board assembly site may have different recommendations for stencil design.

## GENERIC PACKAGE VIEW

LP 3

TO-92 - 5.34 mm max height

TRANSISTOR OUTLINE



Images above are just a representation of the package family, actual package may vary.  
Refer to the product data sheet for package details.

4040001-2/F

LP0003A



# PACKAGE OUTLINE

TO-92 - 5.34 mm max height

TO-92



4215214/B 04/2017

## NOTES:

1. All linear dimensions are in millimeters. Any dimensions in parenthesis are for reference only. Dimensioning and tolerancing per ASME Y14.5M.
2. This drawing is subject to change without notice.
3. Lead dimensions are not controlled within this area.
4. Reference JEDEC TO-226, variation AA.
5. Shipping method:
  - a. Straight lead option available in bulk pack only.
  - b. Formed lead option available in tape and reel or ammo pack.
  - c. Specific products can be offered in limited combinations of shipping medium and lead options.
  - d. Consult product folder for more information on available options.



LAND PATTERN EXAMPLE  
STRAIGHT LEAD OPTION  
NON-SOLDER MASK DEFINED  
SCALE:15X



LAND PATTERN EXAMPLE  
FORMED LEAD OPTION  
NON-SOLDER MASK DEFINED  
SCALE:15X

# TAPE SPECIFICATIONS

LP0003A

TO-92 - 5.34 mm max height

TO-92

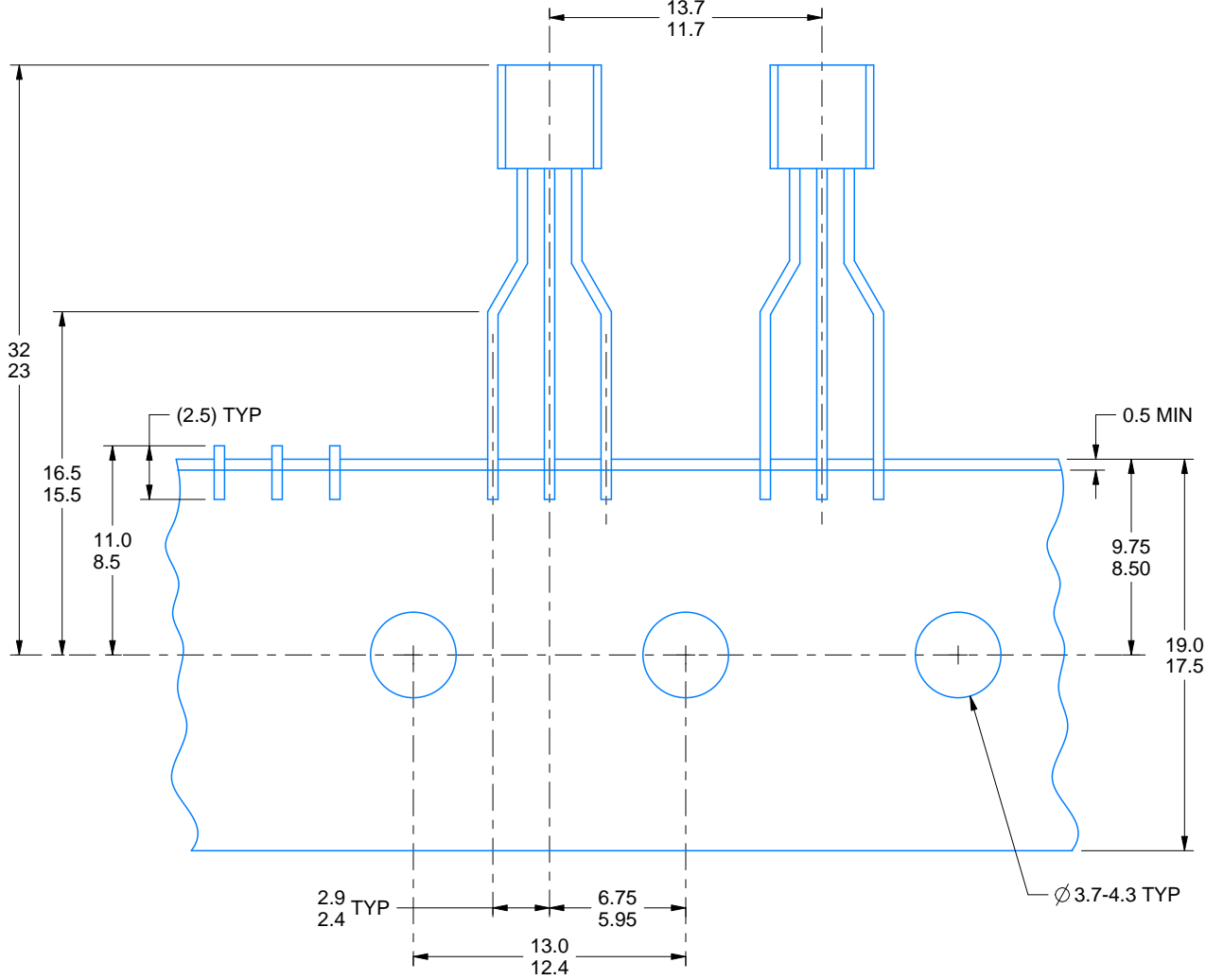

FOR FORMED LEAD OPTION PACKAGE

4215214/B 04/2017

## GENERIC PACKAGE VIEW

**DBZ 3**

**SOT-23 - 1.12 mm max height**

SMALL OUTLINE TRANSISTOR

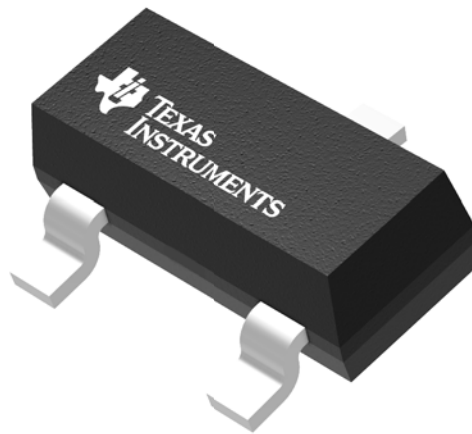

Images above are just a representation of the package family, actual package may vary.  
Refer to the product data sheet for package details.

4203227/C

DBZ0003A



# PACKAGE OUTLINE

SOT-23 - 1.12 mm max height

SMALL OUTLINE TRANSISTOR

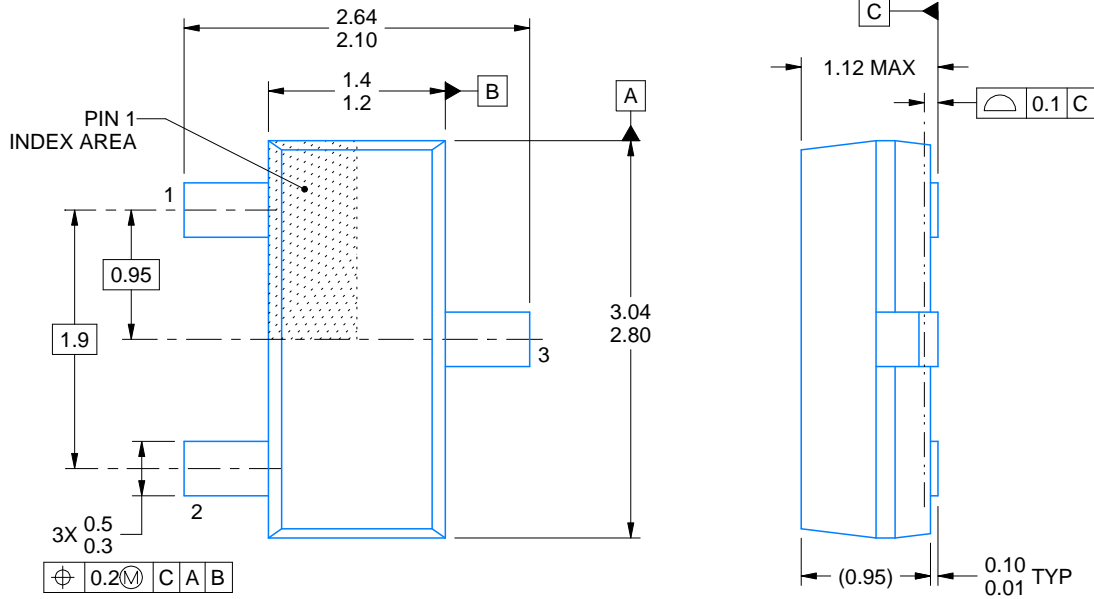

4214838/C 04/2017

NOTES:

1. All linear dimensions are in millimeters. Any dimensions in parenthesis are for reference only. Dimensioning and tolerancing per ASME Y14.5M.
2. This drawing is subject to change without notice.
3. Reference JEDEC registration TO-236, except minimum foot length.

# EXAMPLE BOARD LAYOUT

DBZ0003A

SOT-23 - 1.12 mm max height

SMALL OUTLINE TRANSISTOR

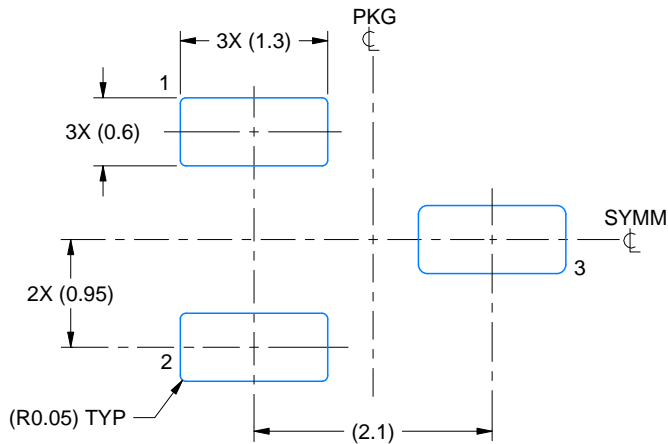

LAND PATTERN EXAMPLE  
SCALE:15X



SOLDER MASK DETAILS

4214838/C 04/2017

NOTES: (continued)

4. Publication IPC-7351 may have alternate designs.
5. Solder mask tolerances between and around signal pads can vary based on board fabrication site.

# EXAMPLE STENCIL DESIGN

DBZ0003A

SOT-23 - 1.12 mm max height

SMALL OUTLINE TRANSISTOR



SOLDER PASTE EXAMPLE  
BASED ON 0.125 THICK STENCIL  
SCALE:15X

4214838/C 04/2017

NOTES: (continued)

6. Laser cutting apertures with trapezoidal walls and rounded corners may offer better paste release. IPC-7525 may have alternate design recommendations.
7. Board assembly site may have different recommendations for stencil design.

## IMPORTANT NOTICE AND DISCLAIMER

TI PROVIDES TECHNICAL AND RELIABILITY DATA (INCLUDING DATASHEETS), DESIGN RESOURCES (INCLUDING REFERENCE DESIGNS), APPLICATION OR OTHER DESIGN ADVICE, WEB TOOLS, SAFETY INFORMATION, AND OTHER RESOURCES "AS IS" AND WITH ALL FAULTS, AND DISCLAIMS ALL WARRANTIES, EXPRESS AND IMPLIED, INCLUDING WITHOUT LIMITATION ANY IMPLIED WARRANTIES OF MERCHANTABILITY, FITNESS FOR A PARTICULAR PURPOSE OR NON-INFRINGEMENT OF THIRD PARTY INTELLECTUAL PROPERTY RIGHTS.

These resources are intended for skilled developers designing with TI products. You are solely responsible for (1) selecting the appropriate TI products for your application, (2) designing, validating and testing your application, and (3) ensuring your application meets applicable standards, and any other safety, security, or other requirements. These resources are subject to change without notice. TI grants you permission to use these resources only for development of an application that uses the TI products described in the resource. Other reproduction and display of these resources is prohibited. No license is granted to any other TI intellectual property right or to any third party intellectual property right. TI disclaims responsibility for, and you will fully indemnify TI and its representatives against, any claims, damages, costs, losses, and liabilities arising out of your use of these resources.

TI's products are provided subject to TI's Terms of Sale ([www.ti.com/legal/termsofsale.html](http://www.ti.com/legal/termsofsale.html)) or other applicable terms available either on [ti.com](http://ti.com) or provided in conjunction with such TI products. TI's provision of these resources does not expand or otherwise alter TI's applicable warranties or warranty disclaimers for TI products.

Mailing Address: Texas Instruments, Post Office Box 655303, Dallas, Texas 75265  
Copyright © 2019, Texas Instruments Incorporated

## Looking for pricing, stock, or lifecycle information?

Click below to explore more details on WIN SOURCE:

 [View TLVH431ACDBVT on WIN SOURCE](#)

 [Texas Instruments](#) Information

## Optimize Your Supply Chain with WIN SOURCE Solutions

-  Global Sourcing Solution
-  Obsolete Management
-  Cost Control Management
-  Shortage Management
-  Alternative Solution
-  Excess Inventory Management